

## DETAILS

<b>Product Number</b>	CS14263_HB-IP-2X6-WWW
<b>Family</b>	High Bay
<b>Type</b>	Assembly
<b>Color</b>	clear
<b>Diameter</b>	71,4 x 173 mm
<b>Height</b>	11,39 mm
<b>Style</b>	rectang
<b>Optic Material</b>	PMMA
<b>Holder Material</b>	
<b>Fastening</b>	screw
<b>Status</b>	production ready
<b>ROHS Compliant</b>	Yes
<b>Date Updated</b>	8/09/2016



## OPTICAL PROPERTIES

LED	Viewing	Light	Effi-		Connector
	Angle	Beam	ciency	cd/lm	
XP-G2	95 deg	HighBay	93 %	0.400	-
XT-E	98 deg	HighBay	94 %	0.380	-
XP-L	103 deg	HighBay	92 %	0.350	-
XM-L2	97 deg	HighBay	93 %	0.380	-
XHP35 HD	sim: 101	HighBay	sim: 91 %	sim: 0.360	-
XP-G3	sim: 95	HighBay	sim: 91 %	sim: 0.360	-
MHB-A	sim: 106	HighBay	sim: 87 %	sim: 0.360	-
XP-L2	96 deg	HighBay	94 %	0.390	-
H35C1 (LEMWA33)	sim: 101	HighBay	sim: 94 %	sim: 0.400	-
LUXEON T	91 deg	HighBay	93 %	0.440	-
LUXEON TX	95 deg	HighBay	93 %	0.430	-
LUXEON Z ES	85 deg	HighBay	93 %	0.470	-
LUXEON XR-TX (L2T0-xyy012M)	97 deg	HighBay	93 %	0.430	-
NVSxx19B/NVSxx19C	sim: 97	HighBay	sim: 92 %	sim: 0.380	-
NVSxE21A	84 deg	HighBay	94 %	0.480	-
Oslon Square PC	95 deg	HighBay	92 %	0.380	-
Oslon Square Gen3	sim: 95	HighBay	sim: 93 %	sim: 0.400	-
Duris S8	sim: 93	HighBay	sim: 94 %	sim: 0.440	-
Oslon SSL 80	76 deg	HighBay	94 %	0.560	-
Duris P9	sim: 98	HighBay	sim: 94 %	sim: 0.390	-
Z5M1/Z5M2	97 deg	HighBay	92 %	0.400	-
TL1L3	sim: Asymmetric	HighBay	sim: 84 %	-	-
TL1L2	sim: 100	HighBay	sim: 91 %	sim: 0.390	-
TL1L4	95 deg	HighBay	94 %	0.410	-

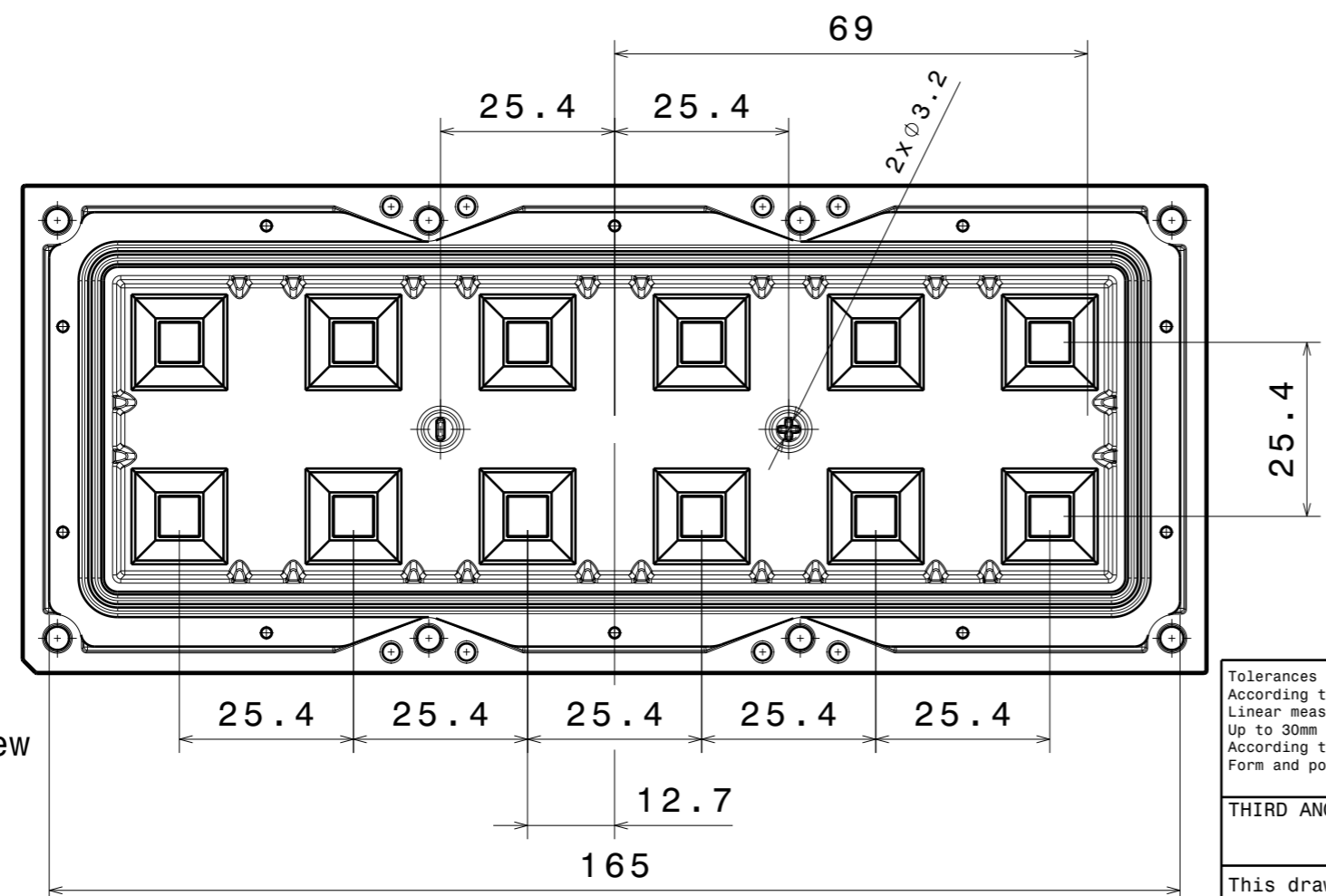
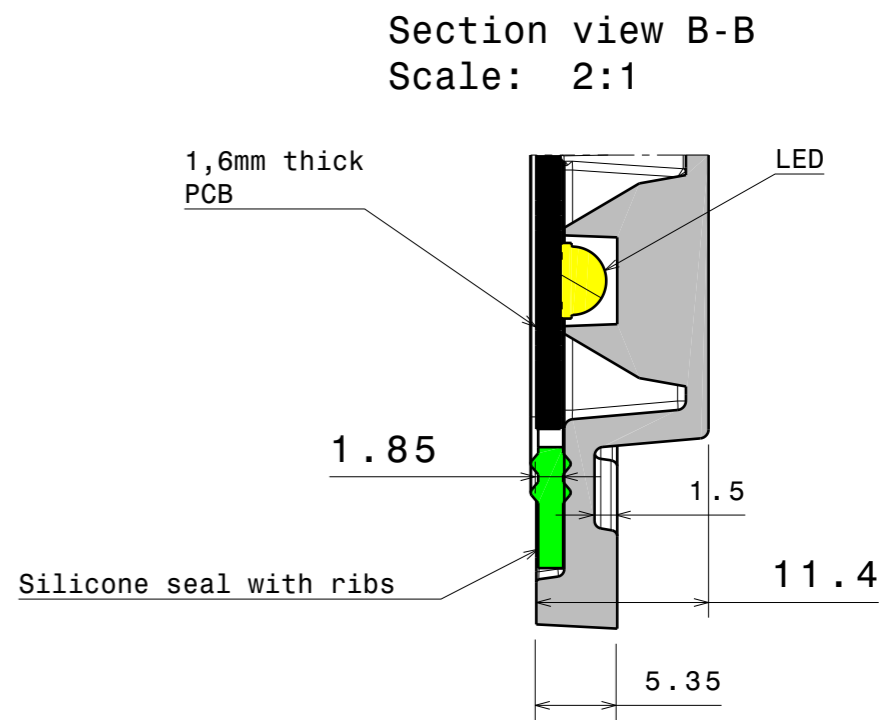
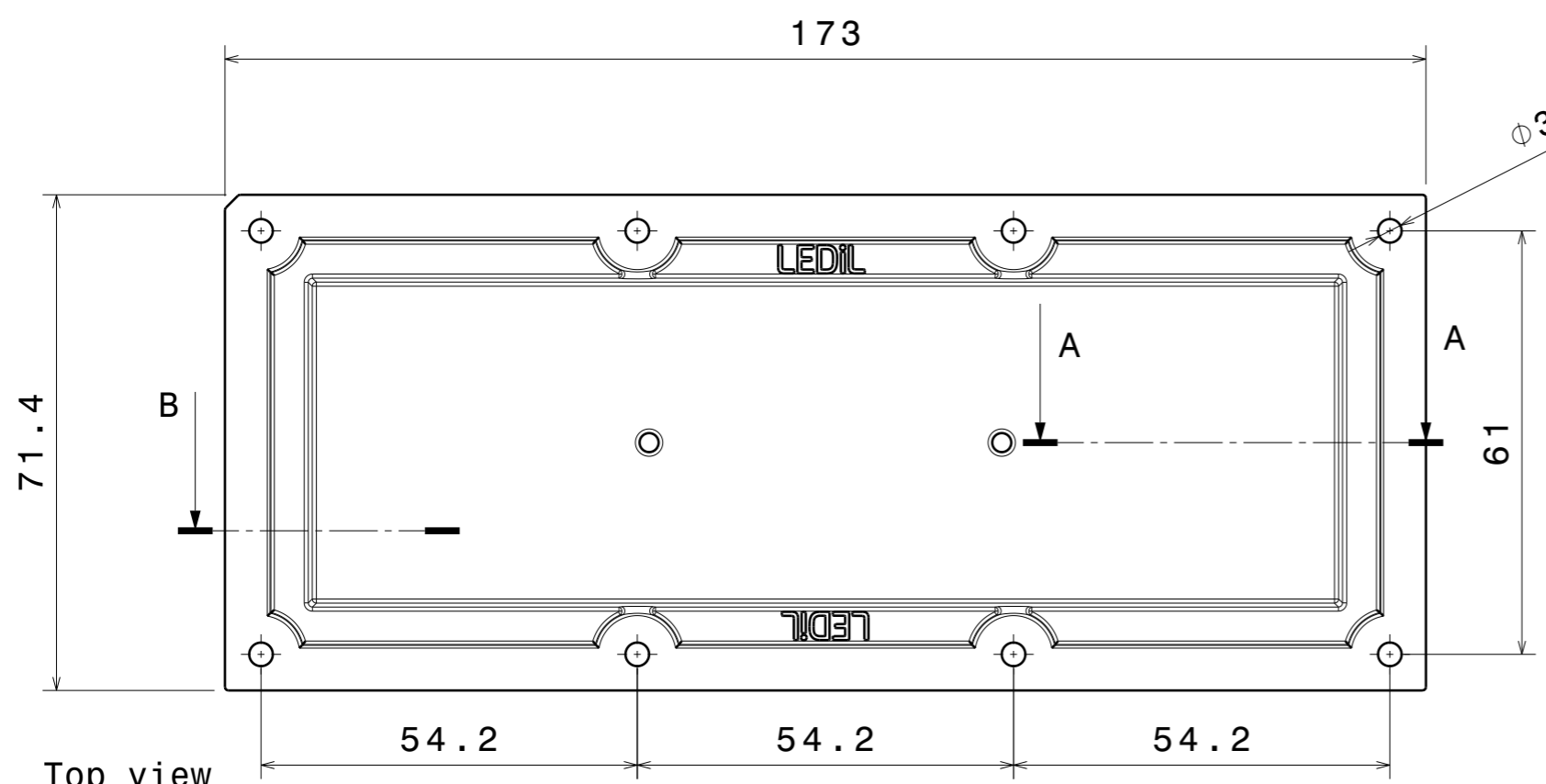

Section view A-A

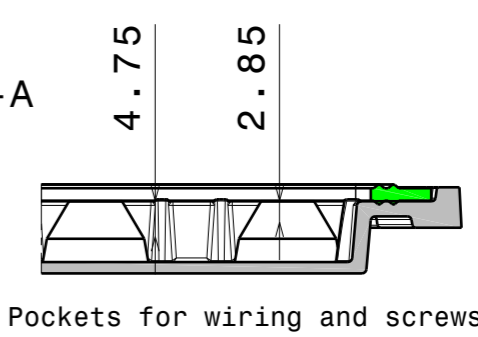

INDEX	PART NO	DESCRIPTION	MATERIAL	COLOUR
1	C14229	HB-IP-2X6-WWW	PMMA	clear
2	C14018	2x6-SEAL25	Silicone	white

Tolerances if not otherwise shown  
According to DIN ISO 2768-1  
Linear measures:  
Up to 30mm class M, otherwise class C.  
According to DIN ISO 2768-2  
Form and position: class L

**LEDiL** LediL Oy  
Salorankatu 10  
FIN 24240 SALO  
Finland

THIRD ANGLE PROJECTION:

DRAWING TITLE  
**CS14263\_HB-IP-2X6-WWW**

This drawing is the property of LEDiL Oy. It may not be reproduced, copied or communicated without a written agreement with LEDiL Oy.

SIZE	PART NUMBER		
<b>A3</b>	<b>CS14263</b>		

SCALE	1:1	WEIGHT	62,2 g	SHEET	1/1
-------	-----	--------	--------	-------	-----

Luminaire: LEDiL Oy CS14263\_HB-IP-2X6-WWW\_(XP-G2)

Lamps: 1 x CREE\_XP-G2\_2x6\_1180.76lm@250mA\_P=8.13864W\_I=240mA

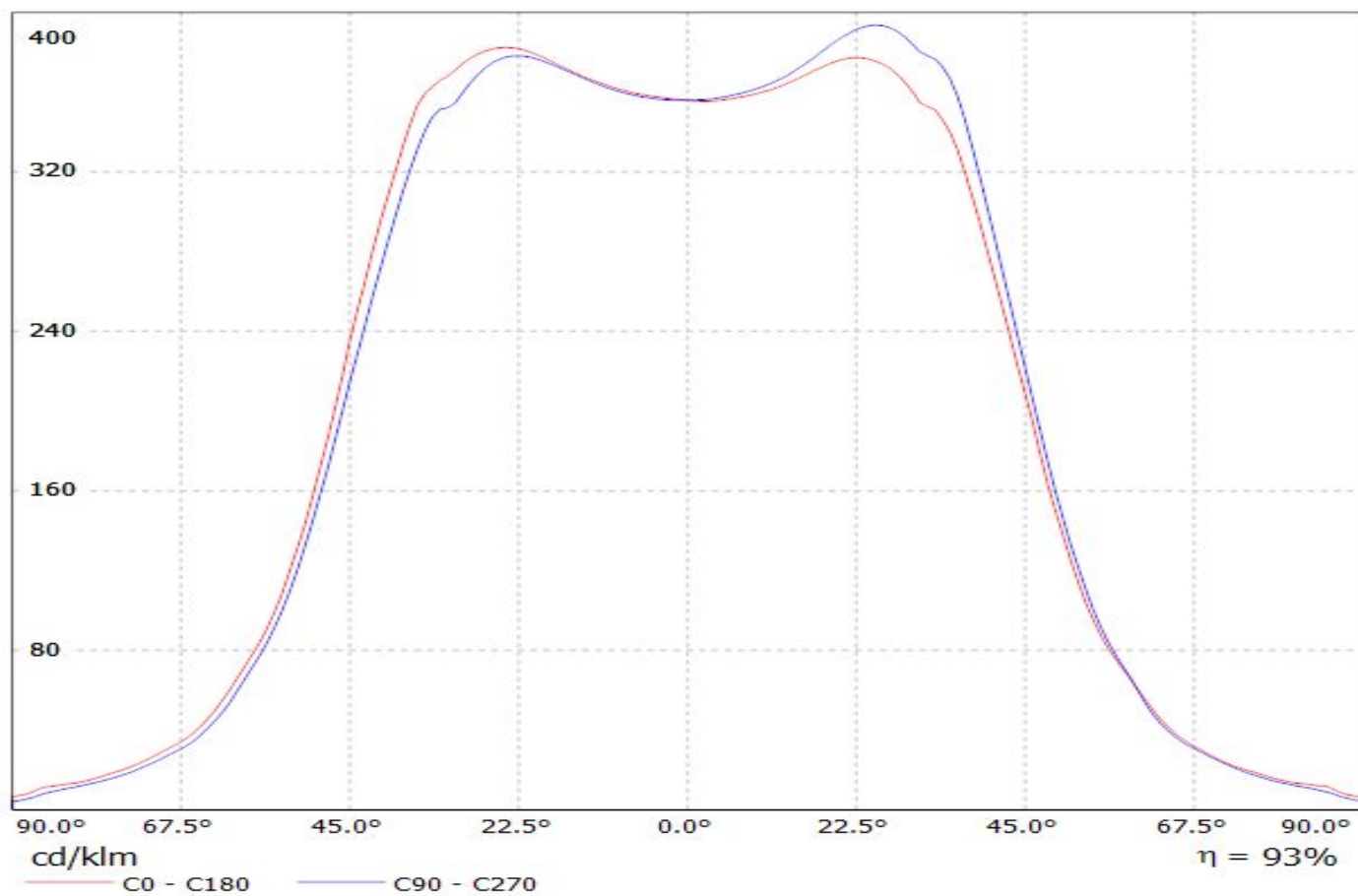

Luminaire: LEDiL Oy CS14263\_HB-IP-2X6-WWW\_(XT-E)

Lamps: 1 x CREE\_XT-E\_6x2\_(XTEAWT-00-0000-000000HE4)\_1253.02lm@250mA\_P=8.85391W\_I=249.8mA

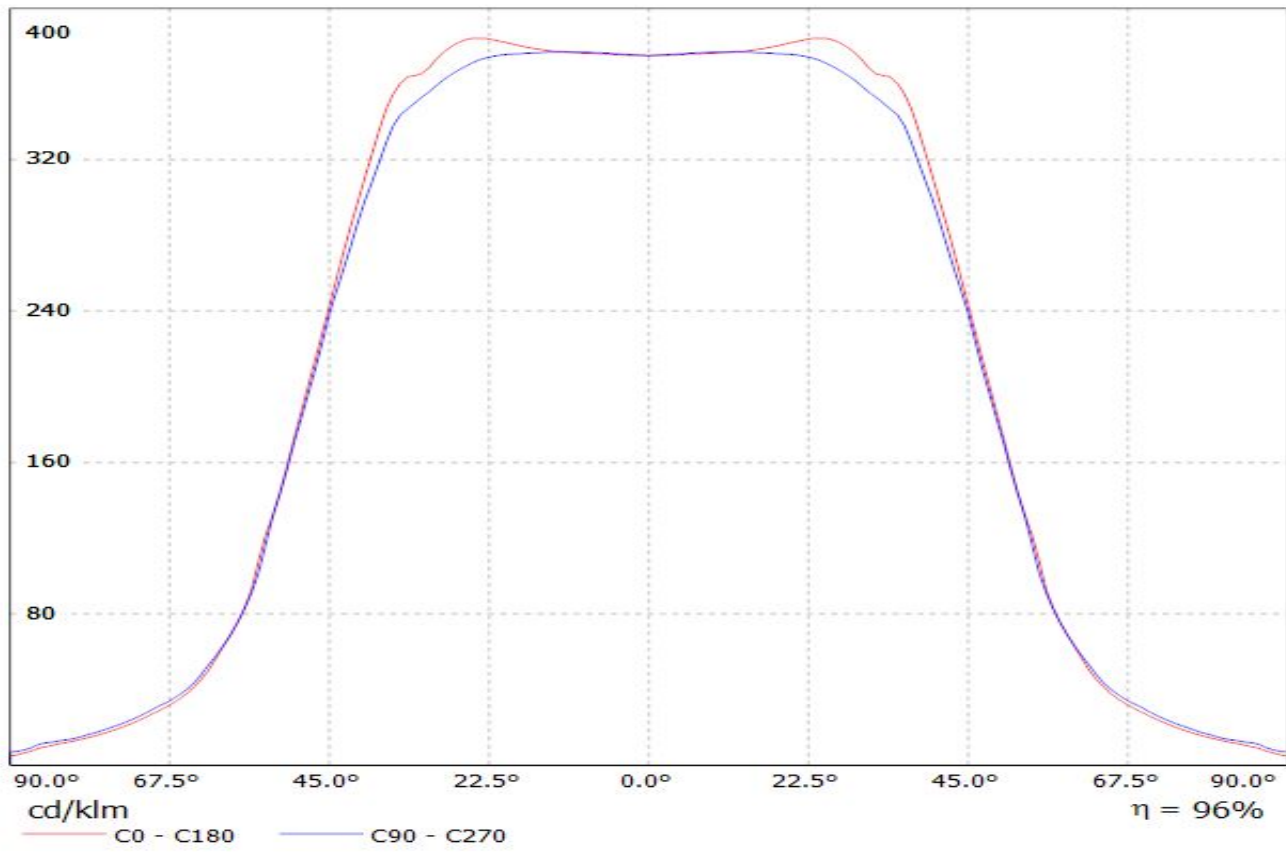

Luminaire: LEDiL Oy CS14263\_HB-IP-2X6-WWW\_(XP-L)

Lamps: 1 x CREE\_XP-L\_2x6\_(XPLAWT-0-7A3-U50-0H-0001)\_1253.88lm@250mA\_P=8.22317W\_I=249.8mA

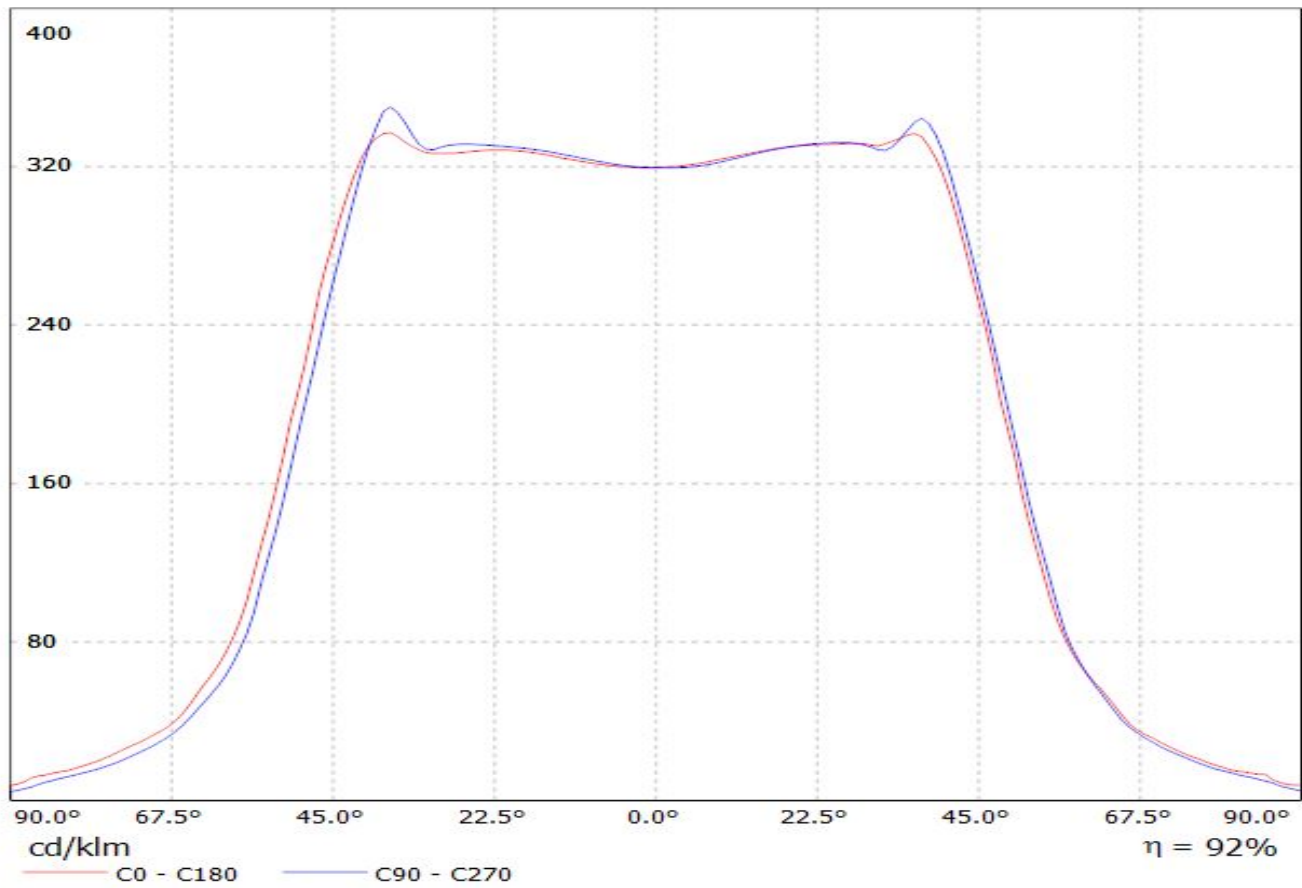

Luminaire: LEDiL Oy CS14263\_HB-IP-2X6-WWW\_(XM-L2) Eff.92.6%  
Lamps: 1 x CREE\_XM-L2\_2x6\_1197.78lm@250mA\_P=8.38555W\_I=254.1mA

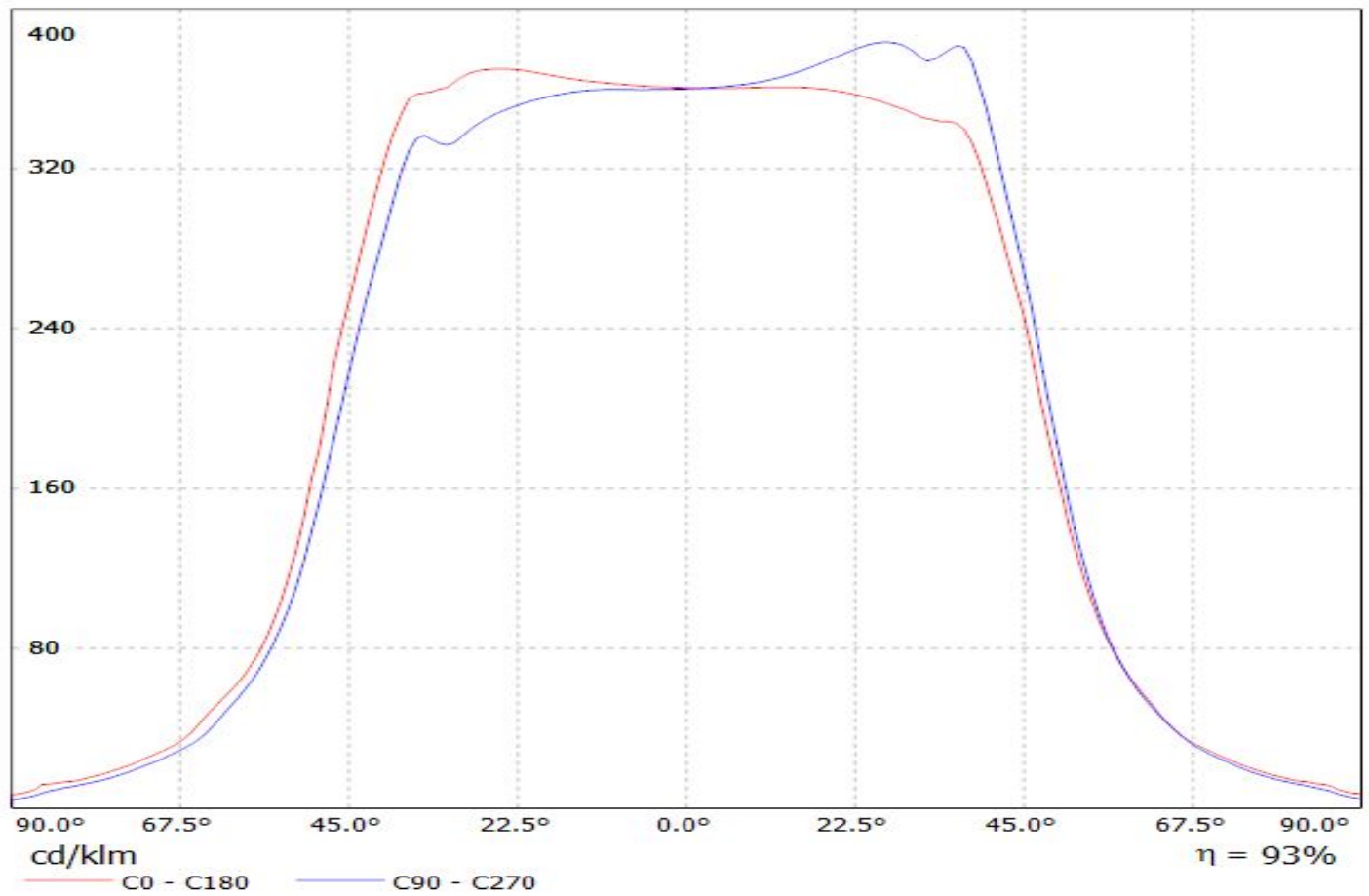

Luminaire: Ledil Oy CS14263\_HB-IP-2X6-WWW\_(XP-G3)\_SIMULATED  
Lamps: 1 x Cree XP-G3

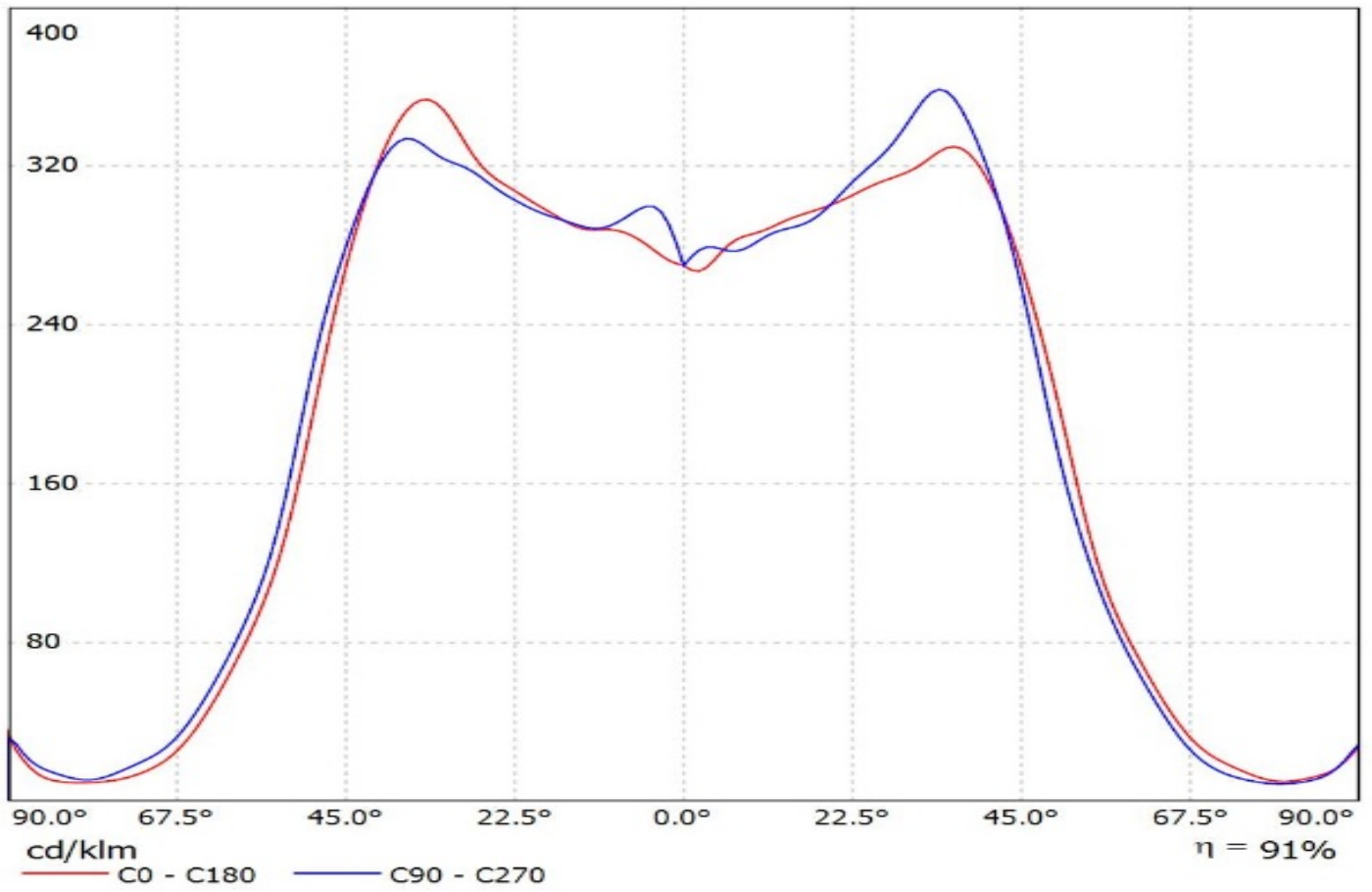

Luminaire: LEDIL CS14263\_HB-IP-2X6-WWW\_MHB\_SIMULATED  
Lamps: 1 x

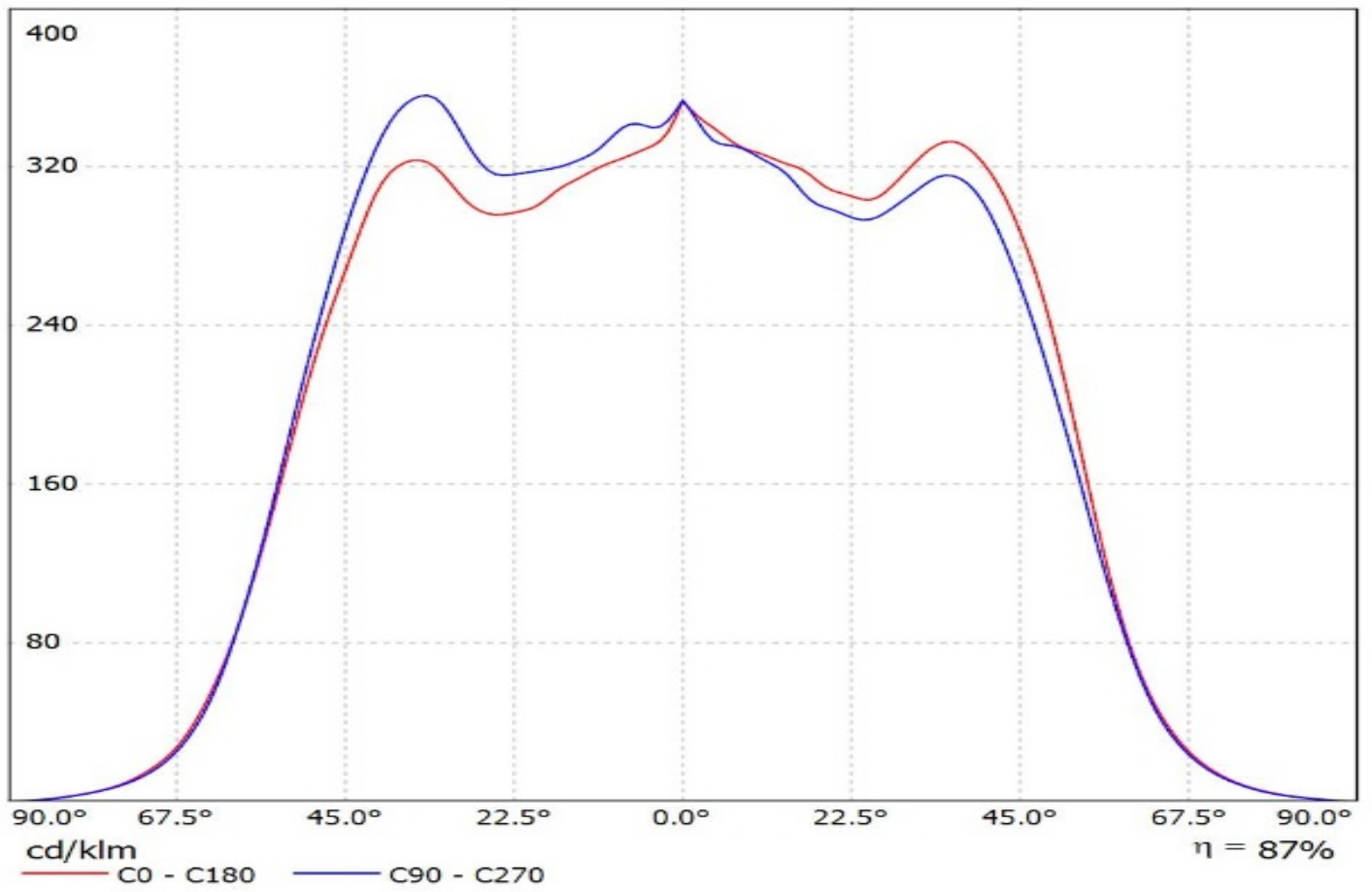



Luminaire: Ledil CS14263\_HB-IP-2X6-WWW\_(XP-L2)  
Lamps: 1 x Cree\_XP-L2\_2x6\_1659.4lm@250mA\_P=8.22525W\_I=0.25A

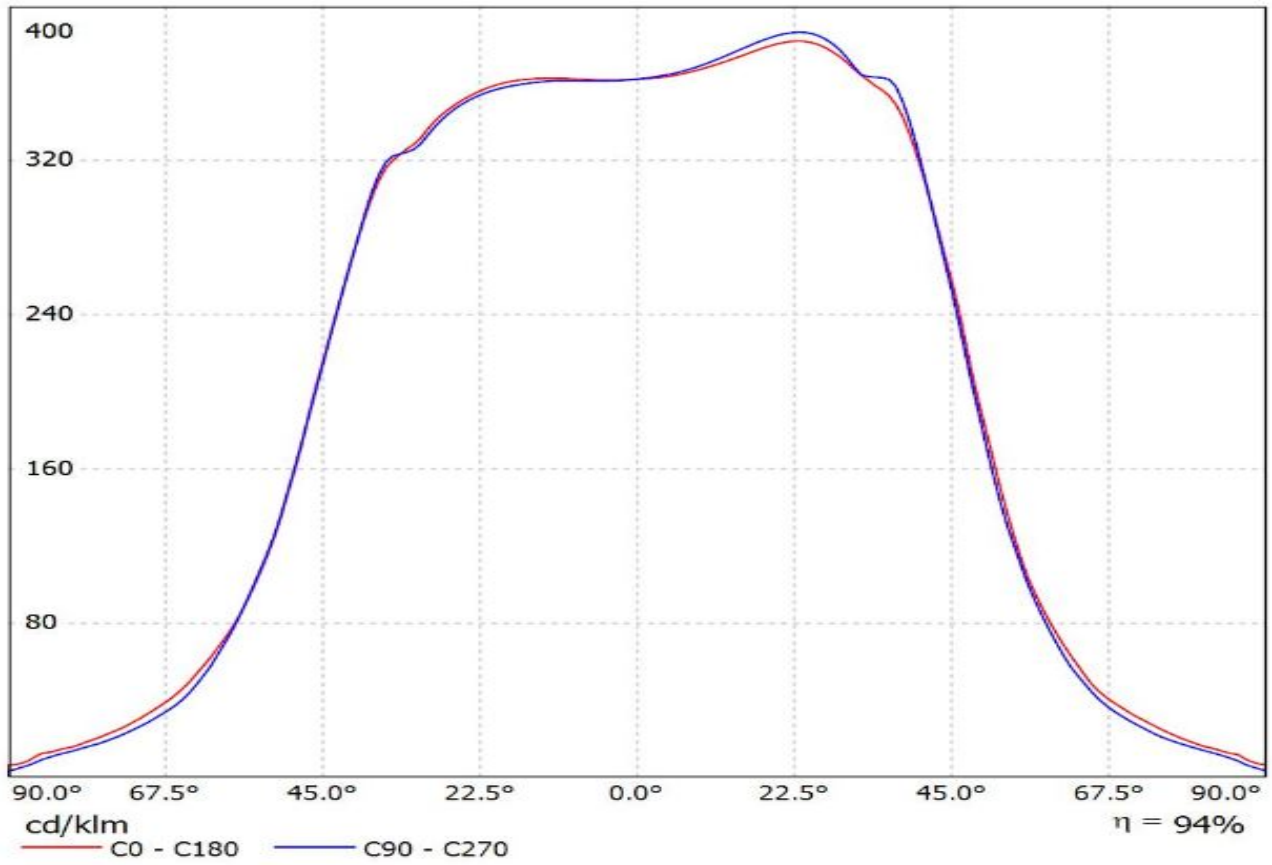

Luminaire: Ledil Oy CS14263\_HB-IP-2X6-WWW\_(H35C1)\_SIMULATED  
Lamps: 1 x LG H35C1

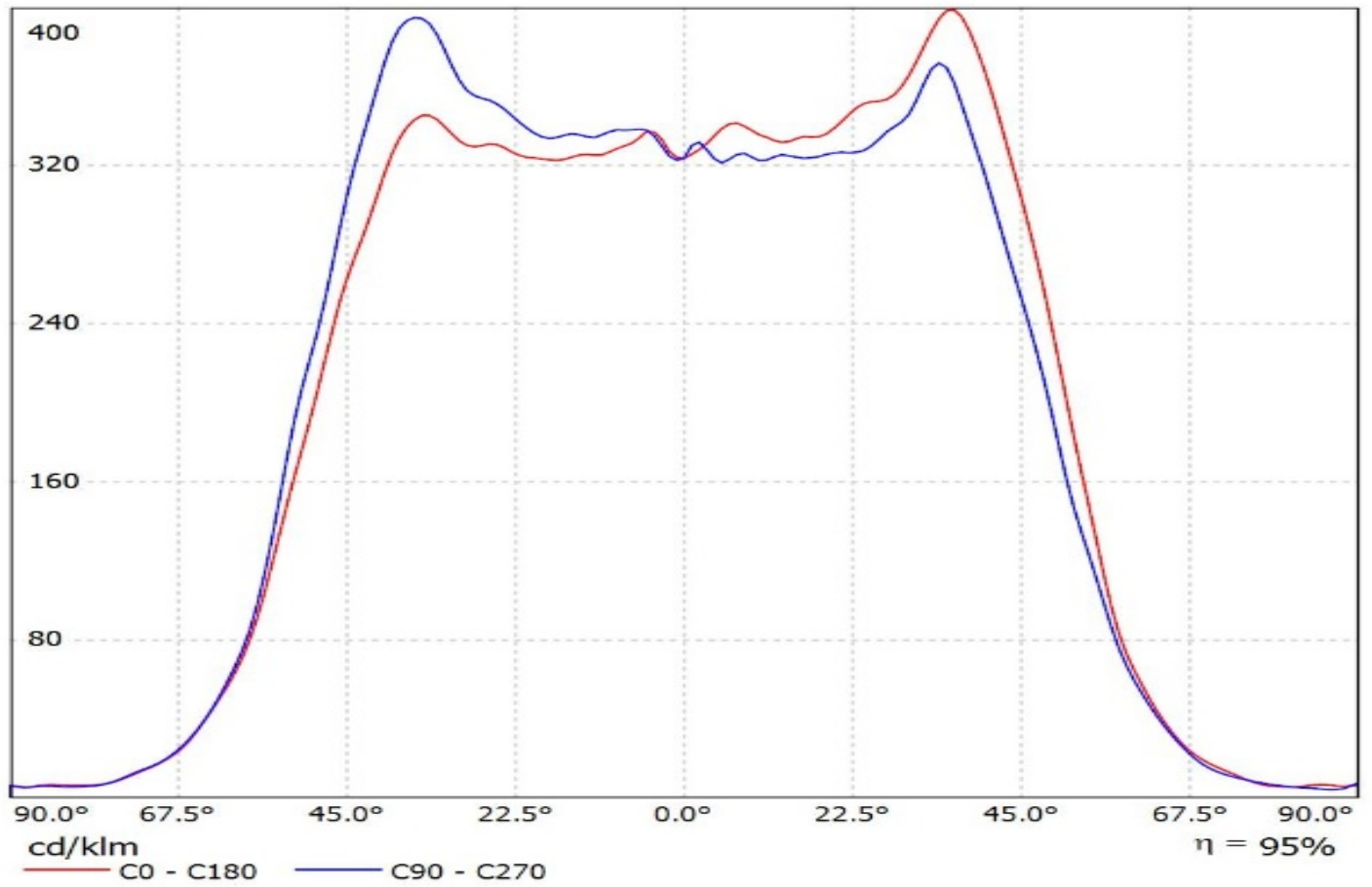

Luminaire: LEDiL Oy CS14263\_HB-IP-2X6-WWW\_(Luxeon\_T)  
Lamps: 1 x Luxeon\_T\_2x6\_(LXH8-FW30)\_1010lm@250mA\_P=8.39003W\_I=249.8mA

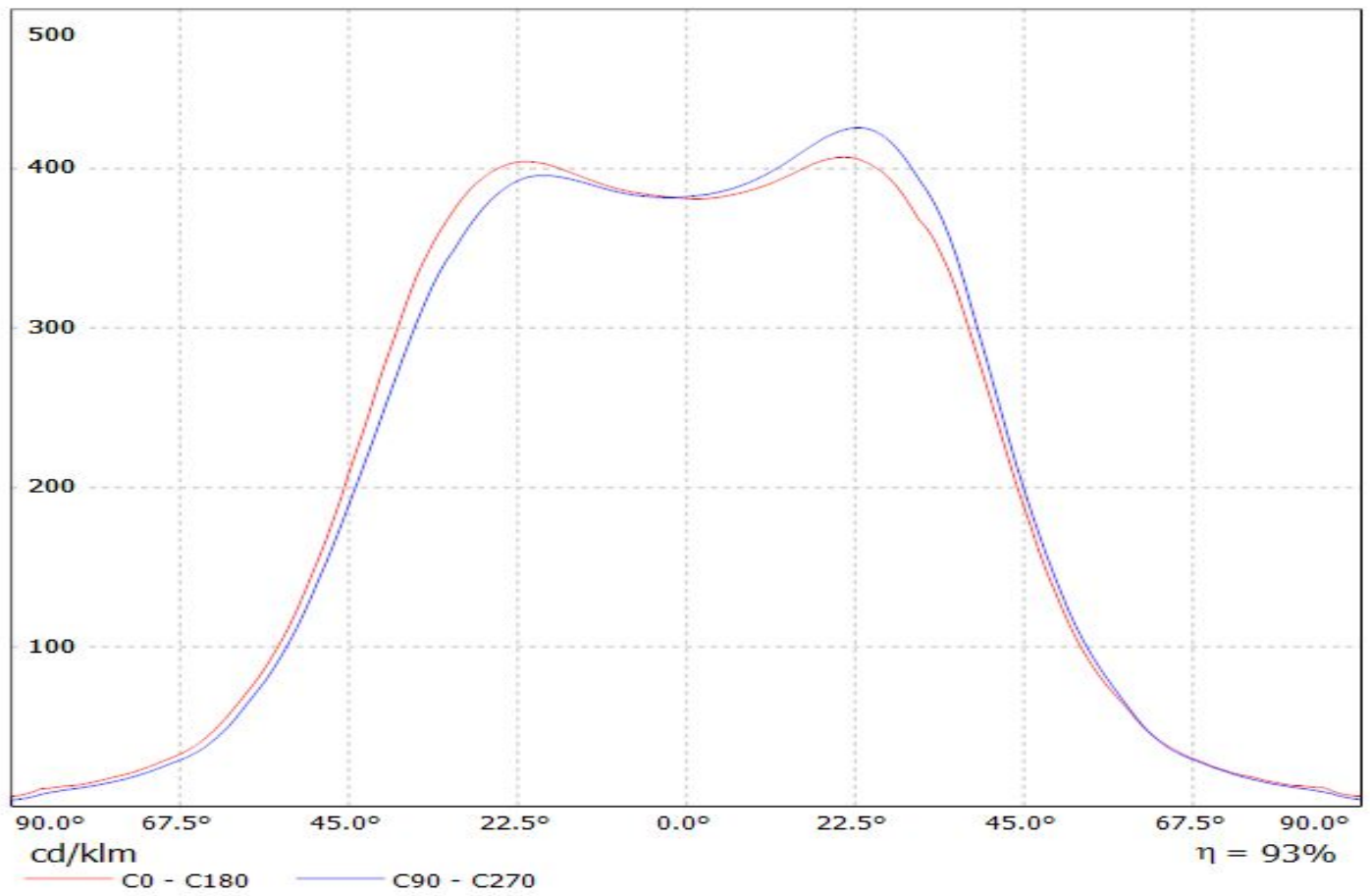

Luminaire: LEDiL Oy CS14263\_HB-IP-2X6-WWW\_(Luxeon\_TX)  
Lamps: 1 x Luxeon\_TX\_2x6\_1286.09lm@250mA\_P=8.26138W\_I=249.8mA

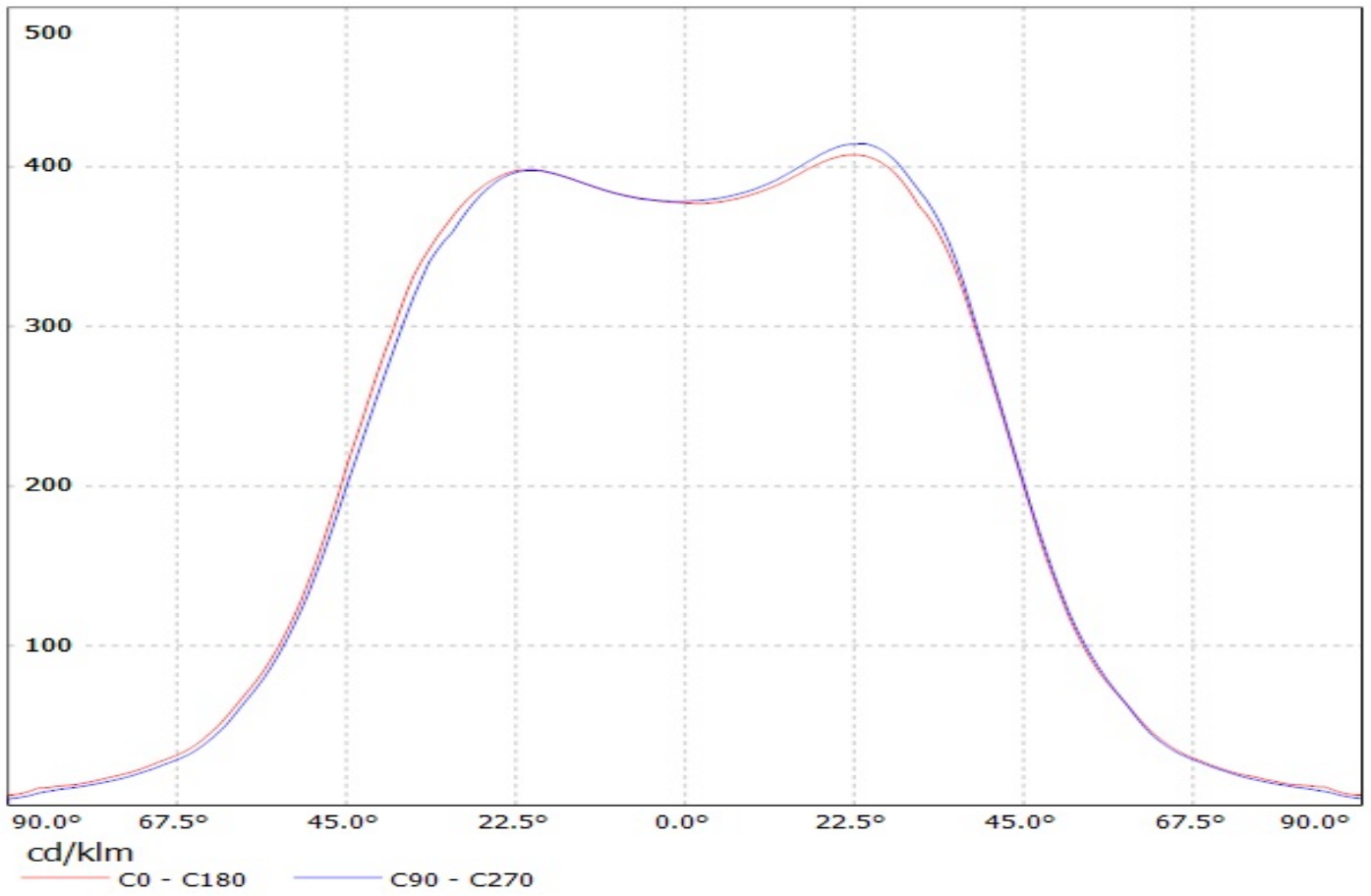

Luminaire: LEDiL Oy CS14263\_HB-IP-2X6-WWW\_(Luxeon\_Z\_ES)  
Lamps: 1 x LUXEON\_Z\_ES\_2x6\_967.781lm@250mA\_P=8.25189W\_I=249.8mA

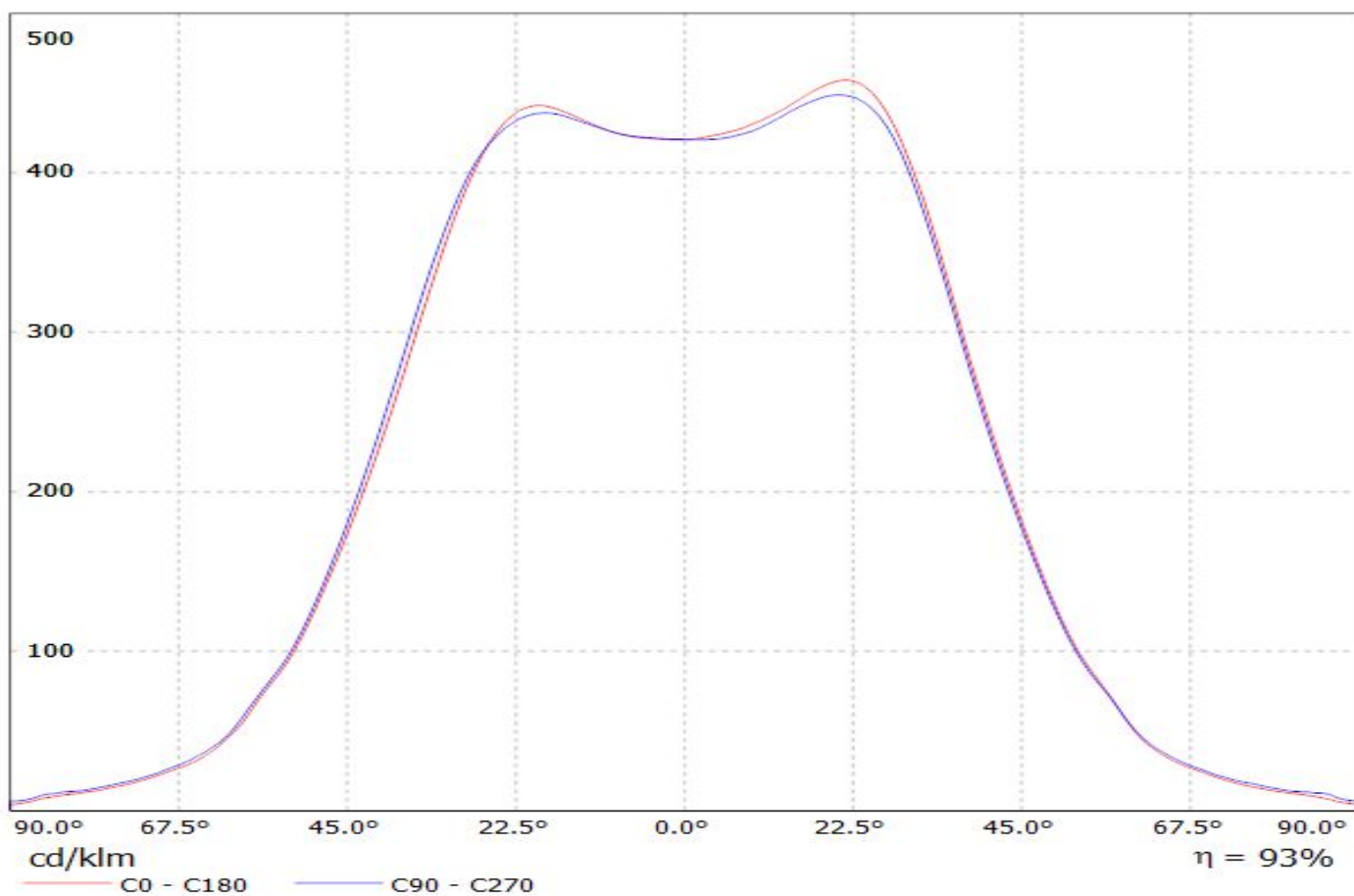

Luminaire: Ledil CS14263\_HB-IP-2X6-WWW\_(XR-TX)  
Lamps: 1 x Luxeon\_XR-TX\_1376.41lm@250mA\_P=8.3920W\_I=0.250A

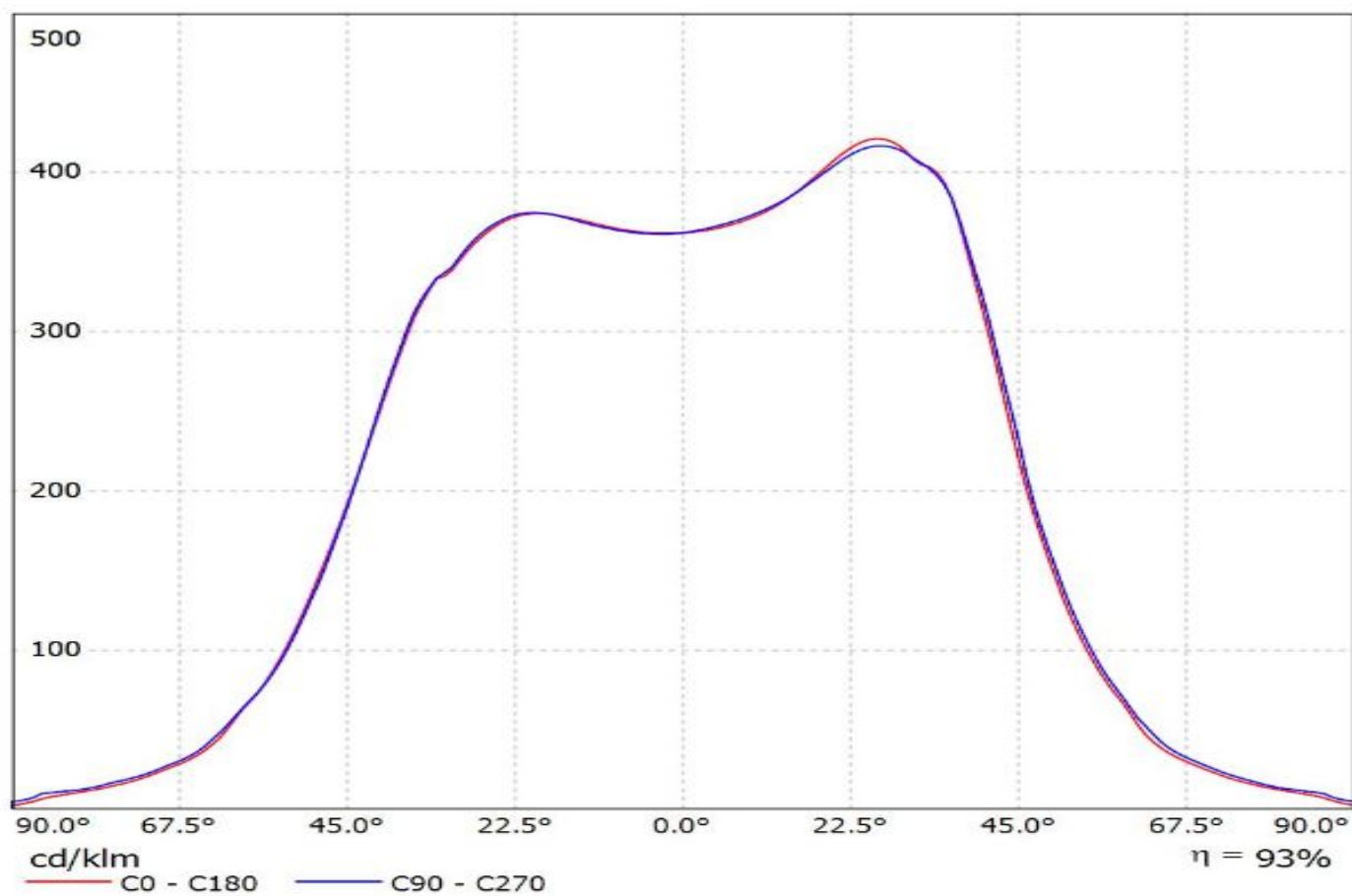

Luminaire: Ledil CS14263\_HB-IP-2X6-WWW\_(Nichia\_E21)

Lamps: 1 x Nichia\_NVSWE21A\_601.623lm@600mA\_P=3.5001W\_I=0.600A

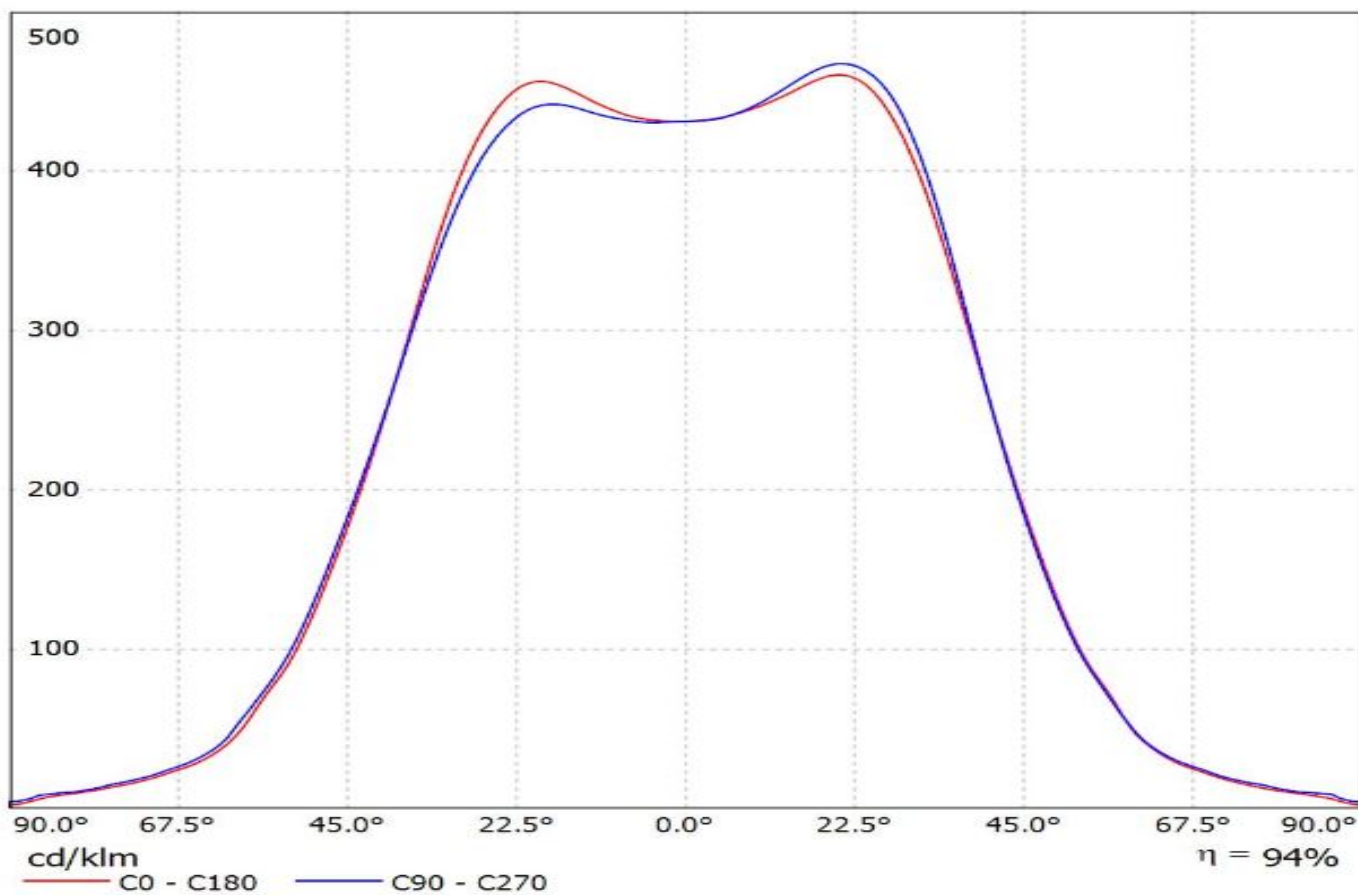

Luminaire: LEDiL Oy CS14263\_HB-IP-2X6-WWW\_(SQ-PC)

Lamps: 1 x OSLO<sub>N</sub>\_SQUARE-PC\_1186.1lm@250mA\_P=8.73326W\_I=249.8mA

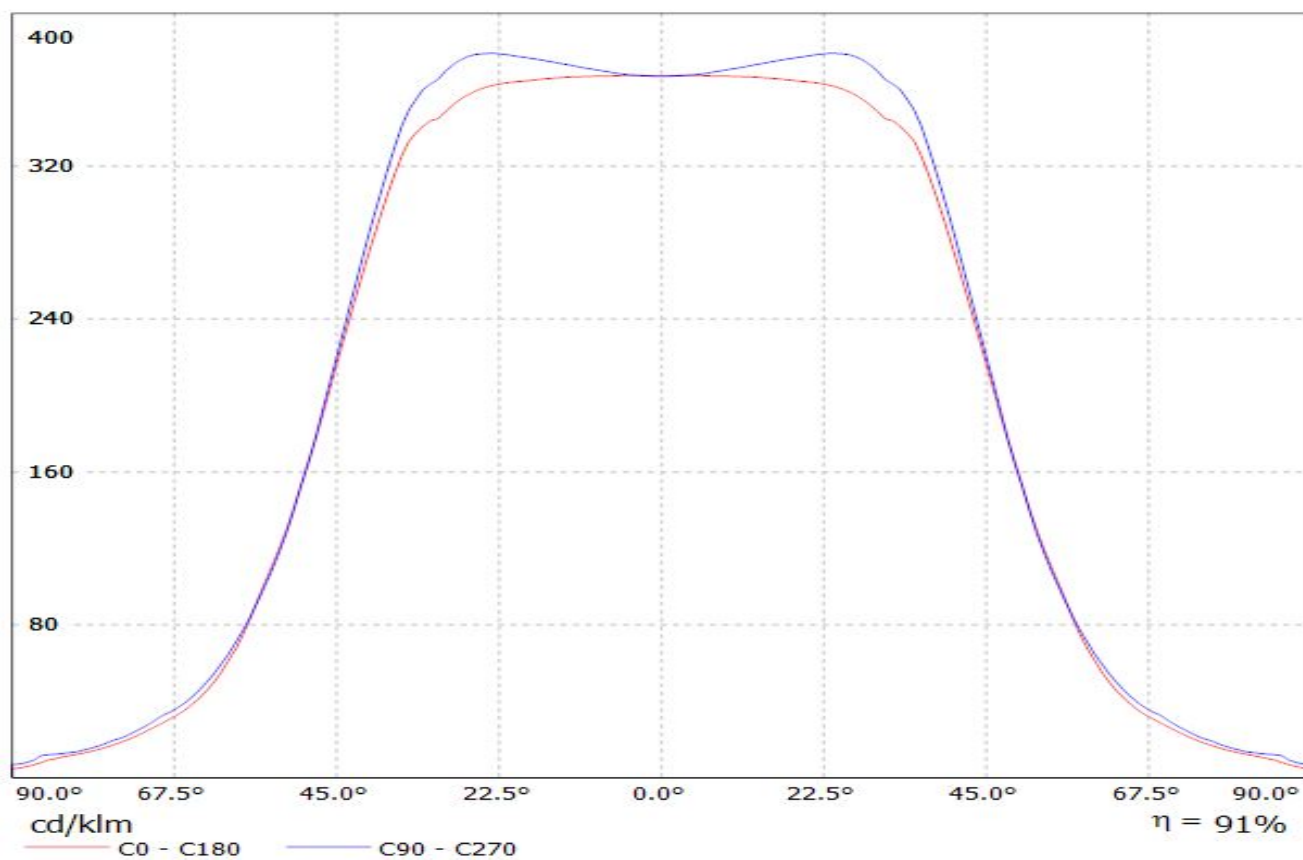



Luminaire: LEDiL Oy CS14263\_HB-IP-2X6-WWW\_(SSL80)  
Lamps: 1 x SSL80\_1292.29lm@250mA\_P=8.5574W\_I=0.250A

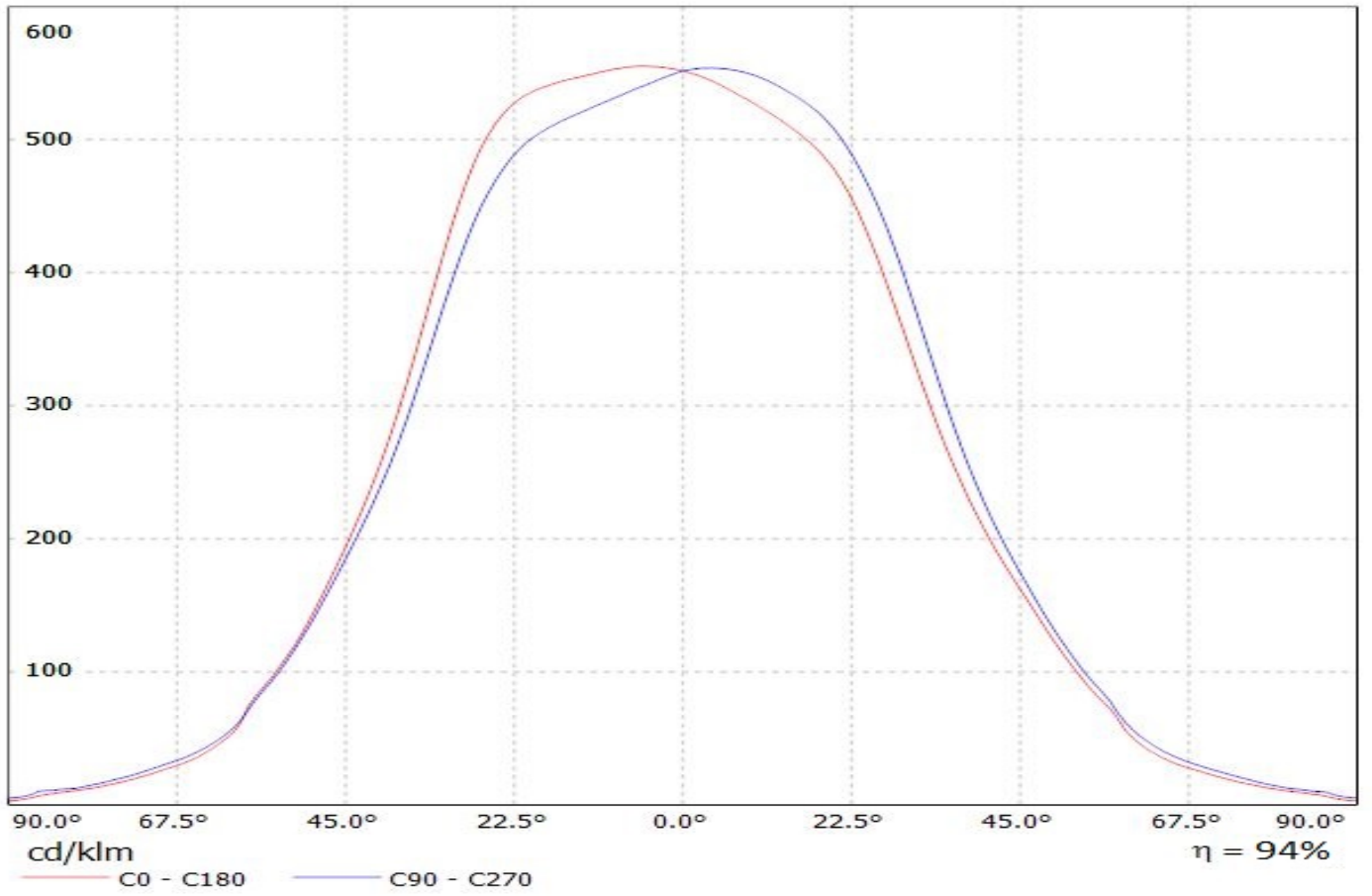

Luminaire: Ledil Oy CS14263\_HB-IP-2X6-WWW\_OSRAM\_DURIS\_P9\_SIMULATED  
Lamps: 1 x OSRAM DURIS P9

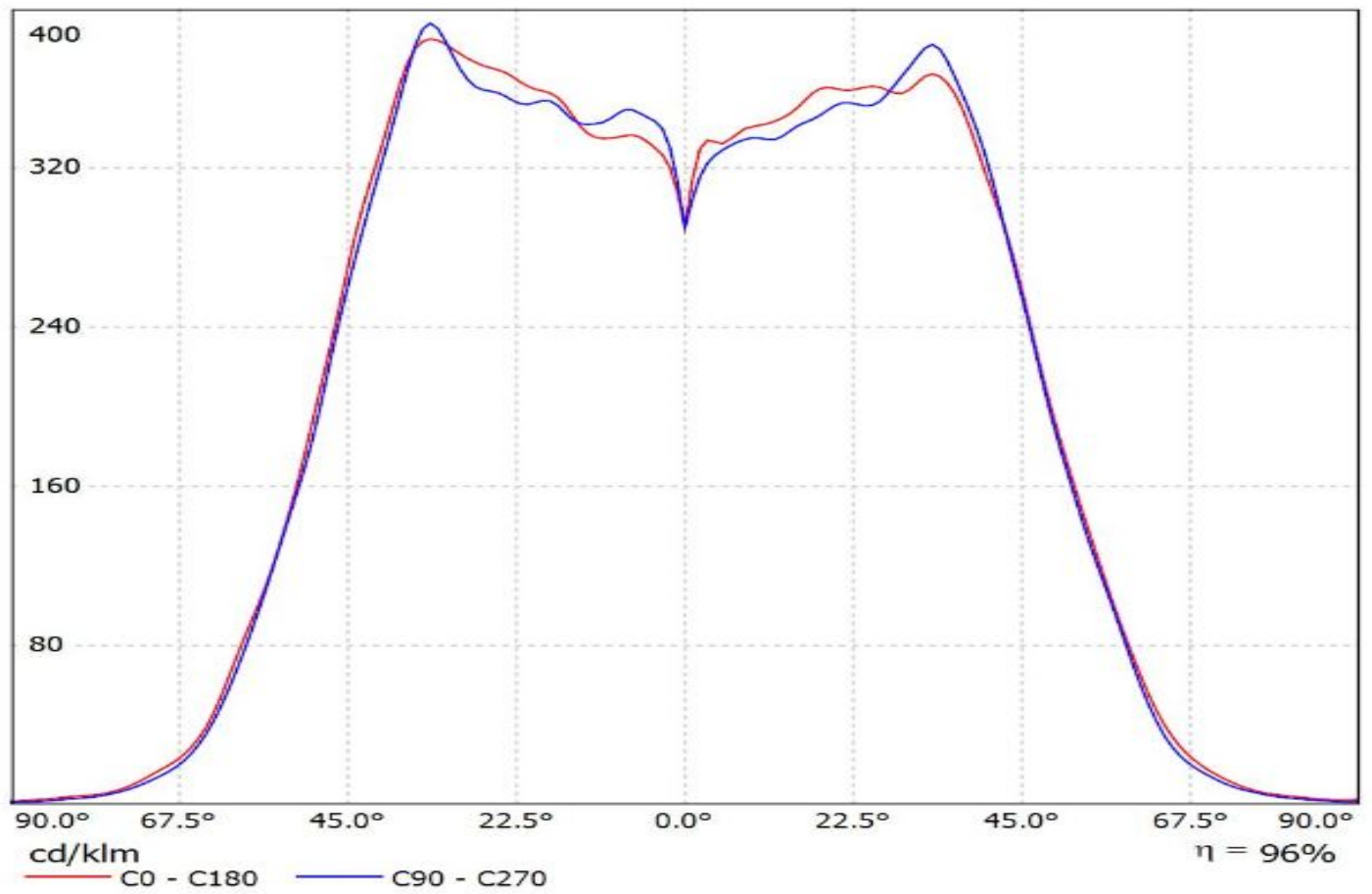

Luminaire: Ledil CS14263\_HB-IP-2X6-WWW\_(Z5M1)\_GS

Lamps: 1 x Seoul Z5M1 (S25-M1-WW-C8)\_1201.44lm@250mA\_P=8.63825W\_I=0.25A

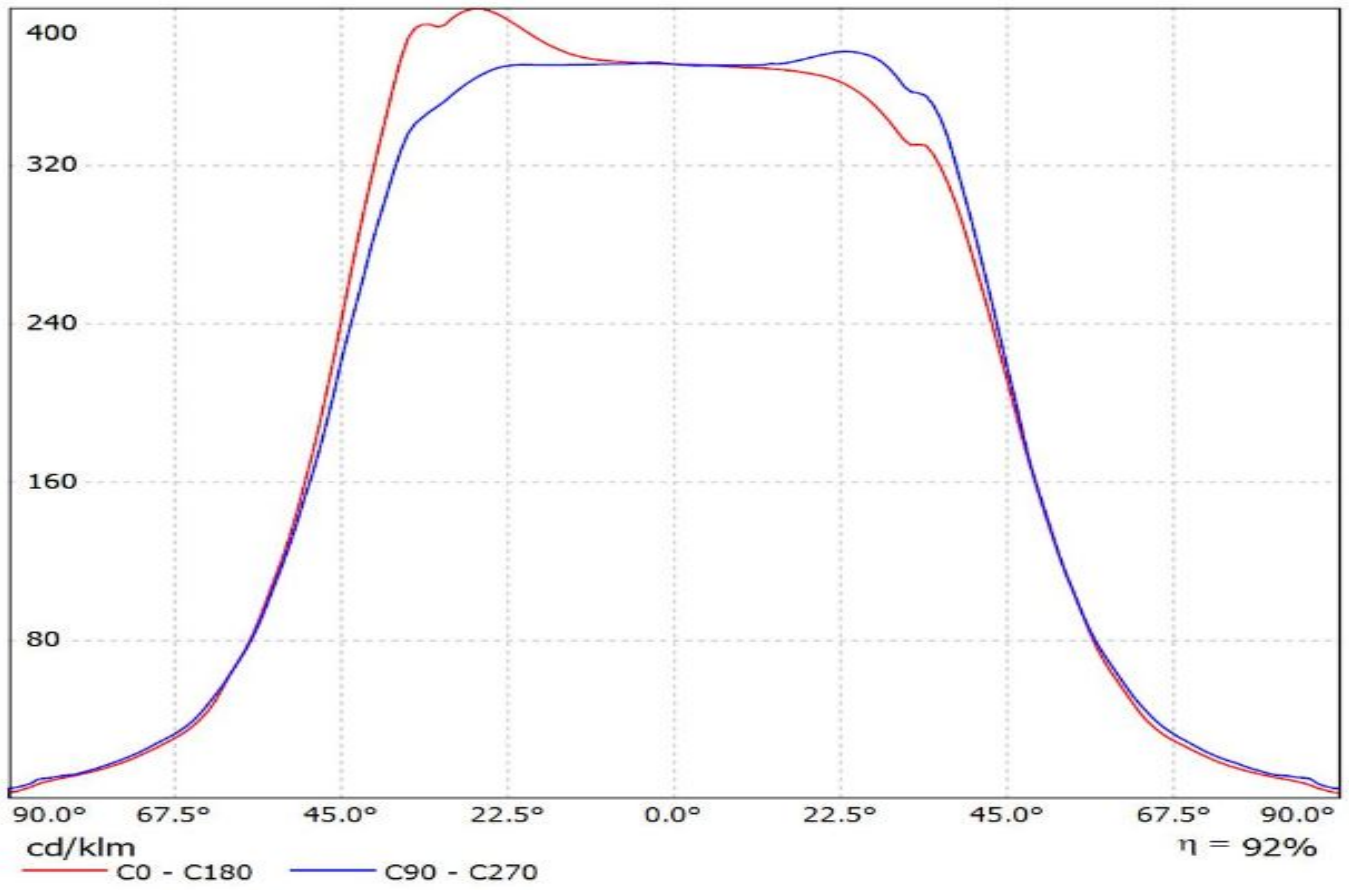

# Ledil CS14263\_HB-IP-2X6-WWW\_(TL1L4) / LDC (Linear)

Luminaire: Ledil CS14263\_HB-IP-2X6-WWW\_(TL1L4)

Lamps: 1 x Toshiba\_TL1L4\_2x6\_(TL1L4-DW0)\_1263.19lm@250mA\_CCT=6500K\_P=8.5W\_I=0.25A

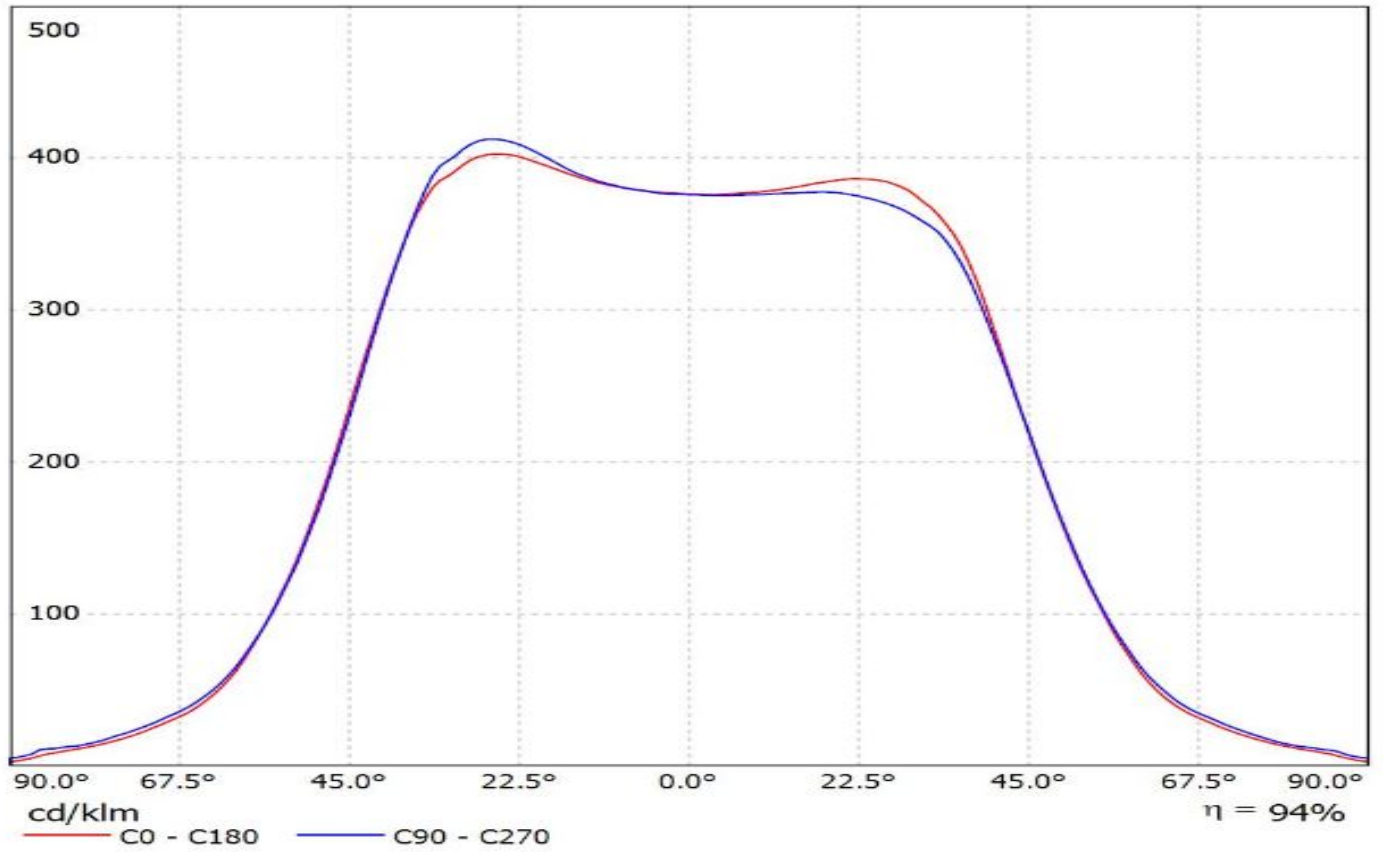

Luminaire: LEDiL Oy CS14263\_HB-IP-2X6-WWW\_(XP-G2)

Lamps: 1 x CREE\_XP-G2\_2x6\_1180.76lm@250mA\_P=8.13864W\_I=240mA

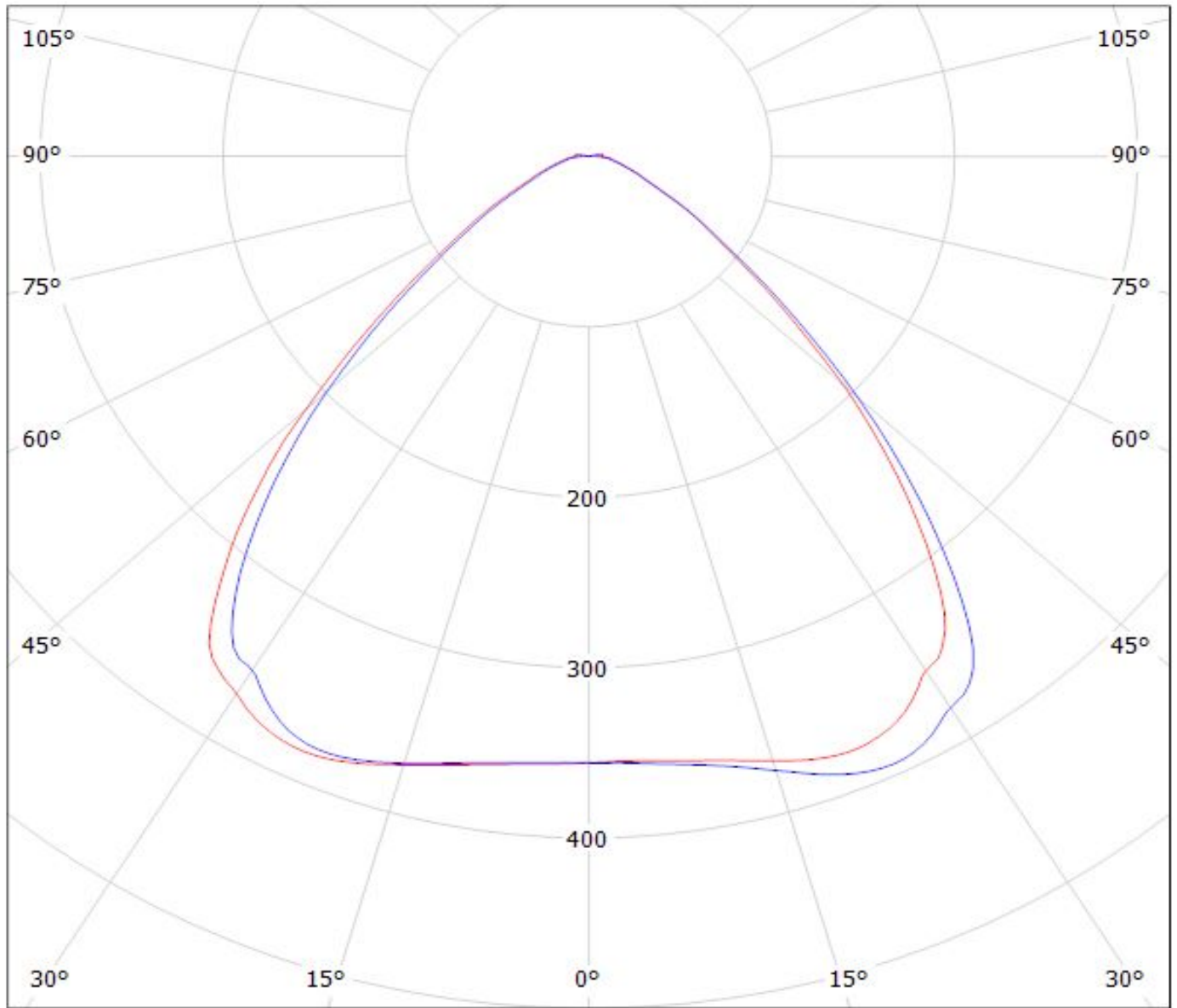

cd/klm

— C0 - C180

— C90 - C270

$\eta = 93\%$

Luminaire: LEDiL Oy CS14263\_HB-IP-2X6-WWW\_(XT-E)

Lamps: 1 x CREE\_XT-E\_6x2\_(XTEAWT-00-0000-000000HE4)\_1253.02lm@250mA\_P=8.85391W\_I=249.8mA

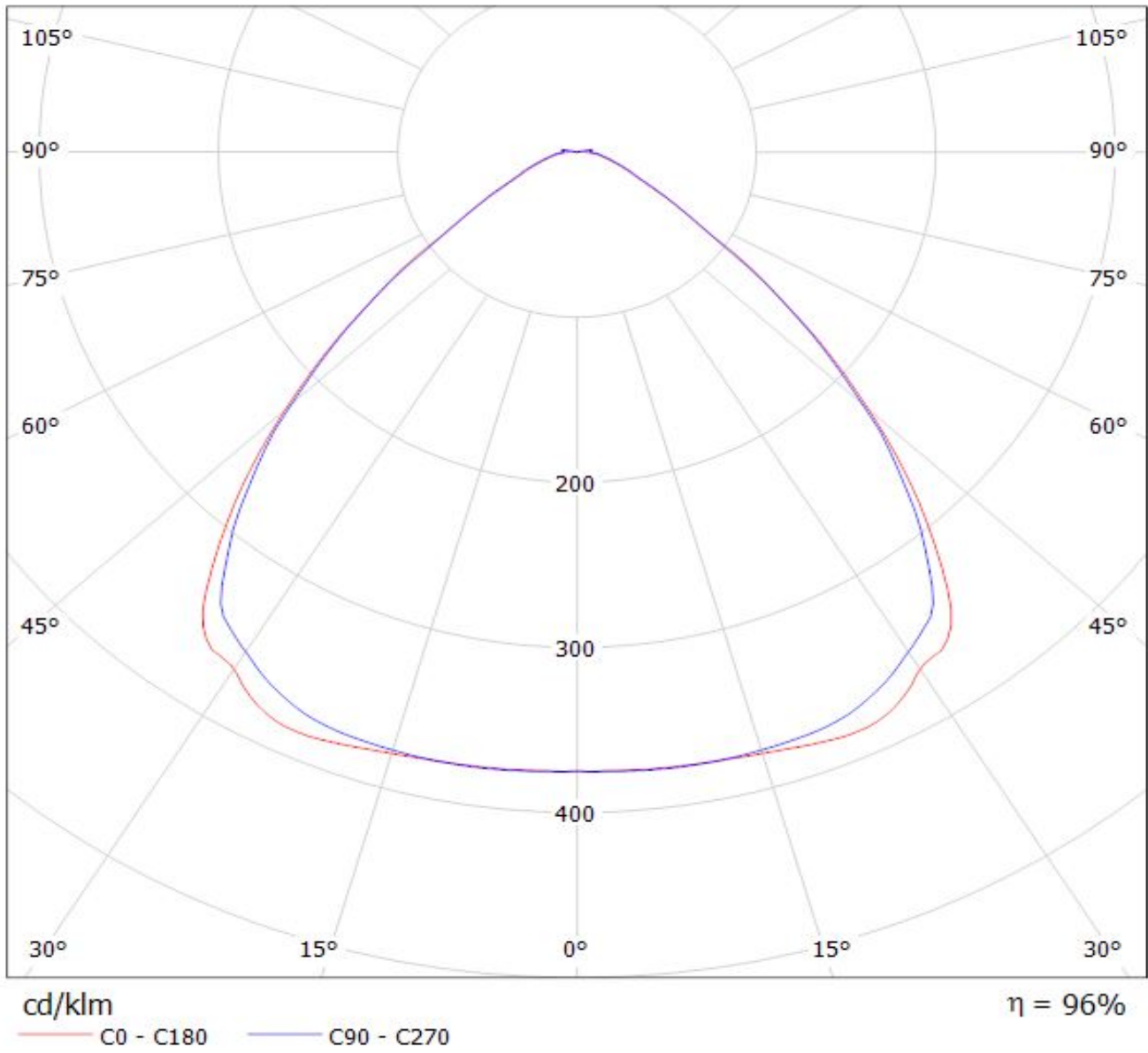

Luminaire: LEDiL Oy CS14263\_HB-IP-2X6-WWW\_(XP-L)

Lamps: 1 x CREE\_XP-L\_2x6\_(XPLAWT-0-7A3-U50-0H-0001)\_1253.88lm@250mA\_P=8.22317W\_I=249.8mA

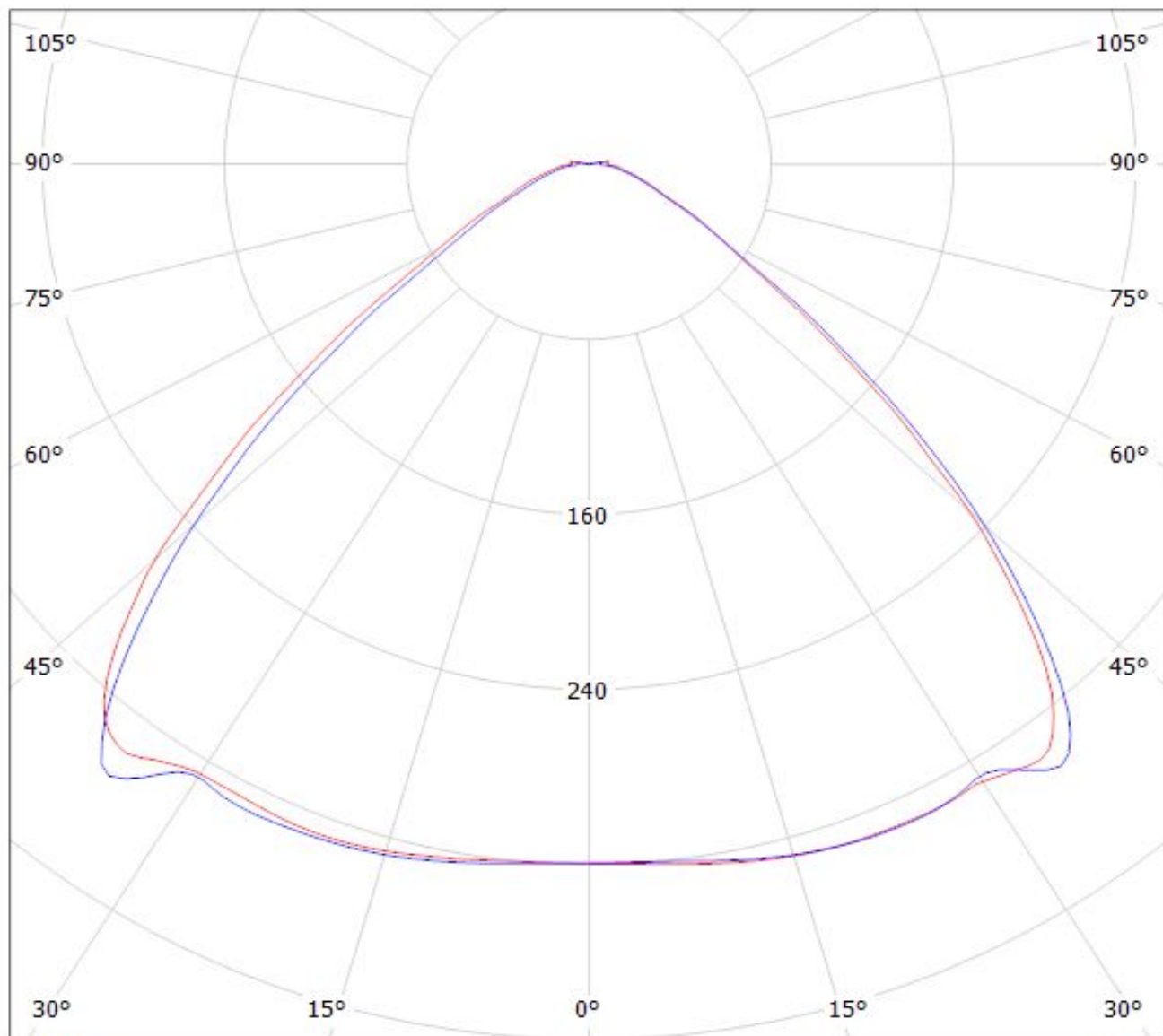

cd/klm

— C0 - C180

— C90 - C270

$\eta = 92\%$

Luminaire: LEDiL Oy CS14263\_HB-IP-2X6-WWW\_(XM-L2) Eff.92.6%  
Lamps: 1 x CREE\_XM-L2\_2x6\_1197.78lm@250mA\_P=8.38555W\_I=254.1mA

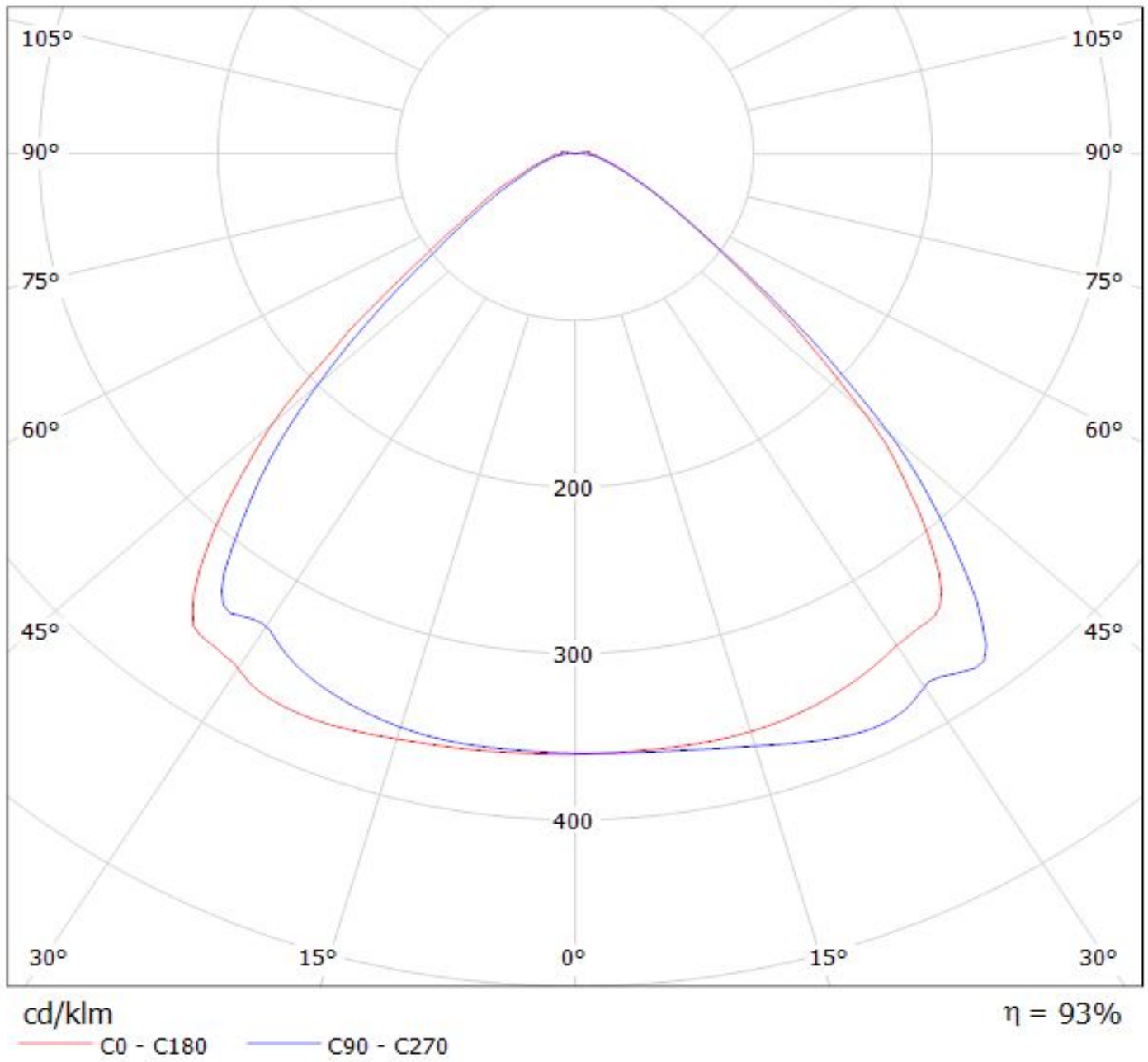



Luminaire: Ledil Oy CS14263\_HB-IP-2X6-WWW\_(XP-G3)\_SIMULATED  
Lamps: 1 x Cree XP-G3

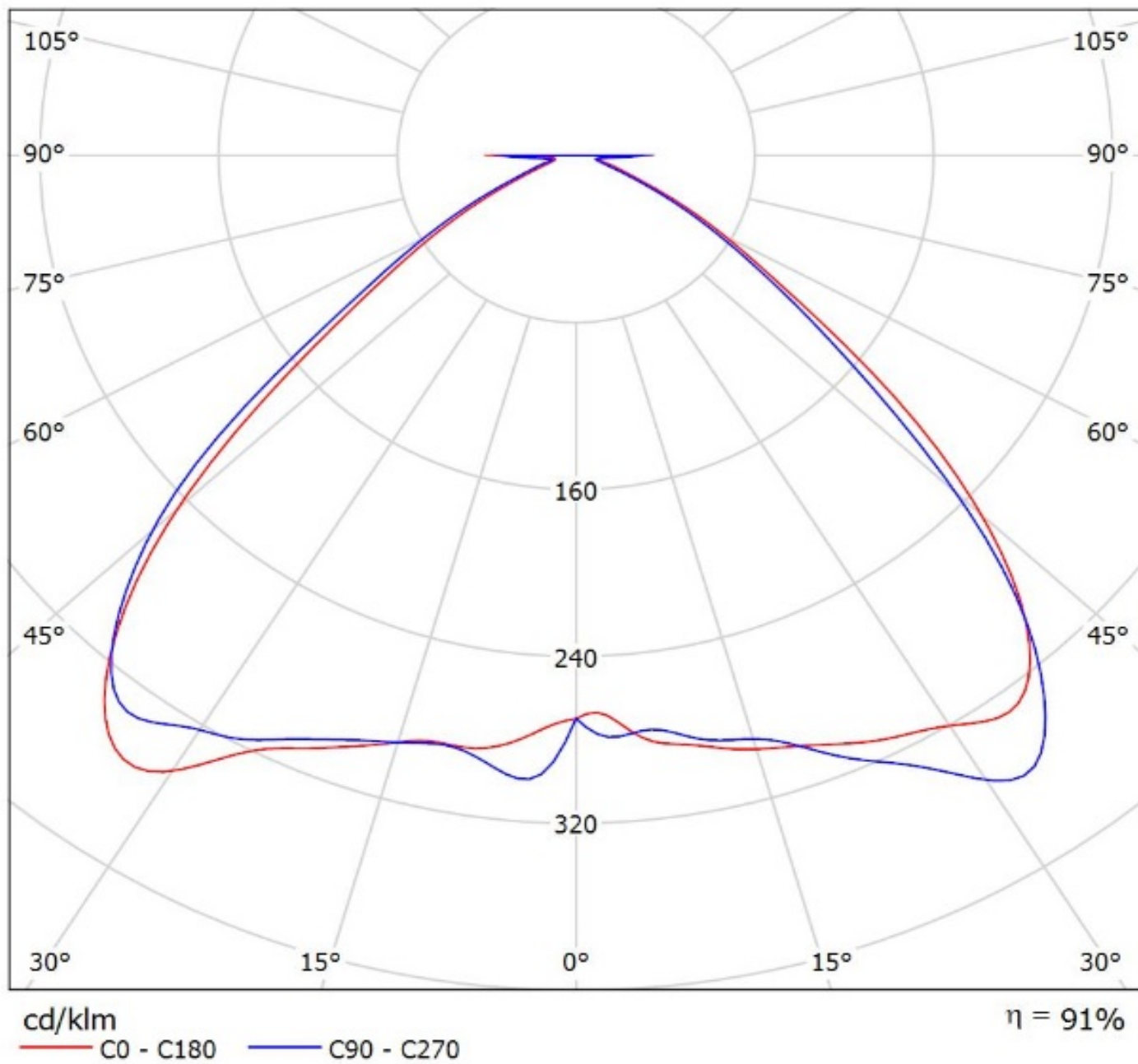

Luminaire: LEDIL CS14263\_HB-IP-2X6-WWW\_MHB\_SIMULATED

Lamps: 1 x

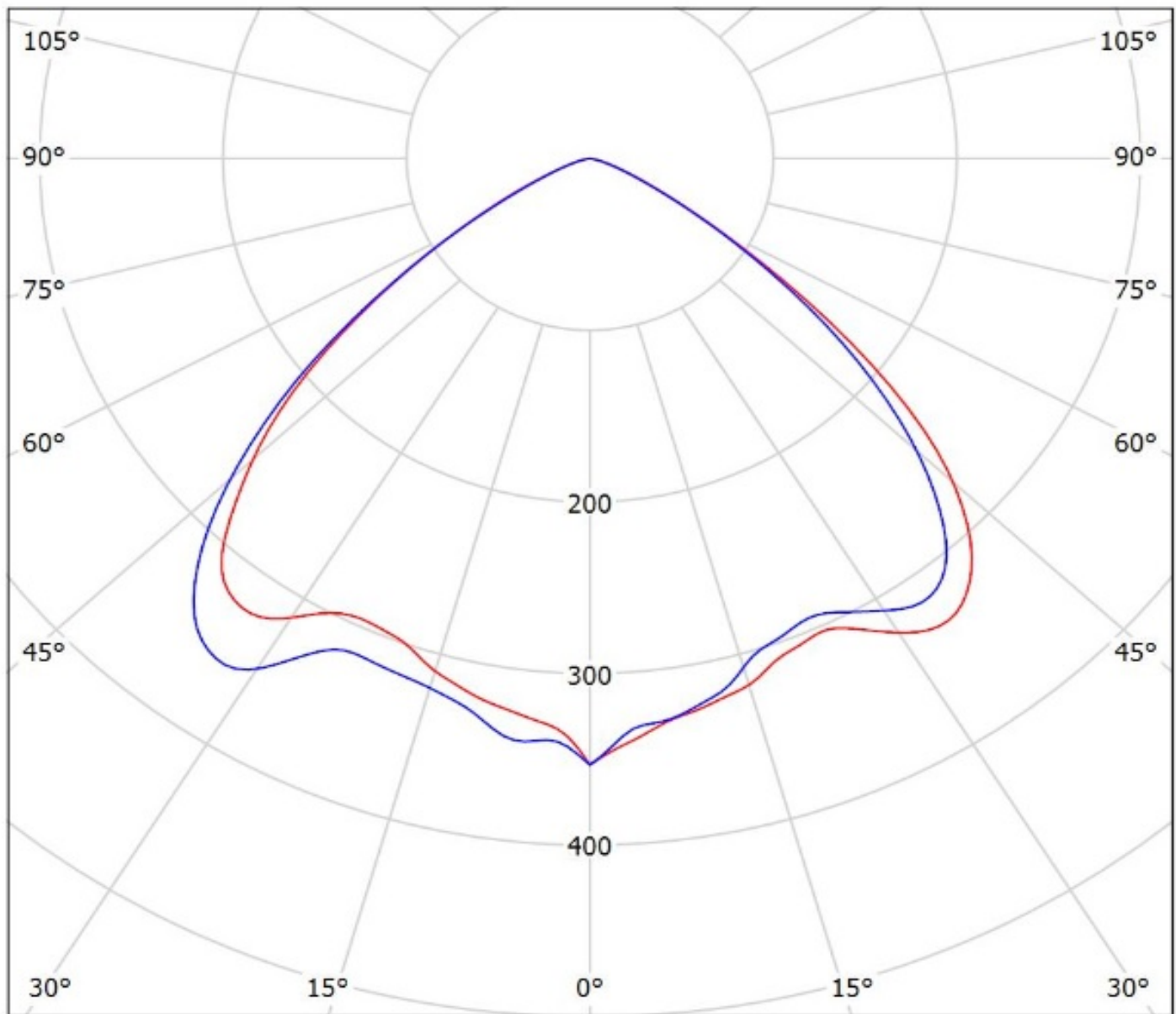

cd/klm

— C0 - C180 — C90 - C270

$\eta = 87\%$

Luminaire: Ledil CS14263\_HB-IP-2X6-WWW\_(XP-L2)

Lamps: 1 x Cree\_XP-L2\_2x6\_1659.4lm@250mA\_P=8.22525W\_I=0.25A

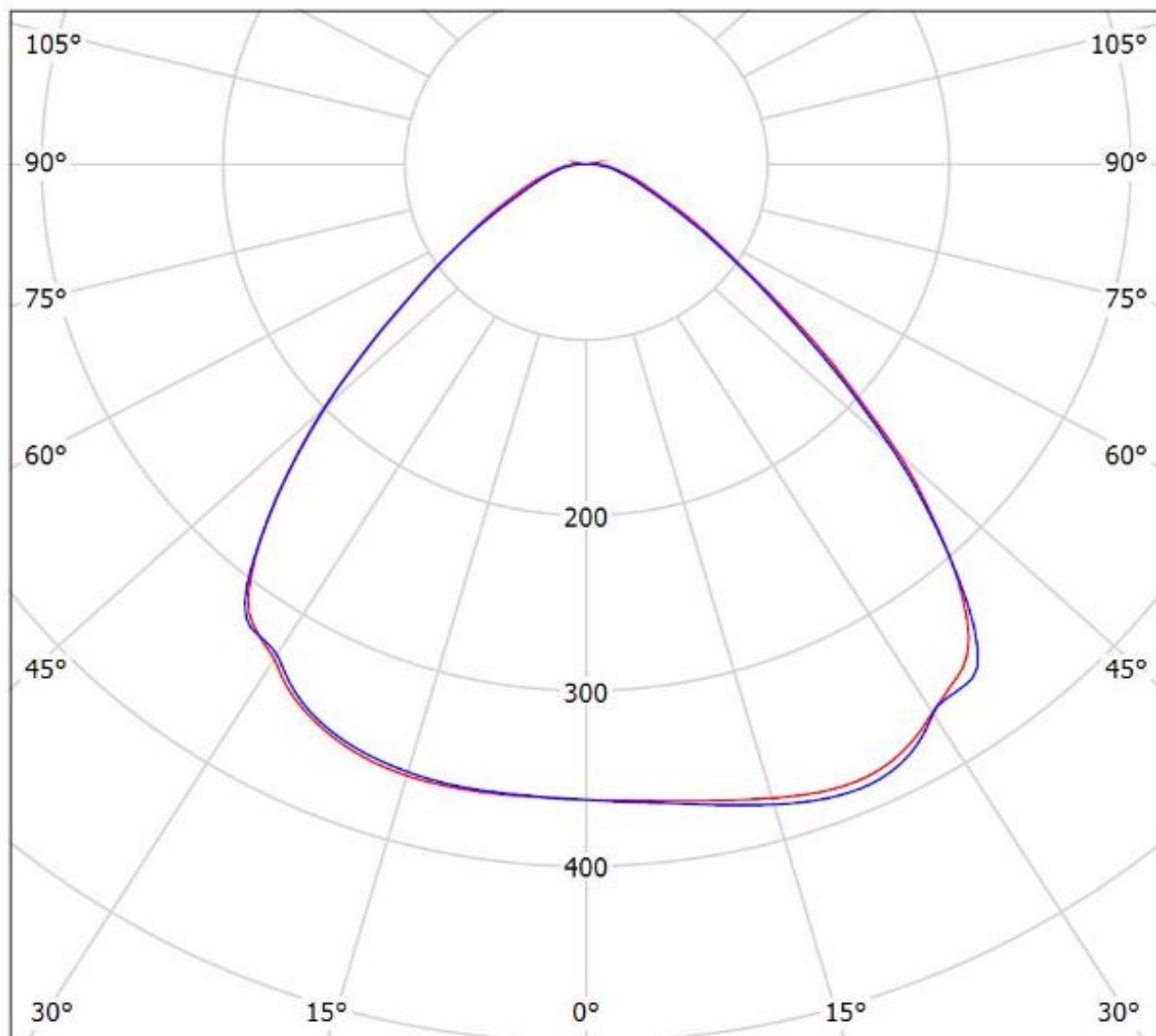

cd/klm

— C0 - C180

— C90 - C270

$\eta = 94\%$

Luminaire: Ledil Oy CS14263\_HB-IP-2X6-WWW\_(H35C1)\_SIMULATED  
Lamps: 1 x LG H35C1

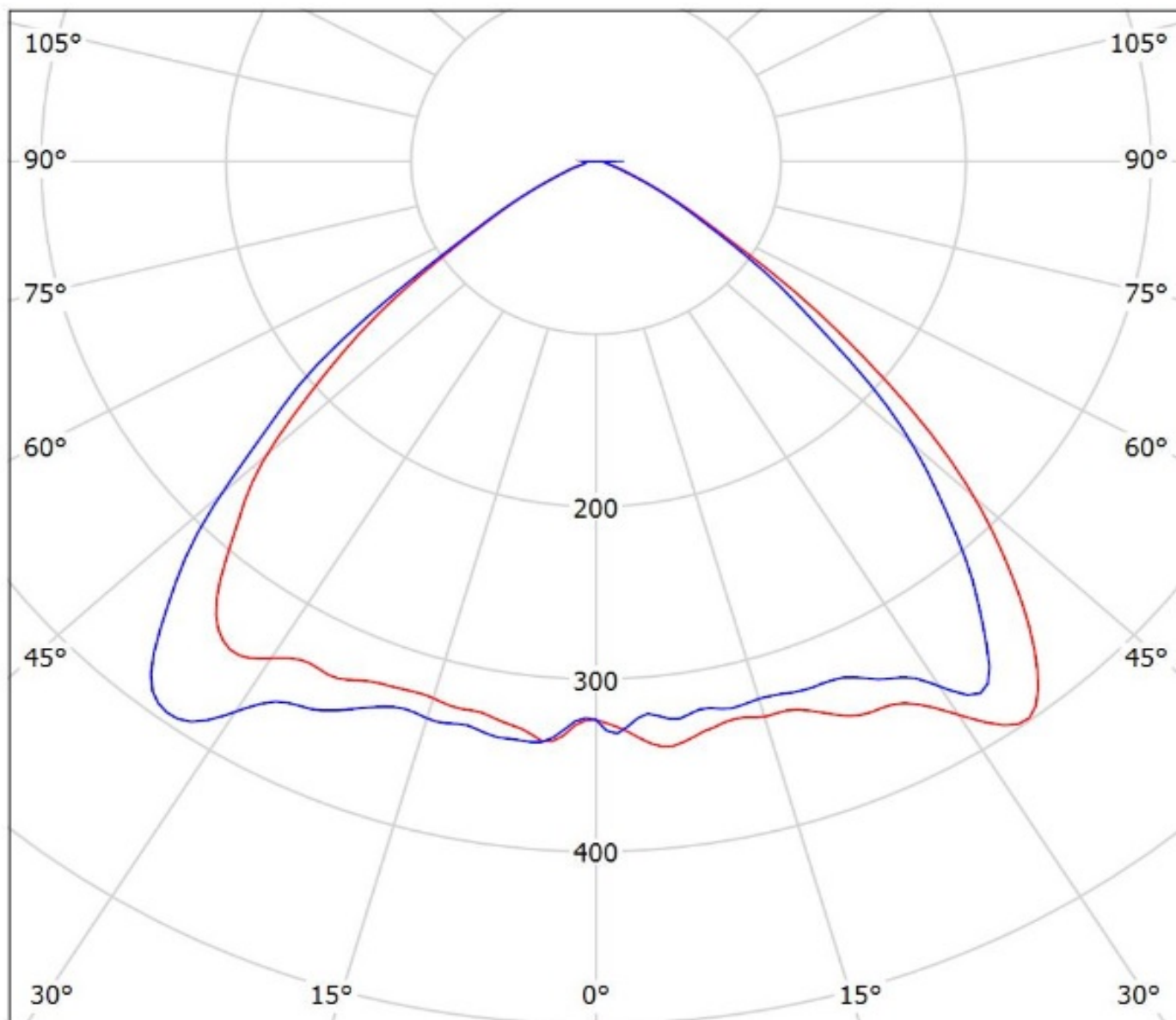

cd/klm  
— C0 - C180 — C90 - C270

$\eta = 95\%$

Luminaire: LEDiL Oy CS14263\_HB-IP-2X6-WWW\_(Luxeon\_T)

Lamps: 1 x Luxeon\_T\_2x6\_(LXH8-FW30)\_1010lm@250mA\_P=8.39003W\_I=249.8mA

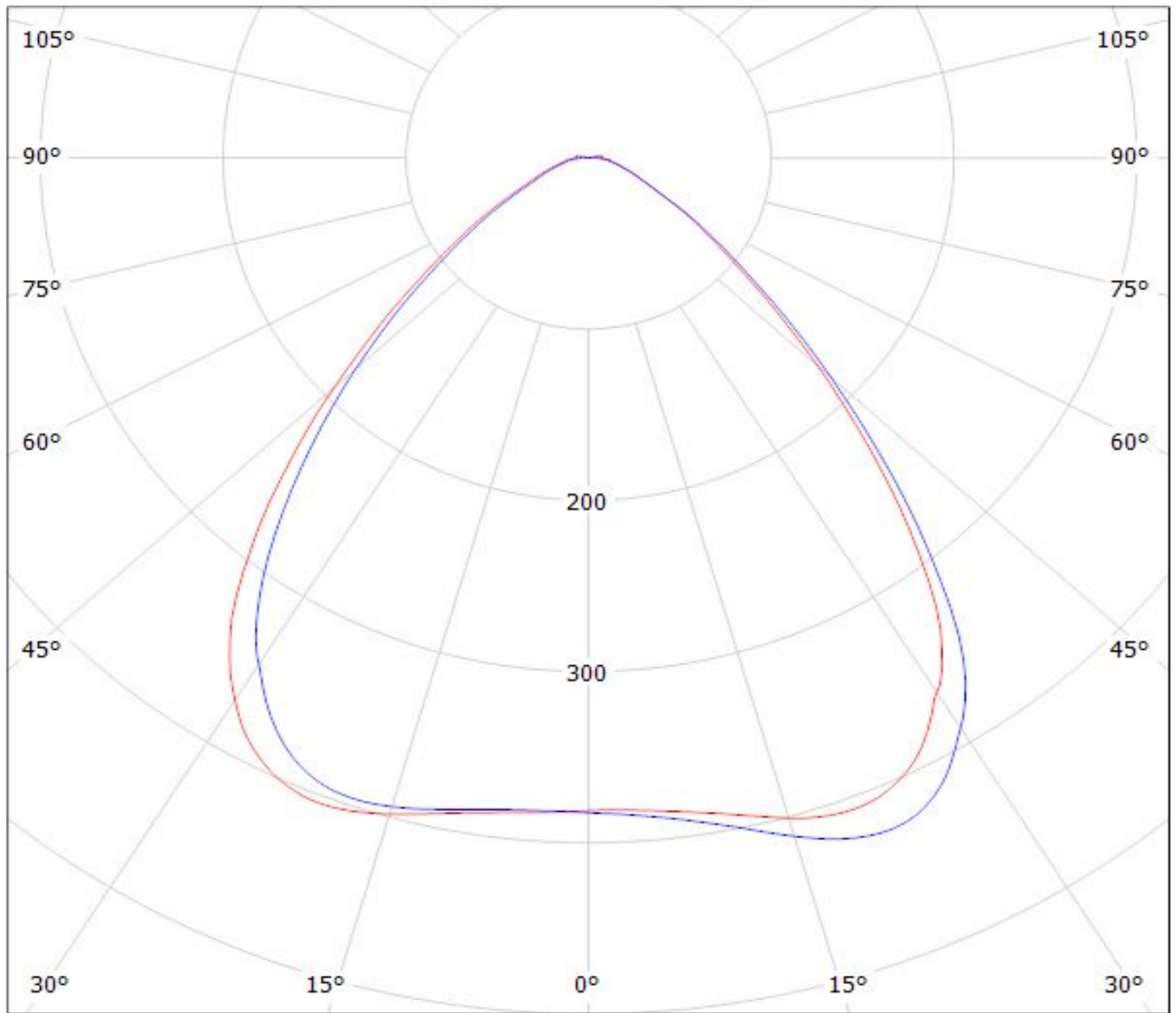

cd/klm

— C0 - C180

— C90 - C270

$\eta = 93\%$

Luminaire: LEDiL Oy CS14263\_HB-IP-2X6-WWW\_(Luxeon\_TX)  
Lamps: 1 x Luxeon\_TX\_2x6\_1286.09lm@250mA\_P=8.26138W\_I=249.8mA

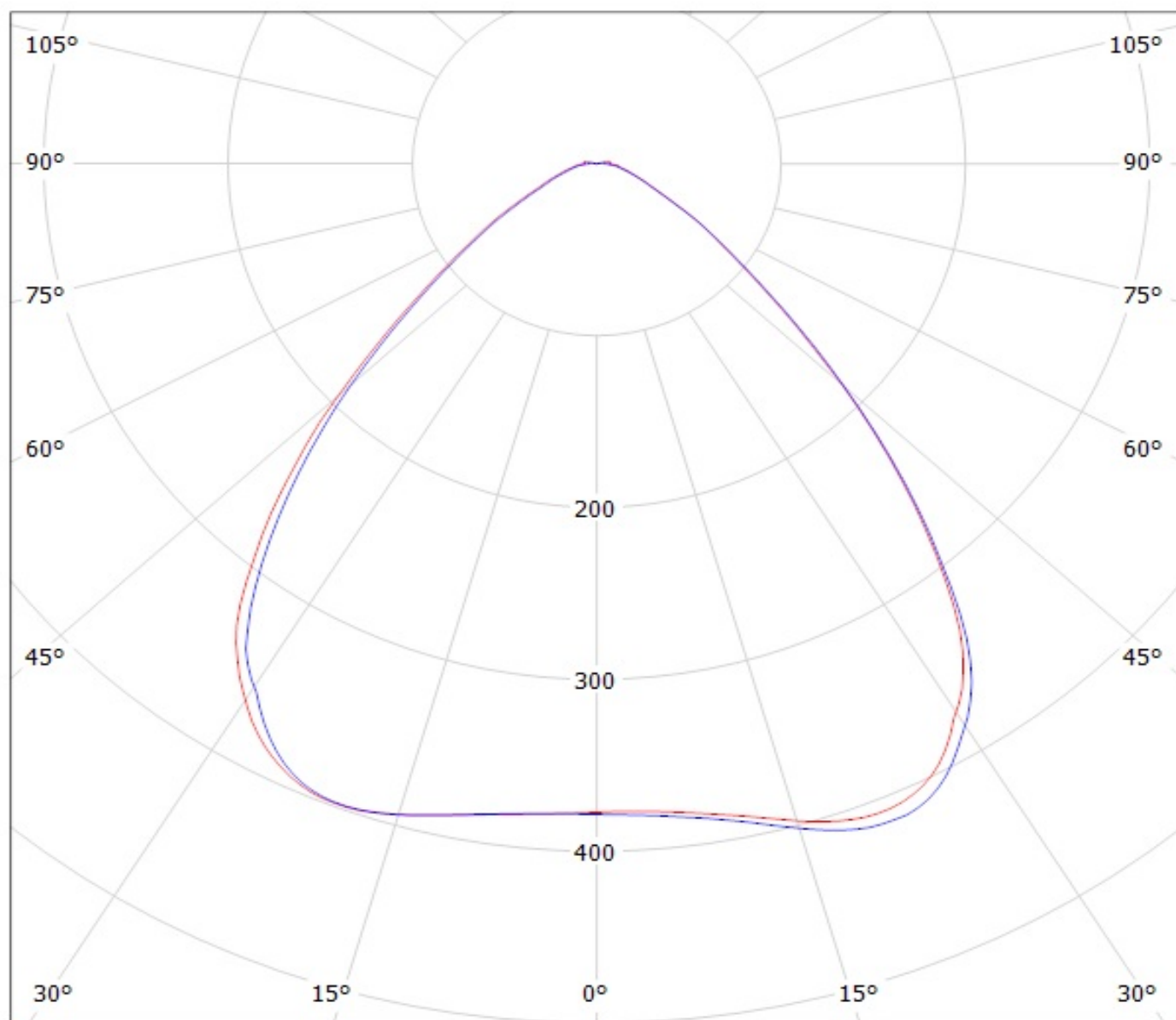

cd/klm

— C0 - C180

— C90 - C270

Luminaire: LEDiL Oy CS14263\_HB-IP-2X6-WWW\_(Luxeon\_Z\_ES)  
Lamps: 1 x LUXEON\_Z\_ES\_2x6\_967.781lm@250mA\_P=8.25189W\_I=249.8mA

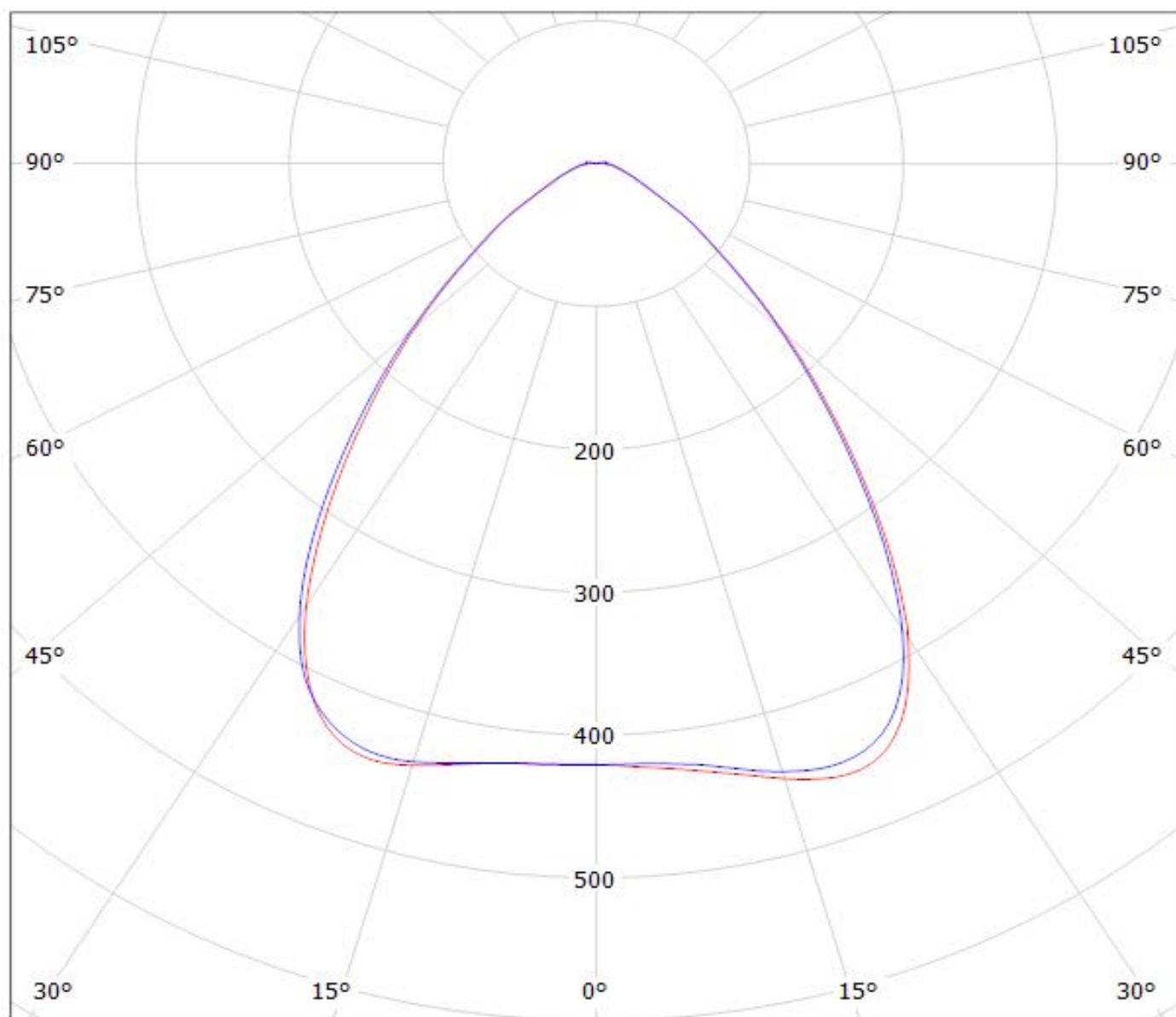

cd/klm

— C0 - C180    — C90 - C270

$\eta = 93\%$

Luminaire: Ledil CS14263\_HB-IP-2X6-WWW\_(XR-TX)  
Lamps: 1 x Luxeon\_XR-TX\_1376.41lm@250mA\_P=8.3920W\_I=0.250A

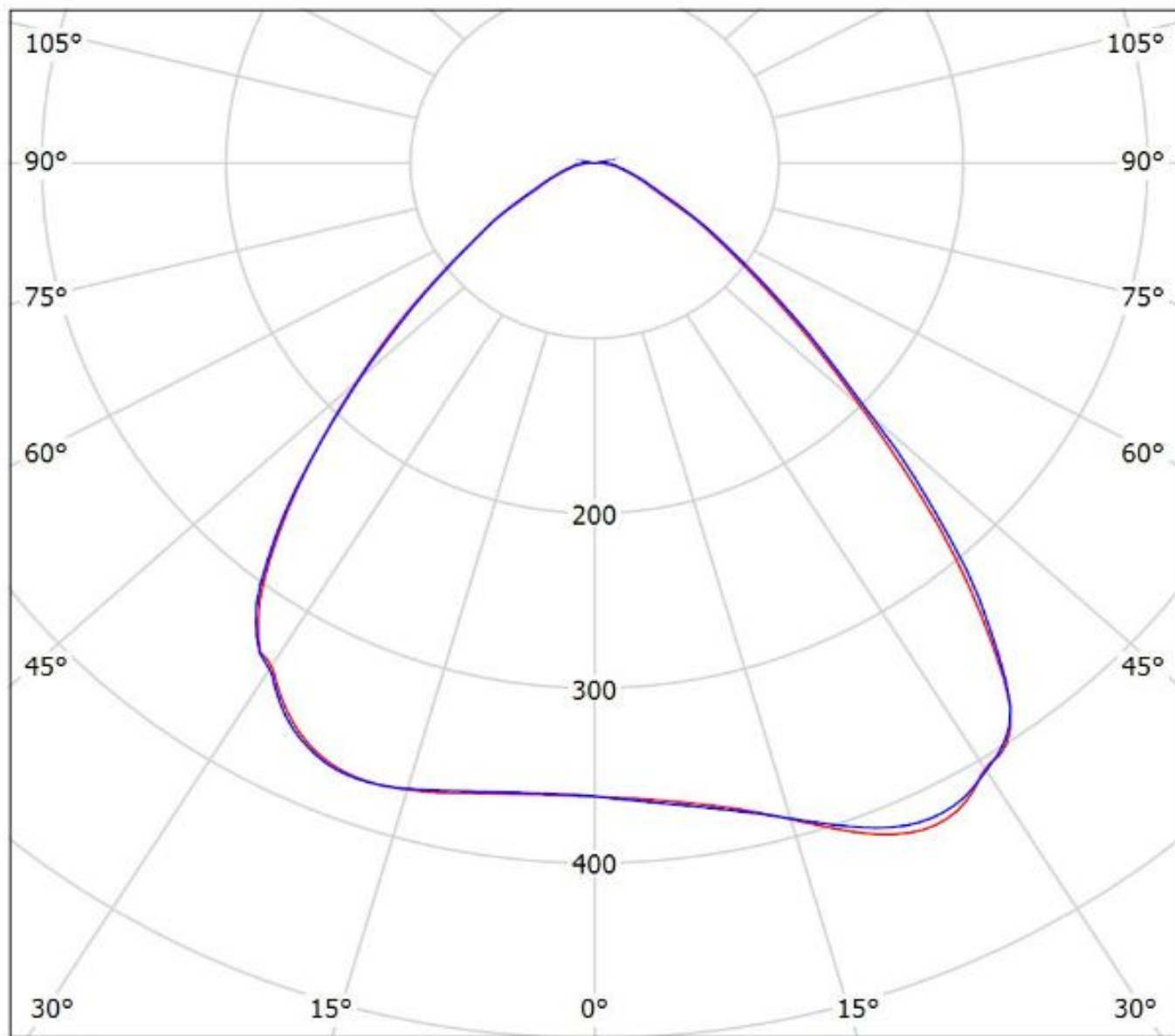

cd/klm  
— C0 - C180 — C90 - C270

$\eta = 93\%$



Luminaire: Ledil CS14263\_HB-IP-2X6-WWW\_(Nichia\_E21)

Lamps: 1 x Nichia\_NVSWE21A\_601.623lm@600mA\_P=3.5001W\_I=0.600A

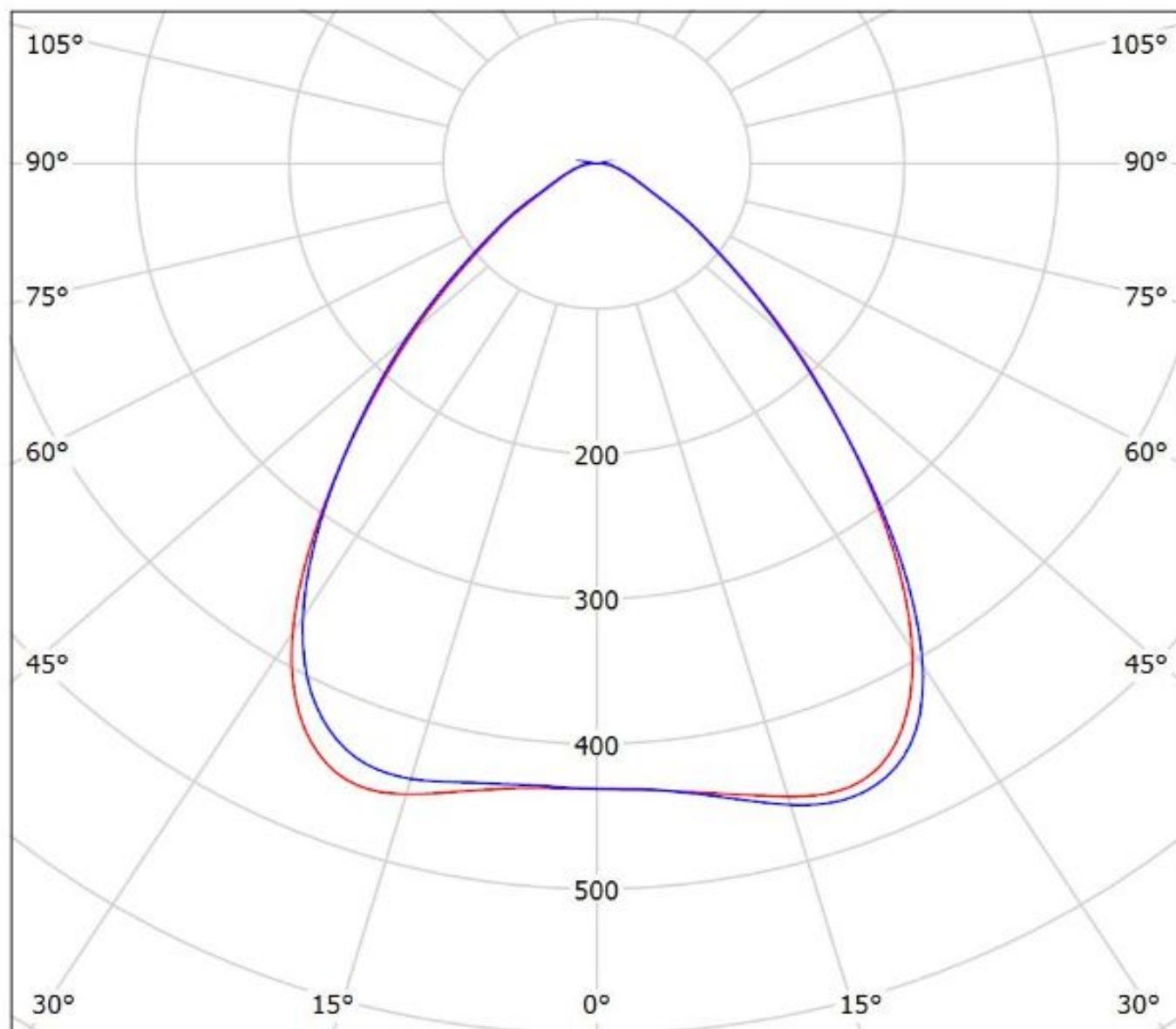

cd/klm

— C0 - C180 — C90 - C270

$\eta = 94\%$

Luminaire: LEDiL Oy CS14263\_HB-IP-2X6-WWW\_(SQ-PC)

Lamps: 1 x OSLO<sub>N</sub>\_SQUARE-PC\_1186.1lm@250mA\_P=8.73326W\_I=249.8mA

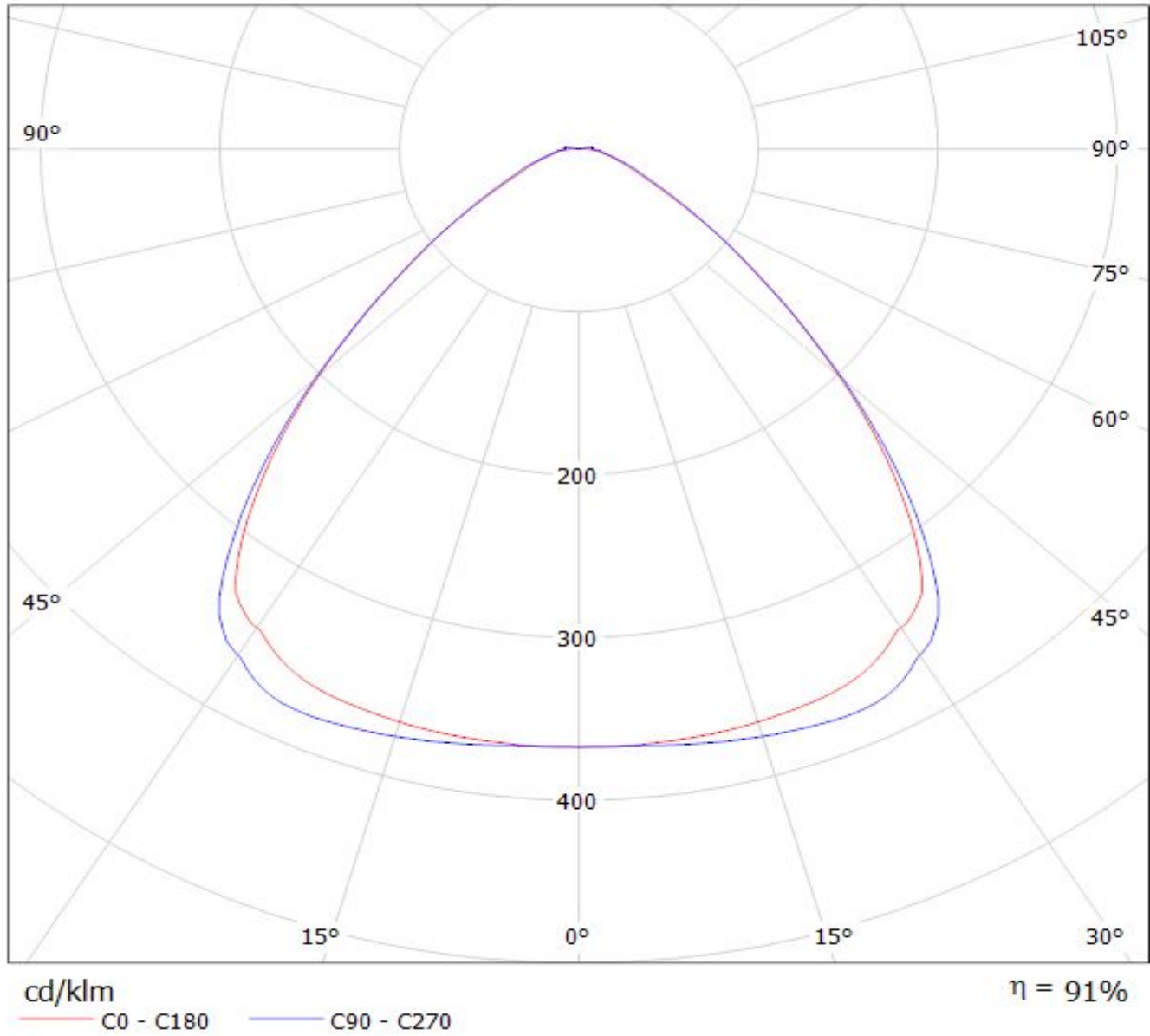

Luminaire: LEDiL Oy CS14263\_HB-IP-2X6-WWW\_(SSL80)

Lamps: 1 x SSL80\_1292.29lm@250mA\_P=8.5574W\_I=0.250A

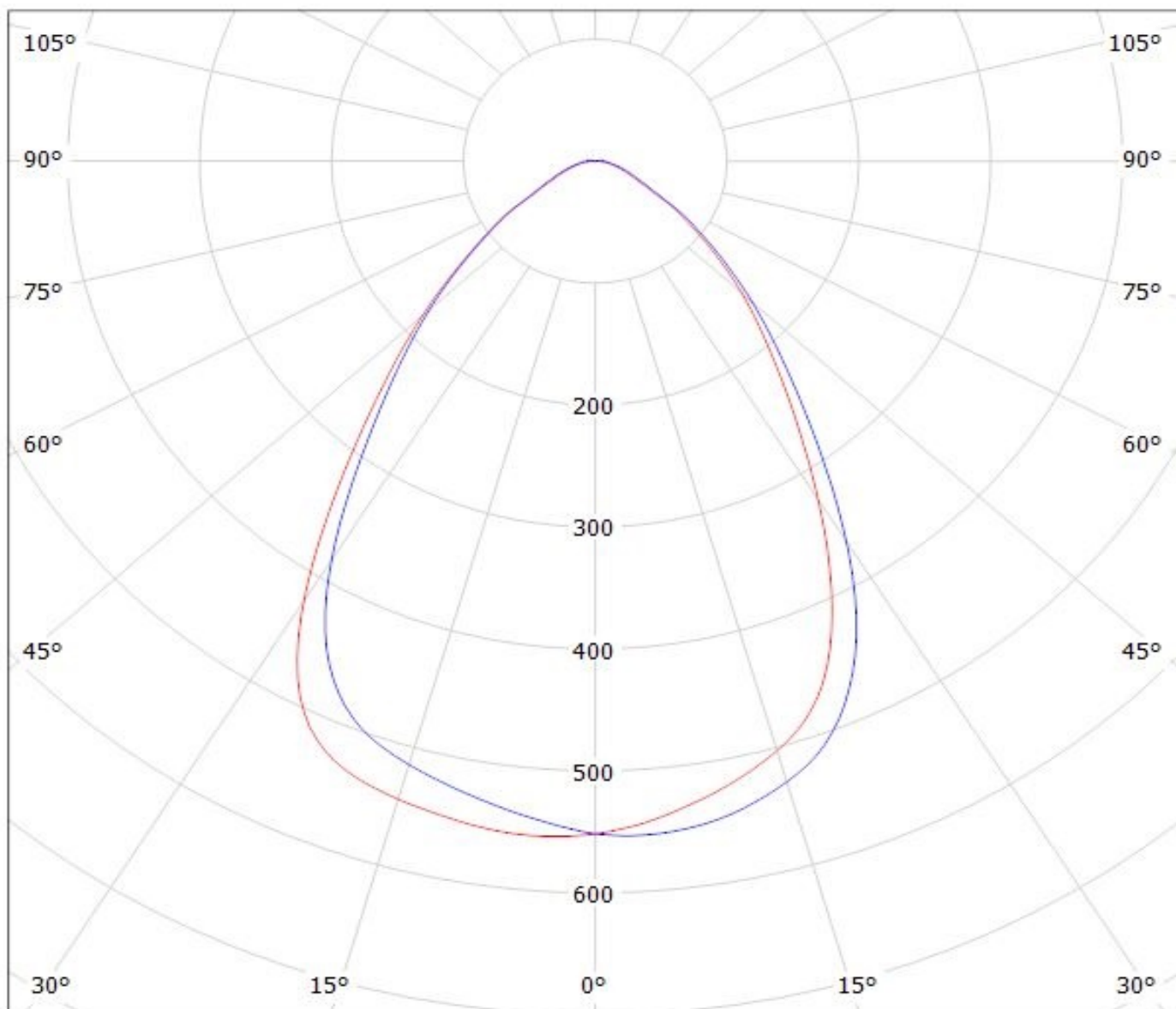

cd/klm

— C0 - C180

— C90 - C270

$\eta = 94\%$

Luminaire: Ledil Oy CS14263\_HB-IP-2X6-WWW\_OSRAM\_DURIS\_P9\_SIMULATED  
Lamps: 1 x OSRAM DURIS P9

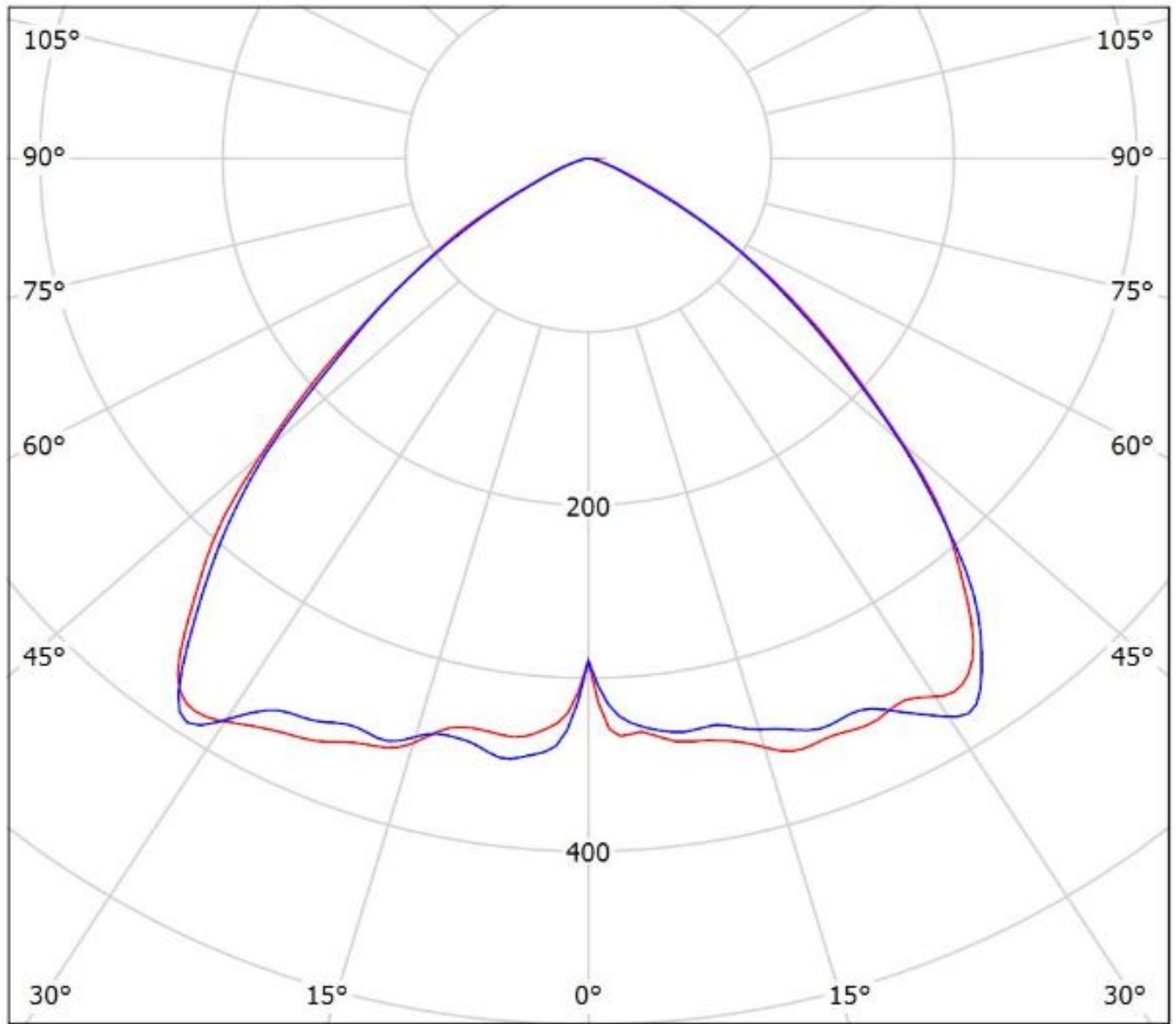

cd/klm

— C0 - C180 — C90 - C270

$\eta = 96\%$

Luminaire: Ledil CS14263\_HB-IP-2X6-WWW\_(Z5M1)\_GS

Lamps: 1 x Seoul Z5M1 (SZ5-M1-WW-C8)\_1201.44lm@250mA\_P=8.63825W\_I=0.25A

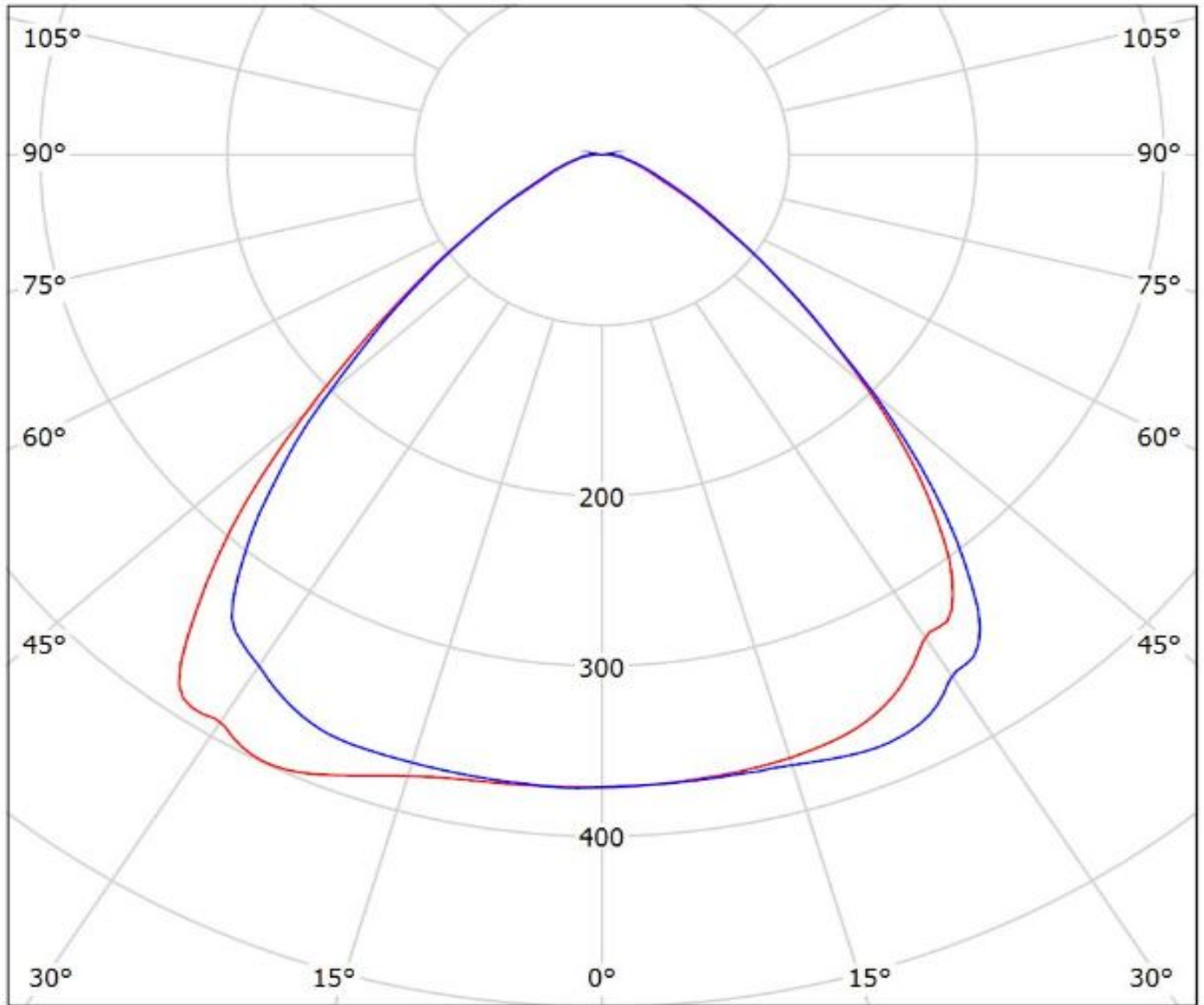

cd/klm

— C0 - C180 — C90 - C270

$\eta = 92\%$

# Ledil CS14263\_HB-IP-2X6-WWW\_(TL1L4) / LDC (Polar)

Luminaire: Ledil CS14263\_HB-IP-2X6-WWW\_(TL1L4)

Lamps: 1 x Toshiba\_TL1L4\_2x6\_(TL1L4-DW0)\_1263.19lm@250mA\_CCT=6500K\_P=8.5W\_I=0.25A

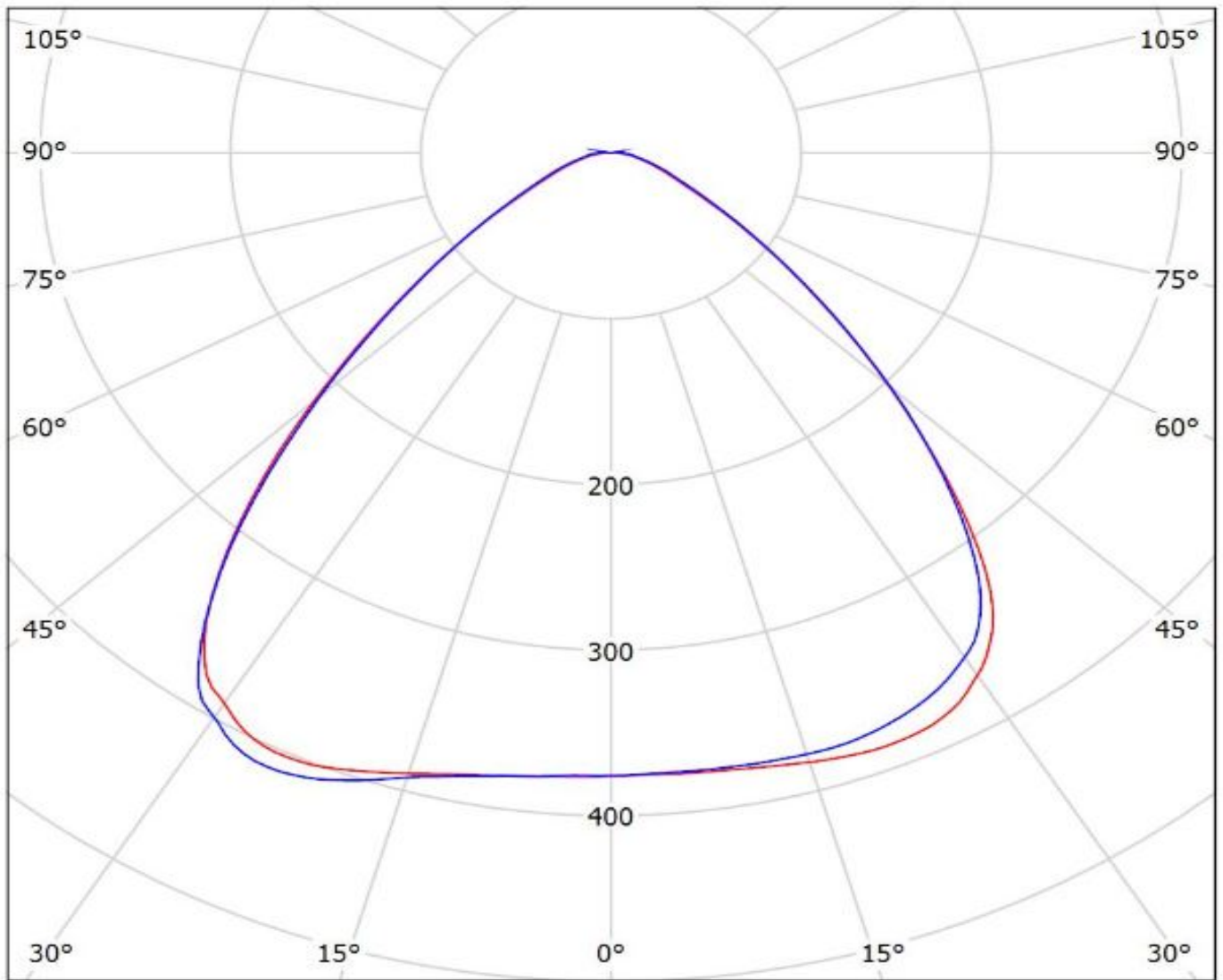

cd/klm

— C0 - C180    — C90 - C270

$\eta = 94\%$

**NOTE: The typical divergence will be changed by different color, chip size and chip position tolerance. The typical total divergence is the full angle measured where the luminous intensity is half of the peak value.**