

MC34164, MC33164, NCV33164



ON Semiconductor®

<http://onsemi.com>

Micropower Undervoltage Sensing Circuits

The MC34164 series are undervoltage sensing circuits specifically designed for use as reset controllers in portable microprocessor based systems where extended battery life is required. These devices offer the designer an economical solution for low voltage detection with a single external resistor. The MC34164 series features a bandgap reference, a comparator with precise thresholds and built-in hysteresis to prevent erratic reset operation, an open collector reset output capable of sinking in excess of 6.0 mA, and guaranteed operation down to 1.0 V input with extremely low standby current. The MC devices are packaged in 3-pin TO-226AA, micro size TSOP-5, 8-pin SOIC-8 and Micro8™ surface mount packages. The NCV device is packaged in SOIC-8.

Applications include direct monitoring of the 3.0 V or 5.0 V MPU/logic power supply used in appliance, automotive, consumer, and industrial equipment.

- Temperature Compensated Reference
- Monitors 3.0 V (MC34164-3) or 5.0 V (MC34164-5) Power Supplies
- Precise Comparator Thresholds Guaranteed Over Temperature
- Comparator Hysteresis Prevents Erratic Reset
- Reset Output Capable of Sinking in Excess of 6.0 mA
- Internal Clamp Diode for Discharging Delay Capacitor
- Guaranteed Reset Operation With 1.0 V Input
- Extremely Low Standby Current: As Low as 9.0 μ A
- Economical TO-226AA, TSOP-5, SOIC-8 and Micro8 Surface Mount Packages
- NCV Prefix for Automotive and Other Applications Requiring Site and Control Changes
- Pb-Free Packages are Available

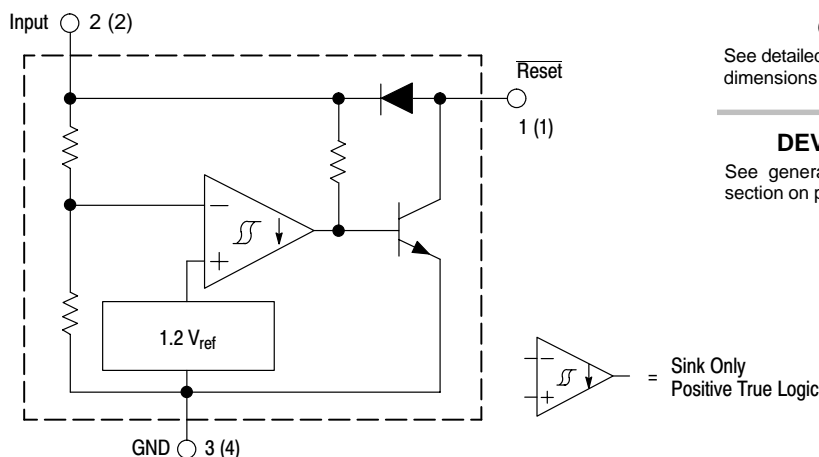
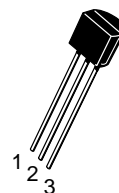

Figure 1. Representative Block Diagram

Pin numbers adjacent to terminals are for the 3-pin TO-226AA package.
Pin numbers in parenthesis are for the 8-lead packages.
This device contains 28 active transistors.



TO-226AA
P SUFFIX
CASE 29



SOIC-8
D SUFFIX
CASE 751



Micro8
DM SUFFIX
CASE 846A

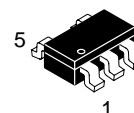

TSOP-5
SN SUFFIX
CASE 483

PIN CONNECTIONS

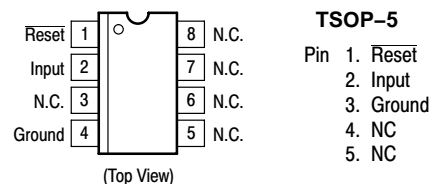

ORDERING INFORMATION

See detailed ordering and shipping information in the package dimensions section on page 7 of this data sheet.

DEVICE MARKING INFORMATION

See general marking information in the device marking section on page 8 of this data sheet.

MC34164, MC33164, NCV33164

MAXIMUM RATINGS

Rating	Symbol	Value	Unit
Power Input Supply Voltage	V_{in}	-1.0 to 12	V
Reset Output Voltage	V_O	-1.0 to 12	V
Reset Output Sink Current	I_{Sink}	Internally Limited	mA
Clamp Diode Forward Current, Pin 1 to 2 (Note 1)	I_F	100	mA
Power Dissipation and Thermal Characteristics			
P Suffix, Plastic Package			
Maximum Power Dissipation @ $T_A = 25^\circ\text{C}$	P_D	700	mW
Thermal Resistance, Junction-to-Air	$R_{\theta JA}$	178	$^\circ\text{C/W}$
D Suffix, Plastic Package			
Maximum Power Dissipation @ $T_A = 25^\circ\text{C}$	P_D	700	mW
Thermal Resistance, Junction-to-Air	$R_{\theta JA}$	178	$^\circ\text{C/W}$
DM Suffix, Plastic Package			
Maximum Power Dissipation @ $T_A = 25^\circ\text{C}$	P_D	520	mW
Thermal Resistance, Junction-to-Air	$R_{\theta JA}$	240	$^\circ\text{C/W}$
Operating Junction Temperature	T_J	+150	$^\circ\text{C}$
Operating Ambient Temperature Range	T_A		$^\circ\text{C}$
MC34164 Series		0 to +70	
MC33164 Series, NCV33164		-40 to +125	
Storage Temperature Range	T_{stg}	-65 to +150	$^\circ\text{C}$
Electrostatic Discharge Sensitivity (ESD)	ESD		V
Human Body Model (HBM)		4000	
Machine Model (MM)		200	

Maximum ratings are those values beyond which device damage can occur. Maximum ratings applied to the device are individual stress limit values (not normal operating conditions) and are not valid simultaneously. If these limits are exceeded, device functional operation is not implied, damage may occur and reliability may be affected.

MC34164-3, MC33164-3 SERIES, NCV33164-3

ELECTRICAL CHARACTERISTICS (For typical values $T_A = 25^\circ\text{C}$, for min/max values T_A is the operating ambient temperature range that applies [Notes 2 & 3], unless otherwise noted.)

Characteristic	Symbol	Min	Typ	Max	Unit
----------------	--------	-----	-----	-----	------

COMPARATOR

Threshold Voltage					V
High State Output (V_{in} Increasing)	V_{IH}	2.55	2.71	2.80	
Low State Output (V_{in} Decreasing)	V_{IL}	2.55	2.65	2.80	
Hysteresis ($I_{Sink} = 100 \mu\text{A}$)	V_H	0.03	0.06	-	

RESET OUTPUT

Output Sink Saturation	V_{OL}				V
($V_{in} = 2.4 \text{ V}$, $I_{Sink} = 1.0 \text{ mA}$)		-	0.14	0.4	
($V_{in} = 1.0 \text{ V}$, $I_{Sink} = 0.25 \text{ mA}$)		-	0.1	0.3	
Output Sink Current (V_{in} , $\overline{\text{Reset}} = 2.4 \text{ V}$)	I_{Sink}	6.0	12	30	mA
Output Off-State Leakage	$I_R(\text{leak})$				μA
(V_{in} , $\overline{\text{Reset}} = 3.0 \text{ V}$)		-	0.02	0.5	
(V_{in} , $\overline{\text{Reset}} = 10 \text{ V}$)		-	0.02	1.0	
Clamp Diode Forward Voltage, Pin 1 to 2 ($I_F = 5.0 \text{ mA}$)	V_F	0.6	0.9	1.2	V

TOTAL DEVICE

Operating Input Voltage Range	V_{in}	1.0 to 10	-	-	V
Quiescent Input Current	I_{in}				μA
$V_{in} = 3.0 \text{ V}$		-	9.0	15	
$V_{in} = 6.0 \text{ V}$		-	24	40	

- Maximum package power dissipation limits must be observed.
- Low duty cycle pulse techniques are used during test to maintain junction temperature as close to ambient as possible.
- $T_{low} = 0^\circ\text{C}$ for MC34164 $T_{high} = +70^\circ\text{C}$ for MC34164
 = -40°C for MC33164, NCV33164 = $+125^\circ\text{C}$ for MC33164, NCV33164

MC34164, MC33164, NCV33164

MC34164-5, MC33164-5 SERIES, NCV33164-5

ELECTRICAL CHARACTERISTICS (For typical values $T_A = 25^\circ\text{C}$, for min/max values T_A is the operating ambient temperature range that applies [Notes 5 & 6], unless otherwise noted.)

Characteristic	Symbol	Min	Typ	Max	Unit
----------------	--------	-----	-----	-----	------

COMPARATOR

Threshold Voltage					V
High State Output (V_{in} Increasing)	V_{IH}	4.15	4.33	4.45	
Low State Output (V_{in} Decreasing)	V_{IL}	4.15	4.27	4.45	
Hysteresis ($I_{Sink} = 100 \mu\text{A}$)	V_H	0.02	0.09	-	

RESET OUTPUT

Output Sink Saturation ($V_{in} = 4.0 \text{ V}$, $I_{Sink} = 1.0 \text{ mA}$) ($V_{in} = 1.0 \text{ V}$, $I_{Sink} = 0.25 \text{ mA}$)	V_{OL}	-	0.14 0.1	0.4 0.3	V
Output Sink Current (V_{in} , $\overline{\text{Reset}} = 4.0 \text{ V}$)	I_{Sink}	7.0	20	50	mA
Output Off-State Leakage (V_{in} , $\overline{\text{Reset}} = 5.0 \text{ V}$) (V_{in} , $\overline{\text{Reset}} = 10 \text{ V}$)	$I_R(\text{leak})$	-	0.02 0.02	0.5 2.0	μA
Clamp Diode Forward Voltage, Pin 1 to 2 ($I_F = 5.0 \text{ mA}$)	V_F	0.6	0.9	1.2	V

TOTAL DEVICE

Operating Input Voltage Range	V_{in}	1.0 to 10	-	-	V
Quiescent Input Current $V_{in} = 5.0 \text{ V}$ $V_{in} = 10 \text{ V}$	I_{in}	-	12 32	20 50	μA

- Maximum package power dissipation limits must be observed.
- Low duty cycle pulse techniques are used during test to maintain junction temperature as close to ambient as possible.
- $T_{low} = 0^\circ\text{C}$ for MC34164 $T_{high} = +70^\circ\text{C}$ for MC34164
 $= -40^\circ\text{C}$ for MC33164, NCV33164 $= +125^\circ\text{C}$ for MC33164, NCV33164
- NCV prefix is for automotive and other applications requiring site and change control.

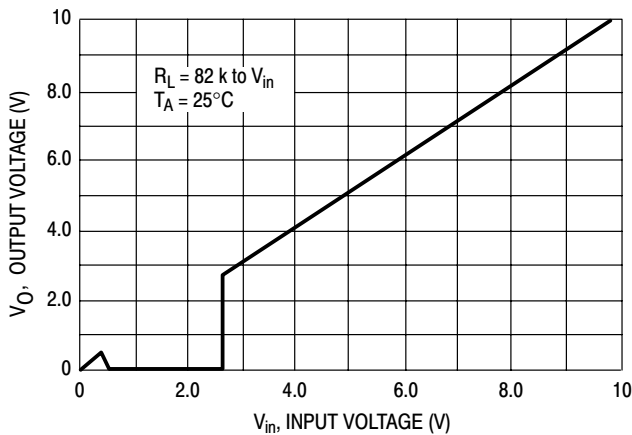

Figure 2. MC3X164-3 $\overline{\text{Reset}}$ Output Voltage versus Input Voltage

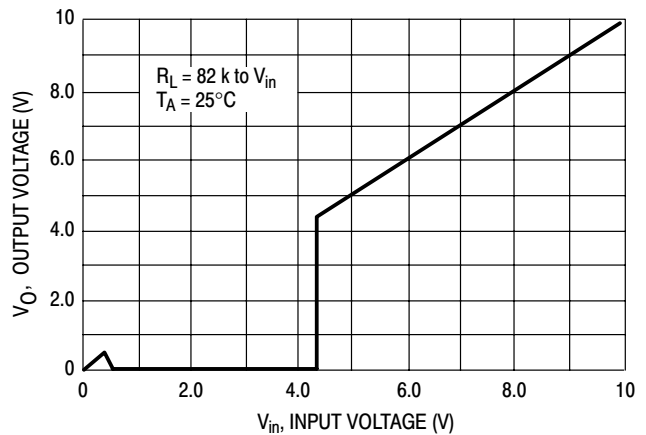

Figure 3. MC3X164-5 $\overline{\text{Reset}}$ Output Voltage versus Input Voltage

MC34164, MC33164, NCV33164

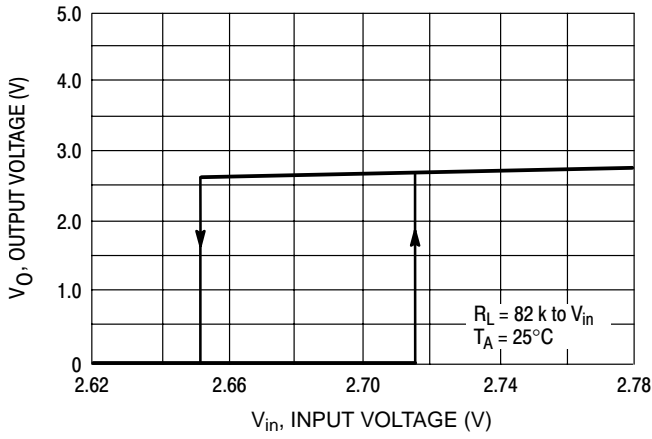

Figure 4. MC3X164-3 $\overline{\text{Reset}}$ Output Voltage versus Input Voltage

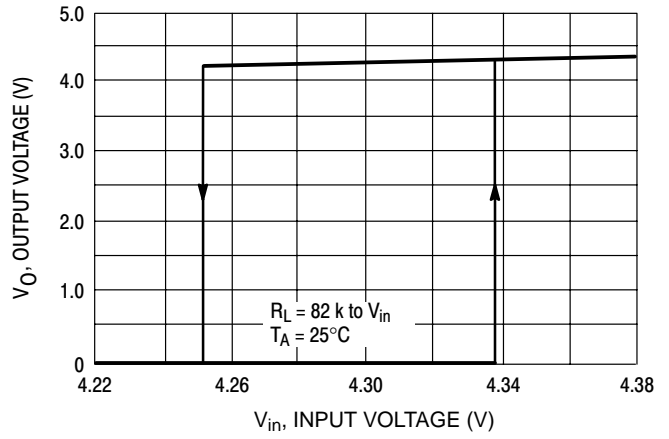

Figure 5. MC3X164-5 $\overline{\text{Reset}}$ Output Voltage versus Input Voltage

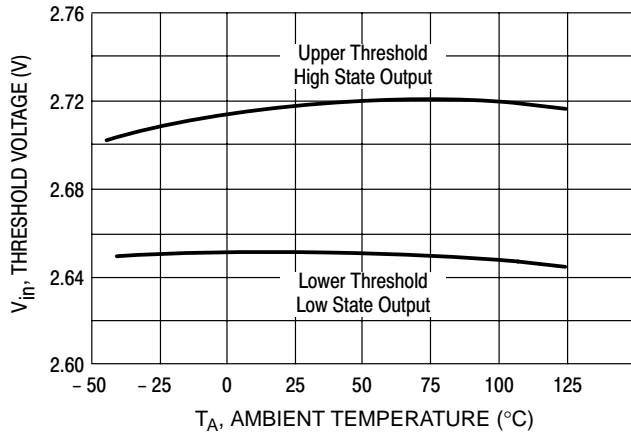

Figure 6. MC3X164-3 Comparator Threshold Voltage versus Temperature

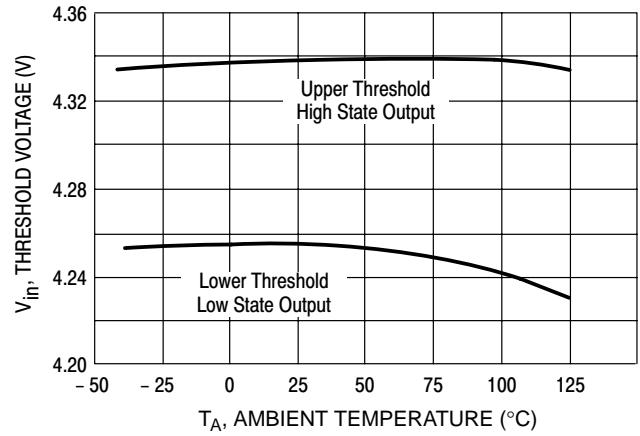

Figure 7. MC3X164-5 Comparator Threshold Voltage versus Temperature

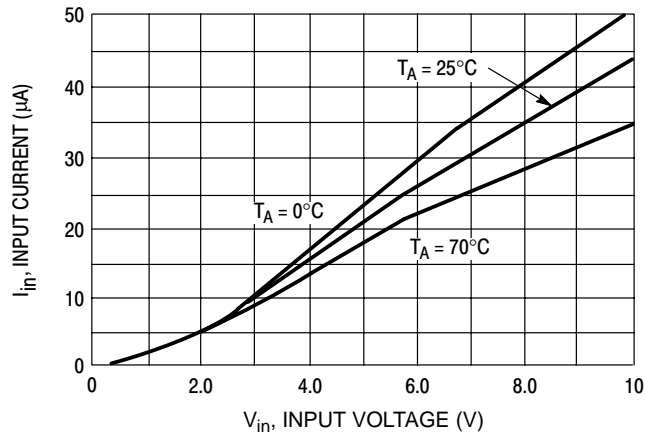

Figure 8. MC3X164-3 Input Current versus Input Voltage

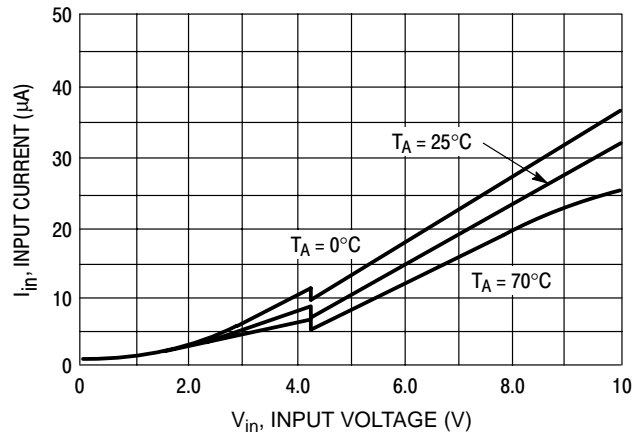

Figure 9. MC3X164-5 Input Current versus Input Voltage

MC34164, MC33164, NCV33164

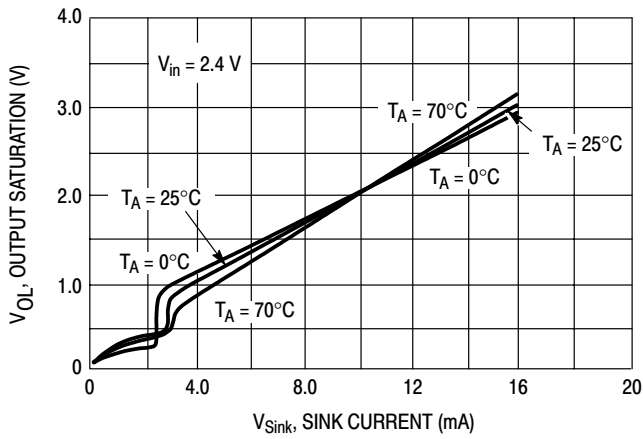

Figure 10. MC3X164-3 $\overline{\text{Reset}}$ Output Saturation versus Sink Current

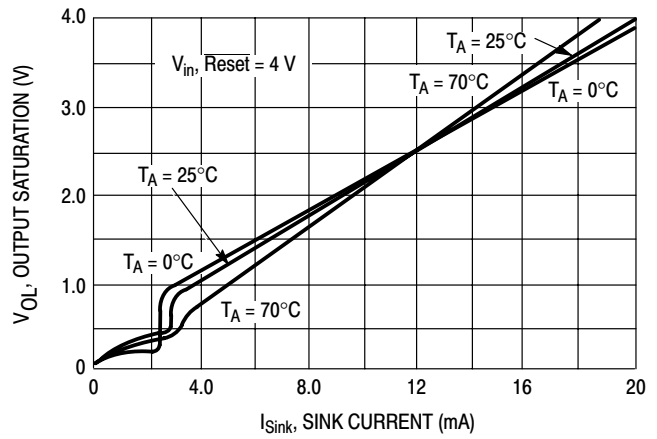

Figure 11. MC3X164-5 $\overline{\text{Reset}}$ Output Saturation versus Sink Current

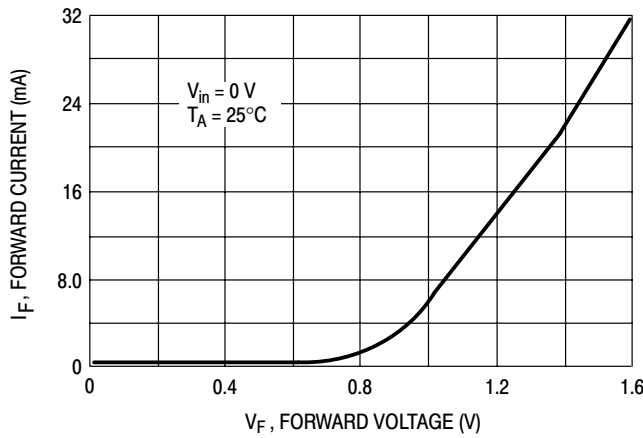

Figure 12. Clamp Diode Forward Current versus Voltage

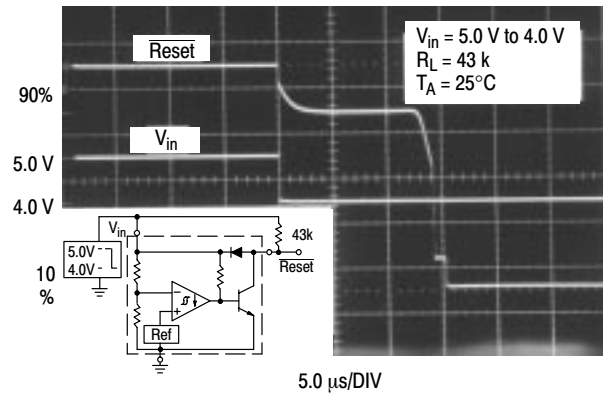
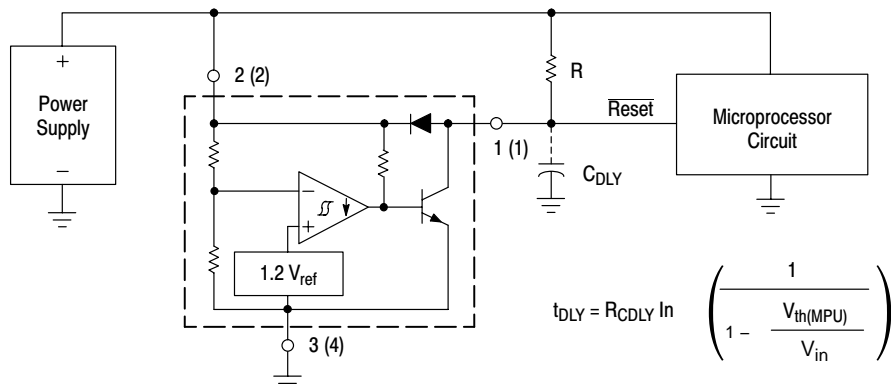

Figure 13. $\overline{\text{Reset}}$ Delay Time (MC3X164-5 Shown)



A time delayed reset can be accomplished with the addition of C_{DLY} . For systems with extremely fast power supply rise times (< 500 ns) it is recommended that the $R C_{DLY}$ time constant be greater than 5.0 μ s. $V_{th(MPU)}$ is the microprocessor reset input threshold.

Figure 14. Low Voltage Microprocessor Reset

MC34164, MC33164, NCV33164

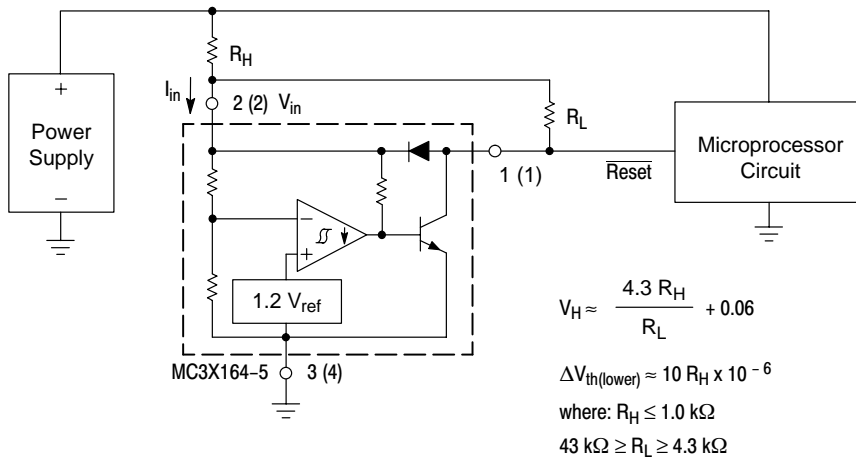

Test Data			
V _H (mV)	ΔV _{th} (mV)	R _H (Ω)	R _L (kΩ)
60	0	0	43
103	1.0	100	10
123	1.0	100	6.8
160	1.0	100	4.3
155	2.2	220	10
199	2.2	220	6.8
280	2.2	220	4.3
262	4.7	470	10
306	4.7	470	8.2
357	4.7	470	6.8
421	4.7	470	5.6
530	4.7	470	4.3

$$V_H \approx \frac{4.3 R_H}{R_L} + 0.06$$

$$\Delta V_{th(lower)} \approx 10 R_H \times 10^{-6}$$

where: $R_H \leq 1.0 \text{ k}\Omega$

$43 \text{ k}\Omega \geq R_L \geq 4.3 \text{ k}\Omega$

Comparator hysteresis can be increased with the addition of resistor R_H . The hysteresis equation has been simplified and does not account for the change of input current I_{in} as V_{in} crosses the comparator threshold (Figure 8). An increase of the lower threshold $\Delta V_{th(lower)}$ will be observed due to I_{in} which is typically $10 \mu\text{A}$ at 4.3 V. The equations are accurate to $\pm 10\%$ with R_H less than $1.0 \text{ k}\Omega$ and R_L between $4.3 \text{ k}\Omega$ and $43 \text{ k}\Omega$.

Figure 15. Low Voltage Microprocessor Reset With Additional Hysteresis (MC3X164-5 Shown)

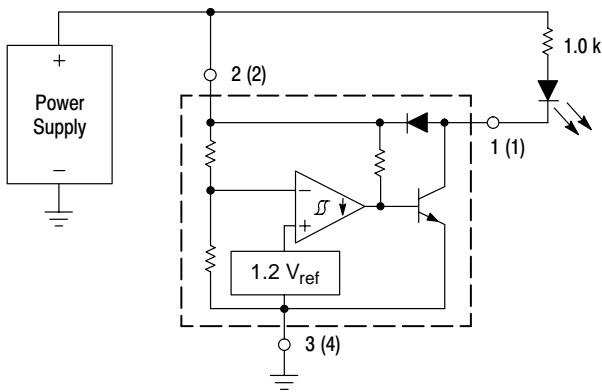

Figure 16. Voltage Monitor

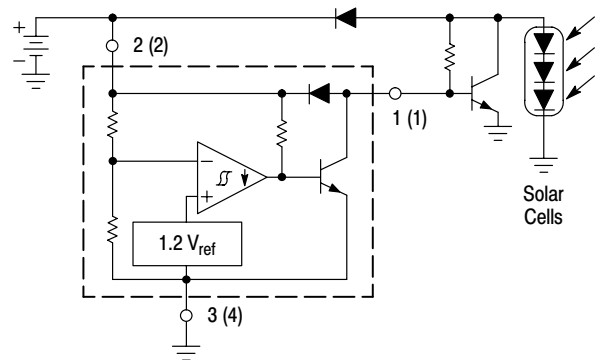
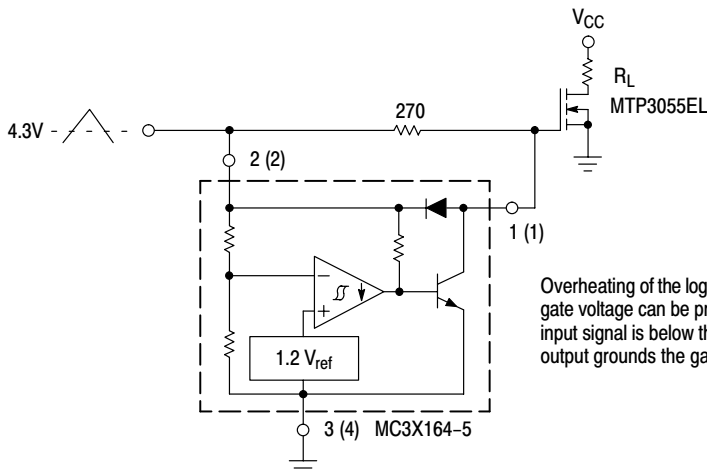

Figure 17. Solar Powered Battery Charger



Overheating of the logic level power MOSFET due to insufficient gate voltage can be prevented with the above circuit. When the input signal is below the 4.3 V threshold of the MC3X164-5, its output grounds the gate of the L² MOSFET.

Figure 18. MOSFET Low Voltage Gate Drive Protection Using the MC3X164-5

MC34164, MC33164, NCV33164

ORDERING INFORMATION

Device	Package	Shipping†
MC33164D-3	SOIC-8	98 Units / Rail
MC33164D-3R2	SOIC-8	2500 Units / Tape & Reel
NCV33164D-3R2*	SOIC-8	2500 Units / Tape & Reel
MC33164DM-3R2	Micro8	4000 Units / Tape & Reel
MC33164P-3	TO-92	2000 Units / Box
MC33164P-3RA	TO-92	2000 Units / Tape & Reel
MC33164P-3RP	TO-92	2000 Units / Pack
MC33164D-5	SOIC-8	98 Units / Rail
MC33164D-5R2	SOIC-8	2500 Units / Tape & Reel
MC33164D-5R2G	SOIC-8 (Pb-Free)	2500 Units / Tape & Reel
NCV33164D-5R2*	SOIC-8	2500 Units / Tape & Reel
MC33164DM-5R2	Micro8	4000 Units / Tape & Reel
MC33164DM-5R2G	Micro8 (Pb-Free)	4000 Units / Tape & Reel
MC33164P-5	TO-92	2000 Units / Box
MC33164P-5RA	TO-92	2000 Units / Tape & Reel
MC33164P-5RP	TO-92	2000 Units / Pack
MC34164D-3	SOIC-8	98 Units / Rail
MC34164D-3R2	SOIC-8	2500 Units / Tape & Reel
MC34164DM-3R2	Micro8	4000 Units / Tape & Reel
MC34164P-3	TO-92	2000 Units / Box
MC34164P-3RP	TO-92	2000 Units / Pack
MC34164D-5	SOIC-8	98 Units / Rail
MC34164D-5R2	SOIC-8	2500 Units / Tape & Reel
MC34164DM-5R2	Micro8	4000 Units / Tape & Reel
MC34164SN-5T1	TSOP-5	3000 Units / Tape & Reel
MC34164P-5	TO-92	2000 Units / Box
MC34164P-5RA	TO-92	2000 Units / Tape & Reel
MC34164P-5RP	TO-92	2000 Units / Pack

*NCV33164: $T_{low} = -40^{\circ}\text{C}$, $T_{high} = +125^{\circ}\text{C}$. Guaranteed by design. NCV prefix is for automotive and other applications requiring site and change control.

†For information on tape and reel specifications, including part orientation and tape sizes, please refer to our Tape and Reel Packaging Specifications Brochure, BRD8011/D.

MC34164, MC33164, NCV33164

PIN CONNECTIONS AND MARKING DIAGRAMS

TSOP-5
SN SUFFIX
CASE 483

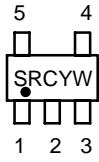

SOIC-8
D SUFFIX
CASE 751

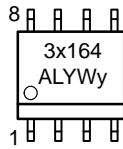

Micro8
MC33164DM
CASE 846A

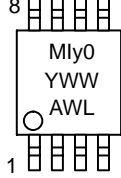

Micro8
MC34164DM
CASE 846A

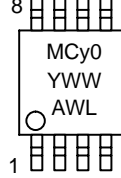

TO-92
MC3x164P-y
CASE 29

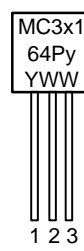

TO-92
MC3x164P-yRA
MC3x164P-yRP
CASE 29

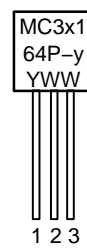

SRC = Device Code
 x = Device Number 3 or 4
 y = Suffix Number 3 or 5
 A = Assembly Location
 WL, L = Wafer Lot
 YY, Y = Year
 WW, W = Work Week

MC34164, MC33164, NCV33164

PACKAGE DIMENSIONS

TO-226AA
P SUFFIX
CASE 29-11
ISSUE AL

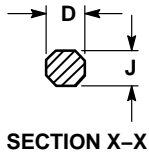
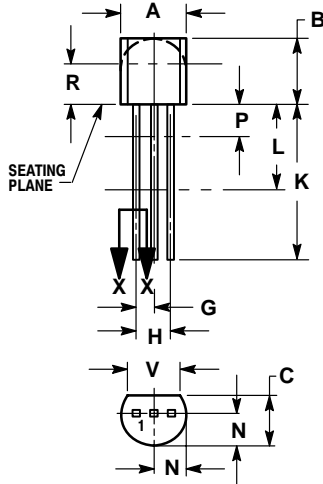

NOTES:

1. DIMENSIONING AND TOLERANCING PER ANSI Y14.5M, 1982.
2. CONTROLLING DIMENSION: INCH.
3. CONTOUR OF PACKAGE BEYOND DIMENSION R IS UNCONTROLLED.
4. LEAD DIMENSION IS UNCONTROLLED IN P AND BEYOND DIMENSION K MINIMUM.

DIM	INCHES		MILLIMETERS	
	MIN	MAX	MIN	MAX
A	0.175	0.205	4.45	5.20
B	0.170	0.210	4.32	5.33
C	0.125	0.165	3.18	4.19
D	0.016	0.021	0.407	0.533
G	0.045	0.055	1.15	1.39
H	0.095	0.105	2.42	2.66
J	0.015	0.020	0.39	0.50
K	0.500	---	12.70	---
L	0.250	---	6.35	---
N	0.080	0.105	2.04	2.66
P	---	0.100	---	2.54
R	0.115	---	2.93	---
V	0.135	---	3.43	---

PACKAGE DIMENSIONS

TSOP-5
SN SUFFIX
PLASTIC PACKAGE
CASE 483-01
ISSUE C

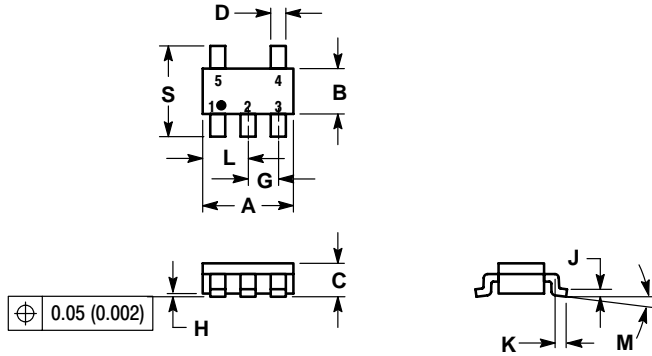

- NOTES:
1. DIMENSIONING AND TOLERANCING PER ANSI Y14.5M, 1982.
 2. CONTROLLING DIMENSION: MILLIMETER.
 3. MAXIMUM LEAD THICKNESS INCLUDES LEAD FINISH THICKNESS. MINIMUM LEAD THICKNESS IS THE MINIMUM THICKNESS OF BASE MATERIAL.
 4. A AND B DIMENSIONS DO NOT INCLUDE MOLD FLASH, PROTRUSIONS, OR GATE BURRS.

DIM	MILLIMETERS		INCHES	
	MIN	MAX	MIN	MAX
A	2.90	3.10	0.1142	0.1220
B	1.30	1.70	0.0512	0.0669
C	0.90	1.10	0.0354	0.0433
D	0.25	0.50	0.0098	0.0197
G	0.85	1.05	0.0335	0.0413
H	0.013	0.100	0.0005	0.0040
J	0.10	0.26	0.0040	0.0102
K	0.20	0.60	0.0079	0.0236
L	1.25	1.55	0.0493	0.0610
M	0	10	0	10
S	2.50	3.00	0.0985	0.1181

SOLDERING FOOTPRINT

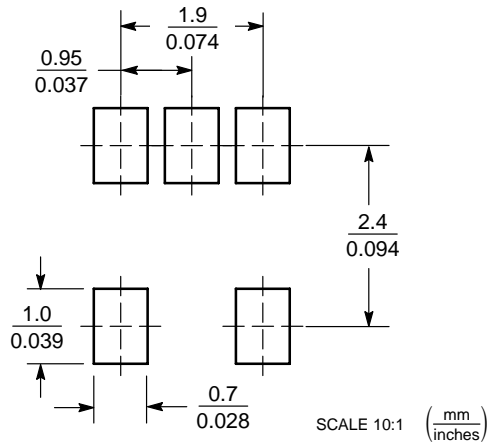

MC34164, MC33164, NCV33164

PACKAGE DIMENSIONS

SOIC-8 D SUFFIX CASE 751-07 ISSUE AB

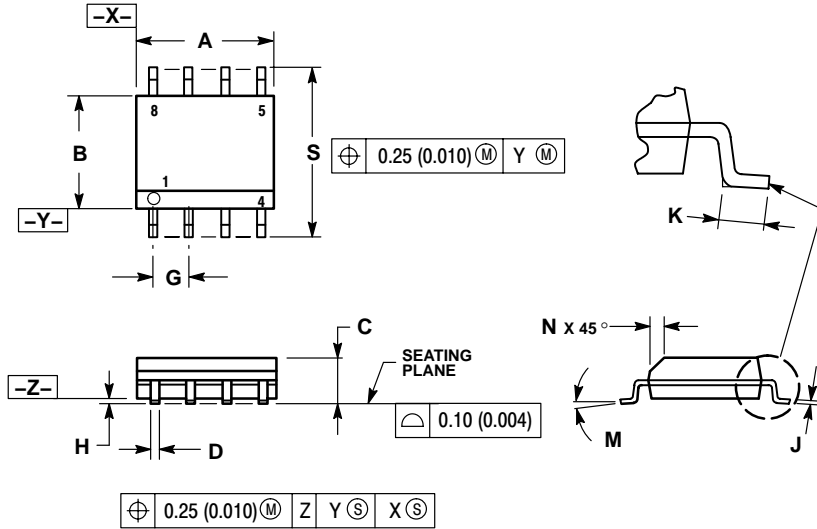

NOTES:

1. DIMENSIONING AND TOLERANCING PER ANSI Y14.5M, 1982.
2. CONTROLLING DIMENSION: MILLIMETER.
3. DIMENSION A AND B DO NOT INCLUDE MOLD PROTRUSION.
4. MAXIMUM MOLD PROTRUSION 0.15 (0.006) PER SIDE.
5. DIMENSION D DOES NOT INCLUDE DAMBAR PROTRUSION. ALLOWABLE DAMBAR PROTRUSION SHALL BE 0.127 (0.005) TOTAL IN EXCESS OF THE D DIMENSION AT MAXIMUM MATERIAL CONDITION.
6. 751-01 THRU 751-06 ARE OBSOLETE. NEW STANDARD IS 751-07.

DIM	MILLIMETERS		INCHES	
	MIN	MAX	MIN	MAX
A	4.80	5.00	0.189	0.197
B	3.80	4.00	0.150	0.157
C	1.35	1.75	0.053	0.069
D	0.33	0.51	0.013	0.020
G	1.27 BSC		0.050 BSC	
H	0.10	0.25	0.004	0.010
J	0.19	0.25	0.007	0.010
K	0.40	1.27	0.016	0.050
M	0°	8°	0°	8°
N	0.25	0.50	0.010	0.020
S	5.80	6.20	0.228	0.244

SOLDERING FOOTPRINT*

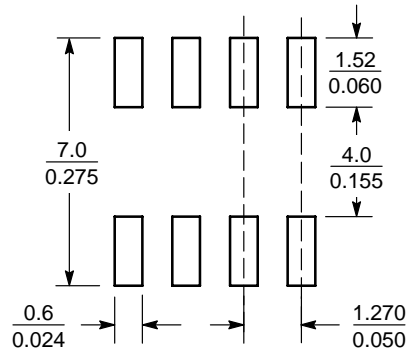

SCALE 6:1 $\left(\frac{\text{mm}}{\text{inches}}\right)$

*For additional information on our Pb-Free strategy and soldering details, please download the ON Semiconductor Soldering and Mounting Techniques Reference Manual, SOLDERRM/D.

MC34164, MC33164, NCV33164

PACKAGE DIMENSIONS

Micro8
DM SUFFIX
CASE 846A-02
ISSUE F

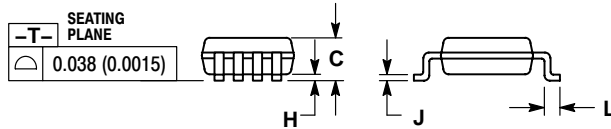
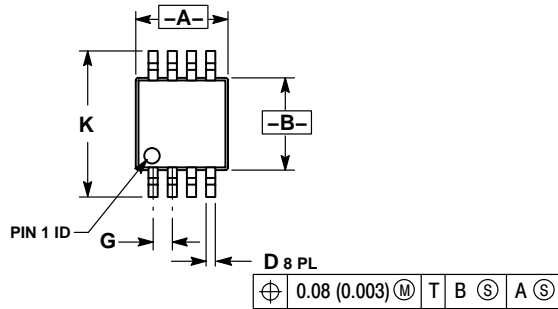

NOTES:

1. DIMENSIONING AND TOLERANCING PER ANSI Y14.5M, 1982.
2. CONTROLLING DIMENSION: MILLIMETER.
3. DIMENSION A DOES NOT INCLUDE MOLD FLASH, PROTRUSIONS OR GATE BURRS. MOLD FLASH, PROTRUSIONS OR GATE BURRS SHALL NOT EXCEED 0.15 (0.006) PER SIDE.
4. DIMENSION B DOES NOT INCLUDE INTERLEAD FLASH OR PROTRUSION. INTERLEAD FLASH OR PROTRUSION SHALL NOT EXCEED 0.25 (0.010) PER SIDE.
5. 846A-01 OBSOLETE, NEW STANDARD 846A-02.

DIM	MILLIMETERS		INCHES	
	MIN	MAX	MIN	MAX
A	2.90	3.10	0.114	0.122
B	2.90	3.10	0.114	0.122
C	---	1.10	---	0.043
D	0.25	0.40	0.010	0.016
G	0.65 BSC		0.026 BSC	
H	0.05	0.15	0.002	0.006
J	0.13	0.23	0.005	0.009
K	4.75	5.05	0.187	0.199
L	0.40	0.70	0.016	0.028

SOLDERING FOOTPRINT*

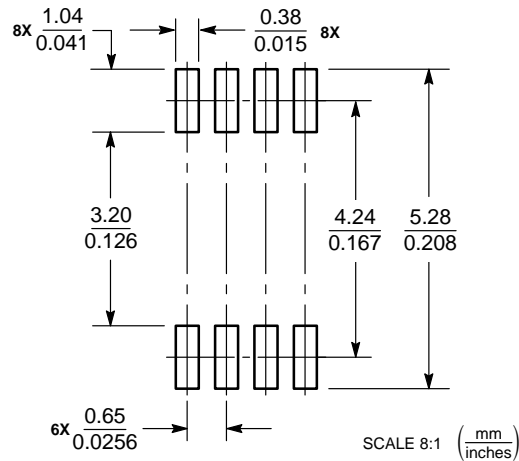

*For additional information on our Pb-Free strategy and soldering details, please download the ON Semiconductor Soldering and Mounting Techniques Reference Manual, SOLDERRM/D.

Micro8 is a trademark of International Rectifier.

ON Semiconductor and are registered trademarks of Semiconductor Components Industries, LLC (SCILLC). SCILLC reserves the right to make changes without further notice to any products herein. SCILLC makes no warranty, representation or guarantee regarding the suitability of its products for any particular purpose, nor does SCILLC assume any liability arising out of the application or use of any product or circuit, and specifically disclaims any and all liability, including without limitation special, consequential or incidental damages. "Typical" parameters which may be provided in SCILLC data sheets and/or specifications can and do vary in different applications and actual performance may vary over time. All operating parameters, including "Typicals" must be validated for each customer application by customer's technical experts. SCILLC does not convey any license under its patent rights nor the rights of others. SCILLC products are not designed, intended, or authorized for use as components in systems intended for surgical implant into the body, or other applications intended to support or sustain life, or for any other application in which the failure of the SCILLC product could create a situation where personal injury or death may occur. Should Buyer purchase or use SCILLC products for any such unintended or unauthorized application, Buyer shall indemnify and hold SCILLC and its officers, employees, subsidiaries, affiliates, and distributors harmless against all claims, costs, damages, and expenses, and reasonable attorney fees arising out of, directly or indirectly, any claim of personal injury or death associated with such unintended or unauthorized use, even if such claim alleges that SCILLC was negligent regarding the design or manufacture of the part. SCILLC is an Equal Opportunity/Affirmative Action Employer. This literature is subject to all applicable copyright laws and is not for resale in any manner.

PUBLICATION ORDERING INFORMATION

LITERATURE FULFILLMENT:
Literature Distribution Center for ON Semiconductor
P.O. Box 5163, Denver, Colorado 80217 USA
Phone: 303-675-2175 or 800-344-3860 Toll Free USA/Canada
Fax: 303-675-2176 or 800-344-3867 Toll Free USA/Canada
Email: orderlit@onsemi.com

N. American Technical Support: 800-282-9855 Toll Free
USA/Canada

Japan: ON Semiconductor, Japan Customer Focus Center
2-9-1 Kamimeguro, Meguro-ku, Tokyo, Japan 153-0051
Phone: 81-3-5773-3850

ON Semiconductor Website: <http://onsemi.com>

Order Literature: <http://www.onsemi.com/litorder>

For additional information, please contact your local Sales Representative.