

PCB Connector

PCB Connector Series

KLS1-XA1-2.00 Pitch=2.00mm TYPE

Electrical Specification:

Rated Voltage: 250V AC/DC
 Rated Current: 3A
 Contact Resistance: 0.02 Ohm max
 Insulation Resistance: 1000M Ohm min
 Withstand voltage: 1000V AC/MIN
 Temperature range for usage : -40°C~+105°C
 P.C board thickness : 0.8~1.6mm

Material:

Housing: PA66 UL94V-2
 Contacts: Phosphor Bronze
 Plating: Tin 50u" over 100u" nickel
 Wire range : AWG#30~#22



Housing

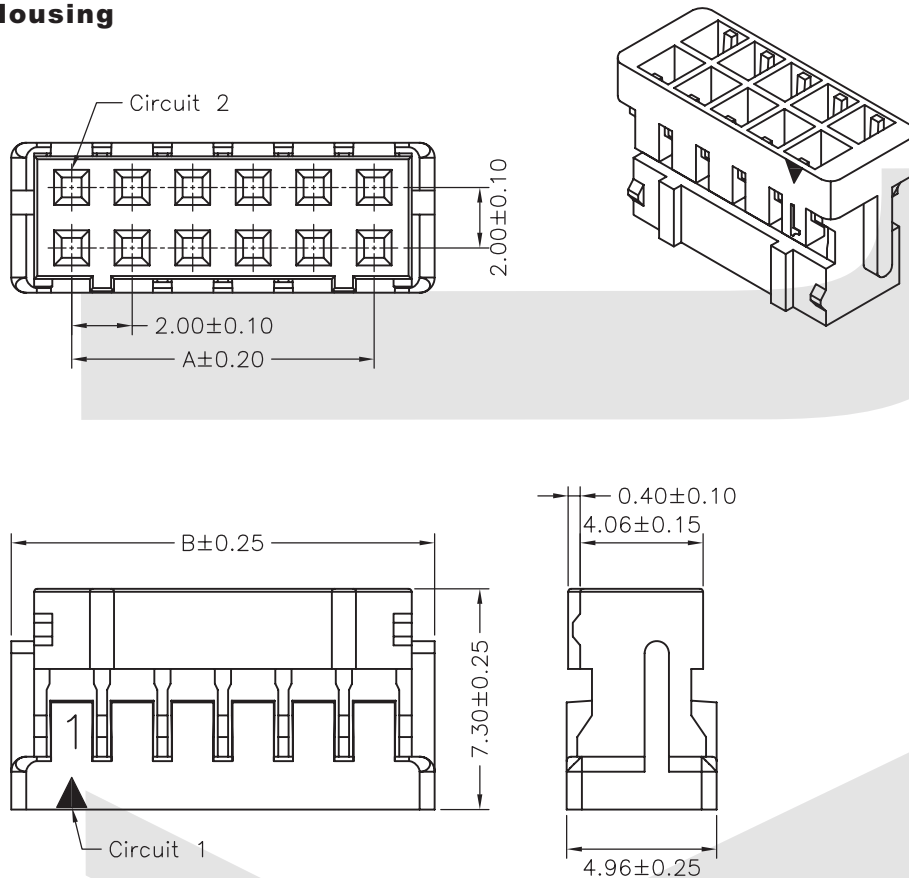

PART NO.	Dimensions	
	A	B
04	2.00	6.00
06	4.00	8.00
08	6.00	10.00
10	8.00	12.00
12	10.00	14.00
14	12.00	16.00
16	14.00	18.00
18	16.00	20.00
20	18.00	22.00
22	20.00	24.00
24	22.00	26.00
26	24.00	28.00
28	26.00	30.00
30	28.00	32.00
32	30.00	34.00
34	32.00	36.00
36	34.00	38.00
38	36.00	40.00
40	38.00	42.00

ORDER INFORMATION

Product NO.: KLS1-XA1-2.00-XX-H

Series No. _____ Type: H=Housing T=Terminal
 Pitch: 2.00=2.00mm S=Straight Male pin R=Right Male pin
 PIN Number: 4 ~ 40Pin

PCB Connector Series

KLS1-XA1-2.00 Pitch=2.00mm TYPE

Electrical Specification:

Rated Voltage: 250V AC/DC
 Rated Current: 3A
 Contact Resistance: 0.02 Ohm max
 Insulation Resistance: 1000M Ohm min
 Withstand voltage: 1000V AC/MIN
 Temperature range for usage : -40°C~+105°C
 P.C board thickness : 0.8~1.6mm

Material:

Contacts: Phosphor Bronze
 Plating: Tin 50u" over 100u" nickel
 Wire range : AWG#30~#22



Terminal

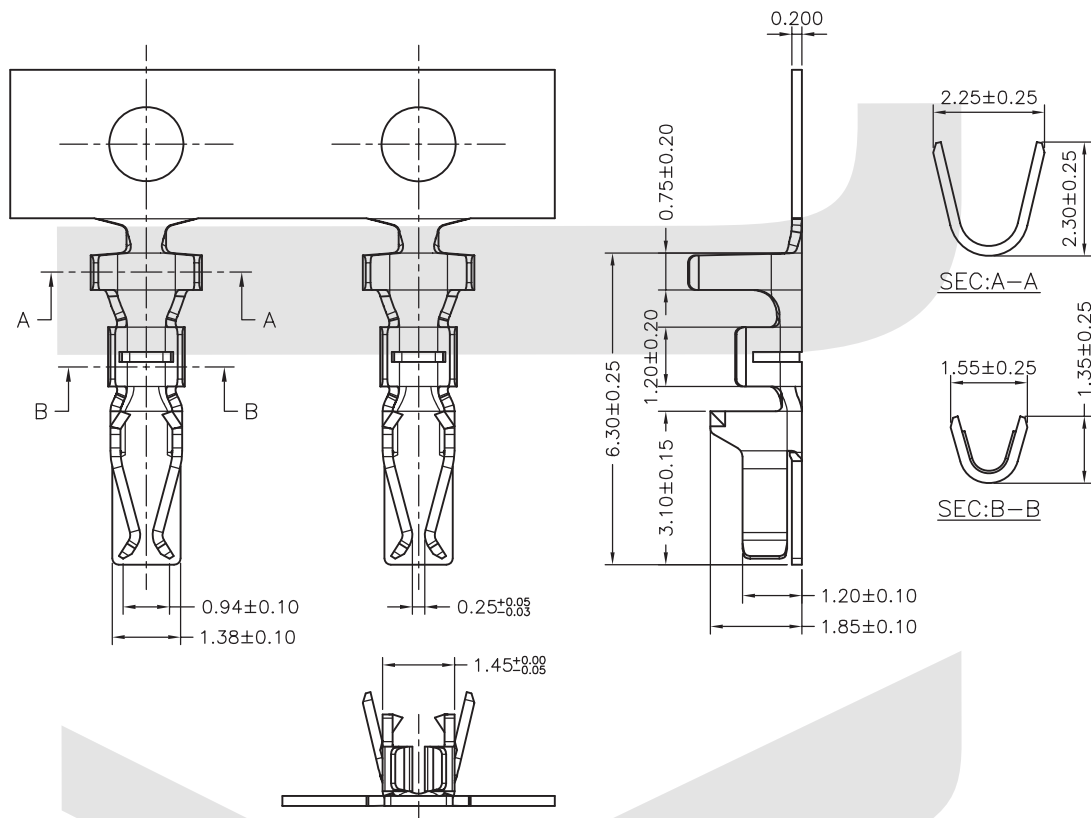

ORDER INFORMATION

Product NO.: KLS1-XA1-2.00-T

Series No. _____
 Pitch: 2.00=2.00mm

Type: H=Housing T=Terminal
 S=Straight Male pin R=Right Male pin

PCB Connector Series

KLS1-XA1-2.00 Pitch=2.00mm TYPE

Electrical Specification:

- Rated Voltage: 250V AC.DC
- Rated Current: 3A
- Contact Resistance: 0.02 Ohm max
- Insulation Resistance: 1000M Ohm min
- Withstand voltage: 1000V AC/MIN
- Temperature range for usage : -40°C~+105°C
- P.C board thickness : 0.8~1.6mm

Material:

- Housing: PA66 UL94V-2
- Contacts: Brass
- Plating: Tin 50u" over 100u" nickel
- Wire range : AWG#30~#22



Straight Male pin

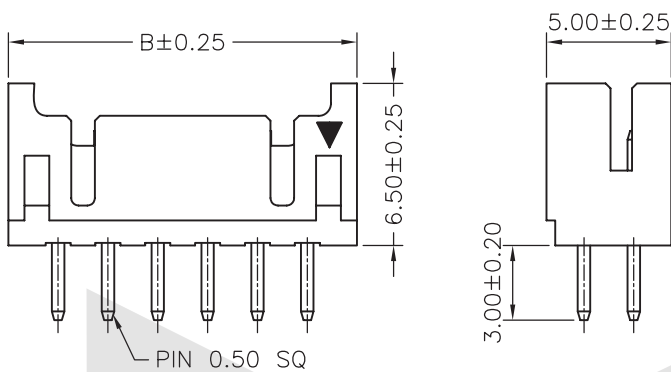
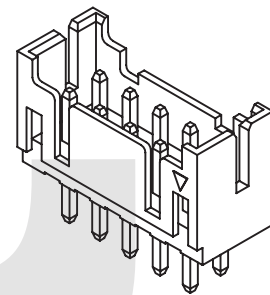
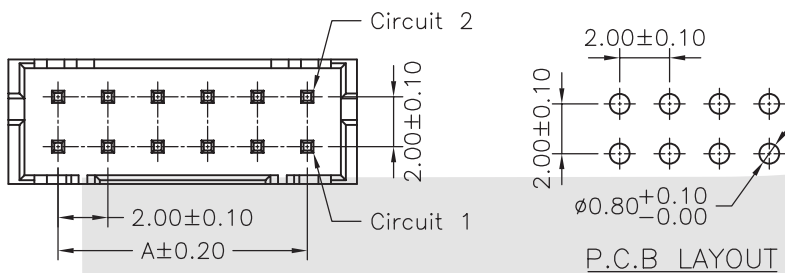

PART NO.	Dimensions	
	A	B
04	2.00	6.00
06	4.00	8.00
08	6.00	10.00
10	8.00	12.00
12	10.00	14.00
14	12.00	16.00
16	14.00	18.00
18	16.00	20.00
20	18.00	22.00
22	20.00	24.00
24	22.00	26.00
26	24.00	28.00
28	26.00	30.00
30	28.00	32.00
32	30.00	34.00
34	32.00	36.00
36	34.00	38.00
38	36.00	40.00
40	38.00	42.00

ORDER INFORMATION

Product NO.: KLS1-XA1-2.00-XX-S

Series No. _____ Type: H=Housing T=Terminal
 Pitch: 2.00=2.00mm S=Straight Male pin R=Right Male pin
 PIN Number: 2 ~ 20Pin

PCB Connector Series

KLS1-XA1-2.00 Pitch=2.00mm TYPE

Electrical Specification:

Rated Voltage: 250V AC/DC
 Rated Current: 3A
 Contact Resistance: 0.02 Ohm max
 Insulation Resistance: 1000M Ohm min
 Withstand voltage: 1000V AC/MIN
 Temperature range for usage : -40°C~+105°C
 P.C board thickness : 0.8~1.6mm

Material:

Housing: PA66 UL94V-2
 Contacts: Brass
 Plating: Tin 50u" over 100u" nickel
 Wire range : AWG#30~#22



SMT

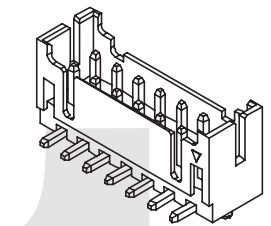
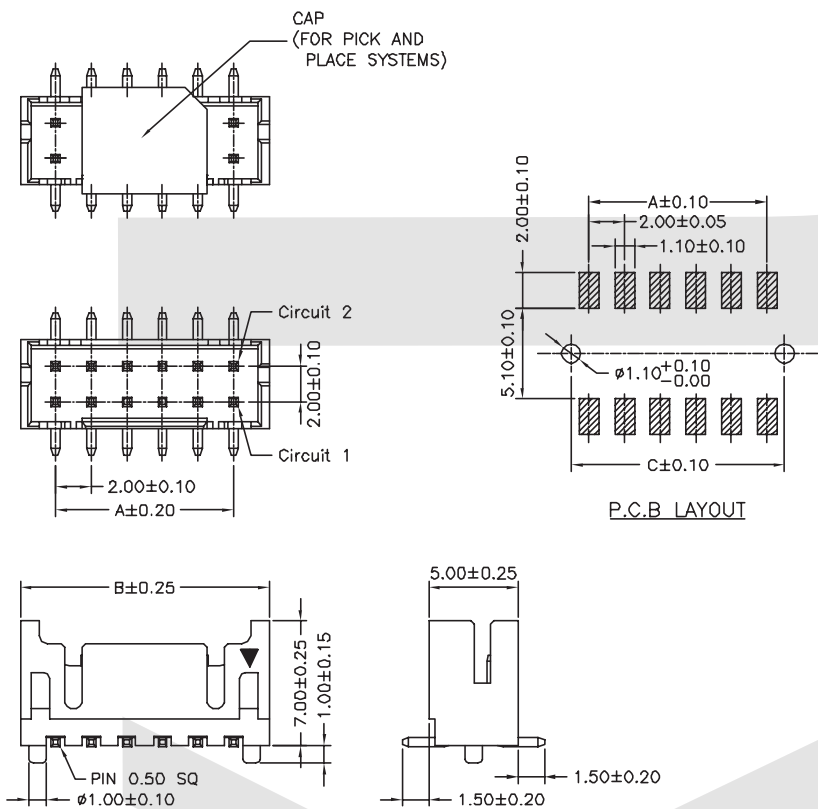

PART NO.	Dimensions	
	A	B
04	2.00	6.00
06	4.00	8.00
08	6.00	10.00
10	8.00	12.00
12	10.00	14.00
14	12.00	16.00
16	14.00	18.00
18	16.00	20.00
20	18.00	22.00
22	20.00	24.00
24	22.00	26.00
26	24.00	28.00
28	26.00	30.00
30	28.00	32.00
32	30.00	34.00
34	32.00	36.00
36	34.00	38.00
38	36.00	40.00
40	38.00	42.00

ORDER INFORMATION

Product NO.: KLS1-XA1-2.00-XX-M

Series No. _____ Type: M=SMT

Pitch: 2.00=2.00mm _____ PIN Number: 2 ~ 20Pin

All specification & dimensions are subject to change, please call your nearest KLS sales representative for update information