

## PROTECTION PRODUCTS

### Description

The STF203 is a combination EMI filter and line termination device with integrated TVS diodes for use on upstream USB ports. It is constructed using a proprietary technology that allows passive components and TVS diodes to be integrated in the same package. Each device will provide termination, filtering, and ESD protection for one upstream USB port. The STF203 is an easily implemented solution for meeting the requirements of revision 1.1 of the Universal Serial Bus specification.

Line termination is achieved with series resistors on both the D+ and D- USB lines. The value of series resistance added to the output impedance of the USB driver must be as close to possible to the 45 $\Omega$  characteristic impedance of the cable (90 $\Omega$  balanced) to minimize transmission line reflections. They are available with resistor values of 15 $\Omega$  (STF203-15), 22 $\Omega$  (STF203-22), and 33 $\Omega$  (STF203-33). The 1.5k $\Omega$  pull-up resistor is required by the USB specification to identify the equipment as either a full-speed (connected to D+ line) or low-speed (connected to D- line) device. The 47pF capacitors are required to bypass high frequency energy to ground and to control the edge rate of the USB signals. The TVS diodes provide ESD protection of both (D+ and D-) data lines and the voltage bus ( $V_{BUS}$ ). The TVS diodes on the input/output pins provide suppression of ESD voltages in excess of  $\pm 15\text{kV}$  (air discharge) and  $\pm 8\text{kV}$  (contact discharge) per IEC 61000-4-2, level 4. The TVS diode on the  $V_{BUS}$  pin will suppress ESD discharges in excess of 25kV per IEC 61000-4-2.

### Features

- ◆ Bidirectional EMI/RFI filtering and line termination with integrated ESD protection
- ◆ ESD protection for USB power ( $V_{BUS}$ ) and data lines (D+ and D-) to  
**IEC 61000-4-2 (ESD)  $\pm 15\text{kV}$  (air),  $\pm 8\text{kV}$  (contact)**  
**IEC 61000-4-4 (EFT) 40A (5/50ns)**
- ◆ Filtering and termination for one USB port
- ◆ Series resistors: 15 $\Omega$ , 22 $\Omega$ , and 33 $\Omega$
- ◆ Low TVS operating voltage (5.25V)
- ◆ Low leakage current
- ◆ Small SC70-6L package
- ◆ Solid-state technology

### Mechanical Characteristics

- ◆ EIAJ SC70-6L package
- ◆ RoHS/WEEE Compliant
- ◆ Molding compound flammability rating: UL 94V-0
- ◆ Marking : Marking Code
- ◆ Packaging : Tape and Reel per EIA 481

### Applications

- ◆ USB Ports
- ◆ Cellular Handsets
- ◆ PDAs
- ◆ Pagers
- ◆ Digital Cameras
- ◆ PC Peripherals
- ◆ MP3 Players

### Circuit Diagram

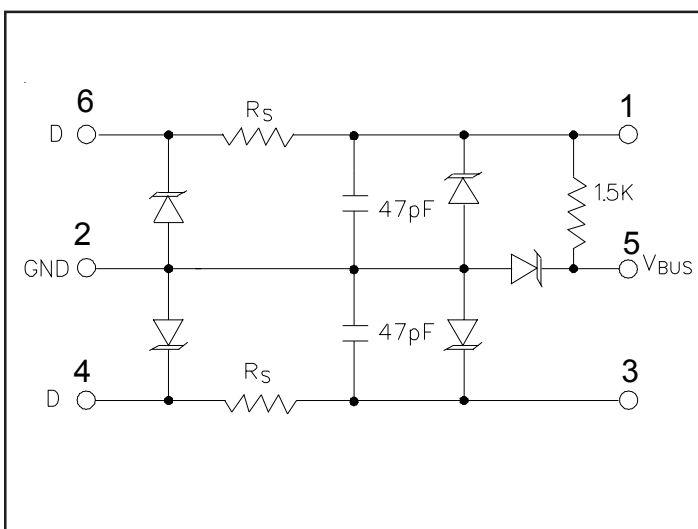

### Schematic and PIN Configuration

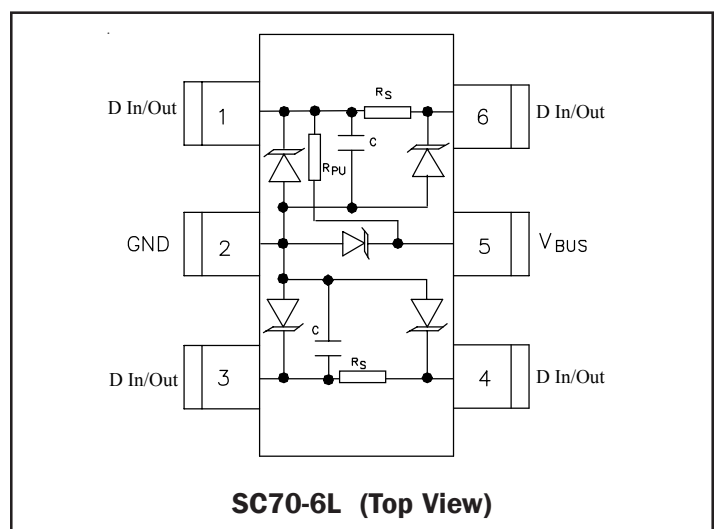

**PROTECTION PRODUCTS**
**Absolute Maximum Rating**

Rating	Symbol	Value	Units
Steady-State Power	$P_{SS}$	100	mW
ESD Air Discharge per IEC 61000-4-2 ESD Contact Discharge per IEC 61000-4-2	$V_{ESD}$	16 10	kV
Lead Soldering Temperature	$T_L$	260 (10 sec.)	°C
Operating Temperature	$T_J$	-40 to +125	°C
Storage Temperature	$T_{STG}$	-55 to +150	°C

**Electrical Characteristics**

<b>STF203-XX</b>						
Parameter	Symbol	Conditions	Minimum	Typical	Maximum	Units
TVS Reverse Stand-Off Voltage	$V_{RWM}$				5.25	V
TVS Reverse Breakdown Voltage	$V_{BR}$	$I_t = 1\text{mA}$	6			V
TVS Reverse Leakage Current	$I_R$	$V_{RWM} = 5.25\text{V}$ , $T=25\text{ °C}$ Between and data (D+, D-) pin and Ground			5	μA
TVS Reverse Leakage Current	$I_R$	Each Line			1	μA
Series Resistance (STF203-15)	$R_S$	Each Line	13.5	15	16.5	Ohms
Series Resistance (STF203-22)	$R_S$	Each Line	20	22	24	Ohms
Series Resistance (STF203-33)	$R_S$	Each Line	30	33	36	Ohms
Pull Up Resistance	$R_{PU}$		1.35	1.5	1.65	kOhms
Capacitor	C	Each Line		47		pF
Total Capacitance	$C_{TOT}$	Between Input or Output or Ground $V_R = 0\text{V}$ , $f = 1\text{MHz}$		60		pF

PROTECTION PRODUCTS

Typical Characteristics

ESD Clamping (8kV Contact)

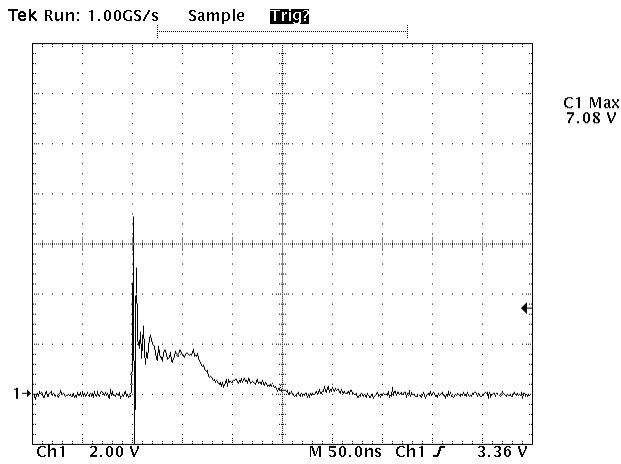

ESD Clamping (15kV Air)

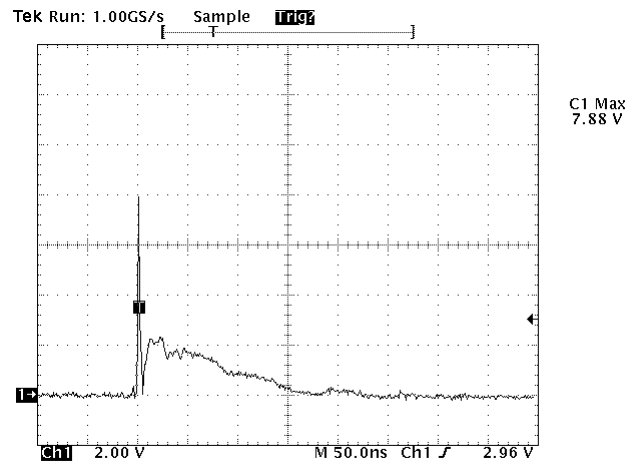

Typical Insertion Loss

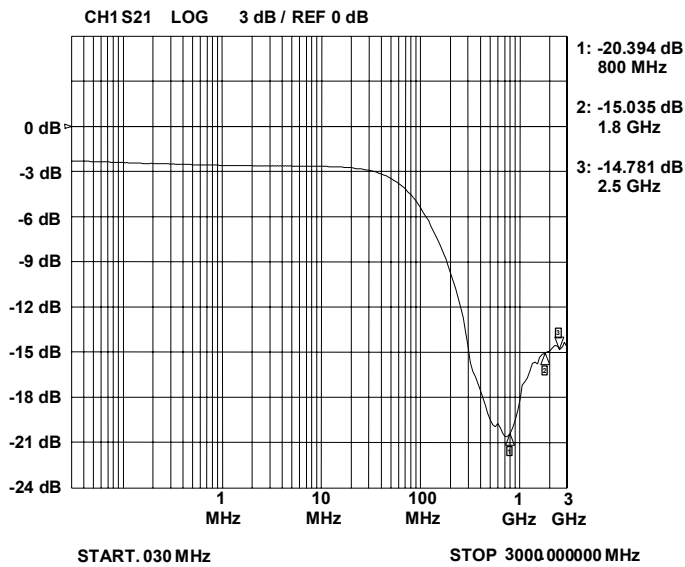

Analog Crosstalk (D+ to D-)

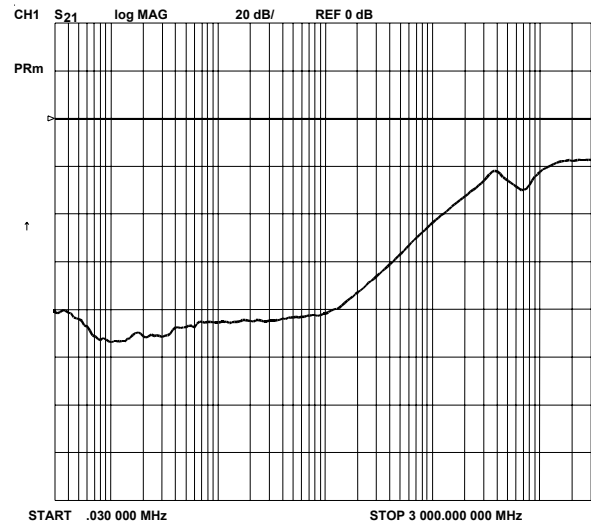

**PROTECTION PRODUCTS**
**Applications Information**
**Device Connection**

The STF203 is designed to provide termination, EMI filtering and ESD protection for one USB port. The device is connected as follows:

**1. Full-Speed Devices:** For full-speed devices the pull-up resistor is connected to the D+ line. Route the D+ line from the connector to pin 1 of the STF203. Pin 6 is connected to the D+ line of the IC. Route the D- line from the connector to pin 3. Pin 4 is connected to the D- line of the IC. Pin 5 is connected to the voltage supply line ( $V_{BUS}$ ). Pin 2 is connected to ground. Note that the input and output connections may be reversed if necessary (See Figure 3).

**2. Low-Speed Devices:** For low speed devices the pull-up resistor is connected to the D- line. Route the D- line from the connector to pin 1 of the STF203. Pin 6 is connected to the D- line of the IC. Route the D+ line from the connector to pin 3. Pin 4 is connected to the D+ line of the IC. Pin 5 is connected to the voltage supply line ( $V_{BUS}$ ). Pin 2 is connected to ground. Note that the input and output connections may be reversed if necessary (See Figure 4).

**USB Port Design Considerations**

The Universal Serial Bus (USB) specification requires termination and filtering components for proper operation. In addition, an open USB socket is vulnerable to hazardous ESD discharges in excess of 15kV. These discharges can occur on the data lines or the voltage bus. The STF203 is an easily implemented solution that is designed to meet the termination and EMI filter requirements of the USB specification revision 1.1. It also provides ESD protection to IEC 61000-4-2, level 4.

USB line termination is achieved with series resistors on both the D+ and D- lines. These resistors preserve signal integrity by matching the cable impedance to that of the differential driver. A 1.5k $\Omega$  pull-up resistor is used to identify an upstream port on either the D+ (full speed devices) or the D- (low speed devices) data line. Capacitors are used for EMI suppression. TVS diodes provide ESD protection of both (D+ and D-) data lines and the voltage bus ( $V_{BUS}$ ). The STF203 integrates all of these components in a small SC-70 package. This integrated solution simplifies design and requires minimal board space.

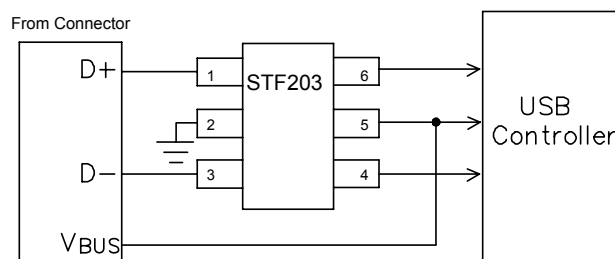
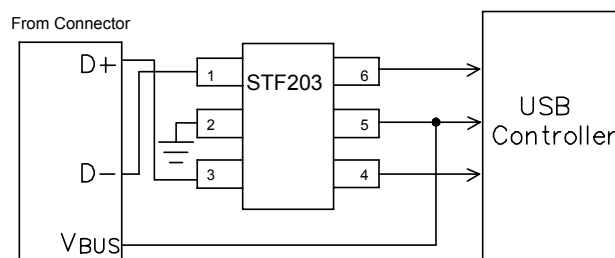
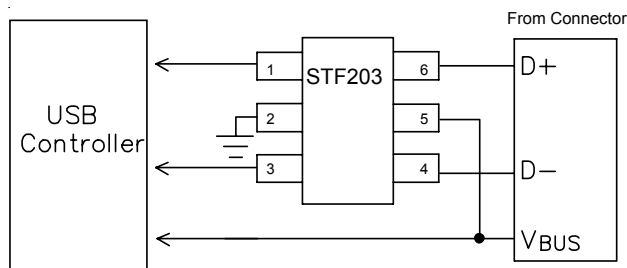
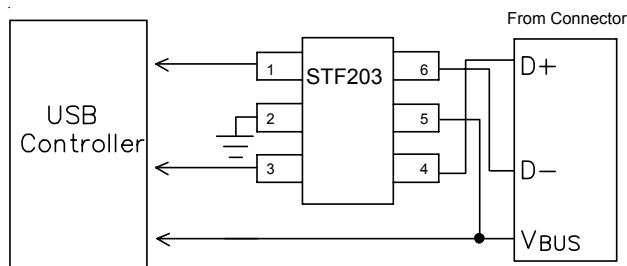
**Figure 1 - Preferred Connection Diagram (Full Speed Devices)**

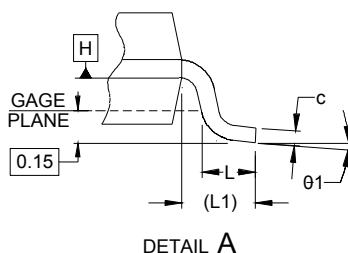
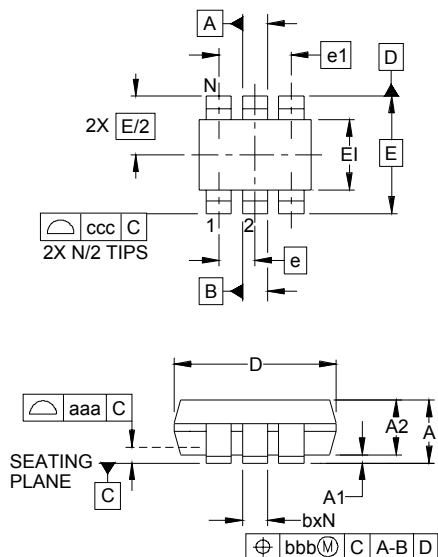
**Figure 2 - Preferred Connection Diagram (Low Speed Devices)**

**Figure 3 - Alternate Connection Diagram (Full Speed Devices)**

**Figure 4 - Alternate Connection Diagram (Low Speed Devices)**

**PROTECTION PRODUCTS**
**Outline Drawing - SC70 6L**

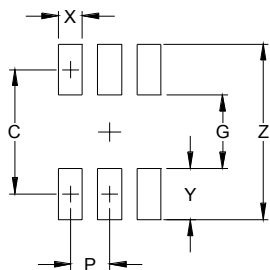
DIM	DIMENSIONS					
	INCHES			MILLIMETERS		
	MIN	NOM	MAX	MIN	NOM	MAX
A	-	-	.043	-	-	1.10
A1	.000	-	.004	0.00	-	0.10
A2	.028	.035	.039	0.70	0.90	1.00
b	.006	-	.012	0.15	-	0.30
c	.003	-	.009	0.08	-	0.22
D	.075	.079	.083	1.90	2.00	2.10
E1	.045	.049	.053	1.15	1.25	1.35
E	.083 BSC			2.10 BSC		
e	.026 BSC			0.65 BSC		
e1	.051			1.30 BSC		
L	.010	.014	.018	0.26	0.36	0.46
L1	(.017)			(0.42)		
N	6			6		
theta 1	0°	-	8°	0°	-	8°
aaa	.004			0.10		
bbb	.004			0.10		
ccc	.012			0.30		

**NOTES:**

1. CONTROLLING DIMENSIONS ARE IN MILLIMETERS (ANGLES IN DEGREES).
2. DATUMS **-A-** AND **-B-** TO BE DETERMINED AT DATUM PLANE **-H-**
3. DIMENSIONS "E1" AND "D" DO NOT INCLUDE MOLD FLASH, PROTRUSIONS OR GATE BURRS.
4. REFERENCE JEDEC STD MO-203, VARIATION AB.

**Land Pattern - SC70 6L**

DIMENSIONS		
DIM	INCHES	MILLIMETERS
C	(.073)	(1.85)
G	.039	1.00
P	.026	0.65
X	.016	0.40
Y	.033	0.85
Z	.106	2.70

**NOTES:**

1. THIS LAND PATTERN IS FOR REFERENCE PURPOSES ONLY. CONSULT YOUR MANUFACTURING GROUP TO ENSURE YOUR COMPANY'S MANUFACTURING GUIDELINES ARE MET.

## PROTECTION PRODUCTS

### Marking

Part Number	Series Resistor	Marking Code
STF203-15	15 $\Omega$	315
STF203-22	22 $\Omega$	322
STF203-33	33 $\Omega$	333

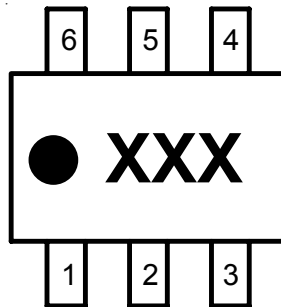

Note: XXX = Marking Code

### Ordering Information

Part Number	Lead Finish	Qty per Reel	Reel Size
STF203-15.TC	SnPb	3,000	7"
STF203-22.TC	SnPb	3,000	7"
STF203-33.TC	SnPb	3,000	7"
STF203-15.TCT	Pb free	3,000	7"
STF203-22.TCT	Pb free	3,000	7"
STF203-33.TCT	Pb free	3,000	7"

Note: Pb free finish is matte tin

### Contact Information

Semtech Corporation  
 Protection Products Division  
 200 Flynn Road, Camarillo, CA 93012  
 Phone: (805)498-2111 FAX (805)498-3804