

HOLES(4) ARE DESIGNED FOR M2.6X6mm SELF-TAPPING SCREWS USE.
 WALL MOUNTING HOLES(2) X DIA.4.5mm FOR PAN HEAD(M4) TAPPING SCREWS USE.

SECTION B-B
SCALE 2 : 3

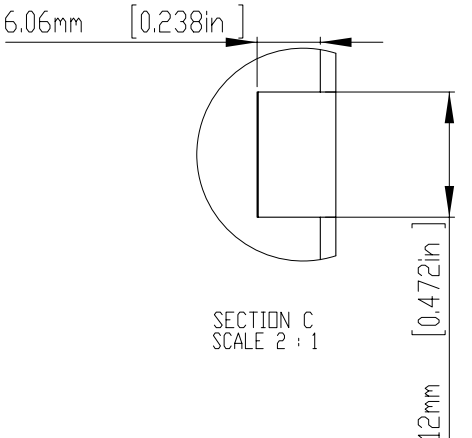

SECTION C
SCALE 2 : 1

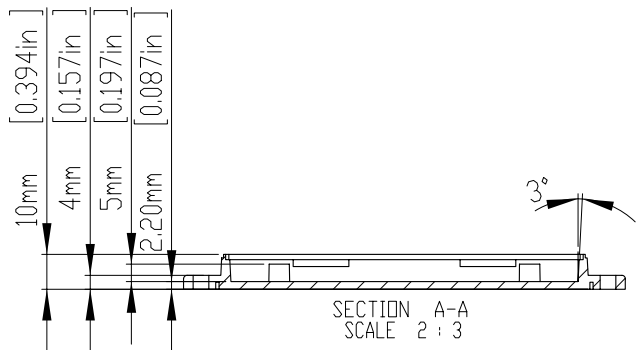

SECTION A-A
SCALE 2 : 3

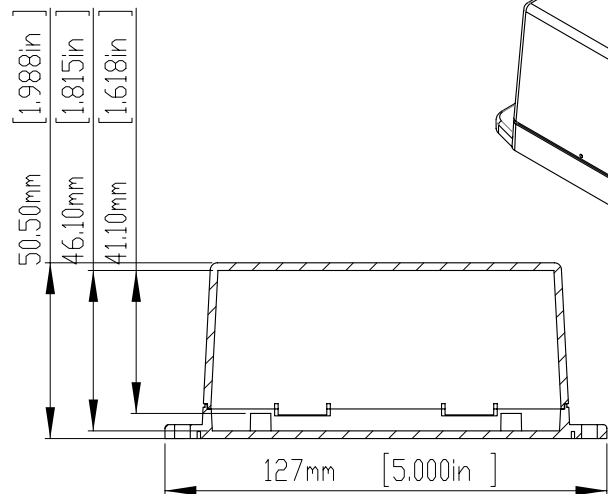

ASSEMBLY

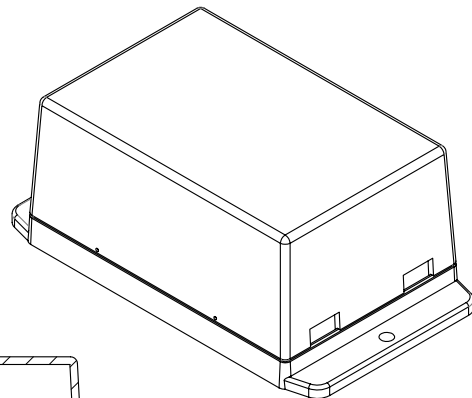

According to ISO 2768-m

Measuring DIM=L	Tolerances
0.5<L≤3.0mm	±0.1mm
3.0<L≤6.0 mm	±0.1mm
6.0<L≤30.0 mm	±0.2mm
30.0<L≤120.0 mm	±0.3mm
120.0<L≤400.0 mm	±0.5mm
400.0<L≤1000.0 mm	±0.8mm

宣又實業有限公司 GAINTA INDUSTRIES LTD.	繪圖	DRA'D BY	日期	DATE	材質	MATE.	圖名TITLE:	圖號DWG NO:	版次REVISID:
		JACKY	2013/10/01		ABS		NUB1057050		A

ITEM	DESCRIPTION	MATERIAL	COLOR	PANTONE COLOR CORD	CLOSE TO RAL CORD
1	NUB1057050BK	ABS<UL94-HB>	BLACK	PANTONE BLACK U	RAL 9005
2	NUB1057050WH	ABS<UL94-HB>	WHITE	PANTONE 420C	RAL 9002
3	NUB1057050OR	ABS<UL94-HB>	ORANGE	PANTONE 165C	RAL 2004
4	NUB1057050RD	ABS<UL94-HB>	RED	PANTONE 186C	RAL 3027

宣又實業有限公司
GAINTA INDUSTRIES LTD.

繪圖 DRA'D BY
JACKY

日期 DATE
2013/10/01

材質 MATE.
ABS

圖名TITLE:
NUB1057050

圖號DWG NO:

版次REVISID:
A