



WINSTAR Display Co.,Ltd.
華凌光電股份有限公司



Winstar Display Co., LTD

華凌光電股份有限公司



WEB: <https://www.winstar.com.tw> E-mail: sales@winstar.com.tw

SPECIFICATION

CUSTOMER : _____

MODULE NO.: WG12864B-YGH-V#N

APPROVED BY: (FOR CUSTOMER USE ONLY)	PCB VERSION:	DATA:
--	---------------------	--------------

SALES BY	APPROVED BY	CHECKED BY	PREPARED BY

VERSION	DATE	REVISED PAGE NO.	SUMMARY
I	2020/04/09		Modify Contour Drawing

RECORDS OF REVISION
DOC. FIRST ISSUE

VERSION	DATE	REVISED PAGE NO.	SUMMARY
0	2007/11/21		First issue
A	2009/06/18		Modify Timing Characteristics
B	2010/03/02		Modify View area, Active area
C	2013/04/02		Correct contour drawing Modify IC information
D	2014/04/14		Correct Luminance.
E	2016/01/27		Modify Precautions in use of LCD Modules & Static electricity test
F	2016/04/19		Modify Response Time
G	2019/08/27		Modify Material List of Components for RoHs
H	2019/12/17		Modify Precautions in use of LCD Modules
I	2020/04/09		Modify Contour Drawing

Contents

- 1.Module Classification Information
- 2.Precautions in use of LCD Modules
- 3.General Specification
- 4.Absolute Maximum Ratings
- 5.Electrical Characteristics
- 6.Optical Characteristics
- 7.Interface Pin Function
- 8.Contour Drawing &Block Diagram
- 9.Reliability
- 10.Backlight Information
- 11.Inspection specification
- 12.Material List of Components for RoHs
- 13.Recommendable Storage

1. Module Classification Information

W G 12864 B — Y G H — V#N
 ① ② ③ ④ ⑤ ⑥ ⑦ ⑧

① Brand : WINSTAR DISPLAY CORPORATION

② Display Type : H→Character Type, G→Graphic Type, X→TAB Type, O→COG Type

③ Display Font : 128 * 64 dot

④ Model serials no.

⑤ Backlight Type :

N→Without backlight	T→LED, White	L→LED, Full color
B→EL, Blue green	A→LED, Amber	J→DIP LED, Blue
D→EL, Green	R→LED, Red	K→DIP LED, White
W→EL, White	O→LED, Orange	E→DIP LED, Yellow Green
M→EL, Yellow Green	G→LED, Green	H→DIP LED, Amber
F→CCFL, White	P→LED, Blue	I→DIP LED, Red
Y→LED, Yellow Green	X→LED, Dual color	
G→LED, Green	C→LED, Full color	

⑥ LCD Mode :

B→TN Positive, Gray	V→FSTN Negative, Blue
N→TN Negative,	T→FSTN Negative, Black
L→VA Negative	D→FSTN Negative (Double film)
H→HTN Positive, Gray	F→FSTN Positive
I→HTN Negative, Black	K→FSC Negative
U→HTN Negative, Blue	S→FSC Positive
M→STN Negative, Blue	E→ISTN Negative, Black
G→STN Positive, Gray	C→CSTN Negative, Black
Y→STN Positive, Yellow Green	A→ASTN Negative, Black

⑦ LCD Polarize Type/ Temperature range/ View direction

A→Reflective, N.T, 6:00	H→Transflective, W.T, 6:00
D→Reflective, N.T, 12:00	K→Transflective, W.T, 12:00
G→Reflective, W. T, 6:00	C→Transmissive, N.T, 6:00
J→Reflective, W. T, 12:00	F→Transmissive, N.T, 12:00
B→Transflective, N.T, 6:00	I→Transmissive, W. T, 6:00
E→Transflective, N.T, 12:00	L→Transmissive, W.T, 12:00

⑧ Special Code

V: Build in Negative Voltage

#: Fit in with the ROHS Directions and regulations

N : IC NT7107, NT7108

2.Precautions in use of LCD Modules

- (1) Avoid applying excessive shocks to the module or making any alterations or modifications to it.
- (2) Don't make extra holes on the printed circuit board, modify its shape or change the components of LCD module.
- (3) Don't disassemble the LCM.
- (4) Don't operate it above the absolute maximum rating.
- (5) Don't drop, bend or twist LCM.
- (6) Soldering: only to the I/O terminals.
- (7) Storage: please storage in anti-static electricity container and clean environment.
- (8) Winstar have the right to change the passive components, including R3,R6 & backlight adjust resistors. (Resistors,capacitors and other passive components will have different appearance and color caused by the different supplier.)
- (9) Winstar have the right to change the PCB Rev. (In order to satisfy the supplying stability, management optimization and the best product performance...etc, under the premise of not affecting the electrical characteristics and external dimensions, Winstar have the right to modify the version.)
- (10) To ensure the stability of the display screen, please apply screen saver after showing 30 mins of fixed display content.
- (11) Please heat up a little the tape sticking on the components when removing it; otherwise the components might be damaged.

3.General Specification

Item	Dimension	Unit
Number of dots	128 x 64	—
Module dimension	75.0 x 52.7 x 8.9 (MAX)	mm
View area	58.8 x 31.4	mm
Active area	55.01 x 27.49	mm
Dot size	0.40 x 0.40	mm
Dot pitch	0.43 x 0.43	mm
LCD type	STN Positive, Gray Transflective (In LCD production, It will occur slightly color difference. We can only guarantee the same color in the same batch.)	
Duty	1/64	
View direction	6 o'clock	
Backlight Type	LED, Yellow Green	
IC	NT7107, NT7108	

4. Absolute Maximum Ratings

Item	Symbol	Min	Typ	Max	Unit
Operating Temperature	T_{OP}	-20	—	+70	°C
Storage Temperature	T_{ST}	-30	—	+80	°C
Supply Voltage For Logic	$V_{DD}-V_{SS}$	-0.3	—	7.0	V
Driver Supply Voltage	V_{LCD}	$V_{EE}-0.3$	—	$V_{DD}+0.3$	V

5. Electrical Characteristics

ITEM	SYMBOL	CONDITION	MIN.	TYP.	MAX.	UNIT
Supply Voltage For Logic	$V_{DD}-V_{SS}$	—	4.5	5.0	5.5	V
Supply Voltage For LCD	$V_{DD}-V_O$	$T_a=-20^{\circ}\text{C}$	—	—	9.6	V
		$T_a=25^{\circ}\text{C}$	7.8	8.0	8.2	V
*Note		$T_a=70^{\circ}\text{C}$	7.6	—	—	V
Input High Volt.	V_{IH}	—	$0.7 V_{DD}$	—	V_{DD}	V
Input Low Volt.	V_{IL}	—	0	—	0.8	V
Output High Volt.	V_{OH}	—	2.4	—	—	V
Output Low Volt.	V_{OL}	—	—	—	0.4	V
Supply Current	I_{DD}	$V_{DD}=5.0\text{V}$	3.0	4.0	5.0	mA

* Note: Please design the VOP adjustment circuit on customer's main board

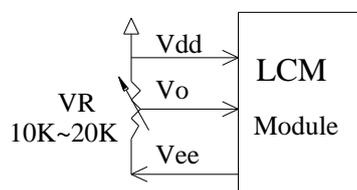

6. Optical Characteristics

Item	Symbol	Condition	Min	Typ	Max	Unit
View Angle	θ	$CR \geq 2$	0	—	20	$\phi = 180^\circ$
	θ	$CR \geq 2$	0	—	40	$\phi = 0^\circ$
	θ	$CR \geq 2$	0	—	30	$\phi = 90^\circ$
	θ	$CR \geq 2$	0	—	30	$\phi = 270^\circ$
Contrast Ratio	CR	—	—	3	—	—
Response Time	T rise	—	—	200	300	ms
	T fall	—	—	250	350	ms

Definition of Operation Voltage (Vop)

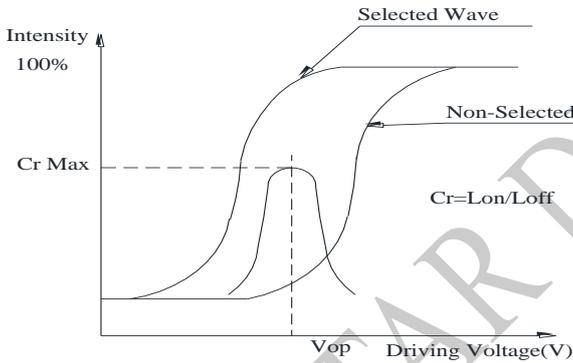
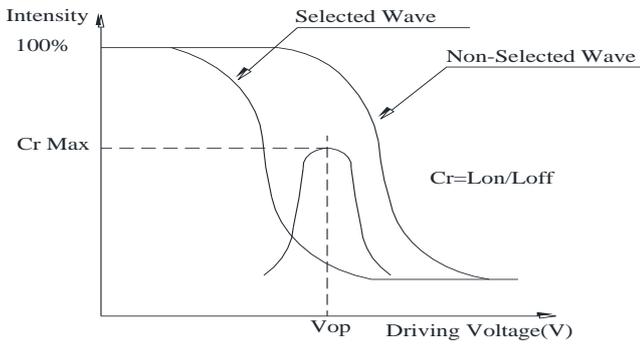

Definition of Response Time (Tr, Tf)

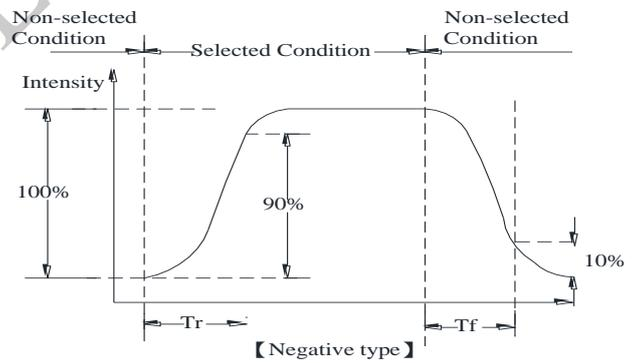
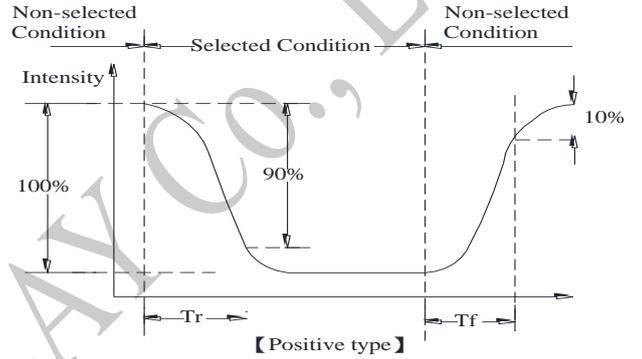

Conditions :

Operating Voltage : Vop Viewing Angle(θ , ϕ) : 0° , 0°
 Frame Frequency : 64 HZ Driving Waveform : 1/N duty , 1/a bias

Definition of viewing angle($CR \geq 2$)

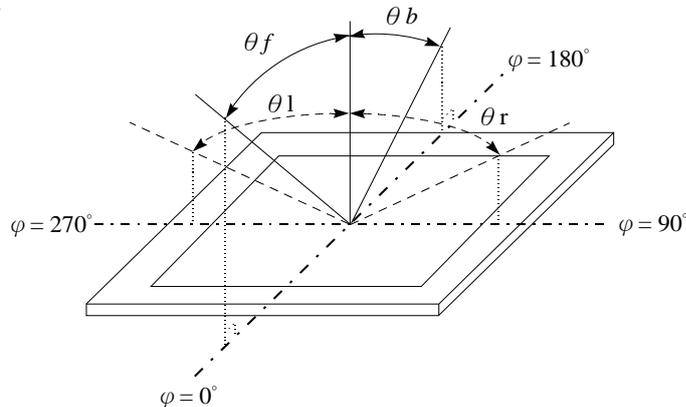

7.Interface Pin Function

Pin No.	Symbol	Level	Description
1	VDD	5.0V	Supply voltage for logic
2	V _{SS}	0V	Ground
3	V _o	(Variable)	Contrast Adjustment
4	DB0	H/L	Data bus line
5	DB1	H/L	Data bus line
6	DB2	H/L	Data bus line
7	DB3	H/L	Data bus line
8	DB4	H/L	Data bus line
9	DB5	H/L	Data bus line
10	DB6	H/L	Data bus line
11	DB7	H/L	Data bus line
12	CS1	L	Select Column 1~ Column 64
13	CS2	L	Select Column 65~ Column 128
14	/RST	L	Reset signal
15	R/W	H/L	H: Read (MPU←Module) , L: Write (MPU→Module)
16	D/I	H/L	H: Data , L : Instruction
17	E	H	Enable signal
18	V _{ee}	—	Negative Voltage output
19	A	—	Power Supply for LED backlight (+)
20	K	—	Power Supply for LED backlight (-)

8. Contour Drawing & Block Diagram

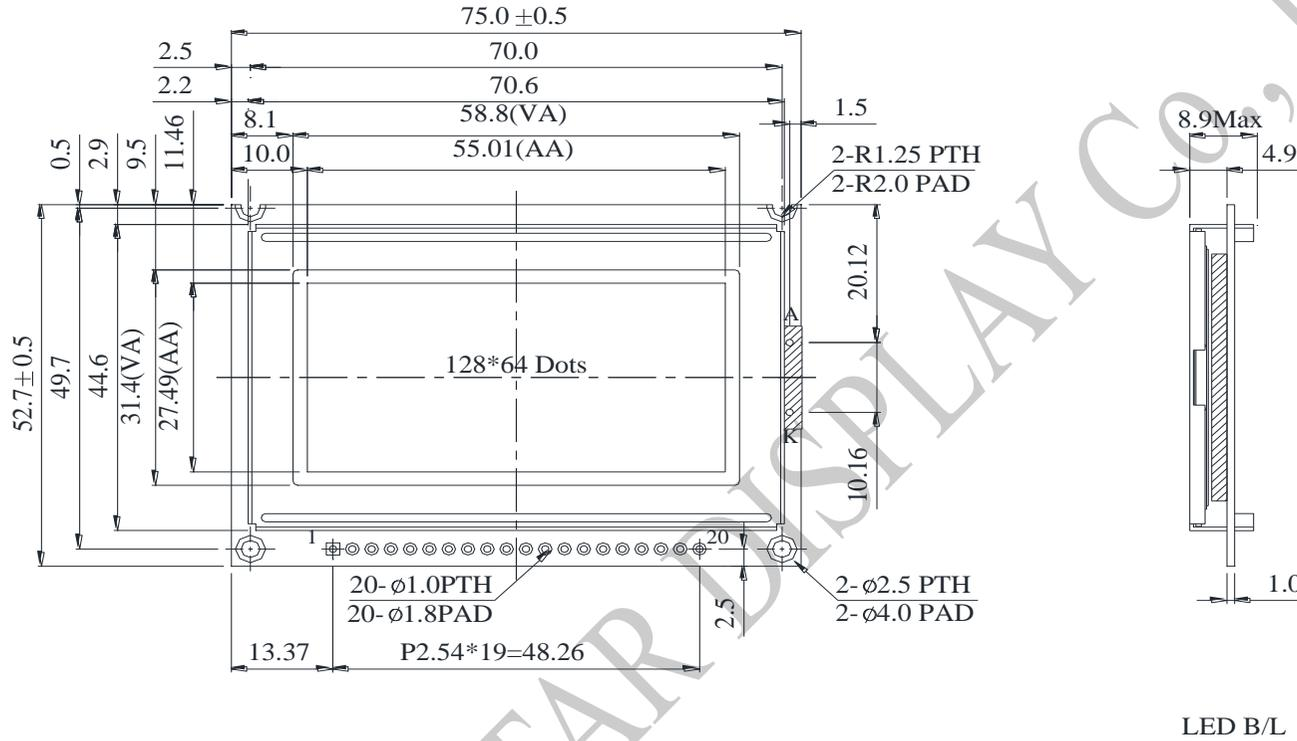

PIN NO.	SYMBOL
1	Vdd
2	Vss
3	Vo
4	DB0
5	DB1
6	DB2
7	DB3
8	DB4
9	DB5
10	DB6
11	DB7
12	CS1
13	CS2
14	RST
15	R/W
16	D/I
17	E
18	Vee
19	A
20	K

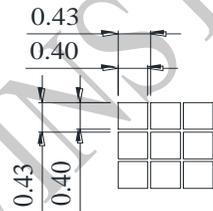

DOT SIZE
SCALE 10/1

The non-specified tolerance of dimension is ± 0.3 mm .

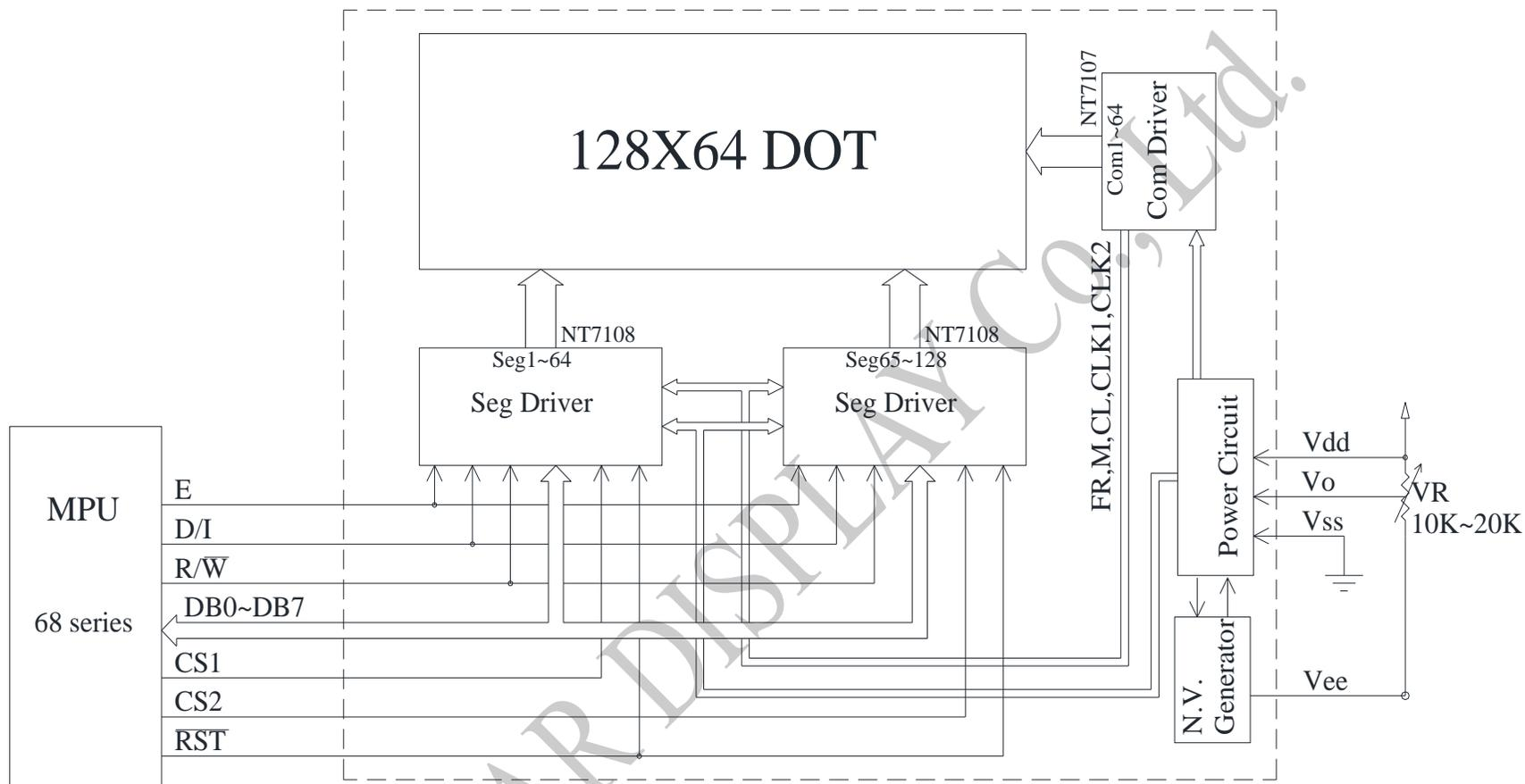

External contrast adjustment.

9. Reliability

Content of Reliability Test (Wide temperature, -20°C~70°C)

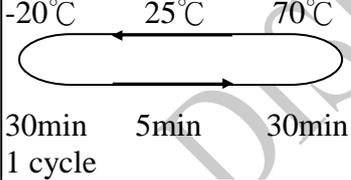
Environmental Test			
Test Item	Content of Test	Test Condition	Note
High Temperature storage	Endurance test applying the high storage temperature for a long time.	80°C 200hrs	2
Low Temperature storage	Endurance test applying the low storage temperature for a long time.	-30°C 200hrs	1,2
High Temperature Operation	Endurance test applying the electric stress (Voltage & Current) and the thermal stress to the element for a long time.	70°C 200hrs	— —
Low Temperature Operation	Endurance test applying the electric stress under low temperature for a long time.	-20°C 200hrs	1
High Temperature/Humidity storage	The module should be allowed to stand at 60°C, 90%RH max For 96hrs under no-load condition excluding the polarizer, Then taking it out and drying it at normal temperature.	60°C, 90%RH 96hrs	1,2
Thermal shock resistance	The sample should be allowed stand the following 10 cycles of operation  30min 5min 30min 1 cycle	-20°C/70°C 10 cycles	— —
Vibration test	Endurance test applying the vibration during transportation and using.	Total fixed amplitude : 1.5mm Vibration Frequency : 10~55Hz One cycle 60 seconds to 3 directions of X,Y,Z for Each 15 minutes	3
Static electricity test	Endurance test applying the electric stress to the terminal.	VS=±600V(contact), ±800v(air), RS=330Ω CS=150pF 10 times	— —

Note1: No dew condensation to be observed.

Note2: The function test shall be conducted after 4 hours storage at the normal Temperature and humidity after remove from the test chamber.

Note3: The packing have to including into the vibration testing.

10. Backlight Information

Specification

PARAMETER	SYMBOL	MIN	TYP	MAX	UNIT	TEST CONDITION
Supply Current	I _{LED}	80	100	120	mA	V=4.2V
Supply Voltage	V	3.9	4.2	4.4	V	—
Reverse Voltage	V _R	—	—	8	V	—
Luminance (Without LCD)	I _V	34	42.5	—	CD/M ²	I _{LED} =100mA
Wave Length	λ _p	569	571	574	nm	I _{LED} =100mA
Life Time	—	—	50000	—	Hr.	I _{LED} ≤ 100mA 25°C, 50-60%RH
Color	Yellow Green					

Note: The LED of B/L is drive by current only, drive voltage is for reference only. drive voltage can make driving current under safety area (current between minimum and maximum).

.Drive from pin19, pin20

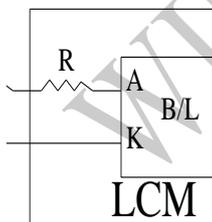

11. Inspection specification

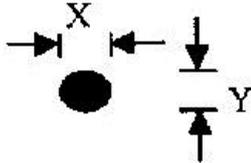
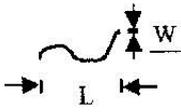
NO	Item	Criterion	AQL												
01	Electrical Testing	<p>Missing vertical, horizontal segment, segment contrast defect.</p> <p>Missing character , dot or icon.</p> <p>Display malfunction.</p> <p>No function or no display.</p> <p>Current consumption exceeds product specifications.</p> <p>LCD viewing angle defect.</p> <p>Mixed product types.</p> <p>Contrast defect.</p>	0.65												
02	Black or white spots on LCD (display only)	<p>2.1 White and black spots on display $\leq 0.25\text{mm}$, no more than three white or black spots present.</p> <p>2.2 Densely spaced: No more than two spots or lines within 3mm</p>	2.5												
03	LCD black spots, white spots, contamination (non-display)	<p>3.1 Round type : As following drawing</p> <p>$\Phi = (x + y) / 2$</p>  <table border="1" data-bbox="821 974 1348 1227"> <thead> <tr> <th>SIZE</th> <th>Acceptable Q TY</th> </tr> </thead> <tbody> <tr> <td>$\Phi \leq 0.10$</td> <td>Accept no dense</td> </tr> <tr> <td>$0.10 < \Phi \leq 0.20$</td> <td>2</td> </tr> <tr> <td>$0.20 < \Phi \leq 0.25$</td> <td>1</td> </tr> <tr> <td>$0.25 < \Phi$</td> <td>0</td> </tr> </tbody> </table>	SIZE	Acceptable Q TY	$\Phi \leq 0.10$	Accept no dense	$0.10 < \Phi \leq 0.20$	2	$0.20 < \Phi \leq 0.25$	1	$0.25 < \Phi$	0	2.5		
		SIZE	Acceptable Q TY												
$\Phi \leq 0.10$	Accept no dense														
$0.10 < \Phi \leq 0.20$	2														
$0.20 < \Phi \leq 0.25$	1														
$0.25 < \Phi$	0														
<p>3.2 Line type : (As following drawing)</p>  <table border="1" data-bbox="710 1467 1348 1720"> <thead> <tr> <th>Length</th> <th>Width</th> <th>Acceptable Q TY</th> </tr> </thead> <tbody> <tr> <td>---</td> <td>$W \leq 0.02$</td> <td>Accept no dense</td> </tr> <tr> <td>$L \leq 3.0$</td> <td>$0.02 < W \leq 0.03$</td> <td rowspan="2">2</td> </tr> <tr> <td>$L \leq 2.5$</td> <td>$0.03 < W \leq 0.05$</td> </tr> <tr> <td>---</td> <td>$0.05 < W$</td> <td>As round type</td> </tr> </tbody> </table>	Length	Width	Acceptable Q TY	---	$W \leq 0.02$	Accept no dense	$L \leq 3.0$	$0.02 < W \leq 0.03$	2	$L \leq 2.5$	$0.03 < W \leq 0.05$	---	$0.05 < W$	As round type	2.5
Length	Width	Acceptable Q TY													
---	$W \leq 0.02$	Accept no dense													
$L \leq 3.0$	$0.02 < W \leq 0.03$	2													
$L \leq 2.5$	$0.03 < W \leq 0.05$														
---	$0.05 < W$	As round type													

04	Polarizer bubbles	If bubbles are visible, judge using black spot specifications, not easy to find, must check in specify direction.	Size Φ	Acceptable Q TY	2.5
			$\Phi \leq 0.20$	Accept no dense	
			$0.20 < \Phi \leq 0.50$	3	
			$0.50 < \Phi \leq 1.00$	2	
			$1.00 < \Phi$	0	
			Total Q TY	3	

WINSTAR DISPLAY Co., Ltd.

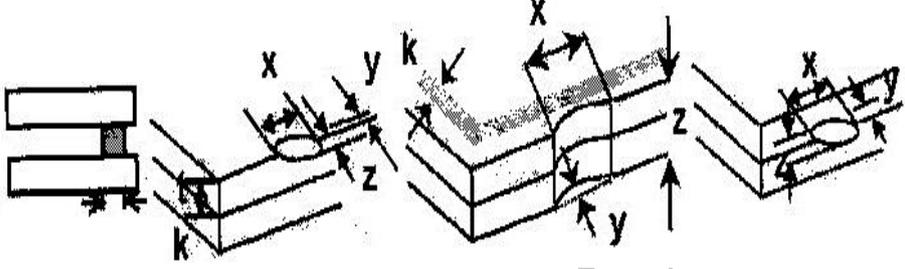
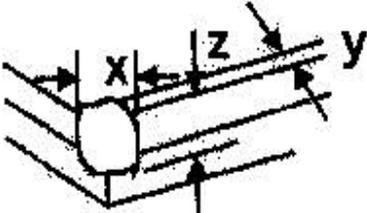
NO	Item	Criterion	AQL																		
05	Scratches	Follow NO.3 LCD black spots, white spots, contamination																			
06	Chipped glass	<p>Symbols Define: x: Chip length y: Chip width z: Chip thickness k: Seal width t: Glass thickness a: LCD side length L: Electrode pad length:</p> <p>6.1 General glass chip : 6.1.1 Chip on panel surface and crack between panels:</p>  <table border="1" data-bbox="459 913 1369 1124"> <thead> <tr> <th>z: Chip thickness</th> <th>y: Chip width</th> <th>x: Chip length</th> </tr> </thead> <tbody> <tr> <td>$Z \leq 1/2t$</td> <td>Not over viewing area</td> <td>$x \leq 1/8a$</td> </tr> <tr> <td>$1/2t < z \leq 2t$</td> <td>Not exceed 1/3k</td> <td>$x \leq 1/8a$</td> </tr> </tbody> </table> <p>⊙If there are 2 or more chips, x is total length of each chip.</p> <p>6.1.2 Corner crack:</p>  <table border="1" data-bbox="459 1556 1369 1767"> <thead> <tr> <th>z: Chip thickness</th> <th>y: Chip width</th> <th>x: Chip length</th> </tr> </thead> <tbody> <tr> <td>$Z \leq 1/2t$</td> <td>Not over viewing area</td> <td>$x \leq 1/8a$</td> </tr> <tr> <td>$1/2t < z \leq 2t$</td> <td>Not exceed 1/3k</td> <td>$x \leq 1/8a$</td> </tr> </tbody> </table> <p>⊙If there are 2 or more chips, x is the total length of each chip.</p>	z: Chip thickness	y: Chip width	x: Chip length	$Z \leq 1/2t$	Not over viewing area	$x \leq 1/8a$	$1/2t < z \leq 2t$	Not exceed 1/3k	$x \leq 1/8a$	z: Chip thickness	y: Chip width	x: Chip length	$Z \leq 1/2t$	Not over viewing area	$x \leq 1/8a$	$1/2t < z \leq 2t$	Not exceed 1/3k	$x \leq 1/8a$	2.5
z: Chip thickness	y: Chip width	x: Chip length																			
$Z \leq 1/2t$	Not over viewing area	$x \leq 1/8a$																			
$1/2t < z \leq 2t$	Not exceed 1/3k	$x \leq 1/8a$																			
z: Chip thickness	y: Chip width	x: Chip length																			
$Z \leq 1/2t$	Not over viewing area	$x \leq 1/8a$																			
$1/2t < z \leq 2t$	Not exceed 1/3k	$x \leq 1/8a$																			

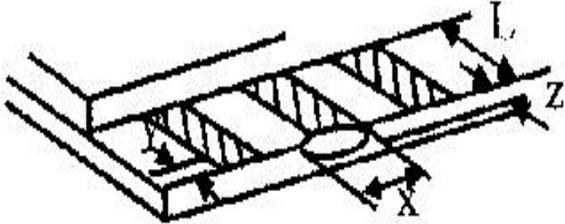
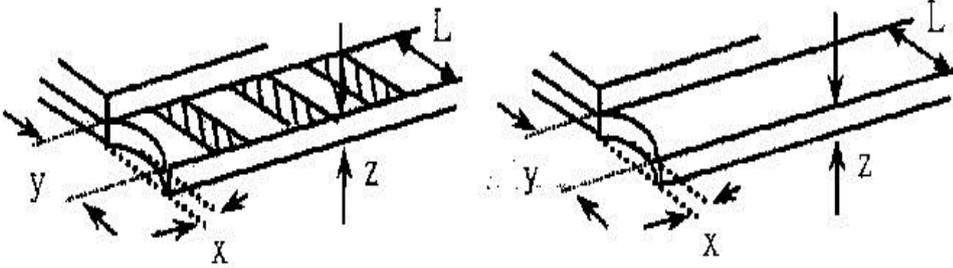
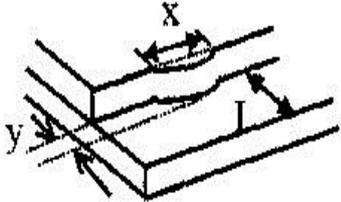
NO	Item	Criterion	AQL																
06	Glass crack	<p>Symbols :</p> <p>x: Chip length y: Chip width z: Chip thickness k: Seal width t: Glass thickness a: LCD side length</p> <p>L: Electrode pad length</p> <p>6.2 Protrusion over terminal :</p> <p>6.2.1 Chip on electrode pad :</p>  <table border="1" data-bbox="368 792 1289 893"> <tr> <td>y: Chip width</td> <td>x: Chip length</td> <td>z: Chip thickness</td> </tr> <tr> <td>$y \leq 0.5\text{mm}$</td> <td>$x \leq 1/8a$</td> <td>$0 < z \leq t$</td> </tr> </table> <p>6.2.2 Non-conductive portion:</p>  <table border="1" data-bbox="437 1274 1267 1391"> <tr> <td>y: Chip width</td> <td>x: Chip length</td> <td>z: Chip thickness</td> </tr> <tr> <td>$y \leq L$</td> <td>$x \leq 1/8a$</td> <td>$0 < z \leq t$</td> </tr> </table> <p>⊙ If the chipped area touches the ITO terminal, over 2/3 of the ITO must remain and be inspected according to electrode terminal specifications.</p> <p>⊙ If the product will be heat sealed by the customer, the alignment mark not be damaged.</p> <p>6.2.3 Substrate protuberance and internal crack.</p>  <table border="1" data-bbox="775 1644 1339 1744"> <tr> <td>y: width</td> <td>x: length</td> </tr> <tr> <td>$y \leq 1/3L$</td> <td>$x \leq a$</td> </tr> </table>	y: Chip width	x: Chip length	z: Chip thickness	$y \leq 0.5\text{mm}$	$x \leq 1/8a$	$0 < z \leq t$	y: Chip width	x: Chip length	z: Chip thickness	$y \leq L$	$x \leq 1/8a$	$0 < z \leq t$	y: width	x: length	$y \leq 1/3L$	$x \leq a$	2.5
y: Chip width	x: Chip length	z: Chip thickness																	
$y \leq 0.5\text{mm}$	$x \leq 1/8a$	$0 < z \leq t$																	
y: Chip width	x: Chip length	z: Chip thickness																	
$y \leq L$	$x \leq 1/8a$	$0 < z \leq t$																	
y: width	x: length																		
$y \leq 1/3L$	$x \leq a$																		

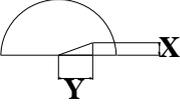
NO	Item	Criterion	AQL
07	Cracked glass	The LCD with extensive crack is not acceptable.	2.5
08	Backlight elements	8.1 Illumination source flickers when lit. 8.2 Spots or scratched that appear when lit must be judged. Using LCD spot, lines and contamination standards. 8.3 Backlight doesn't light or color wrong.	0.65 2.5 0.65
09	Bezel	9.1 Bezel may not have rust, be deformed or have fingerprints, stains or other contamination. 9.2 Bezel must comply with job specifications.	2.5 0.65
10	PCB、COB	10.1 COB seal may not have pinholes larger than 0.2mm or contamination. 10.2 COB seal surface may not have pinholes through to the IC. 10.3 The height of the COB should not exceed the height indicated in the assembly diagram. 10.4 There may not be more than 2mm of sealant outside the seal area on the PCB. And there should be no more than three places. 10.5 No oxidation or contamination PCB terminals. 10.6 Parts on PCB must be the same as on the production characteristic chart. There should be no wrong parts, missing parts or excess parts. 10.7 The jumper on the PCB should conform to the product characteristic chart. 10.8 If solder gets on bezel tab pads, LED pad, zebra pad or screw hold pad, make sure it is smoothed down. 10.9 The Scraping testing standard for Copper Coating of PCB  $X * Y \leq 2\text{mm}^2$	2.5 2.5 0.65 2.5 2.5 0.65 0.65 2.5 2.5
11	Soldering	11.1 No un-melted solder paste may be present on the PCB. 11.2 No cold solder joints, missing solder connections, oxidation or icicle. 11.3 No residue or solder balls on PCB. 11.4 No short circuits in components on PCB.	2.5 2.5 2.5 0.65

NO	Item	Criterion	AQL
12	General appearance	12.1 No oxidation, contamination, curves or, bends on interface Pin (OLB) of TCP.	2.5
		12.2 No cracks on interface pin (OLB) of TCP.	0.65
		12.3 No contamination, solder residue or solder balls on product.	2.5
		12.4 The IC on the TCP may not be damaged, circuits.	2.5
		12.5 The uppermost edge of the protective strip on the interface pin must be present or look as if it cause the interface pin to sever.	2.5
		12.6 The residual rosin or tin oil of soldering (component or chip component) is not burned into brown or black color.	2.5
		12.7 Sealant on top of the ITO circuit has not hardened.	2.5
		12.8 Pin type must match type in specification sheet.	0.65
		12.9 LCD pin loose or missing pins.	0.65
		12.10 Product packaging must the same as specified on packaging specification sheet.	0.65
		12.11 Product dimension and structure must conform to product specification sheet.	0.65
		12.12 Visual defect outside of VA is not considered to be rejection.	0.65

12. Material List of Components for RoHs

1. WINSTAR Display Co., Ltd hereby declares that all of or part of products (with the mark “#”in code), including, but not limited to, the LCM, accessories or packages, manufactured and/or delivered to your company (including your subsidiaries and affiliated company) directly or indirectly by our company (including our subsidiaries or affiliated companies) do not intentionally contain any of the substances listed in all applicable EU directives and regulations, including the following substances.

Exhibit A : The Harmful Material List

Material	Cd	Pb	Hg	Cr6+	PBB	PBDE	DEHP	BBP	DBP	DIBP
Limited Value	100 ppm	1000 ppm	1000 ppm	1000 ppm	1000 ppm	1000 ppm	1000 ppm	1000 ppm	1000 ppm	1000 ppm
Above limited value is set up according to RoHS.										

2. Process for RoHS requirement : **(only for RoHS inspection)**

- (1) Use the Sn/Ag/Cu soldering surface ; the surface of Pb-free solder is rougher than we used before.
- (2) Heat-resistance temp. :
 - Reflow : 250°C, 30 seconds Max. ;
 - Connector soldering wave or hand soldering : 320°C, 10 seconds max.
- (3) Temp. curve of reflow, max. Temp. : 235±5°C ;
 - Recommended customer’s soldering temp. of connector : 280°C, 3 seconds.

13.Recommendable Storage

1. Place the panel or module in the temperature $25^{\circ}\text{C}\pm 5^{\circ}\text{C}$ and the humidity below 65% RH
2. Do not place the module near organics solvents or corrosive gases.
3. Do not crush, shake, or jolt the module.

WINSTAR DISPLAY Co., Ltd.



1、Panel Specification :

- 1. Panel Type : Pass NG , _____
- 2. View Direction : Pass NG , _____
- 3. Numbers of Dots : Pass NG , _____
- 4. View Area : Pass NG , _____
- 5. Active Area : Pass NG , _____
- 6. Operating Temperature : Pass NG , _____
- 7. Storage Temperature : Pass NG , _____
- 8. Others : _____

2、Mechanical Specification :

- 1. PCB Size : Pass NG , _____
- 2. Frame Size : Pass NG , _____
- 3. Material of Frame : Pass NG , _____
- 4. Connector Position : Pass NG , _____
- 5. Fix Hole Position : Pass NG , _____
- 6. Backlight Position : Pass NG , _____
- 7. Thickness of PCB : Pass NG , _____
- 8. Height of Frame to PCB : Pass NG , _____
- 9. Height of Module : Pass NG , _____
- 10. Others : Pass NG , _____

3、Relative Hole Size :

- 1. Pitch of Connector : Pass NG , _____
- 2. Hole size of Connector : Pass NG , _____
- 3. Mounting Hole size : Pass NG , _____
- 4. Mounting Hole Type : Pass NG , _____
- 5. Others : Pass NG , _____

4、Backlight Specification :

- 1. B/L Type : Pass NG , _____
- 2. B/L Color : Pass NG , _____
- 3. B/L Driving Voltage (Reference for LED Type) : Pass NG , _____
- 4. B/L Driving Current : Pass NG , _____
- 5. Brightness of B/L : Pass NG , _____
- 6. B/L Solder Method : Pass NG , _____
- 7. Others : Pass NG , _____

>> Go to page 2 <<



Module Number : _____

5、Electronic Characteristics of Module :

- | | | |
|------------------------------|-------------------------------|-------------------------------------|
| 1. Input Voltage : | <input type="checkbox"/> Pass | <input type="checkbox"/> NG , _____ |
| 2. Supply Current : | <input type="checkbox"/> Pass | <input type="checkbox"/> NG , _____ |
| 3. Driving Voltage for LCD : | <input type="checkbox"/> Pass | <input type="checkbox"/> NG , _____ |
| 4. Contrast for LCD : | <input type="checkbox"/> Pass | <input type="checkbox"/> NG , _____ |
| 5. B/L Driving Method : | <input type="checkbox"/> Pass | <input type="checkbox"/> NG , _____ |
| 6. Negative Voltage Output : | <input type="checkbox"/> Pass | <input type="checkbox"/> NG , _____ |
| 7. Interface Function : | <input type="checkbox"/> Pass | <input type="checkbox"/> NG , _____ |
| 8. LCD Uniformity : | <input type="checkbox"/> Pass | <input type="checkbox"/> NG , _____ |
| 9. ESD test : | <input type="checkbox"/> Pass | <input type="checkbox"/> NG , _____ |
| 10. Others : | <input type="checkbox"/> Pass | <input type="checkbox"/> NG , _____ |

6、Summary :

WINSTAR DISPLAY CO., Ltd.

Sales signature : _____

Customer Signature : _____

Date : / /