



ORIENT

Photocoupler

Product Data Sheet

Name: ORPC-827

Customer: _____

Date: _____

SHENZHEN ORIENT COMPONENTS CO., LTD

Block A 3rd Floor No.4 Building, Tian'an Cyber Park, Huangge Rd, LongGang Dist, Shenzhen, GD

TEL: 0755-29681816

FAX: 0755-29681200

www.orient-opto.com

1. Features

- (1). Current conversion ratio (Min 50% Working condition $I_F=5mA$, $V_{CE}=5V$)
- (2). Insulation Voltage = 5,000Vrms,
- (3). Response Time
(tr: TYP. 4 μ s; tf: TYP. 5 μ s at $V_{CE}=2V$, $I_c=2mA$, $R_L=100 \Omega$)
- (4). ORPC-827: 2-channel type
ORPC-827M: 2-channel type
ORPC-827S: 2-channel type
- (5). UL approved(No.E323844)
VDE approved (No.40029733)
CQC approved (No.CQC09001029446 CQC13001086898)
CE approved (No.AC/0431008)
State Grid approved (No.SGCM013420170152)

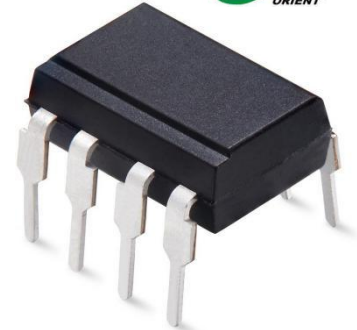

Pin No. and Internal connection diagram

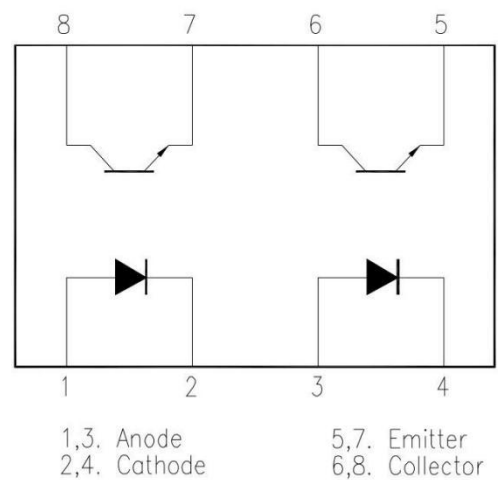

2. Instructions

- (1). ORPC-827 series optical coupler consists of two GaAs transmitting tubes and two NPN transistors
- (2). Pin pitch of ORPC-827 is 2.54mm

3. Application Range

- (1). Switching power supply
- (2). Ammeter
- (3). Computer
- (4). Instrumental application, measurement machine
- (5). Imbursement equipments, duplicating machine, automat
- (6). Family-use electric equipments, such as fans
- (7). Signal transforming systems

4、Absolute Maximum Ratings (Ta=25°C)

Parameter		Symbol	Rated Value	Unit
Input	Forward Current	I_F	60	mA
	Peak forward current(1us pulse)	I_{FP}	1	A
	Reverse Voltage	V_R	6	V
	Consume Power	P	70	mW
Output	Collector and emitter Voltage	V_{CEO}	80	V
	Emitter and collector Voltage	V_{ECO}	6	
	Collector Current	I_C	50	mA
	Consume Power	P_C	150	mW
Total Consume Power		P_{tot}	200	mW
*1 Insulation Voltage		V_{iso}	5,000	Vrms
Max Insulation Voltage (Insulating oil test)		V_{IOTM}	10,000	V
Rated Impulse Insulation Voltage		V_{IORM}	630	V
Working Temperature		T_{opr}	-55 to + 110	°C
Deposit Temperature		T_{stg}	-55 to + 125	
*2 Soldering Temperature		T_{sol}	260	

*1. AC Test, 1 minute, humidity = 40~60%

Isolation voltage shall be measured using the following method.

(1) Short between anode and cathode on the primary side and between collector and emitter on the secondary side.

(2) The isolation voltage tester with zero-cross circuit shall be used.

(3) The waveform of applied voltage shall be a sine wave.

*2. soldering time is 10 seconds

5、Electrical optical characteristics at TA=25°C

Parameter		Symbol	Condition	Min	Typ.*	Max	Unit
Input	Forward Current	V_F	$I_F=20\text{mA}$	---	1.2	1.4	V
	Reverse Voltage	I_R	$V_R=4\text{V}$	---	---	10	μA
	Collector capacitance	C_t	$V=0, f=1\text{KHz}$	---	30	250	pF
Output	Collector to emitter Current	I_{CEO}	$V_{CE}=20\text{V}, I_F=0\text{mA}$	---	---	100	nA
	Collector and Emitter attenuation Voltage	BV_{CEO}	$I_C=0.1\text{mA}, I_F=0\text{mA}$	80	---	---	V
	Emitter and Collector attenuation Voltage	BV_{ECO}	$I_E=0.1\text{mA}, I_F=0\text{mA}$	6	---	---	V
Transforming Characteristics	*1Current conversion ratio	CTR	$I_F=5\text{mA}, V_{CE}=5\text{V}$	50	---	600	%
	Collector Current	I_C		2.5	---	50	mA
	Collector and Emitter Saturation Voltage	$V_{CE(sat)}$	$I_F=20\text{mA}, I_C=1\text{mA}$	---	0.1	0.2	V
	Insulation Impedance	R_{iso}	DC500V 40~60%R.H.	---	1×10^{12}	---	Ω
	capacitance	C_f	$V=0, f=1\text{MHz}$	---	0.6	1.0	pF
	Transforming Frequency	f_c	$V_{CE}=5\text{V}, I_C=2\text{mA}, R_L=100\Omega, -3\text{dB}$	---	80	---	kHz
	Risetime	t_r	$V_{CE}=2\text{V}, I_C=2\text{mA}, R_L=100\Omega$	---	4	18	μs
	Descend Time	t_f		---	3	18	μs

*1 Current Conversion Ratio = $I_C / I_F \times 100\%$

6、Rank table of current transfer ratio (CTR)

	CTR Rank	Min (%)	Max (%)	Condition
ORPC-827	NO BIN	50	600	$I_F=5\text{mA}, V_{CE}=5\text{V}, T_a=25^\circ\text{C}$
	A	80	160	
	B	130	260	
	C	200	400	
	D	300	600	
	BC	130	400	
	CD	200	600	

7、 Naming Rule

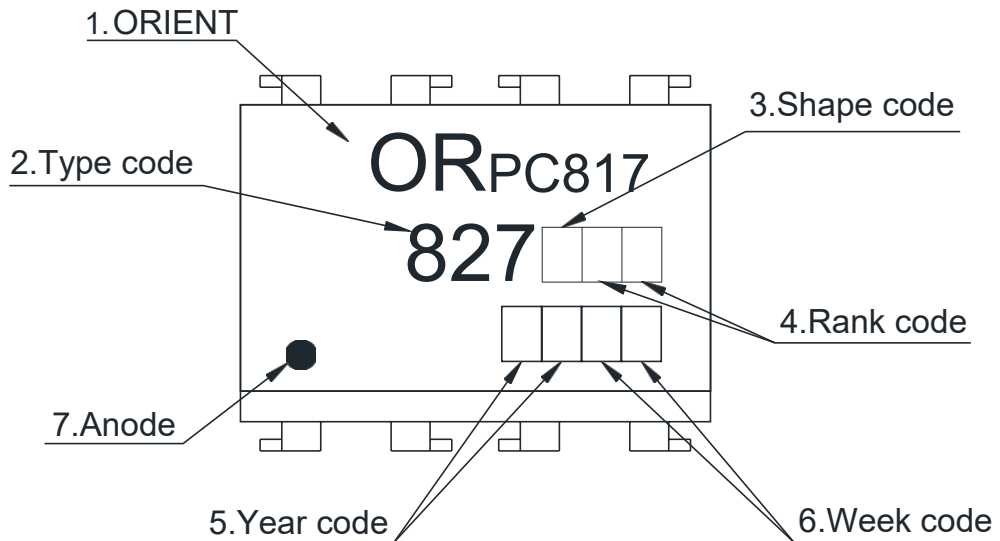

(1) ORIENT

(2) denotes Type Code.

(3) denotes Shape Code.

(4) denotes Rank code..

(5) denotes Year Code

(6) denotes Week Code

(7) Anode

8、Outer Dimension (Unit: mm)

1. ORPC-827

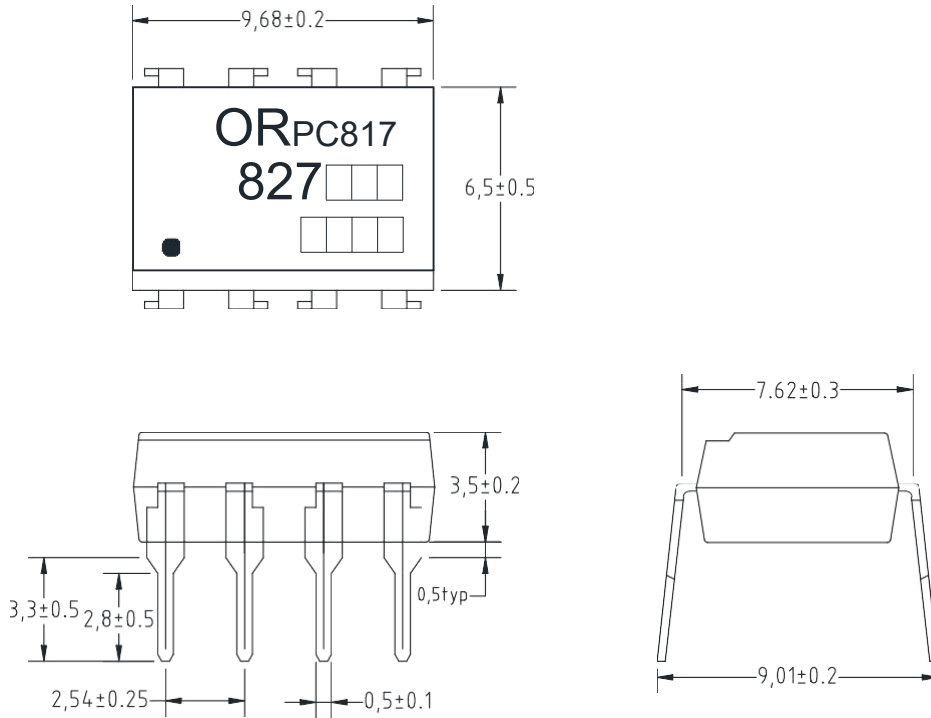

2. ORPC-827M

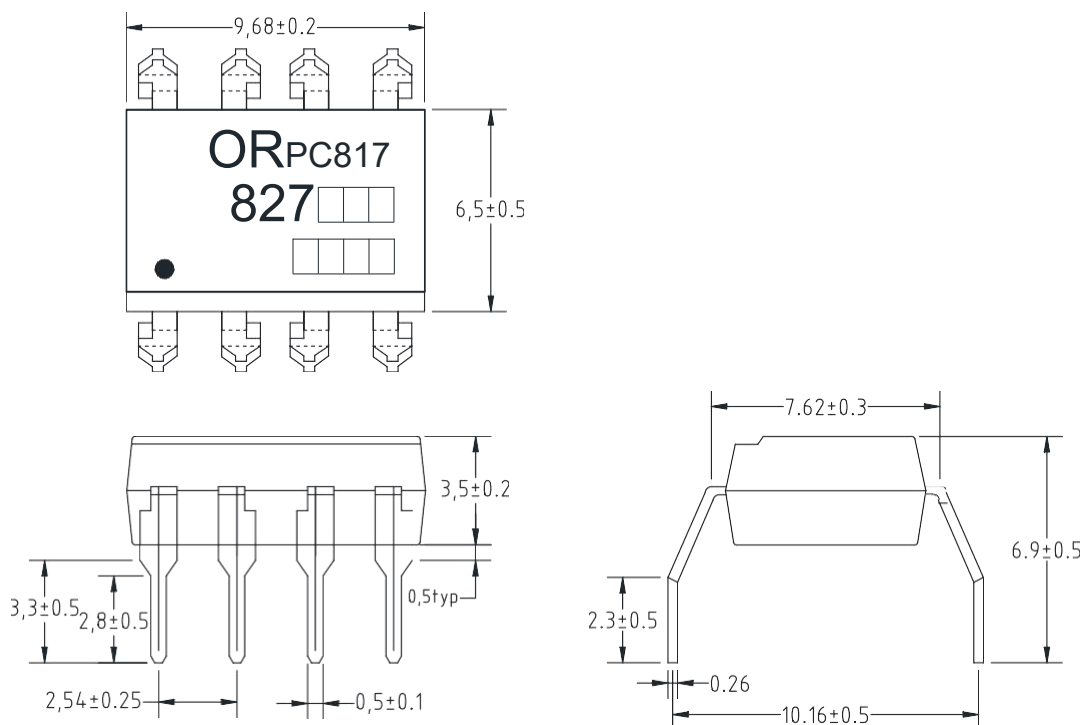

3. ORPC-827S

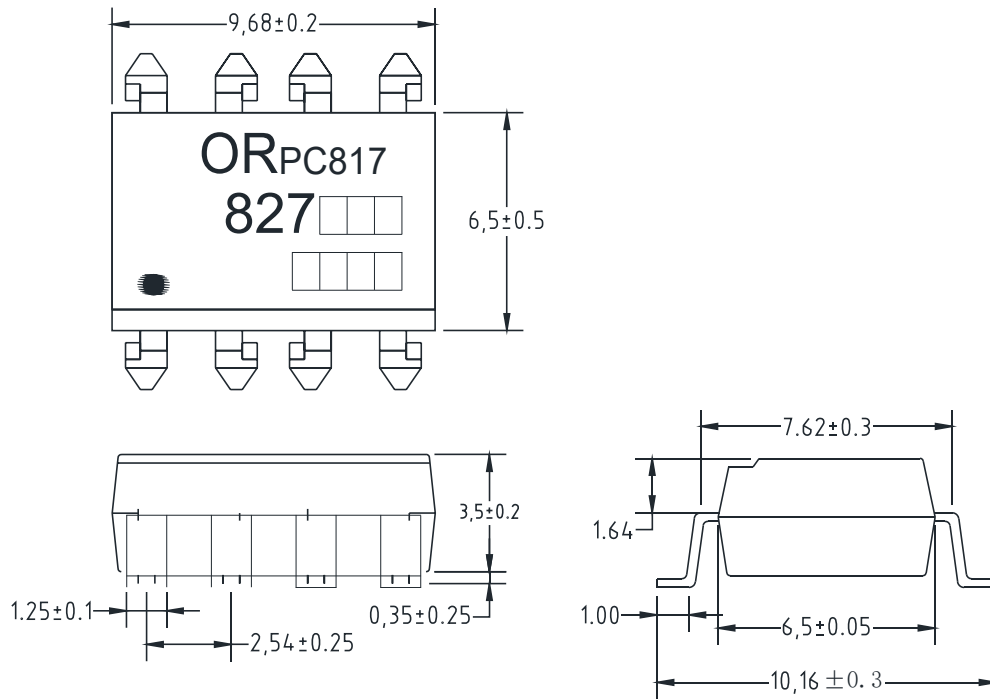

9. RECOMMENDED FOOT PRINT PATTERNS (MOUNT PAD)

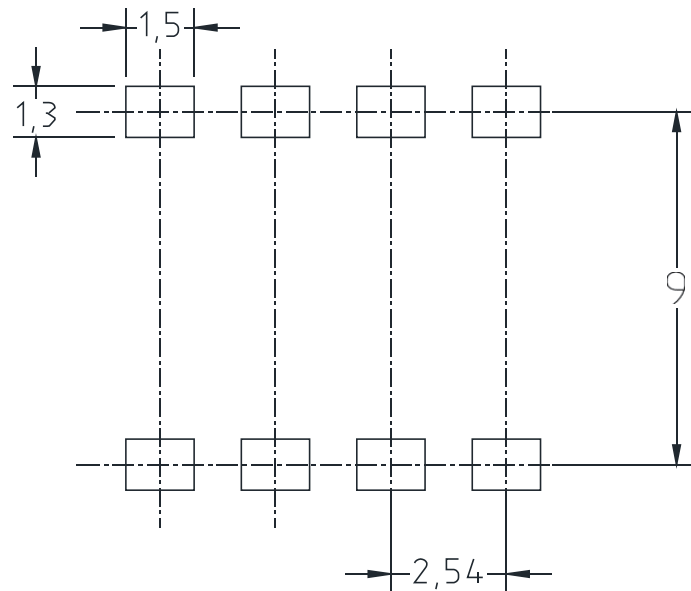

Unit: mm

10、Taping Dimensions

(1) ORPC-827-TA

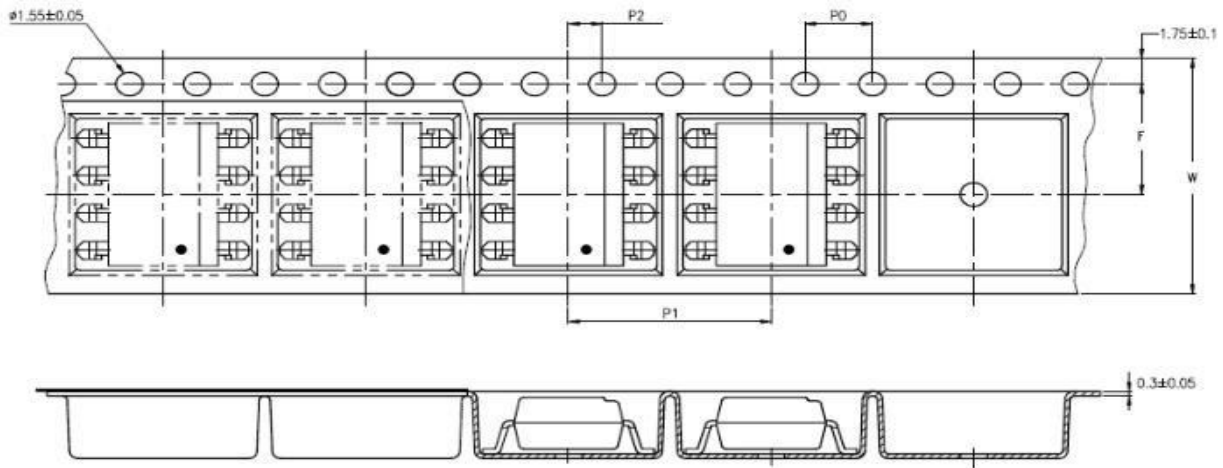

(2) ORPC-827-TA1

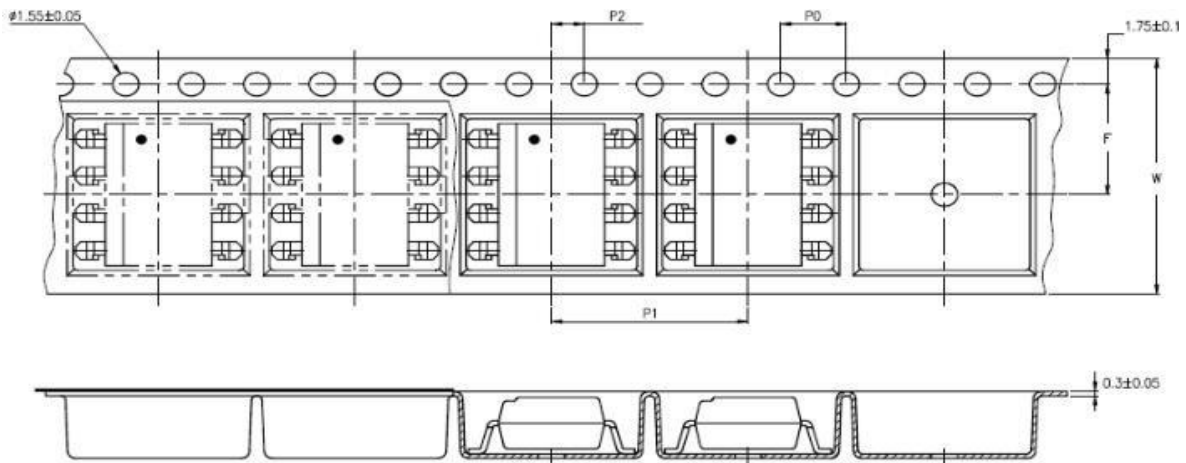

Description	Symbol	Dimension in mm(inch)
Tape wide	W	16±0.3(0.63)
Pitch of sprocket holes	P0	4±0.1(0.15)
Distance of compartment	F	7.5±0.1(0.295)
	P2	2±0.1(0.079)
Distance of compartment to compartment	P1	12±0.1(0.472)

Package Type	ORPC-827 series
Quantities(pcs)	1000

11 、 Temperature Profile Of Soldering

(1) IR Reflow soldering (JEDEC-STD-020C compliant)

One time soldering reflow is recommended within the condition of temperature and time profile shown below. Do not solder more than three times.

Profile item	Conditions
Preheat	
- Temperature Min (T Smin)	150°C
- Temperature Max (T Smax)	200°C
- Time (min to max) (ts)	90±30 sec
Soldering zone	
- Temperature (TL)	217°C
- Time (t L)	60 sec
Peak Temperature	260°C
Ramp-up rate	3°C / sec max.
3°C / sec max.	3~6°C / sec

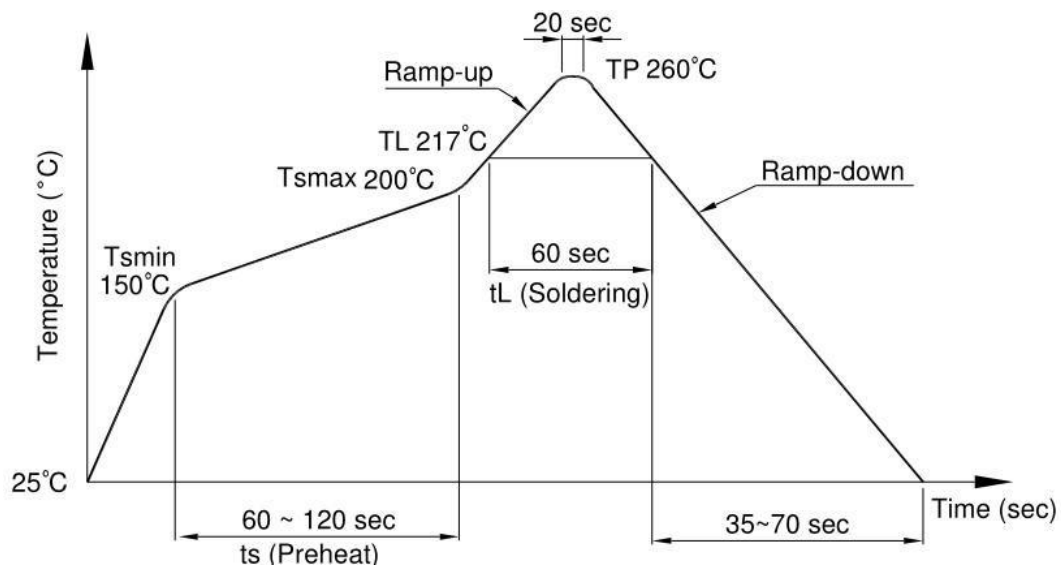

(2) Wave soldering (JEDEC22A111 compliant)

One time soldering is recommended within the condition of temperature.

Temperature	260+0/-5°C
Time	10 sec
Preheat temperature	5 to 140°C
Preheat time	30 to 80 sec

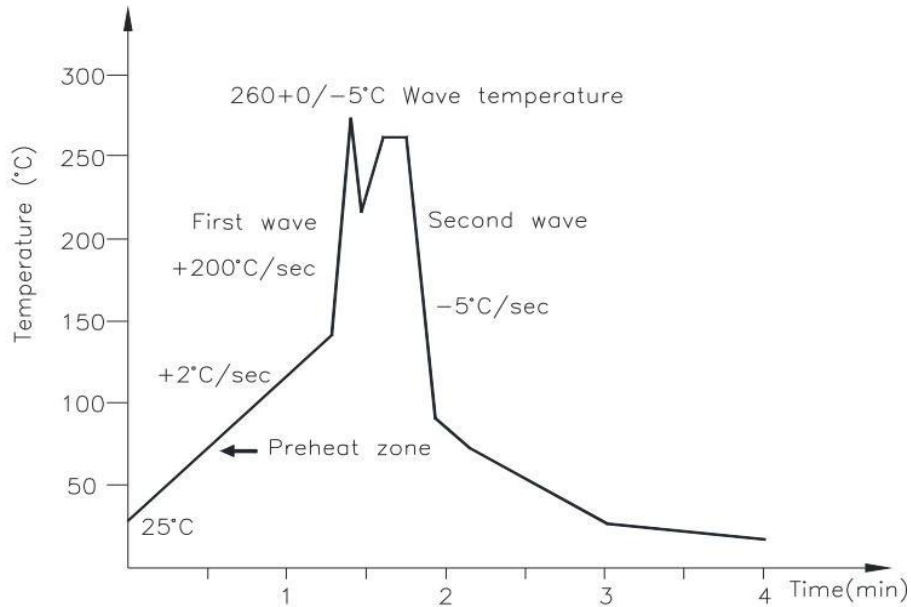

(3) Hand soldering by soldering iron

Allow single lead soldering in every single process. One time soldering is recommended.

Temperature	380+0/-5°C
Time	3 sec max

12、Characteristics Curve

Fig.1 Forward Current vs. Ambient Temperature

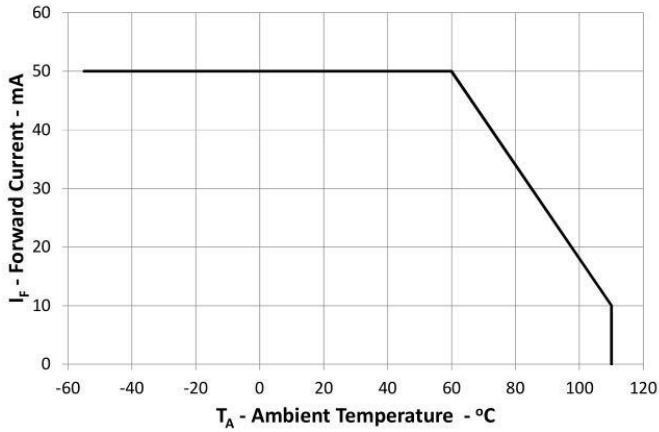

Fig.2 Collector Power Dissipation vs. Ambient Temperature

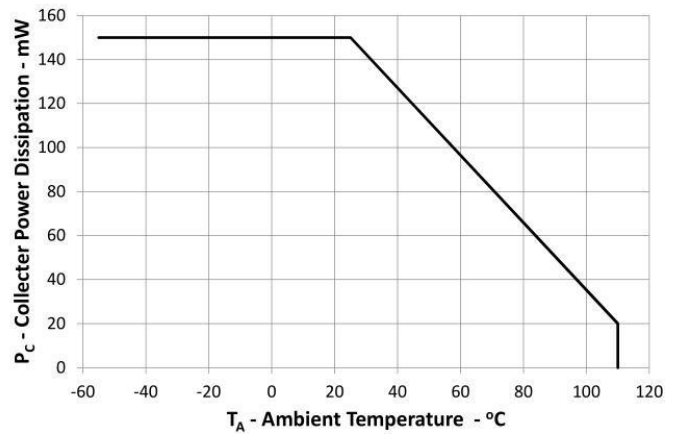

Fig.3 Collector-emitter Saturation Voltage vs. Forward Current

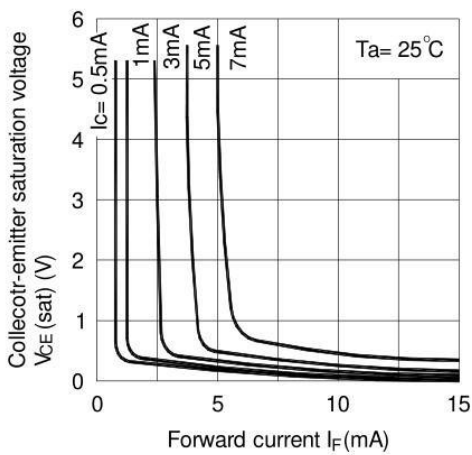

Fig.4 Forward Current vs. Forward Voltage

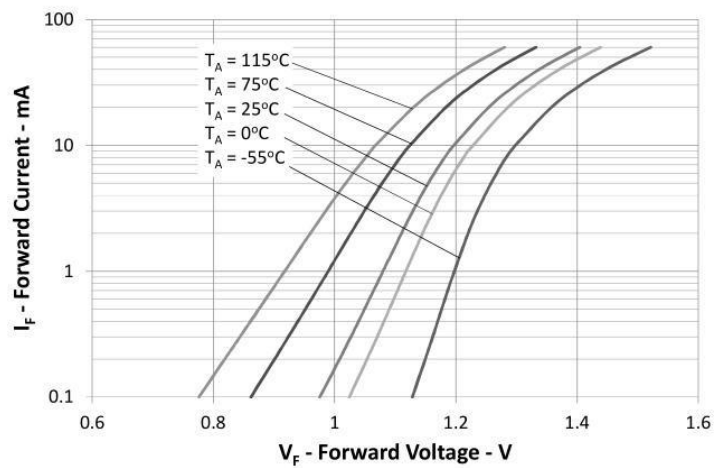

Fig.5 Current Transfer Ratio vs. Forward Current

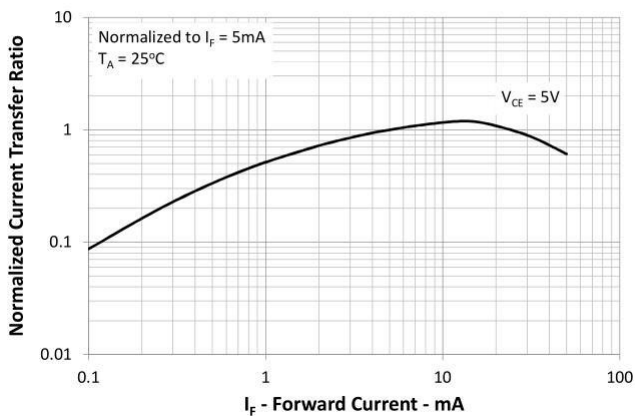

Fig.6 Collector Current vs. Collector-emitter Voltage

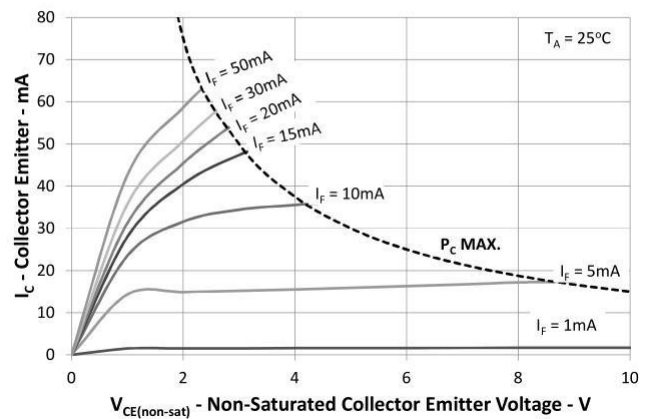

Fig.7 Relative Current Transfer Ratio vs. Ambient Temperature

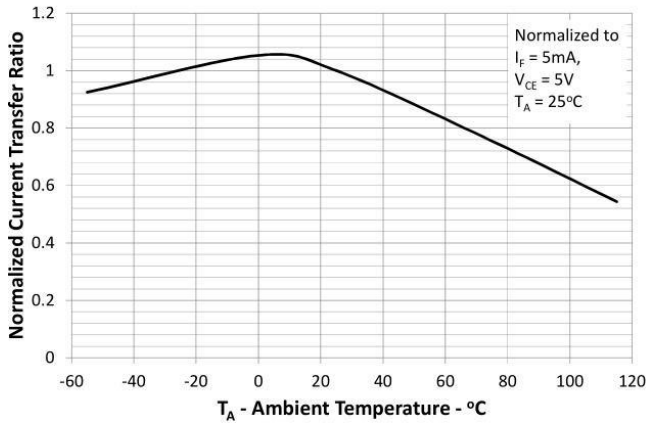

Fig.8 Collector-emitter Saturation Voltage vs. Ambient Temperature

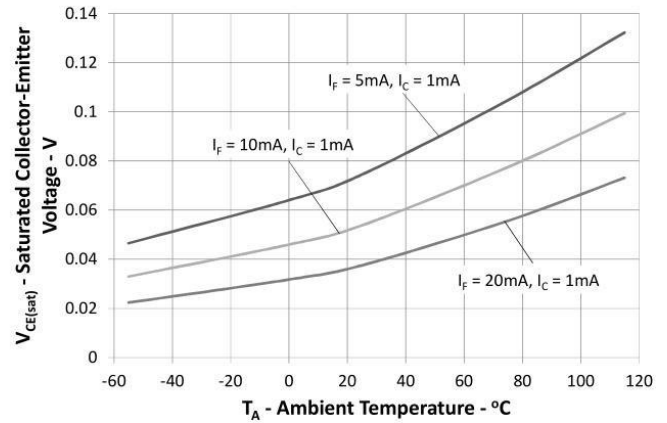

Fig.9 Collector Dark Current vs. Ambient Temperature

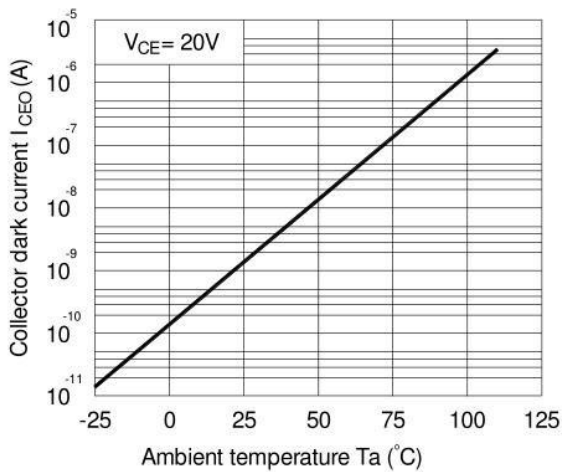

Fig.10 Response Time vs. Load Resistance

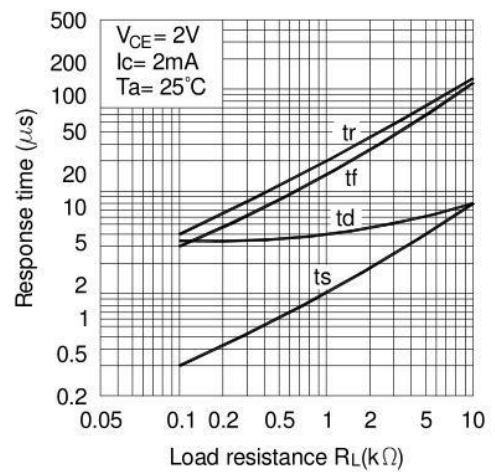
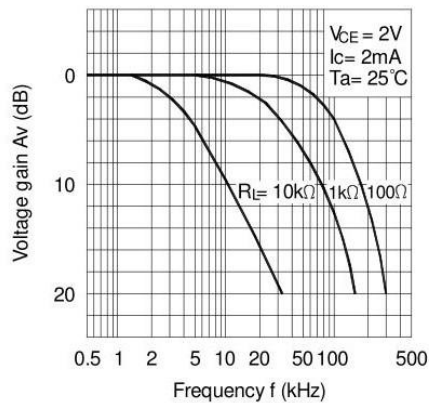
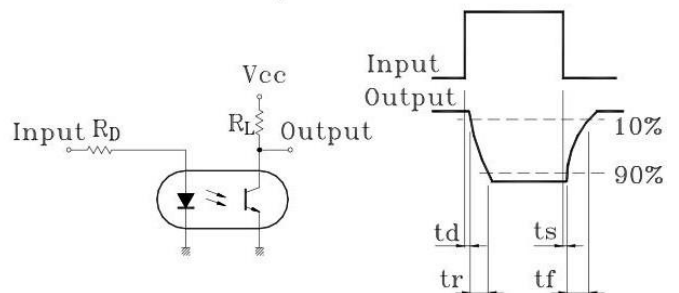

Fig.11 Frequency Response



Test Circuit for Response Time



Test Circuit for Frequency Response

