

2W isolated DC-DC converter
Fixed input voltage, unregulated dual/ single output

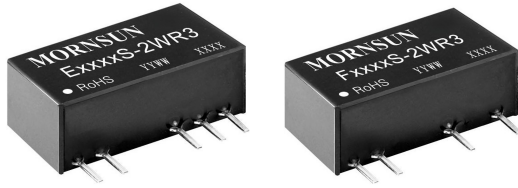

Continuous Short
Circuit Protection



Patent Protection

CE Report
EN 62368-1

UK
CA Report
BS EN 62368-1

CB RoHS
IEC 62368-1

FEATURES

- Continuous short-circuit protection
- No-load input current as low as 8mA
- Operating ambient temperature range: -40°C to +105°C
- High efficiency up to 86%
- High power density
- I/O isolation test voltage 3k VDC
- Industry standard pin-out

E_S-2WR3 & F_S-2WR3 series are specially designed for applications where an (two) isolated voltage is required in a distributed power supply system. They are suitable for occasions of:

1. The voltage of the input power supply is relatively stable with a variation of $\pm 10\%V_{in}$ or less;
2. A high input to output isolation voltage of $\leq 3000V_{DC}$ is necessary;
3. The requirement for a tight output regulation and low ripple & noise is not as strict.

Selection Guide

Certification	Part No.	Input Voltage (VDC)	Output		Full Load Efficiency (%) Min./Typ.	Capacitive Load*(μ F) Max.
		Nominal (Range)	Voltage (VDC)	Current (mA) Max./Min.		
-	E0503S-2WR3	5 (4.5-5.5)	± 3.3	$\pm 303/\pm 30$	71/75	1200
	E0505S-2WR3		± 5	$\pm 200/\pm 20$	80/84	1200
	E0509S-2WR3		± 9	$\pm 111/\pm 11$	81/85	470
	E0512S-2WR3		± 12	$\pm 83/\pm 8$	81/85	220
	E0515S-2WR3		± 15	$\pm 67/\pm 7$	82/86	220
	E0524S-2WR3		± 24	$\pm 42/\pm 4$	82/86	100
	F0503S-2WR3		3.3	400/40	74/78	2400
	F0505S-2WR3		5	400/40	80/84	2400
	F0507S-2WR3		7.2	278/28	80/84	1000
	F0509S-2WR3		9	222/22	81/85	1000
	F0512S-2WR3		12	167/17	81/85	560
	F0515S-2WR3		15	133/13	82/86	560
	F0524S-2WR3		24	83/8	82/86	220
	EN/BS EN/IEC		E1203S-2WR3	12 (10.8-13.2)	± 3.3	$\pm 303/\pm 30$
	E1205S-2WR3	± 5	$\pm 200/\pm 20$		76/80	1200
-	E1207S-2WR3	± 7.2	$\pm 139/\pm 13$		76/80	470
	E1209S-2WR3	± 9	$\pm 111/\pm 11$		78/82	470
EN/BS EN/IEC	E1212S-2WR3	± 12	$\pm 83/\pm 8$		79/83	220
	E1215S-2WR3	± 15	$\pm 67/\pm 7$		79/83	220
-	E1224S-2WR3	± 24	$\pm 42/\pm 4$		79/83	100
EN/BS EN/IEC	F1205S-2WR3	5	400/40		78/82	2400
-	F12X6S-2WR3	6.4	312/31		78/82	1000
	F1209S-2WR3	9	222/22		78/82	1000
	F1212S-2WR3	12	167/17		80/84	560
EN/BS EN/IEC	F1215S-2WR3	15	133/13		81/85	560
	F1224S-2WR3	24	83/8		82/86	220

--	E1505S-2WR3	15 (13.5-16.5)	±5	±200/±20	76/80	1200
	E1515S-2WR3		±15	±67/±7	78/82	220
	F1505S-2WR3		5	400/40	76/80	2400
	F1509S-2WR3		9	222/22	76/80	1000
	F1512S-2WR3		12	167/17	77/81	560
	F1515S-2WR3		15	133/13	77/81	560
	F1524S-2WR3		24	83/8	77/81	220
	E2403S-2WR3		24 (21.6-26.4)	±3.3	±303/±30	70/76
EN/BS EN/IEC E2405S-2WR3	±5	±200/±20		74/80	1200	
--	E2407S-2WR3	±7.2		±139/±13	74/80	470
	E2409S-2WR3	±9		±111/±11	75/81	470
EN/BS EN/IEC	E2412S-2WR3	±12		±83/±8	77/83	220
	E2415S-2WR3	±15		±67/±7	77/83	220
--	E2424S-2WR3	±24		±42/±4	77/83	100
	F2403S-2WR3	3.3		400/40	70/76	2400
EN/BS EN/IEC	F2405S-2WR3	5		400/40	74/80	2400
--	F2407S-2WR3	7.2		278/27	74/80	1000
	F2409S-2WR3	9		222/22	75/81	1000
EN/BS EN/IEC	F2412S-2WR3	12		167/17	78/84	560
	F2415S-2WR3	15		133/13	80/86	560
--	F2418S-2WR3	18		111/11	80/86	220
EN/BS EN/IEC	F2424S-2WR3	24		83/8	80/86	220

Note: * The specified maximum capacitive load for positive and negative output is identical.

Input Specifications

Item	Operating Conditions	Min.	Typ.	Max.	Unit	
Input Current (full load / no-load)	5VDC input	3.3VDC output	--	534/8	564/--	mA
		5VDC/7.2VDC output	--	477/8	500/--	
		9VDC/12VDC output	--	471/8	494/--	
		15VDC/24VDC output	--	466/8	488/--	
	12VDC input	3.3VDC output	--	222/8	235/--	
		5VDC/7.2VDC output	--	208/8	219/--	
		9VDC output	--	203/8	214/--	
		12VDC/15VDC/24VDC output	--	201/8	211/--	
	15VDC input	5VDC/9VDC output	--	167/8	176/--	
		12VDC/15VDC/24VDC output	--	165/8	173/--	
	24VDC input	3.3VDC output	--	110/8	119/--	
		5VDC/7.2VDC output	--	104/8	112/--	
		9VDC output	--	103/8	111/--	
		12VDC output	--	99/8	107/--	
		15VDC/18VDC/24VDC output	--	97/8	104/--	
	Reflected Ripple Current*		--	15	--	
Surge Voltage (1sec. max.)	5VDC input	-0.7	--	9	VDC	
	12VDC input	-0.7	--	18		
	15VDC input	-0.7	--	21		
	24VDC input	-0.7	--	30		
Input Filter		Capacitance filter				
Hot Plug		Unavailable				

Note: * Refer to DC-DC Converter Application Notes for detailed description of reflected ripple current test method.

Output Specifications

Item	Operating Conditions		Min.	Typ.	Max.	Unit	
Voltage Accuracy			See output regulation curve (Fig. 1)				
Linear Regulation	Input voltage change: ±1%	3.3VDC output	--	--	±1.5	--	
		Others	--	--	±1.2		
Load Regulation	10%-100% load	5VDC input	3.3VDC output	--	10	20	%
			5/7.2VDC output	--	8	15	
			9/12/15 output	--	7	10	
			24VDC output	--	5	10	
		12/15/24VDC input	3.3VDC output	--	15	20	
			5VDC output	--	7	15	
			6.4VDC output	--	10	15	
			7.2VDC output	--	6	15	
			9/12VDC output	--	5	10	
			15VDC output	--	4	10	
Ripple & Noise*	20MHz bandwidth	5V input	--	75	200	mVp-p	
		12/15/24V input	--	75	180		
Temperature Coefficient	Full load		--	±0.02	--	%/°C	
Short-circuit Protection			Continuous, self-recovery				

Note: * The "parallel cable" method is used for Ripple and Noise test, please refer to DC-DC Converter Application Notes for specific information.

General Specifications

Item	Operating Conditions		Min.	Typ.	Max.	Unit
Isolation	Input-output electric strength test for 1 minute with a leakage current of 1mA max.		3000	--	--	VDC
Insulation Resistance	Input-output resistance at 500VDC		1000	--	--	MΩ
Isolation Capacitance	Input-output capacitance at 100kHz/0.1V		--	20	--	pF
Operating Temperature	Derating when operating temperature ≥ 85°C (see Fig. 2)		-40	--	105	°C
Storage Temperature			-55	--	125	°C
Case Temperature Rise	Ta=25°C		--	25	--	
Pin Soldering Resistance Temperature	Soldering spot is 1.5mm away from case for 10 seconds		--	--	300	
Storage Humidity	Non-condensing		5	--	95	%RH
Vibration			10-150Hz, 5G, 0.75mm. along X, Y and Z			
Switching Frequency	Full load, nominal input voltage	5V input	--	220	--	kHz
		12/15/24V input	--	260	--	
MTBF	MIL-HDBK-217F @ 25°C		3500	--	--	k hours

Mechanical Specifications

Case Material	Black plastic; flame-retardant and heat-resistant (UL94V-0)
Dimensions	19.65 x 7.05 x 10.16 mm
Weight	2.4g(Typ.)
Cooling Method	Free air convection

Electromagnetic Compatibility (EMC)

Emissions	CE	CISPR32/EN55032 CLASS B
	RE	CISPR32/EN55032 CLASS B
Immunity	ESD	IEC/EN61000-4-2 Air ±8kV, Contact ±6kV perf. Criteria B

Note: Refer to Fig. 4 for recommended circuit test

Typical Characteristic Curves

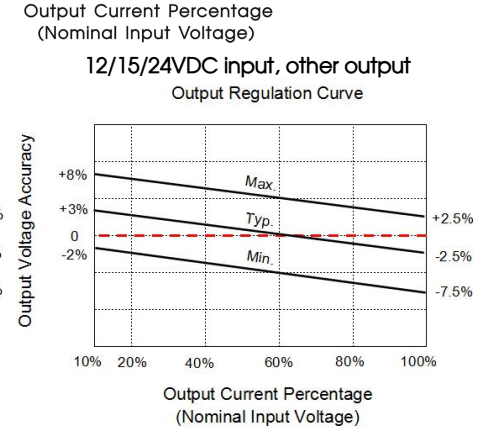
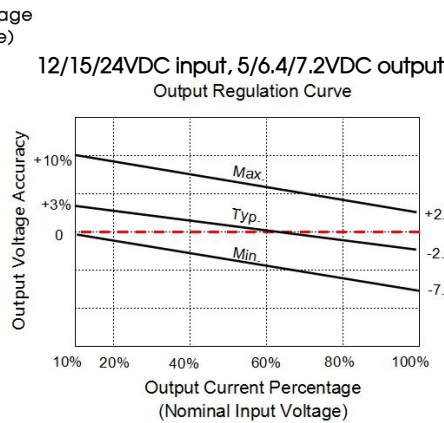
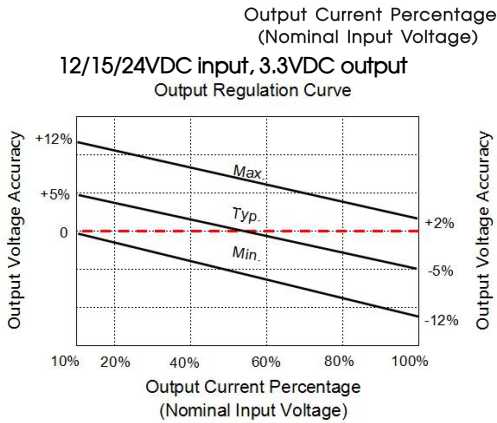
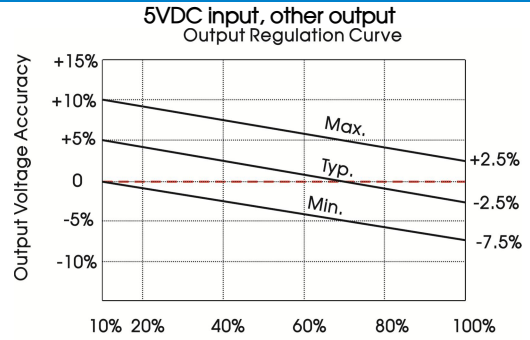
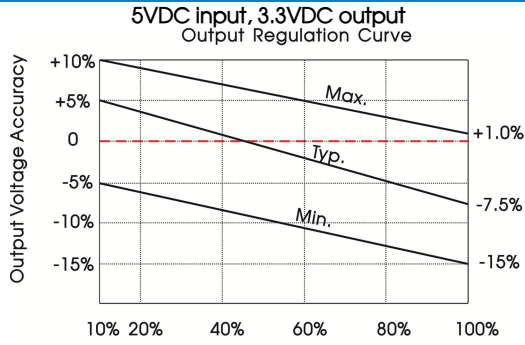

Fig. 1

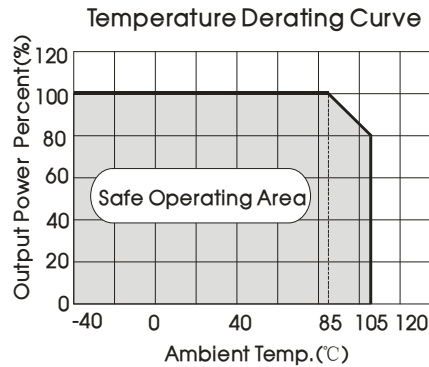
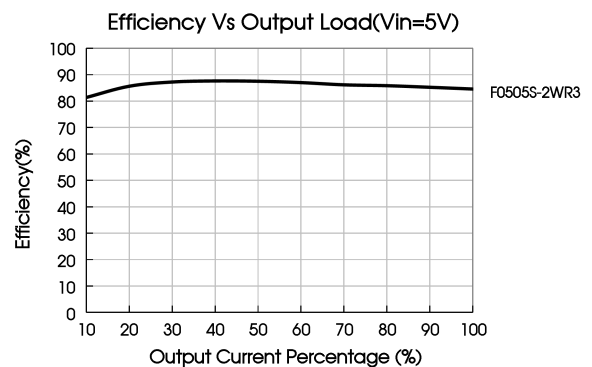
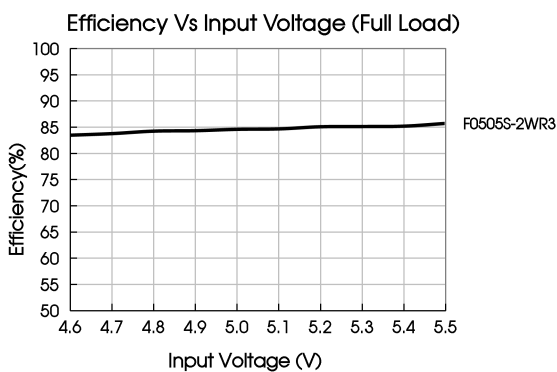

Fig. 2



Design Reference

1. Typical application

Input and/or output ripple can be further reduced, by connecting a filter capacitor from the input and/or output terminals to ground as shown in Fig. 3.

Choosing suitable filter capacitor values is very important for a smooth operation of the modules, particularly to avoid start-up problems caused by capacitor values that are too high. For recommended input and output capacitor values refer to Table 1.

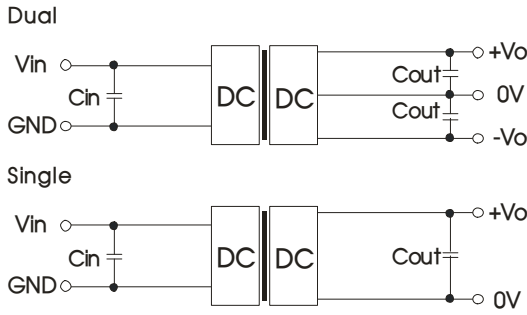

Fig. 3

Table 1: Recommended input and output capacitor values

Vin	Cin	Single Vout	Cout	Dual Vout	Cout*
5VDC	10μF/16V	3.3VDC	10μF/16V	±3.3VDC	4.7μF/16V
12VDC	2.2μF/25V	5VDC	10μF/16V	±5VDC	4.7μF/16V
15VDC	2.2μF/25V	6.4VDC	4.7μF/16V	±7.2VDC	2.2μF/25V
24VDC	1μF/50V	7.2VDC	2.2μF/25V	±9VDC	2.2μF/25V
--	--	9VDC	2.2μF/25V	±12VDC	1μF/25V
--	--	12VDC	2.2μF/25V	±15VDC	1μF/25V
--	--	15VDC	1μF/25V	±24VDC	0.47μF/50V
--	--	18VDC	1μF/50V	--	--
--	--	24VDC	1μF/50V	--	--

Note: *The capacitor value of the positive and the negative output is identical.

2. EMC compliance circuit

Single Output

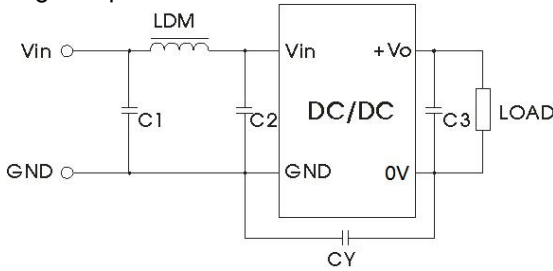

Input voltage		5VDC	12/15/24VDC
Emissions	C1/C2	4.7μF /16V	4.7μF /50V
	CY	270pF/4kV	
	C3	Refer to Cout in Fig. 3	
	LDM	6.8μH	

Dual Output

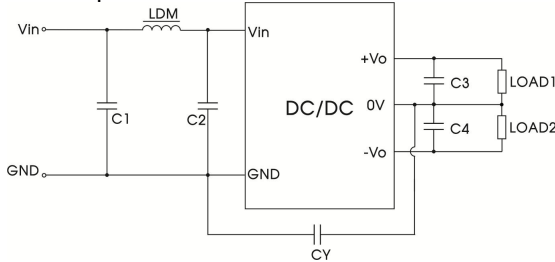
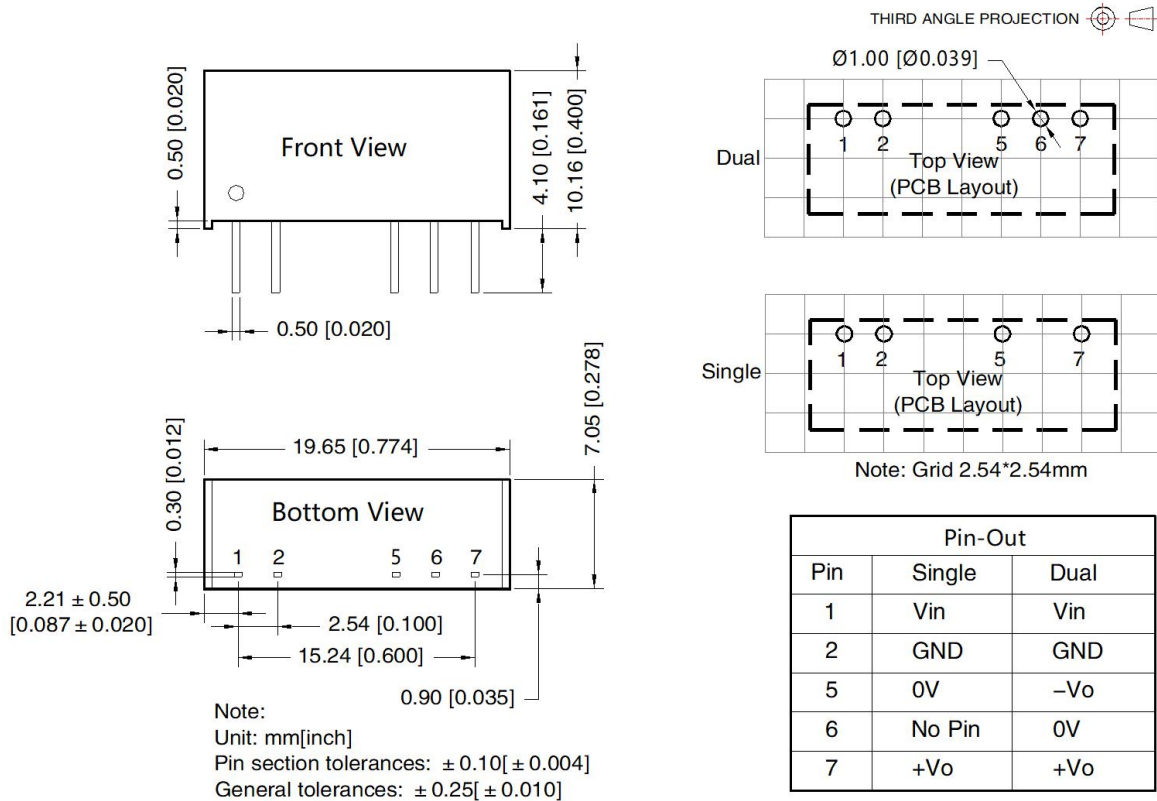

Fig. 4

Input voltage		5VDC	12/15/24VDC
Emissions	C1/C2	4.7μF /16V	4.7μF /50V
	CY	270pF/4kV	
	C3/C4	Refer to Cout in Fig. 3	
	LDM	6.8μH	

3. For additional information please refer to DC-DC converter application notes on www.mornsun-power.com

Dimensions and Recommended Layout



Notes:

1. For additional information on Product Packaging please refer to www.mornsun-power.com. Packaging bag number: 58200001;
2. If the product is not operated within the required load range, the product performance cannot be guaranteed to comply with all parameters in the datasheet;
3. The maximum capacitive load offered were tested at input voltage range and full load;
4. Unless otherwise specified, parameters in this datasheet were measured under the conditions of Ta=25°C, humidity<75%RH with nominal input voltage and rated output load;
5. All index testing methods in this datasheet are based on our company corporate standards;
6. We can provide product customization service, please contact our technicians directly for specific information;
7. Products are related to laws and regulations: see "Features" and "EMC";
8. Our products shall be classified according to ISO14001 and related environmental laws and regulations, and shall be handled by qualified units.

MORNSUN Guangzhou Science & Technology Co., Ltd.

Address: No. 8 Nanyun 4th Road, Huangpu District, Guangzhou, China

Tel: 86-20-38601850

Fax: 86-20-38601272

E-mail: info@mornsun.cn

www.mornsun-power.com