

DETAILS

Product Number	C12361_HB-2X2-W
Family	HighBay
Type	Lens array
Color	clear
Diameter	50x50 mm
Height	8,5 mm
Style	square
Optic Material	PMMA
Holder Material	
Fastening	glue, pin, screw
Status	production ready
ROHS Compliant	Yes
Date Updated	3/01/2017



OPTICAL PROPERTIES

LED	Viewing Angle	Light Beam	Efficiency	cd/lm	Connector
SMD 5050	55 deg	HighBay	94 %	0.940	-
XM-L	57 deg	HighBay	89 %	0.860	-
XP-G	52 deg	HighBay	88 %	0.920	-
XP-E	sim: 50	HighBay	-	-	-
XT-E	50 deg	HighBay	87 %	0.970	-
XB-D	48 deg	HighBay	86 %	0.960	-
XP-G2	51 deg	HighBay	88 %	0.900	-
XM-L2	56 deg	HighBay	87 %	0.900	-
XP-L	56 deg	HighBay	87 %	0.800	-
XQ-E HI	sim: 42	HighBay	sim: 93 %	sim: 1.370	-
XHP35 HI	sim: 52	HighBay	sim: 93 %	sim: 1.200	-
XP-G3	sim: 54	HighBay	sim: 94 %	sim: 1.000	-
XP-L2	56 deg	HighBay	92 %	0.830	-
H35C1 (LEMWA33)	53 deg	HighBay	86 %	1.000	-
LUXEON A	sim: 52	HighBay	-	-	-
LUXEON Rebel	sim: 52	HighBay	-	-	-
LUXEON Rebel ES	51 deg	HighBay	87 %	0.940	-
LUXEON T	55 deg	HighBay	87 %	0.900	-
LUXEON Z ES	46 deg	HighBay	87 %	1.180	-
LUXEON H50-2	sim: 52	HighBay	sim: 91 %	sim: 4.700	-
LUXEON Q	50 deg	HighBay	86 %	0.900	-
LUXEON MZ	53 deg	HighBay	92 %	1.000	-
LUXEON TX	50 deg	HighBay	88 %	1.000	-
LUXEON 5050	55 deg	HighBay	94 %	0.940	-
LUXEON 3030 2D	sim: 49	HighBay	sim: 94 %	sim: 1.200	-

OPTICAL PROPERTIES

LED	Viewing Angle	Light Beam	Efficiency	cd/lm	Connector
LUXEON 3535L	sim: 49	HighBay	sim: 94 %	sim: 1.200	-
NVSxx19A	sim: 50	HighBay	-	-	-
NCSxx19A	48 deg	HighBay	85 %	1.100	-
NS9x383	54 deg	HighBay	86 %	0.880	-
NVSxx19B/NVSxx19C	51 deg	HighBay	85 %	0.960	-
NCSxx19B	50 deg	HighBay	85 %	1.000	-
NWSx229A	57 deg	HighBay	86 %	0.860	-
NVSW3x9A	53 deg	HighBay	92 %	0.900	-
NVSxE21A	43+43 deg	HighBay	86 %	1.100	-
OLP-5065F6L-06A	56 deg	HighBay	88 %	0.940	-
Oslon SSL 80	43 deg	HighBay	89 %	1.260	-
Oslon Square PC	54 deg	HighBay	87 %	0.900	-
Duris S8	sim: 56	HighBay	sim: 86 %	sim: 1.000	-
Oslon Square Gen3	sim: 50	HighBay	sim: 93 %	sim: 1.300	-
Duris P8	sim: 48	HighBay	sim: 93 %	sim: 1.200	-
Fortimo FastFlex LED board 2x8 DA G4	52 deg	HighBay	94 %	0.990	-
Fortimo FastFlex LED board 2x8 DAX G4	sim: 54	HighBay	sim: 94 %	sim: 1.000	-
LH351A(3535)	49 deg	HighBay	89 %	1.000	-
LH351Z	50 deg	HighBay	87 %	1.000	-
LH351B	55 deg	HighBay	86 %	0.930	-
LH351D	56 deg	HighBay	91 %	0.850	-
LH351C	53 deg	HighBay	93 %	1.000	-
LH508A	56 deg	HighBay	93 %	0.900	-
Z5	48 deg	HighBay	88 %	1.000	-
Z5M1/Z5M2	51 deg	HighBay	85 %	1.000	-
Z8Y15	45 deg	HighBay	79 %	0.900	-
Z8Y19	46 deg	HighBay	79 %	0.900	-
Z5M1/Z5M2	sim: 52	HighBay	sim: 94 %	sim: 1.100	-
Z8Y22P	51 deg	HighBay	92 %	0.910	-
Acrich MJT 4040	sim: 52	HighBay	sim: 94 %	sim: 1.100	-
TL1L4	48 deg	HighBay	81 %	0.980	-
RLE G1 49x223mm 4000lm xxx EXC OTB2	deg	HighBay	94 %	0.980	-
RLE G1 49x245mm 4000lm xxx EXC OTB2	deg	HighBay	94 %	0.980	-
RLE G1 49x121mm 2000lm xxx EXC OTB2	deg	HighBay	94 %	0.980	-
RLE G1 49x133mm 2000lm xxx EXC OTB2	deg	HighBay	94 %	0.980	-

Relative intensity of C12361_HB-2X2-W-(XPG2)

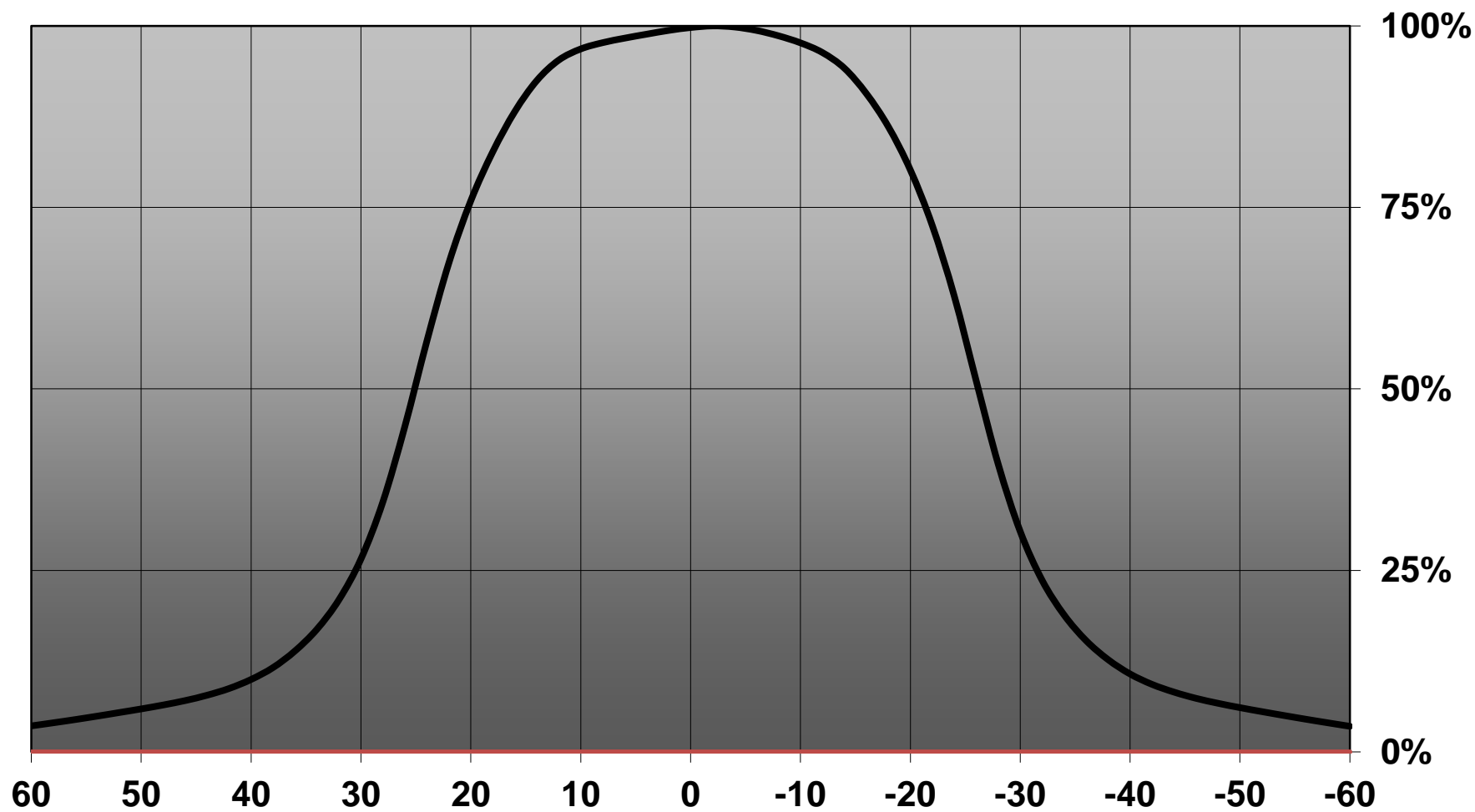

D

C

B

A

4

4

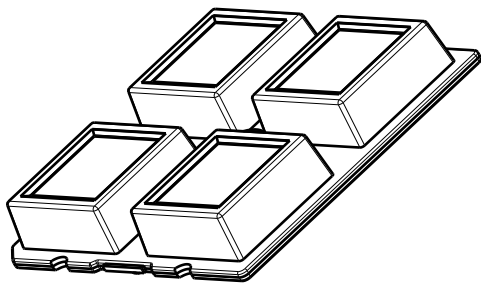

Isometric view

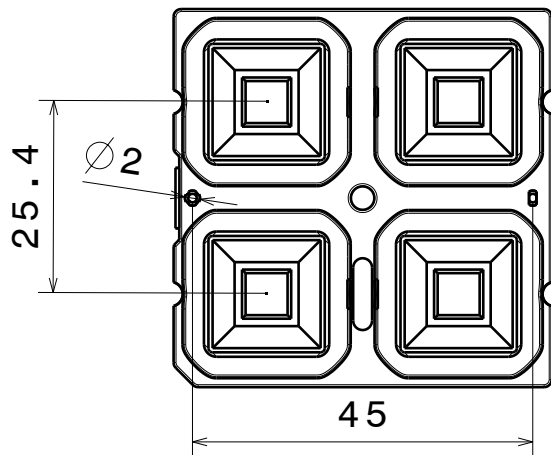

Bottom view

3

3

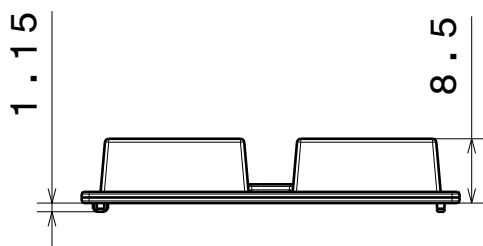

Front view

2

2

MATERIALS
Lens: PMMA

M3 screw
recommended for
fastening

Fastening also
with glue

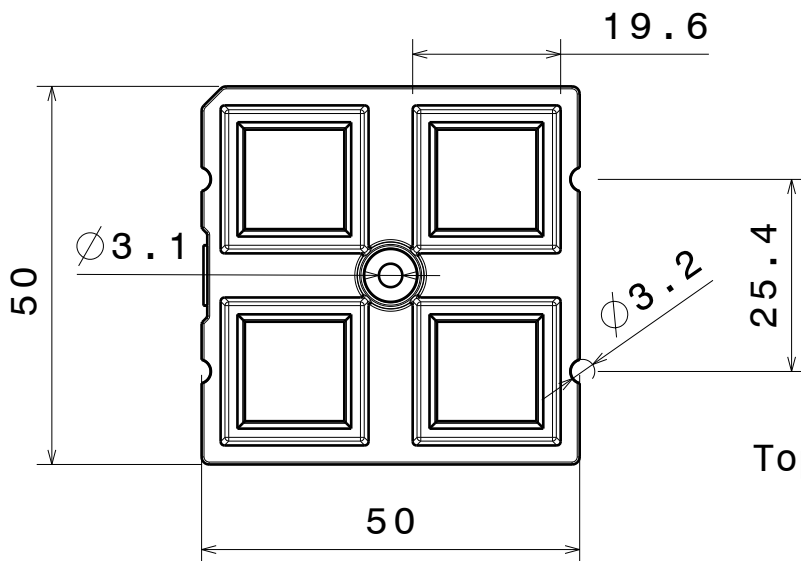

Top view

Tolerances if not otherwise shown
According to DIN ISO 2768-1
Linear measures:
Up to 30mm class M, otherwise class C.
According to DIN ISO 2768-2
Form and position: class L



Ledil Oy
Salorankatu 10
FIN 24240 SALO
Finland

THIRD ANGLE PROJECTION:

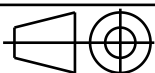

DRAWING TITLE

Datasheet HB-2x2 Lens module

This drawing is the property
of LEDiL Oy. It may not be
reproduced, copied or
communicated without a written
agreement with LEDiL Oy."

SIZE PART NUMBER

A4

C12361

SCALE 1:1 WEIGHT -

SHEET 1/1

D

A

1

Luminaire: LEDiL Oy C12361_HB-2X2-W (Bridgelux_5050_Gen2)

Lamps: 1 x Bridgelux_5050_Gen2_2x2_(BXEP-57C-435-09B)_1447.45lm@250mA_CCT=5700K_P=8.29761W_I=0.25A

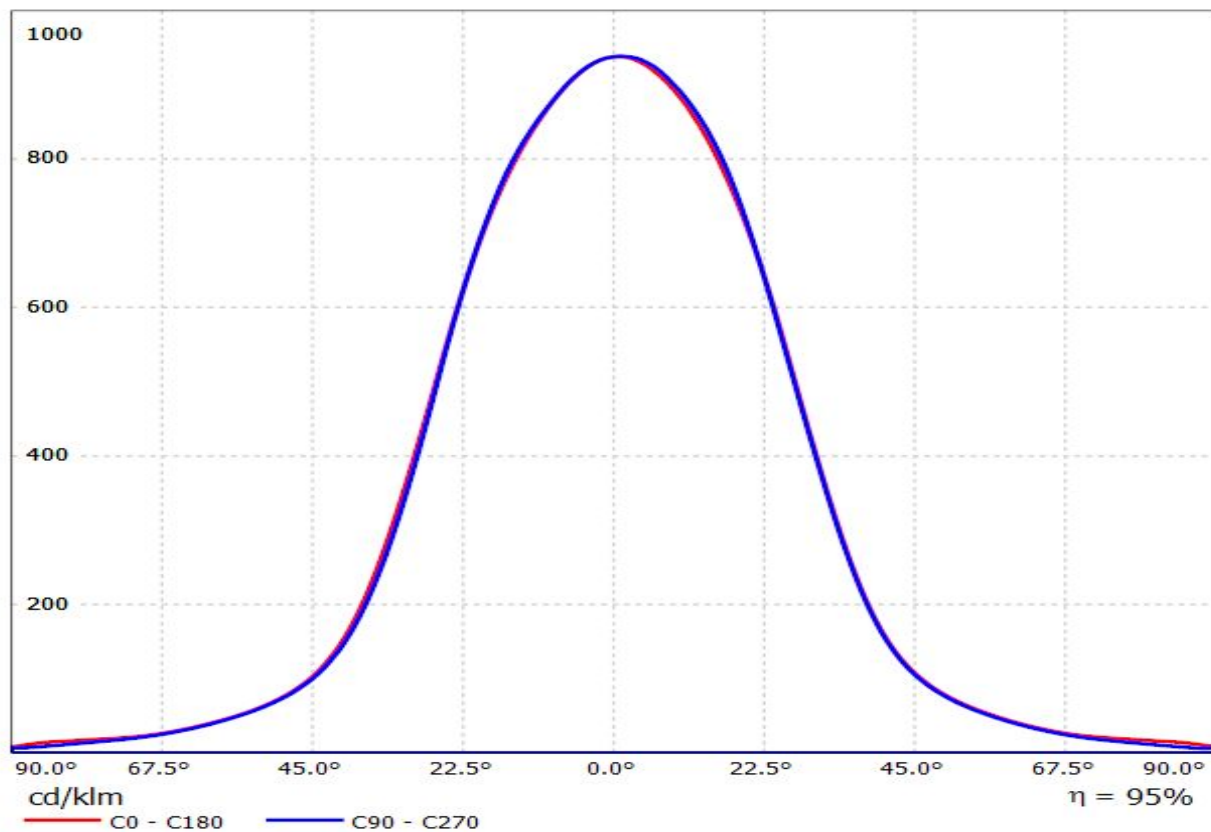

Luminaire: LEDIL OY C12361_HB-2X2 (XM-L) Efficiency=89%

Lamps: 1 x Cree XM-L (395lm @ 250mA)

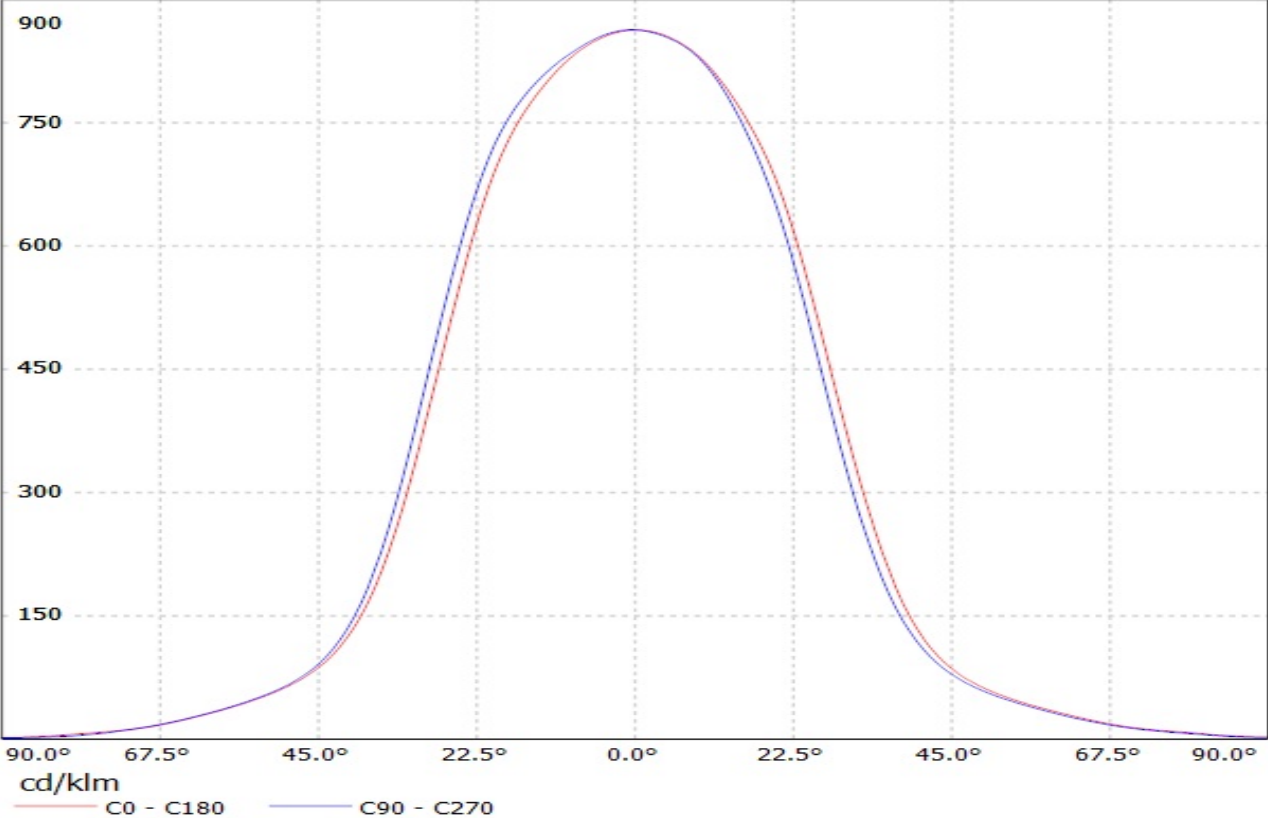

Luminaire: LEDIL OY C12361_HB-2X2 (XP-G) Efficiency=88%
Lamps: 1 x Cree XP-G (257lm @ 250mA)

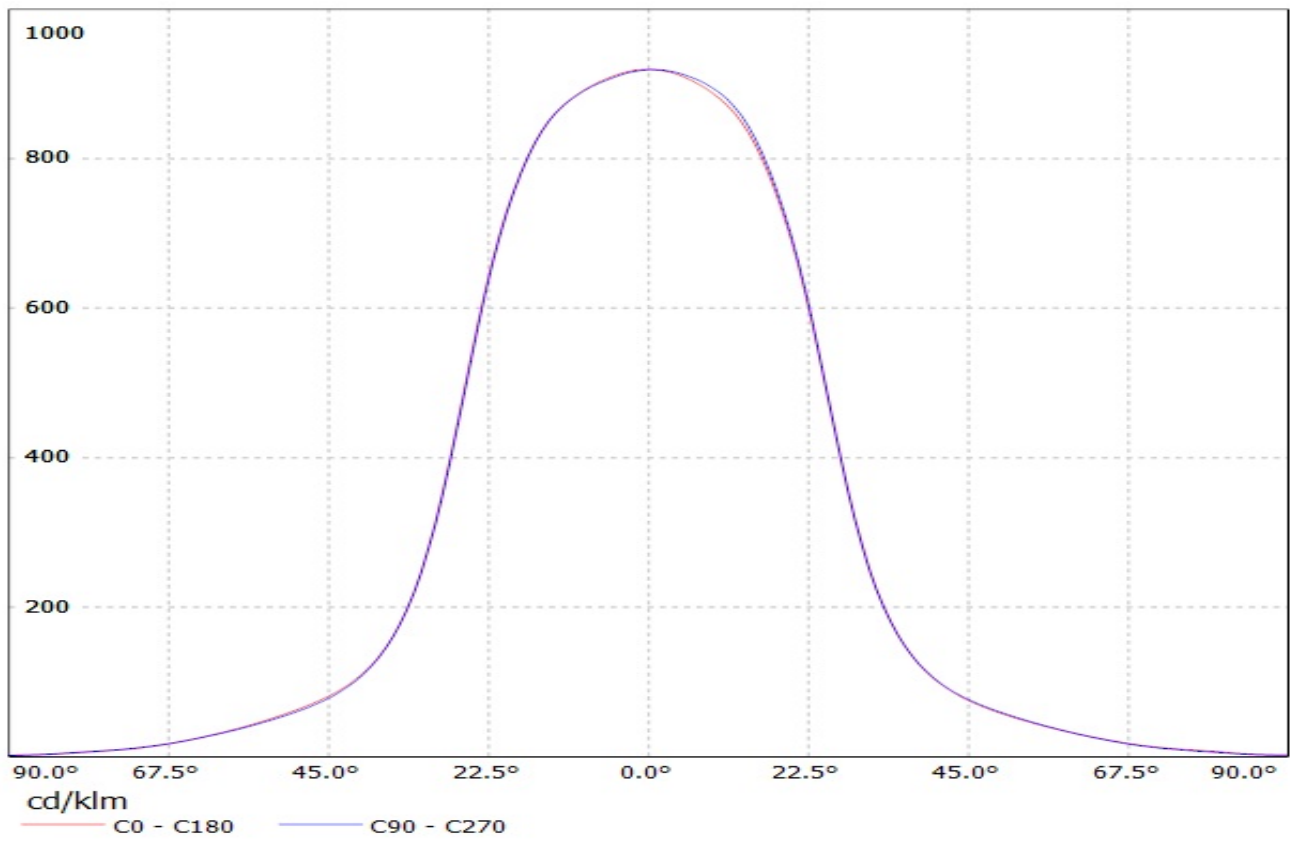

Luminaire: LEDIL OY C12361_HB-2X2 (XT-E AWT) Efficiency=89%
Lamps: 1 x Cree XT-E AWT (390lm@250mA)

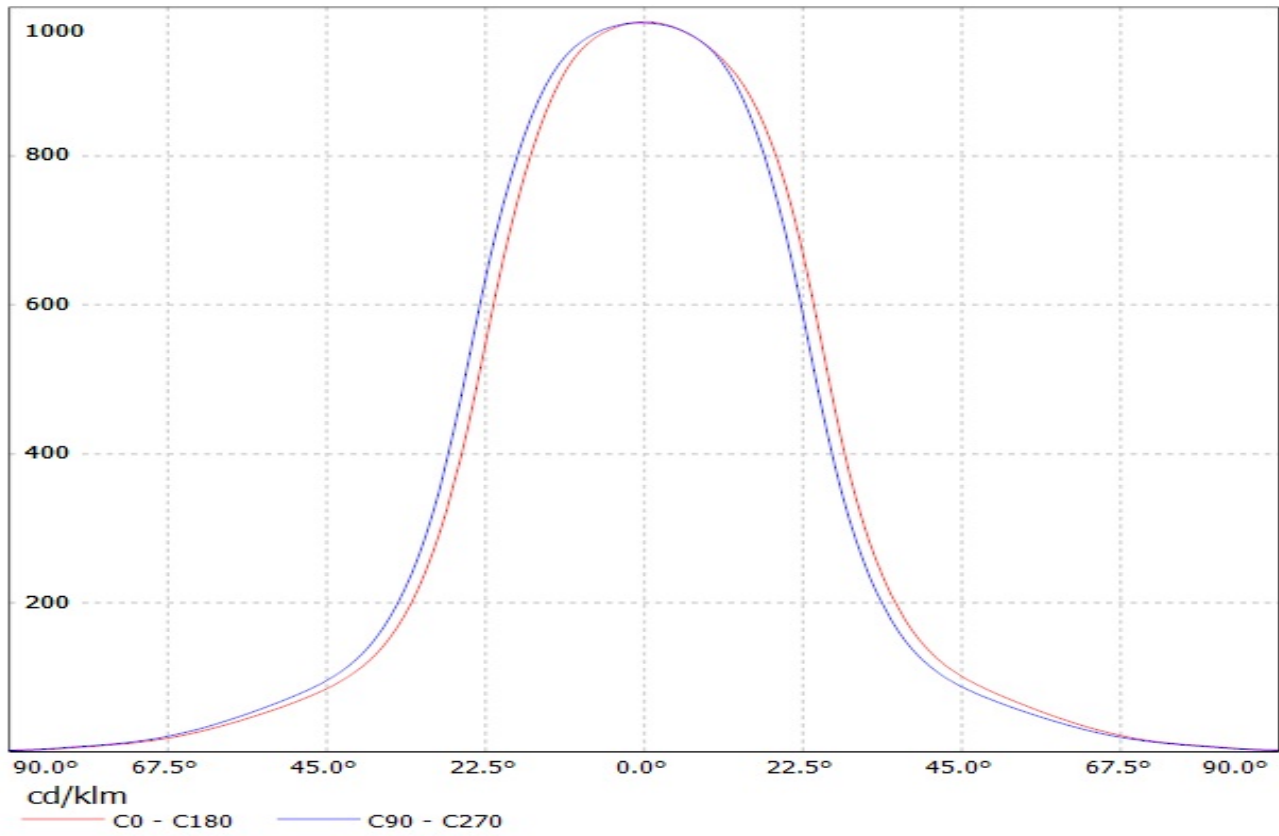

Luminaire: LEDIL OY C12361_HB-2X2 (XB-D) Efficiency=86%
Lamps: 1 x Cree XB-DE (371lm @ 250mA)

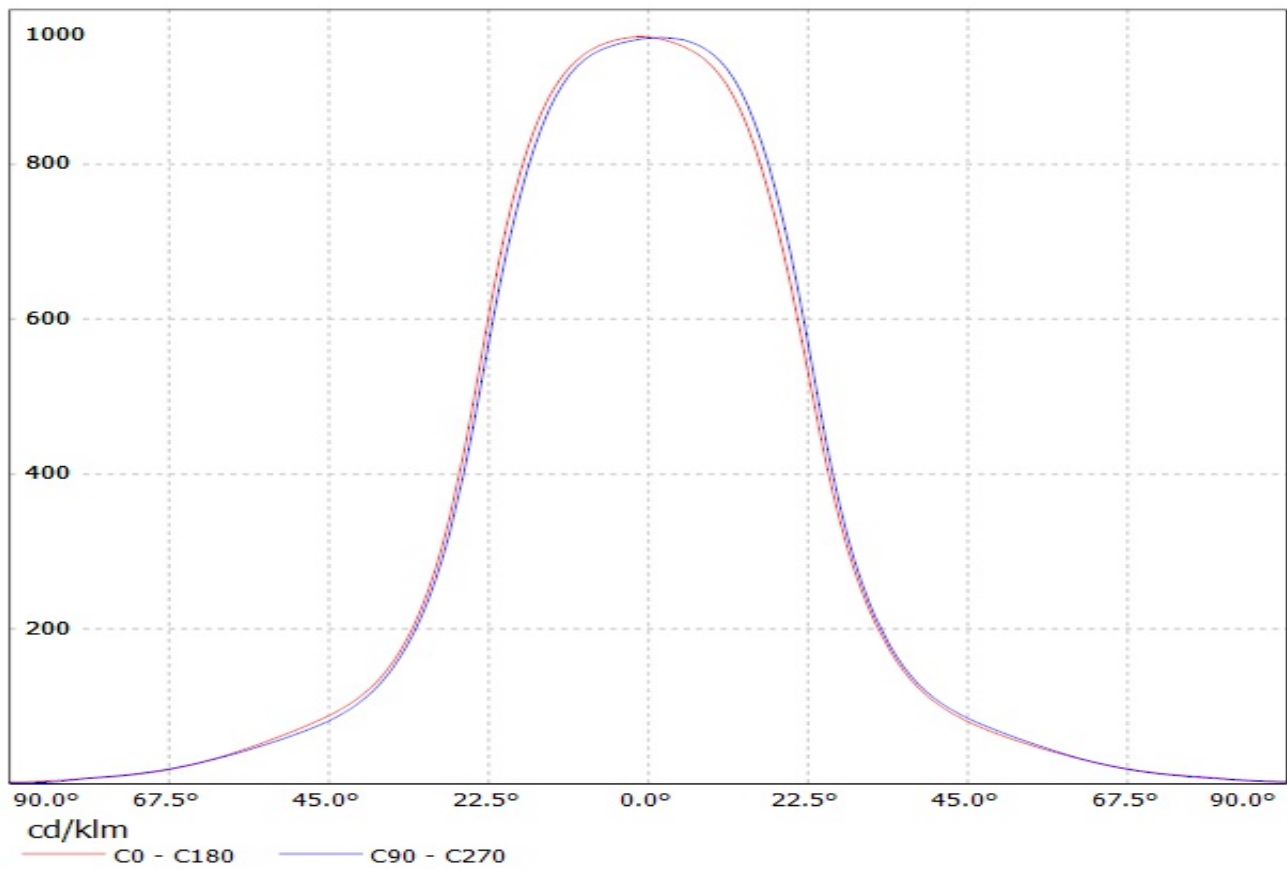

Luminaire: Ledil Oy C12361_HB-2X2-W_(XM-L2) Efficiency=87%
Lamps: 1 x Cree XM-L2 (CXMLBWT-0-7B4-T30-0L-001) 360lm @ 250mA CCT=3220K P=2.8W I=250mA

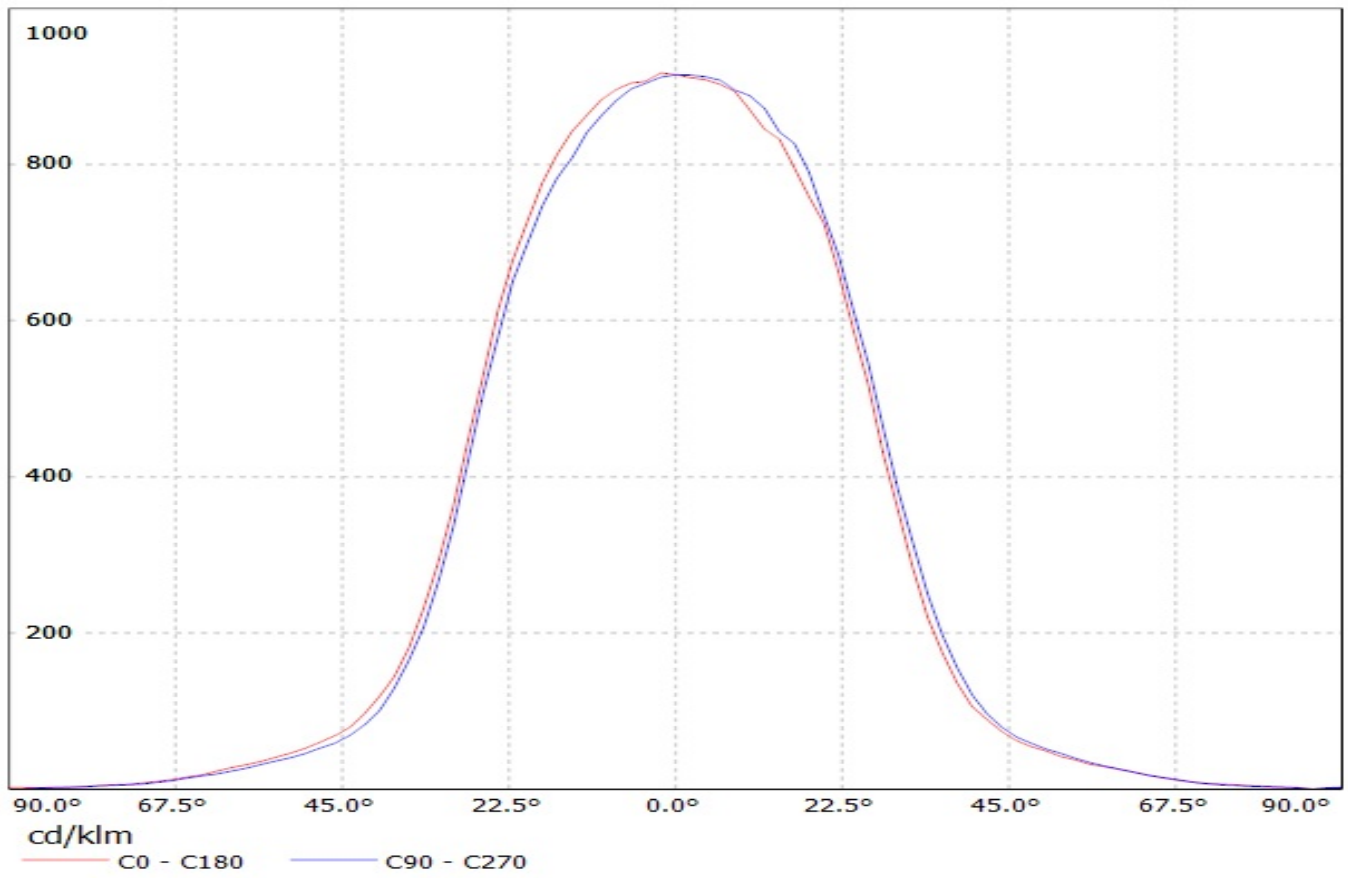

Luminaire: LEDiL Oy C12361_HB-2X2-W_(XP-L) Eff.87.0%

Lamps: 1 x CREE_XP-L_2x2_(XPLAWT-0-1B0-V40-00-0001)_504.373lm@250mA_CCT=7600K_P=2.79963W_I=249.9mA

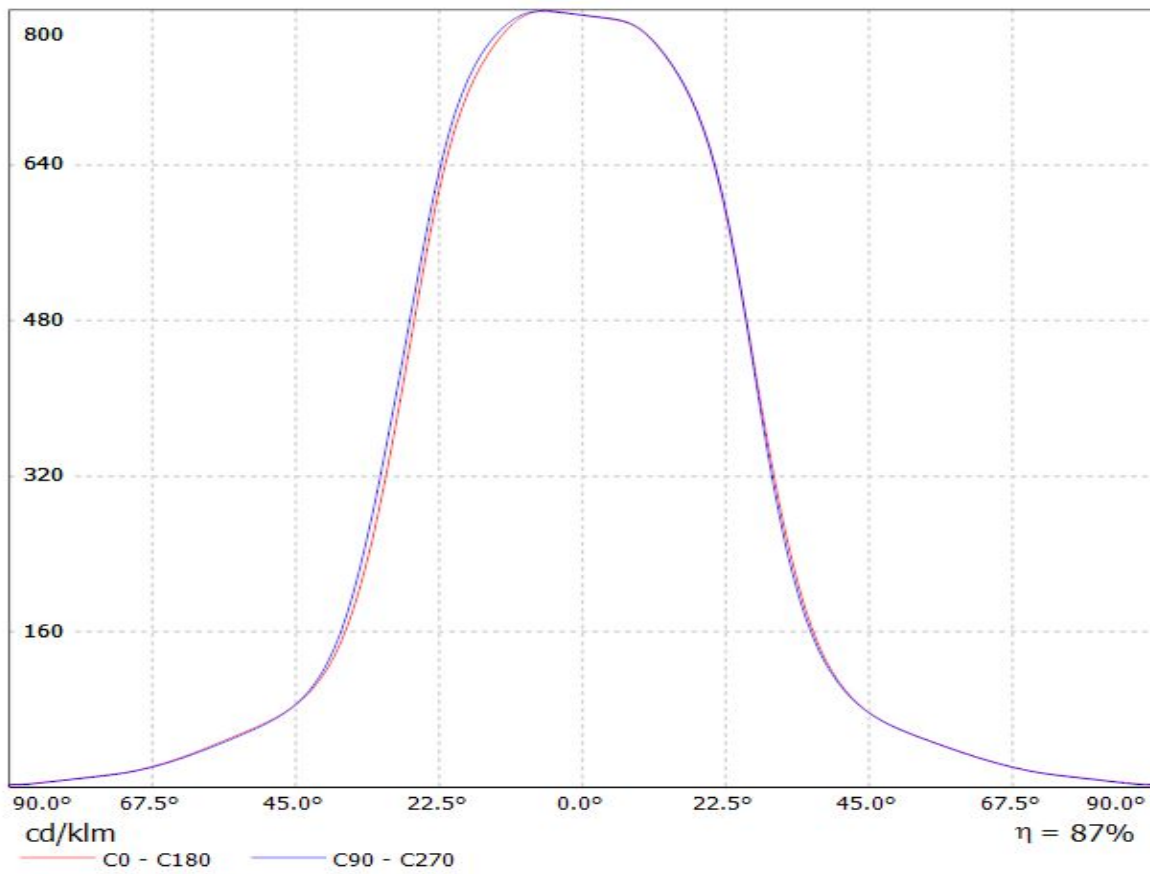

Luminaire: Ledil Oy C12361_HB-2X2-W_(XP-G3)_SIMULATED
Lamps: 1 x Cree XP-G3

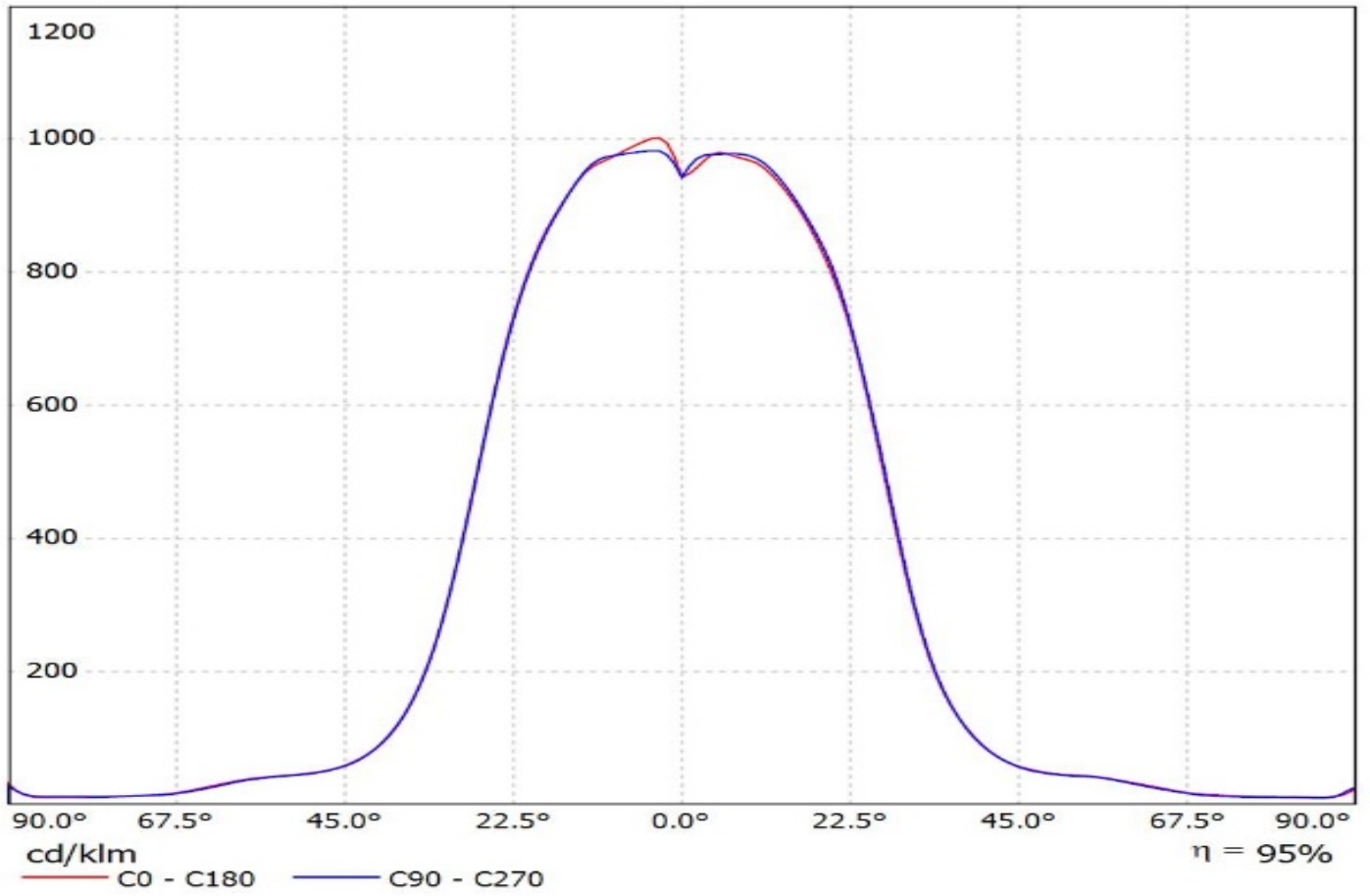

Luminaire: Ledil C12361_HB-2X2-W_(XP-L2)

Lamps: 1 x Cree_XP-L2_2x2_(XPLBWT-00-0000-000BV50E3)550.93lm@250mA_P=2.7815W_I=0.25A

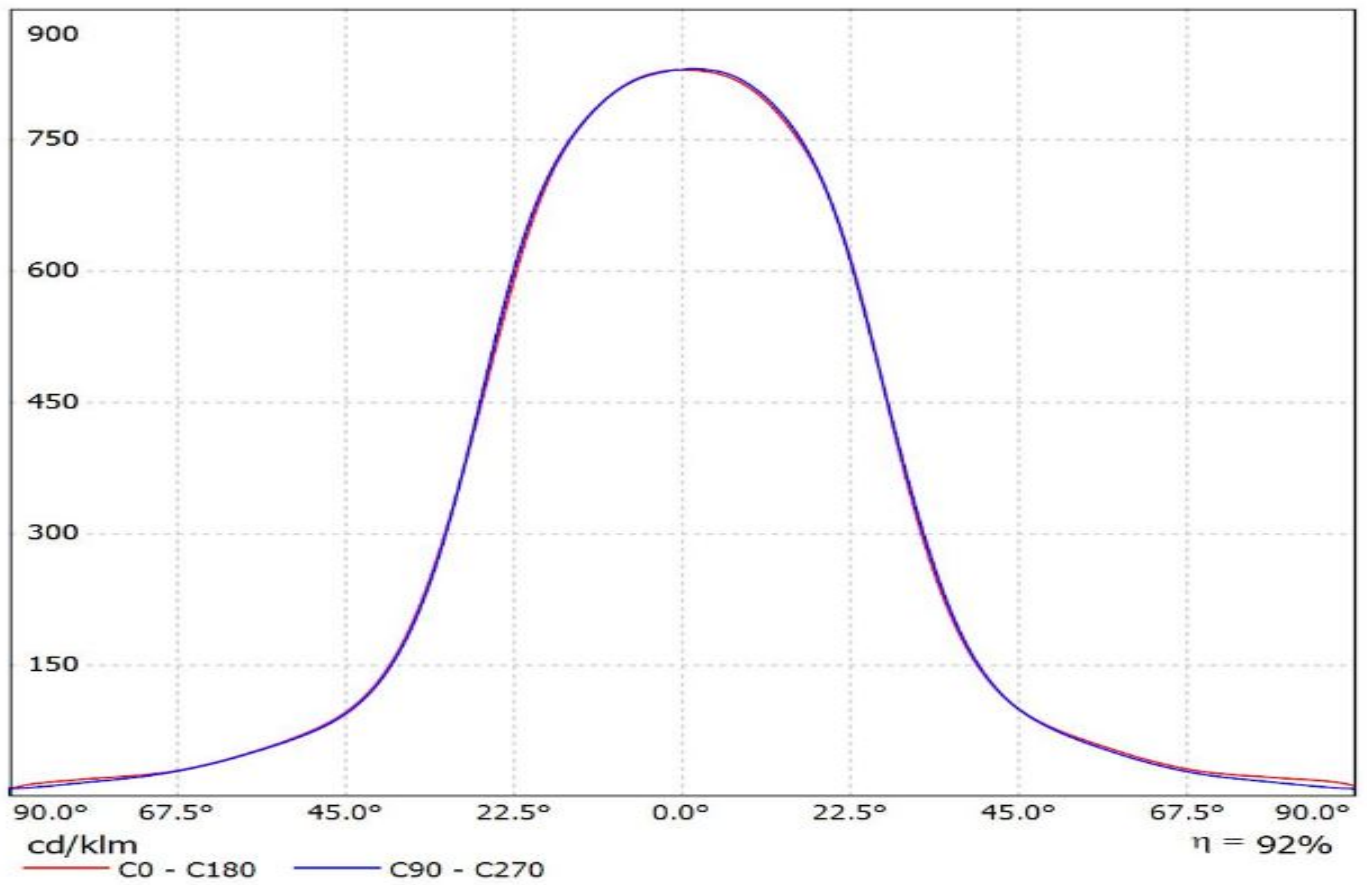

Luminaire: Ledil Oy C12361_HB-2X2-W_(3535_Ceramic_gen2) Efficiency=86%
Lamps: 1 x LG 3535 Ceramic gen2 (PKG5700K) 461lm @ 250mA CCT=6600K P=2.9W I=250mA

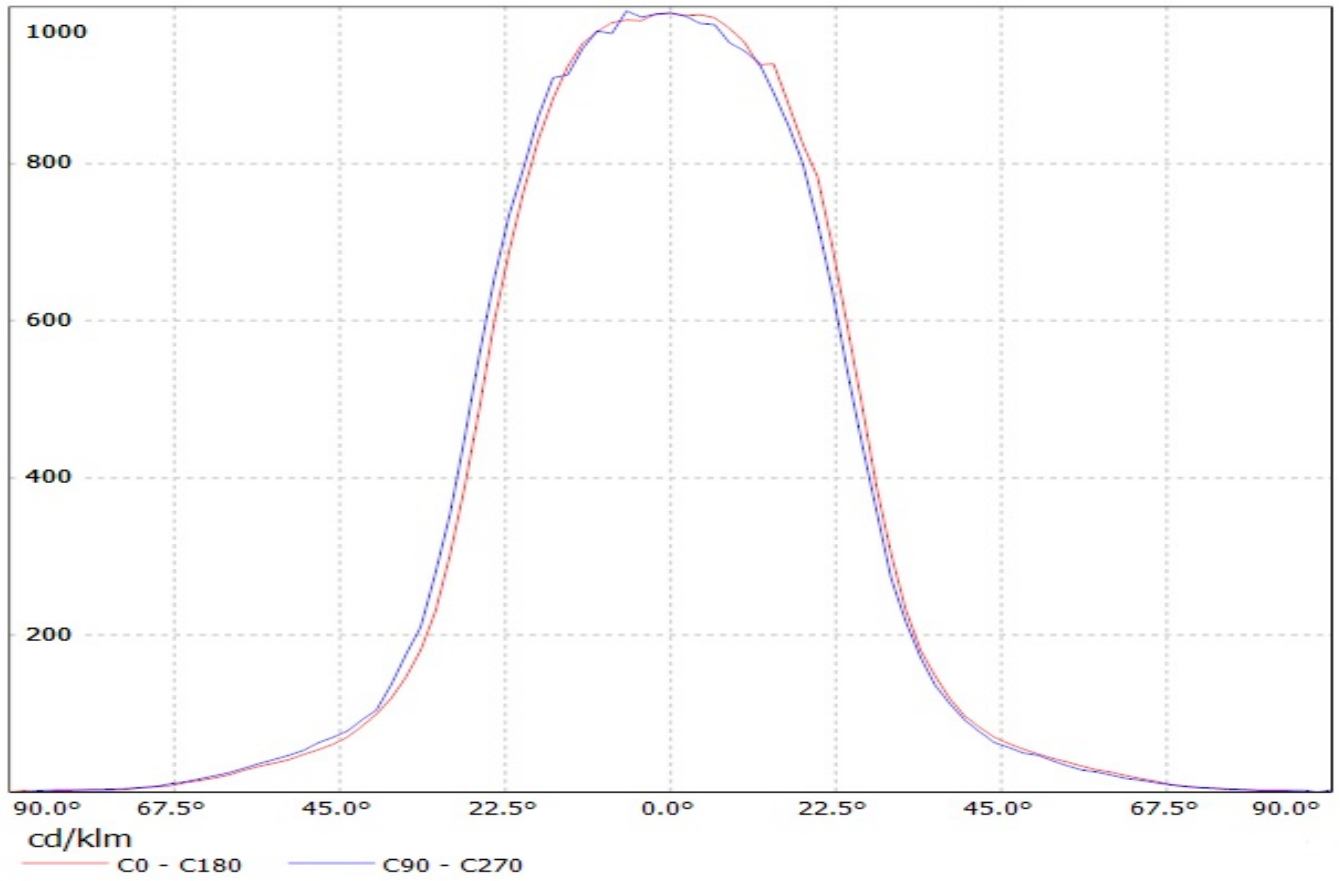

Luminaire: LEDIL OY C12361_HB-2X2 (RE-ES) Efficiency=87%
Lamps: 1 x Luxeon Rebel-ES (339lm @ 250mA)

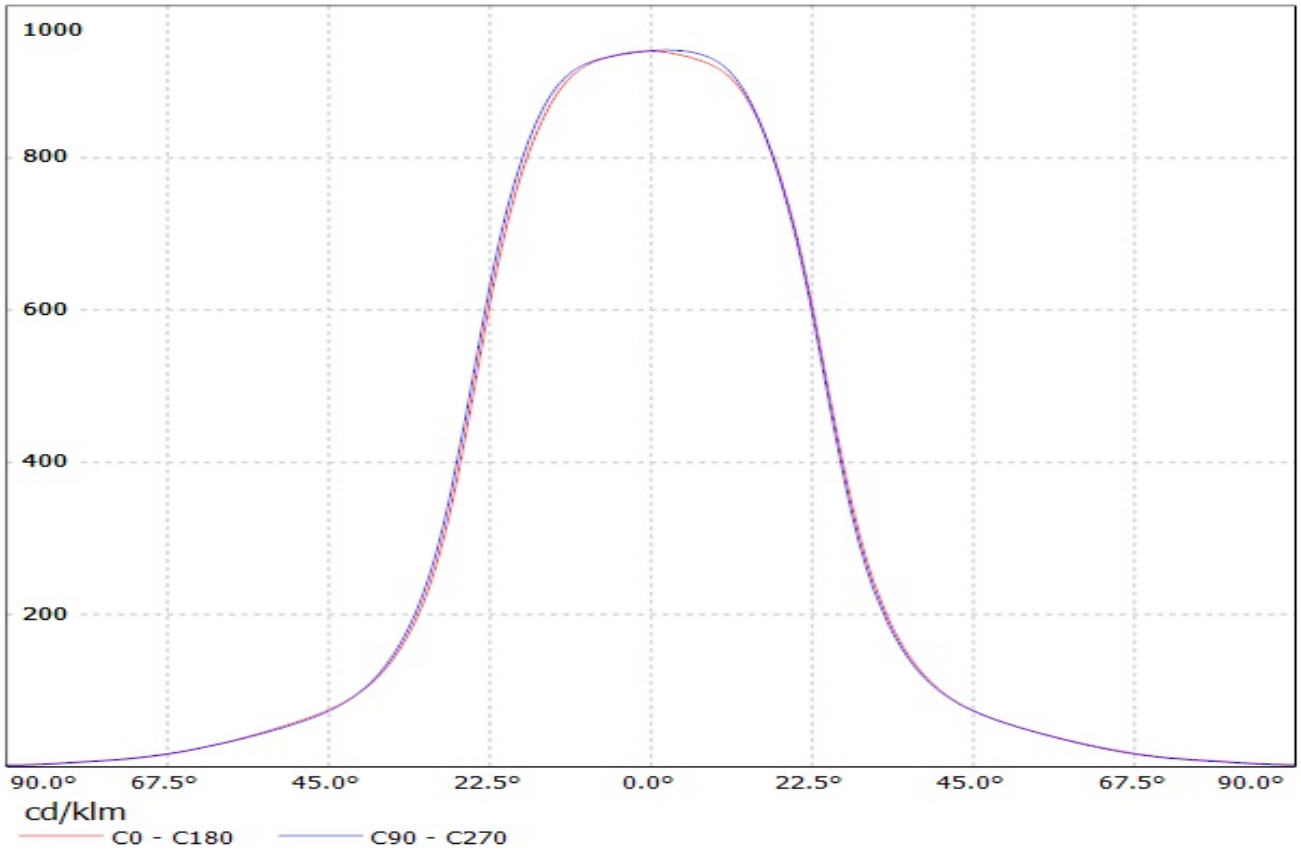

Luminaire: LEDiL Oy C12361_HB-2X2-W (LUXEON_T)_1 Eff.87.0%
Lamps: 1 x LUXEON_T 2x2 (294lm@250mA)

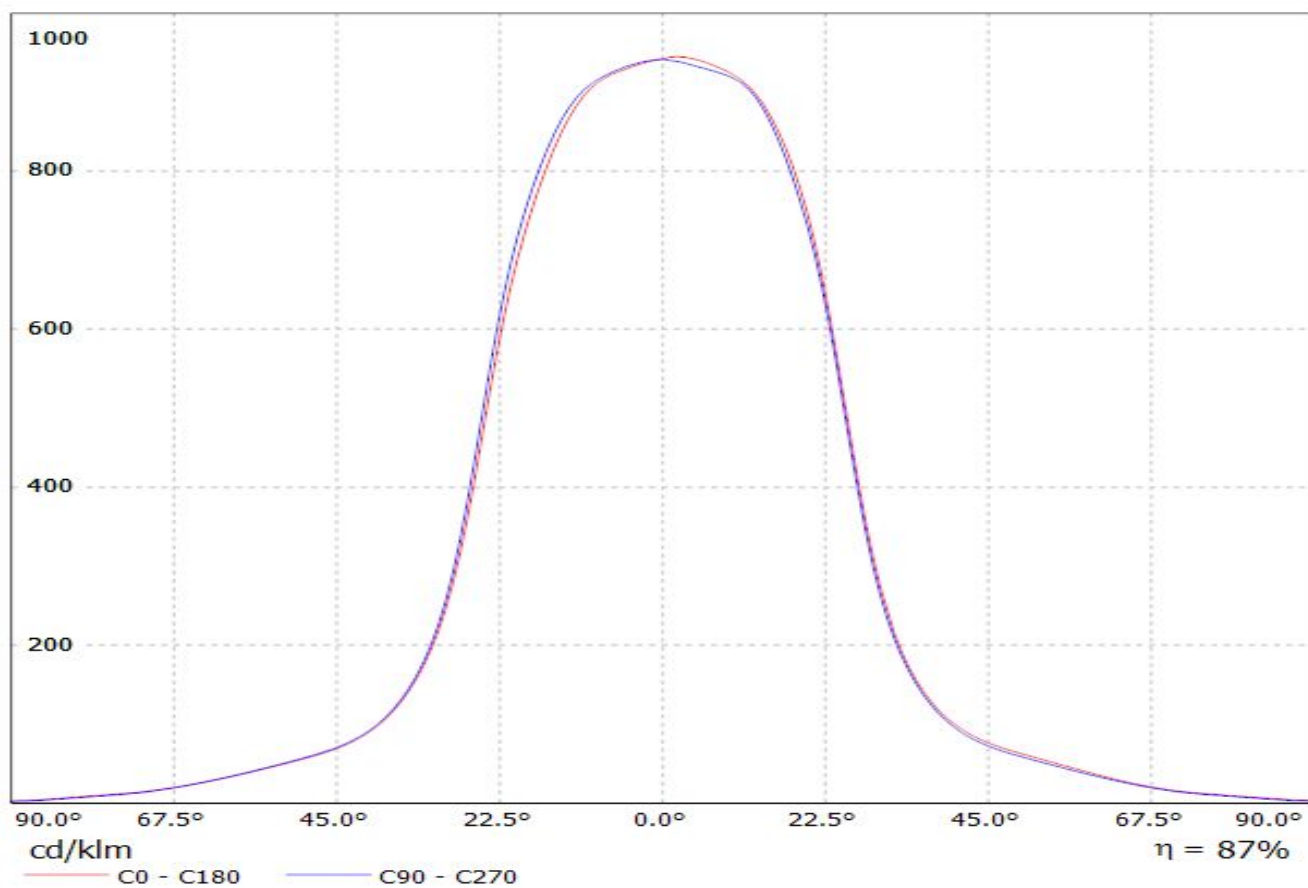

Luminaire: Ledil Oy C12361_HB-2X2-W_(Luxeon_Z_ES) Efficiency=87%
Lamps: 1 x Luxeon Z ES 2x2 (LXZ2-3090) 209lm @ 250mA CCT=3000K P=2.8W I=250mA

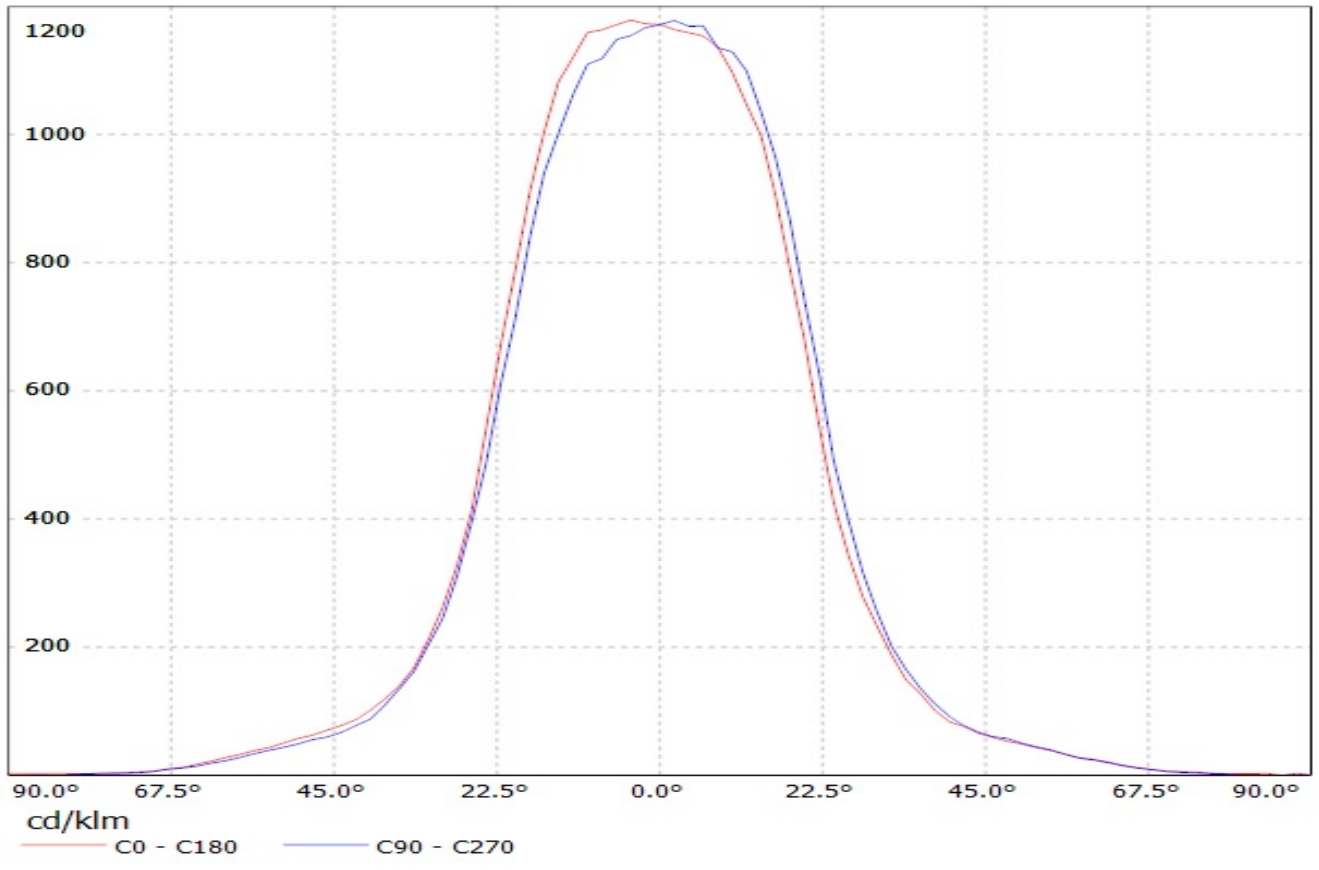

Luminaire: LEDiL Oy C12361_HB-2X2-W_(LUXEON_Q) Eff.86.3%
Lamps: 1 x LUXEON_Q_2x2_(LHQ-3080)_298.363lm@250mA_P=2.87385W_I=249.9mA

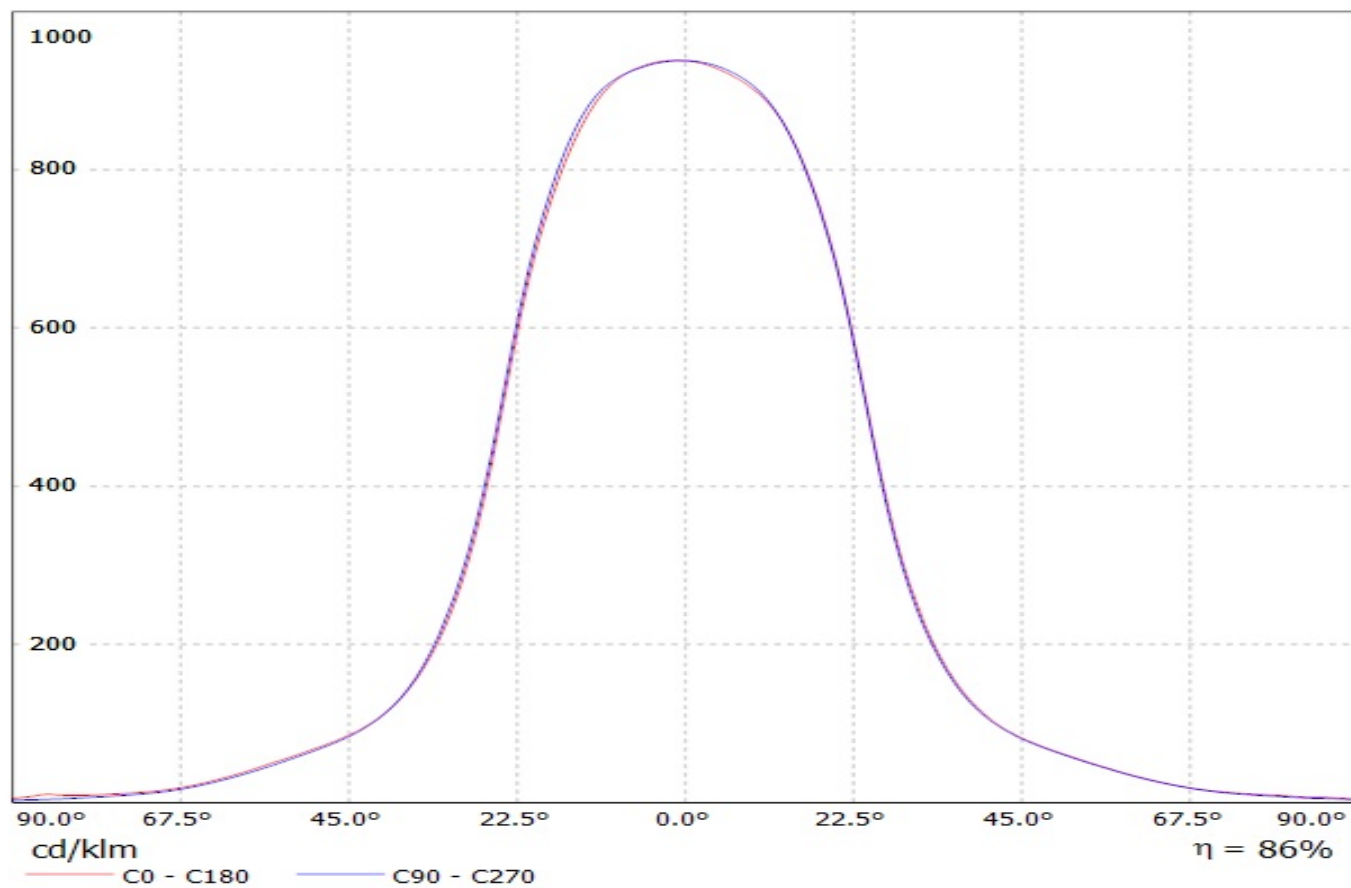

Luminaire: Ledil C12361_HB-2X2-W_(Luxeon_MZ)

Lamps: 1 x Philips_Lumileds_Luxeon_MZ_(LMZ7-QW57)_(2x2)_427.268lm@250mA_P=2.734W_I=0.2500A

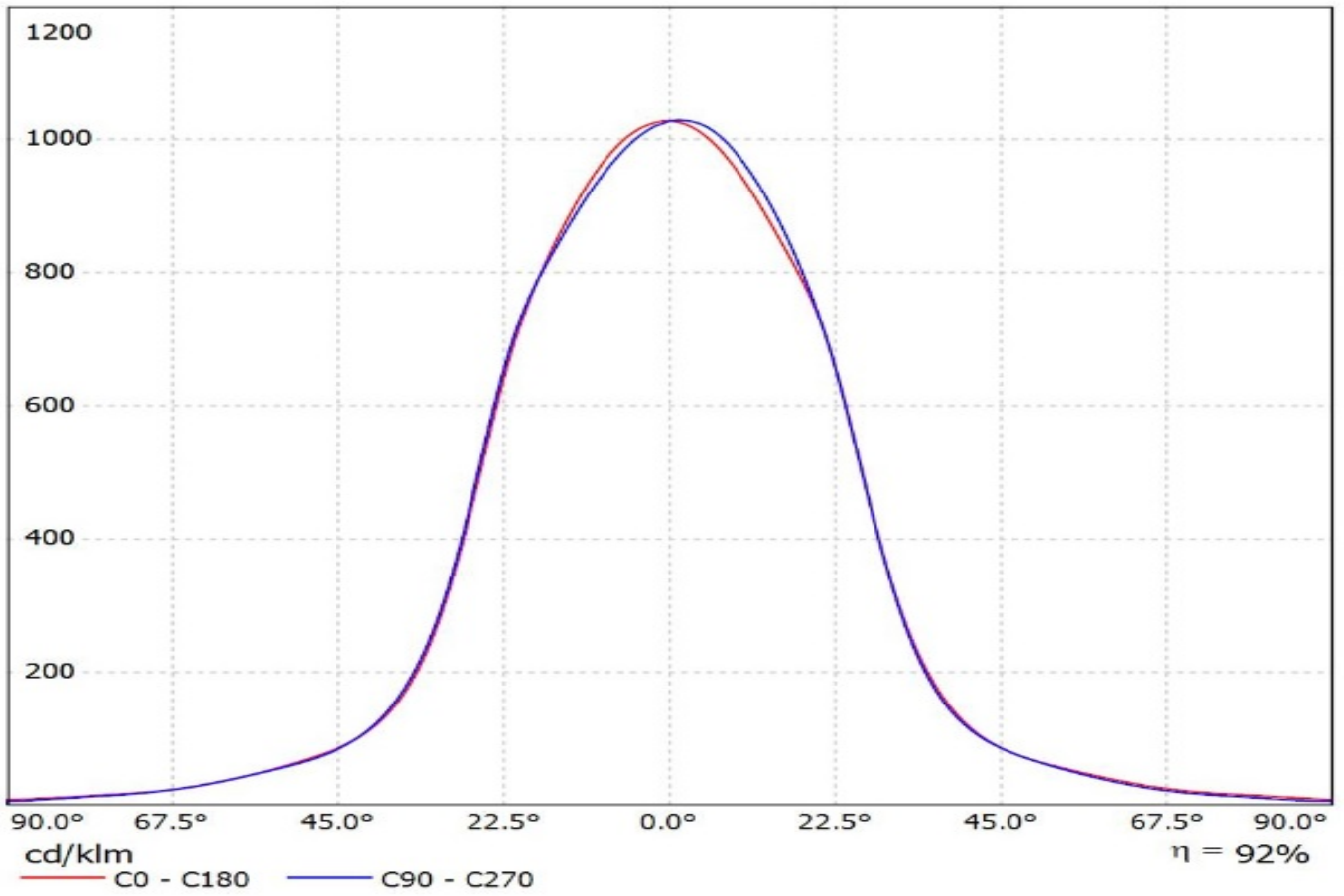

Luminaire: LEDiL Oy C12361_HB-2X2-W_(Luxeon_TX) Eff.87.5%
Lamps: 1 x Luxeon_TX_2x2_320.412lm@250mA_P=2.79013W_I=249.9mA

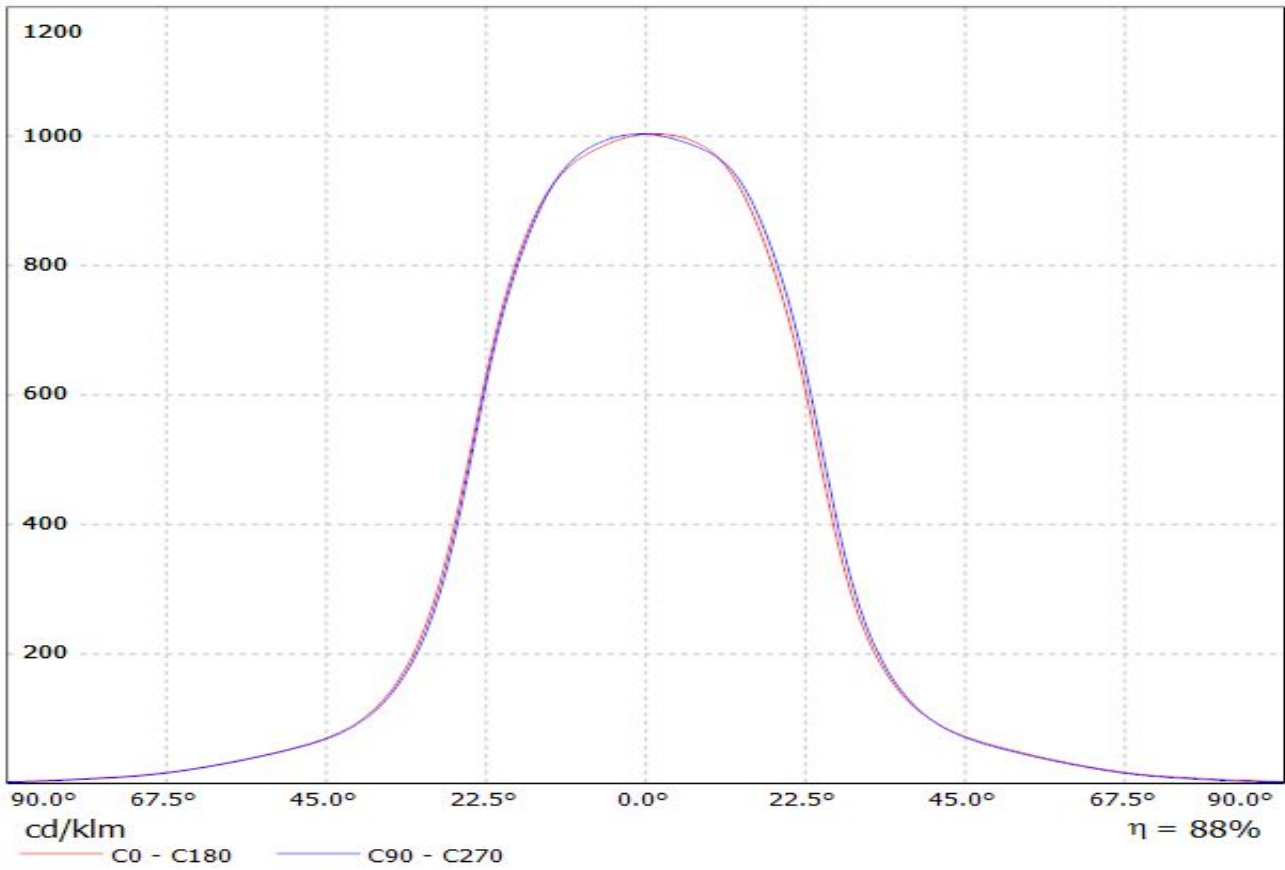

Luminaire: LEDiL Oy C12361_HB-2X2-W_(Luxeon_5050)

Lamps: 1 x Luxeon_5050_2x2_1270.76lm@80mA_CCT=5700K_P=7.35815W_I=0.080A_70CRI

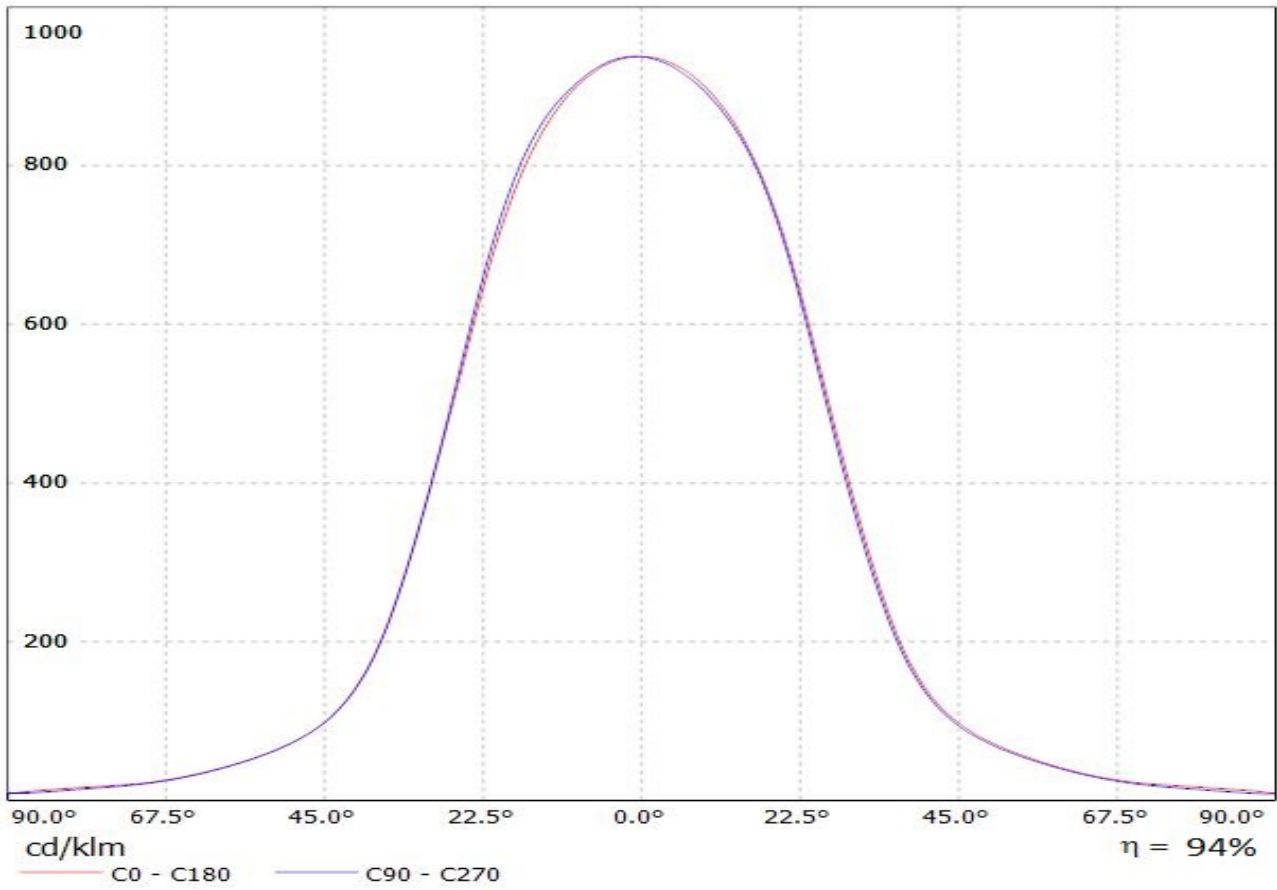

Luminaire: Ledil Oy C12361_HB-2X2-W_(Luxeon_3030_2D)_SIMULATED
Lamps: 1 x Lumileds Luxeon 3030 2D

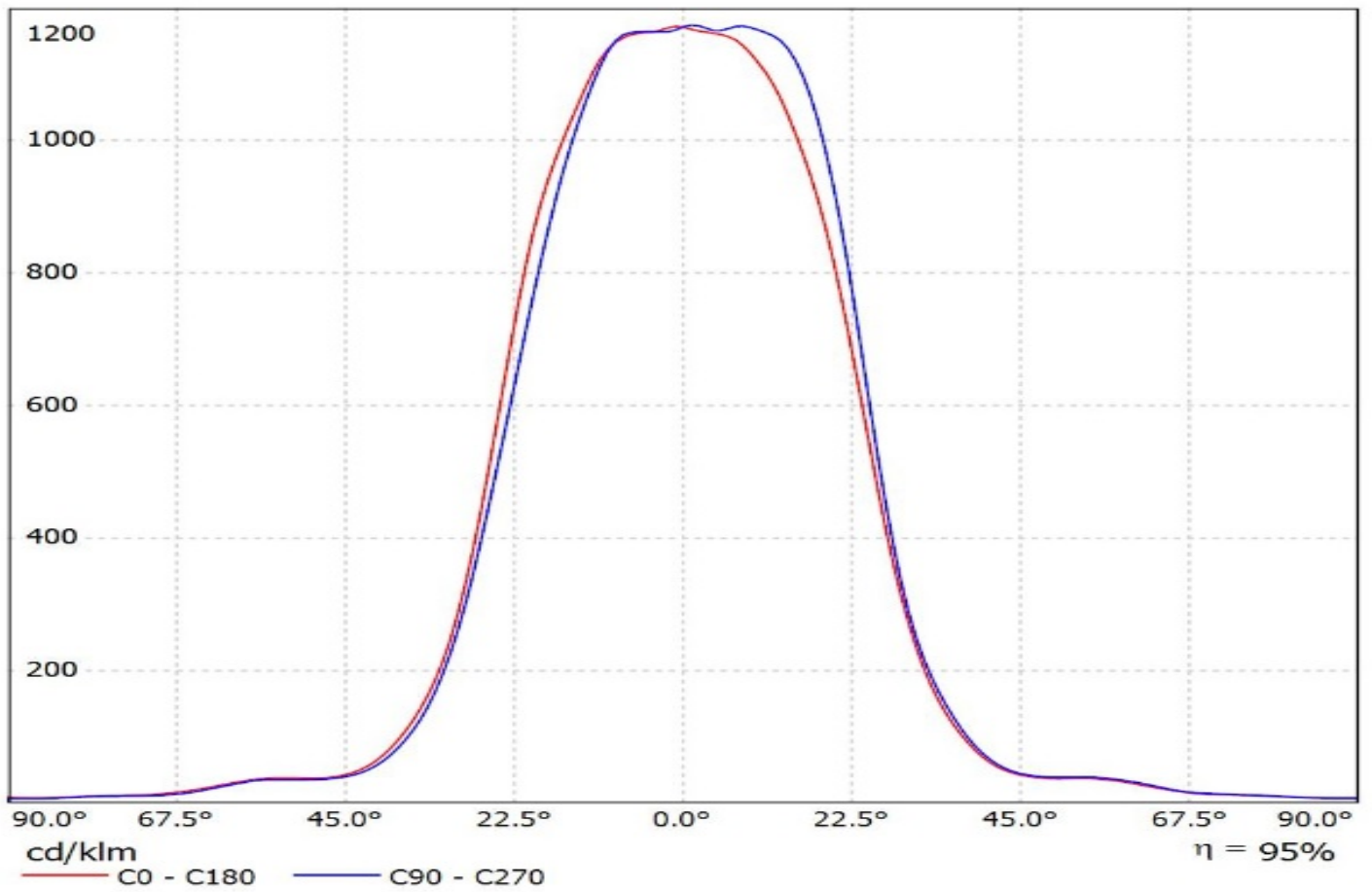

Luminaire: Ledil Oy C12361_HB-2X2-W_(Luxeon_3535L)_SIMULATED
Lamps: 1 x Lumileds Luxeon 3535L

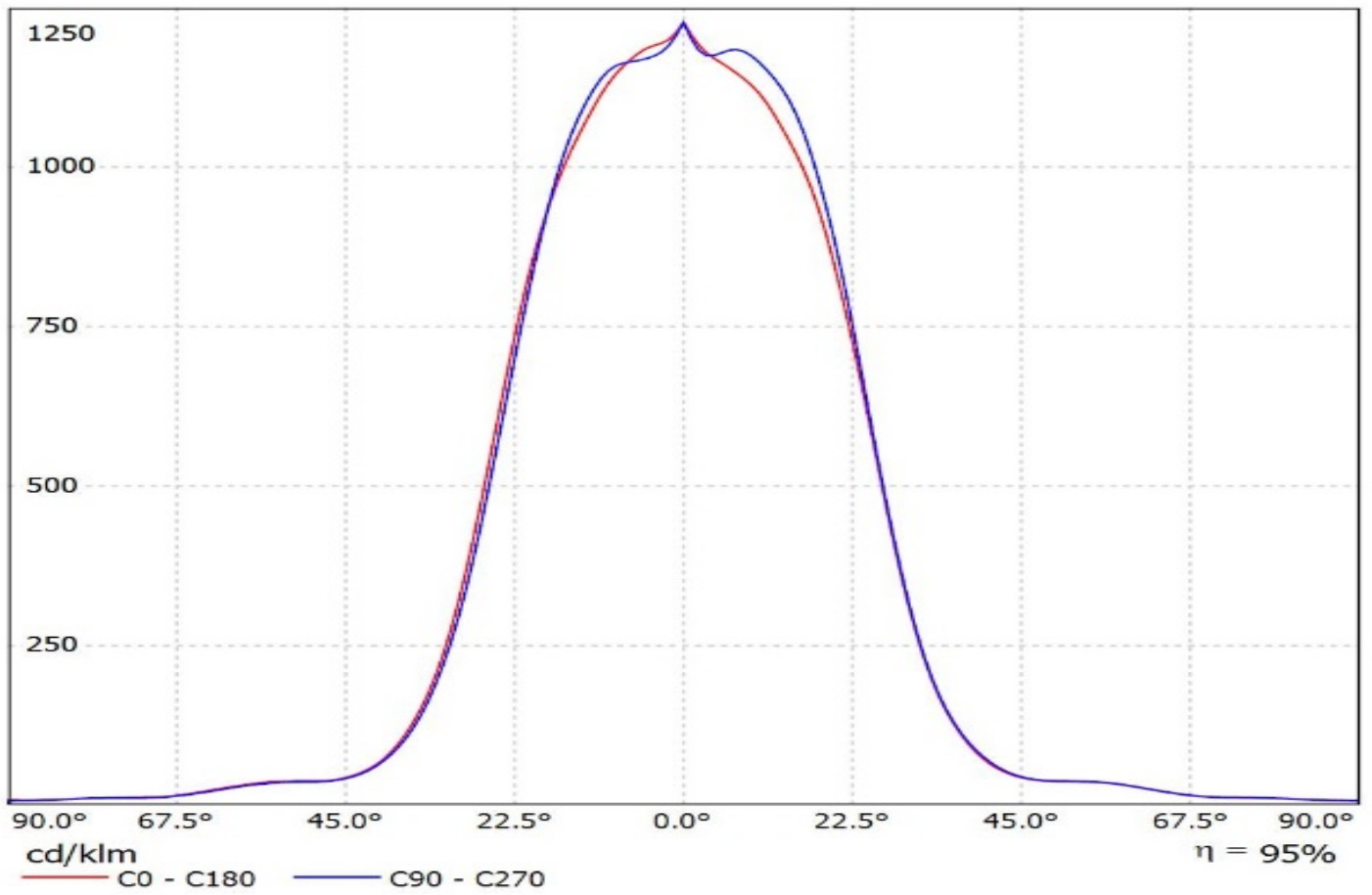

Luminaire: LEDil Oy C12361_HB-2x2-W_(NCSxx19A) Efficiency=85%
Lamps: 1 x Nichia NCSL119AT-H1) 229lm @ 250mA CCT=2800K P=3.1W I=250mA

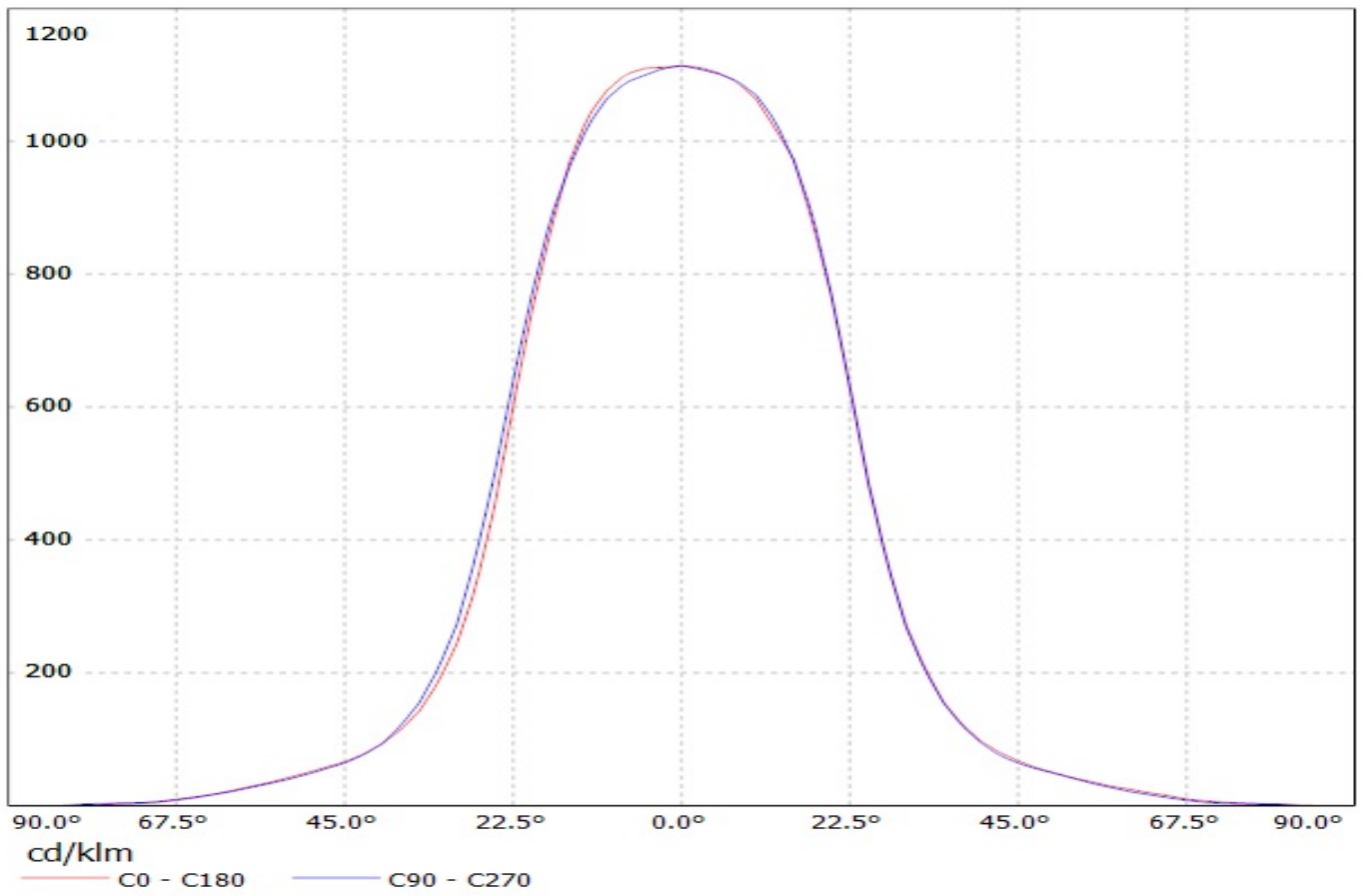

Luminaire: LEDiL Oy C12361_HB-2X2-W_(NS9x383) Eff. 86%
Lamps: 1 x Nichia NS9x383 (288lm@250mA)

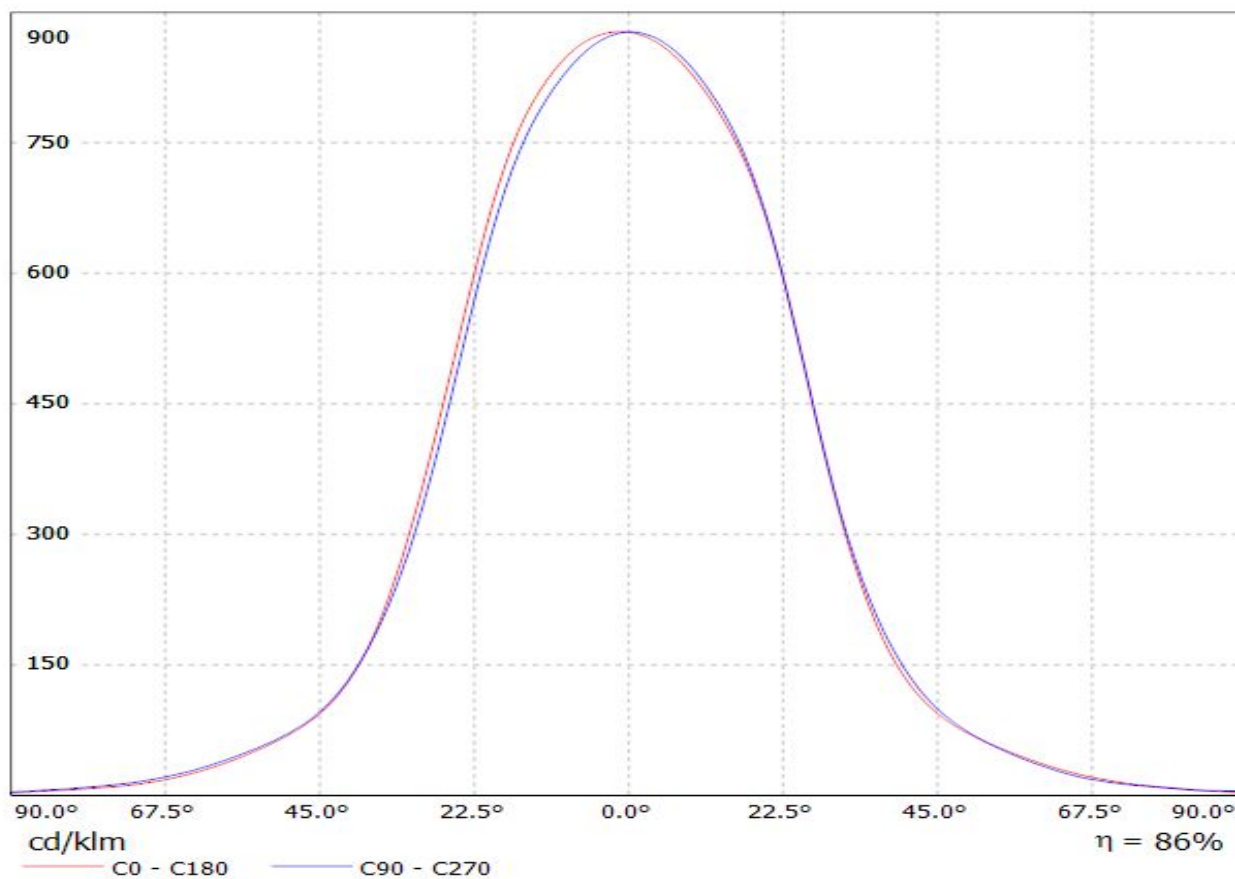

Luminaire: Ledil Oy C12361_HB-2X2-W_(NVS19B) Efficiency=85%
Lamps: 1 x Nichia NVS19B (NVSL219BE) 308lm @ 250mA CCT= P=2.89W I=250mA

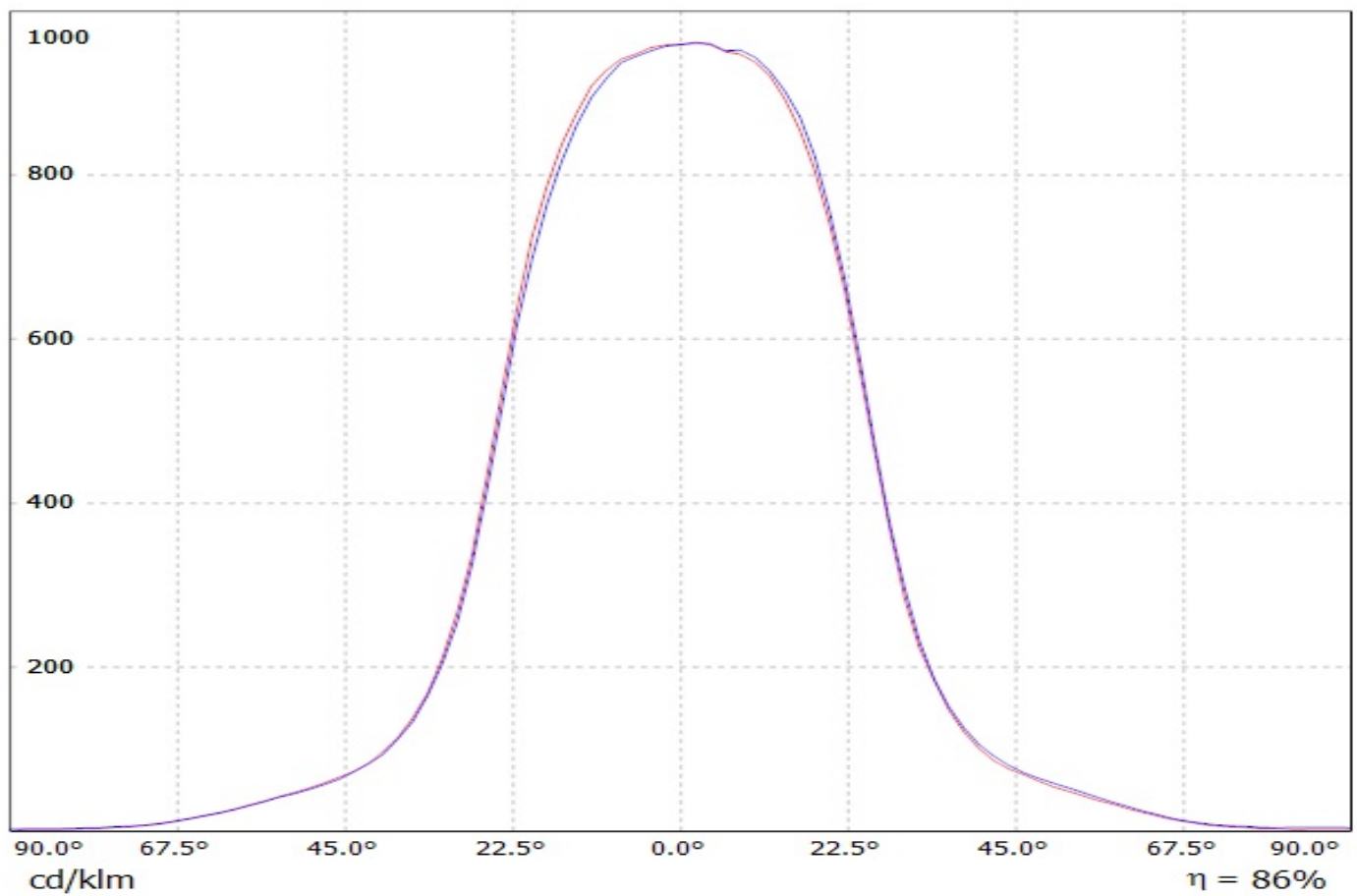

Luminaire: LEDil Oy C12361_HB-2x2-W_(NCSxx19B) Efficiency=85%
Lamps: 1 x Nichia NCSxx19b (NCSW119BE) 425lm @ 250mA CCT=5400K P=3.1W I=250mA

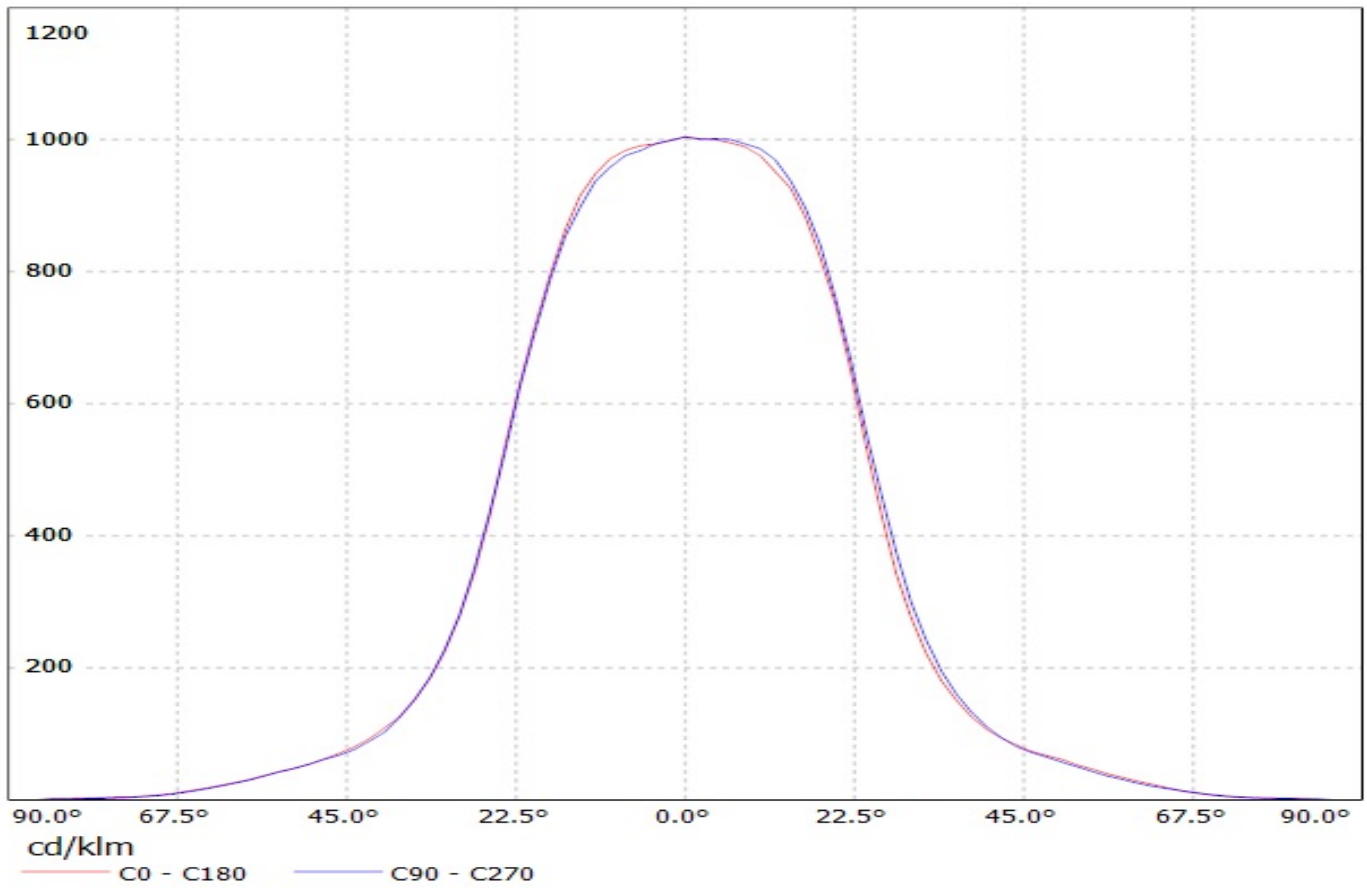

Luminaire: LEDiL Oy C12361_HB-2X2-W_(NWSL229AE)

Lamps: 1 x Nichia_2X2_NWSL229AE_476.548lm@250mA_P=2.7515W_I=0.250A

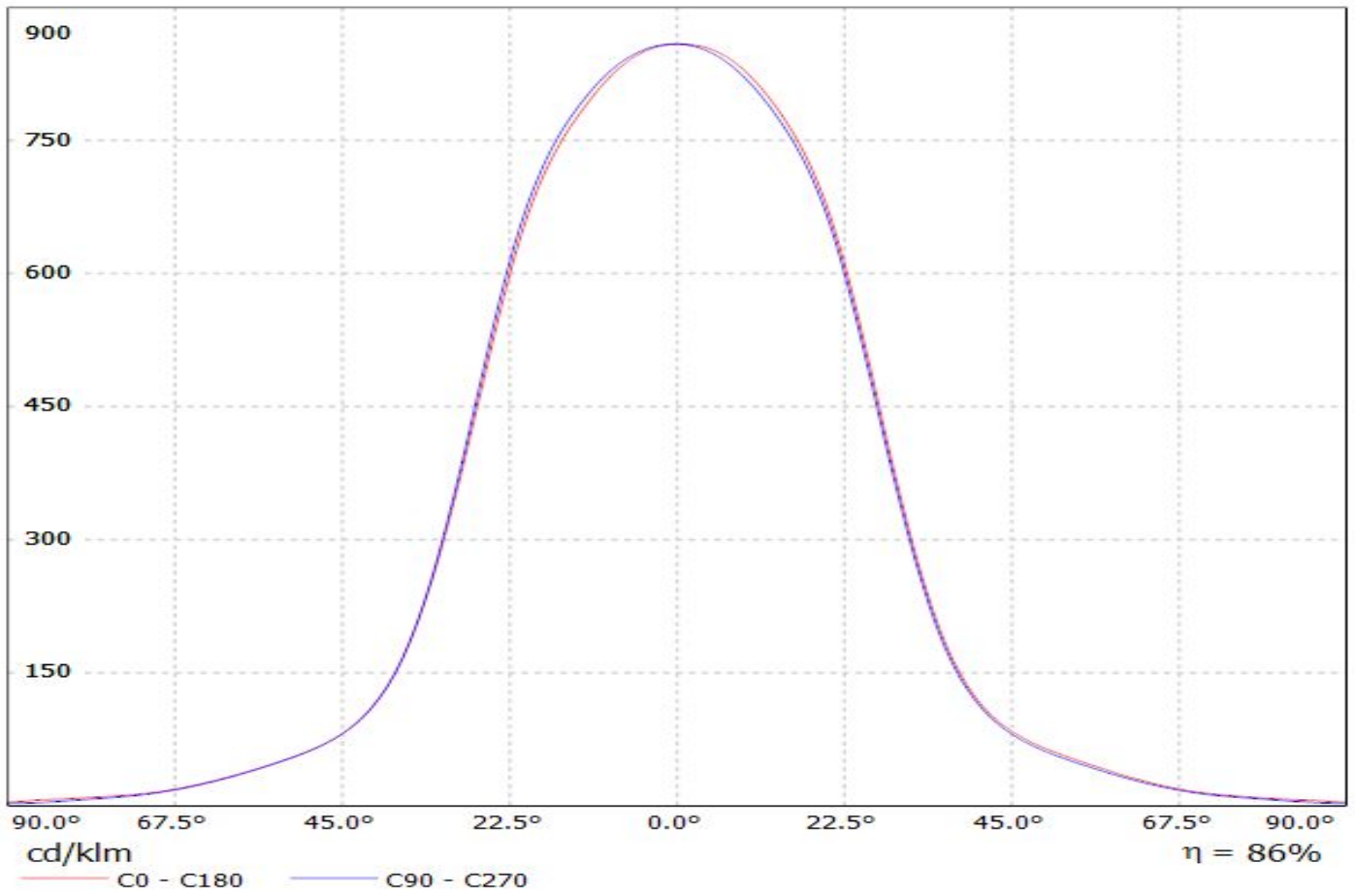

Luminaire: LEDiL Oy C12361_HB-2X2-W_(NVSW3x9A)

Lamps: 1 x Nichia_NVSW3x9A_(sm405/R70)_483.482lmP=2.75904W_I=0.250A

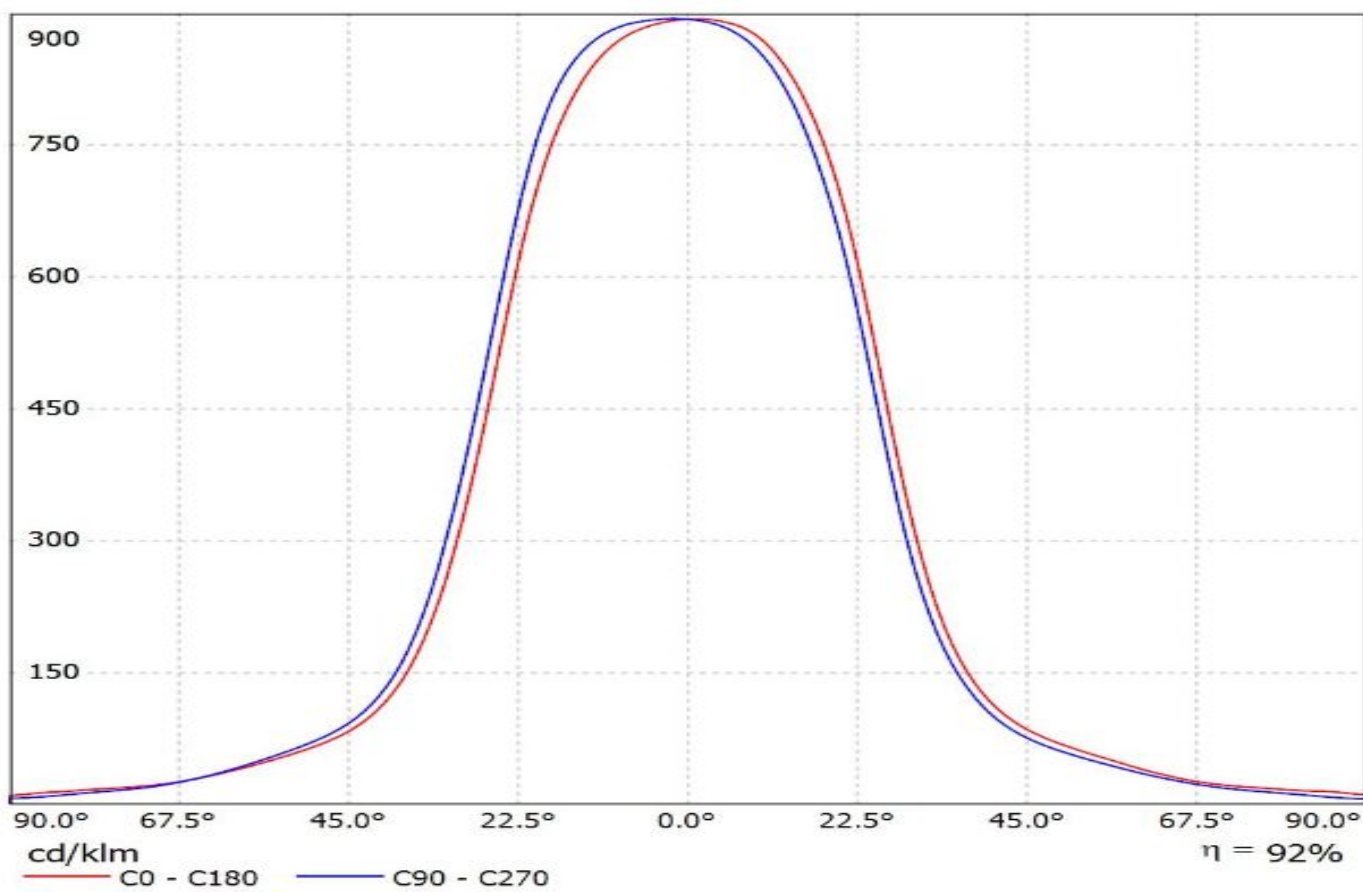

Luminaire: LEDiL Oy C12361_HB-2X2-W_(E21A)
Lamps: 1 x Nichia_E21A_2X2_454.11lm@250mA_P=2.81W_I=0.250A

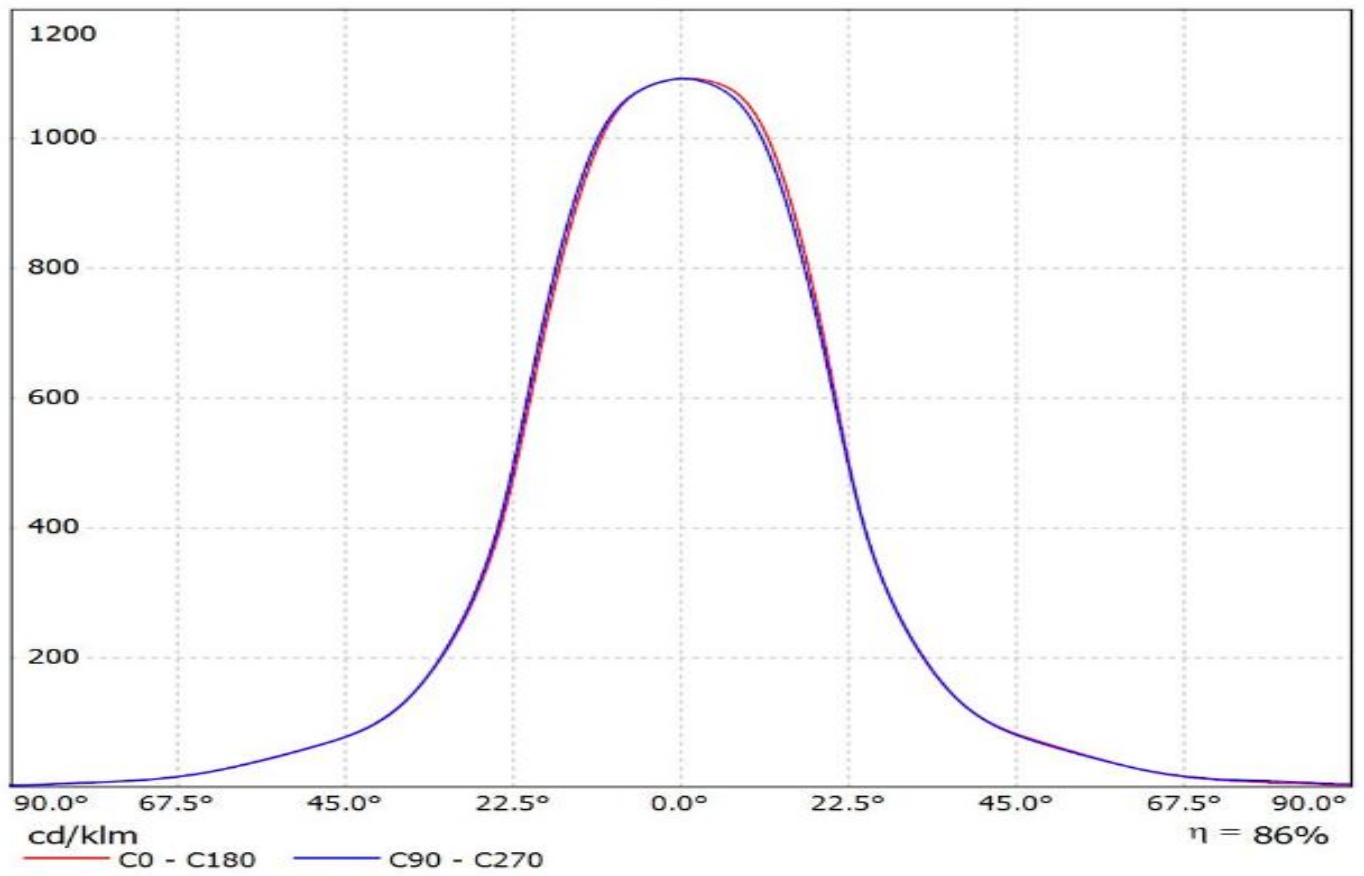

Luminaire: LEDiL Oy C12361_HB-2X2-W_(OLP-5065F6L-06A) Eff.88.5%
Lamps: 1 x OPTOGAN_2x2_(OLP-5065F6L-06A-80-D05O0) 423.091lm@250mA CCT=5000K P=2.98506W I=249.9mA

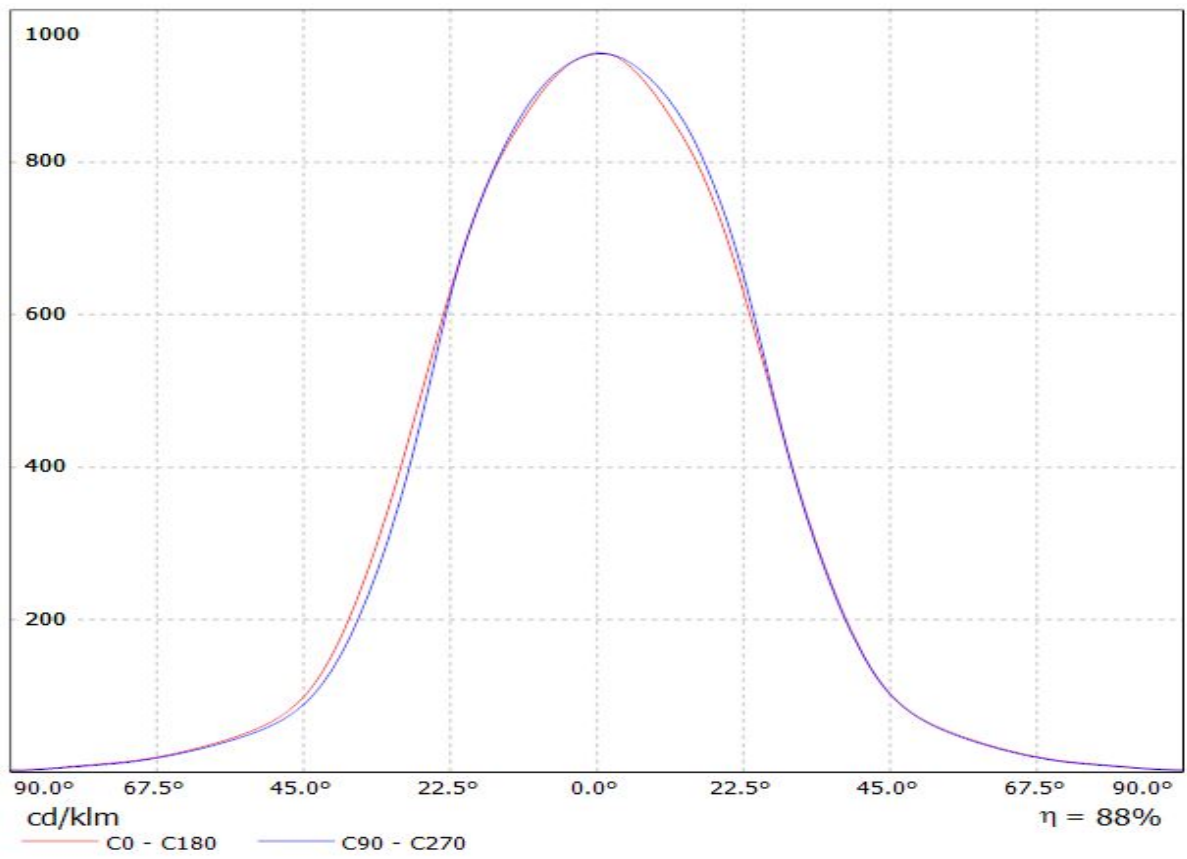

Luminaire: LEDIL OY C12361_HB-2X2 (SSL80) Efficiency=89%
Lamps: 1 x Osram SSL80 (340lm @ 250mA)

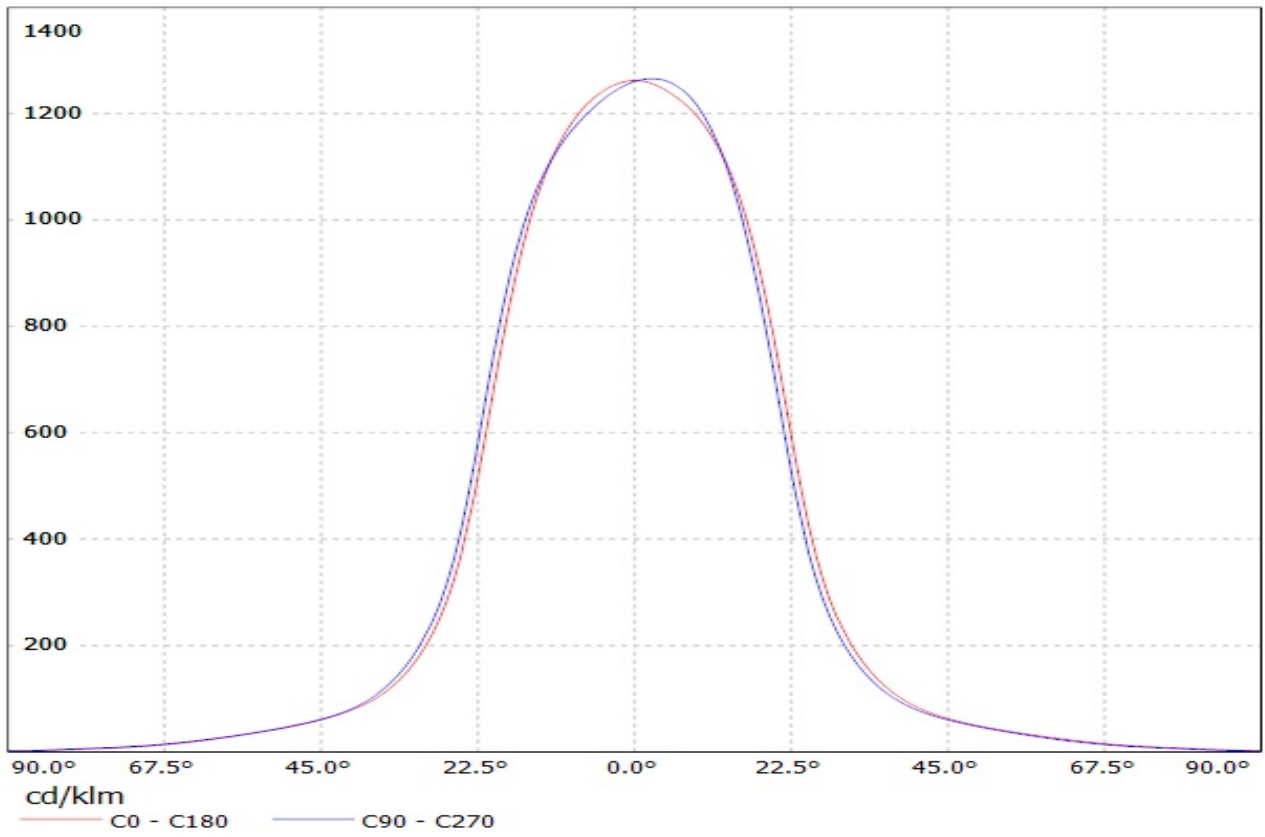

Luminaire: LEDIL OY C12361_HB-2X2_(SQ_PC) Efficiency=87%
Lamps: 1 x OSLO SQUARE PC (400.6lm)

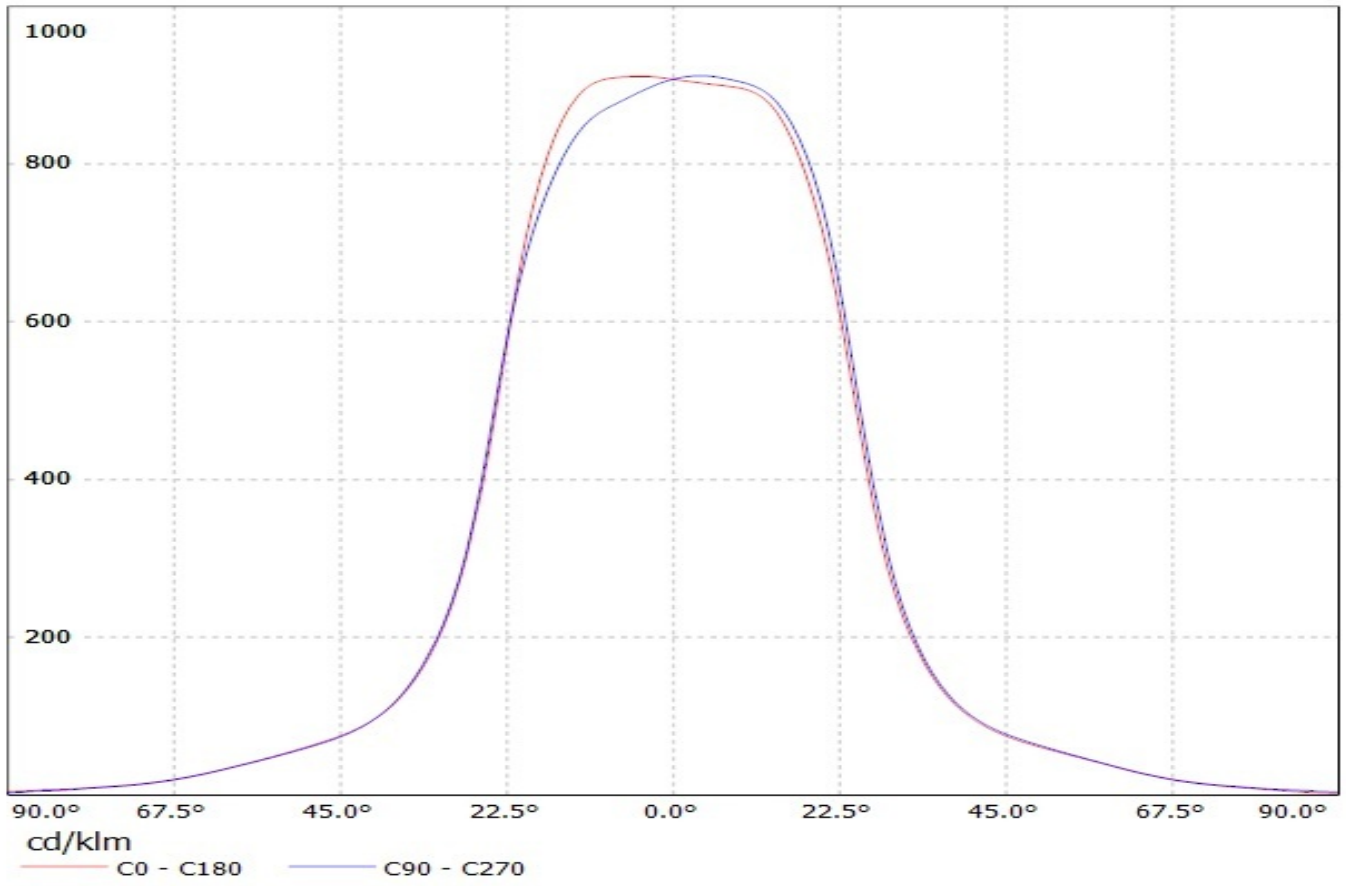

Luminaire: Ledil Oy C12361_HB-2X2-W_(Duris_P8)_SIMULATED
Lamps: 1 x Osram Duris P8

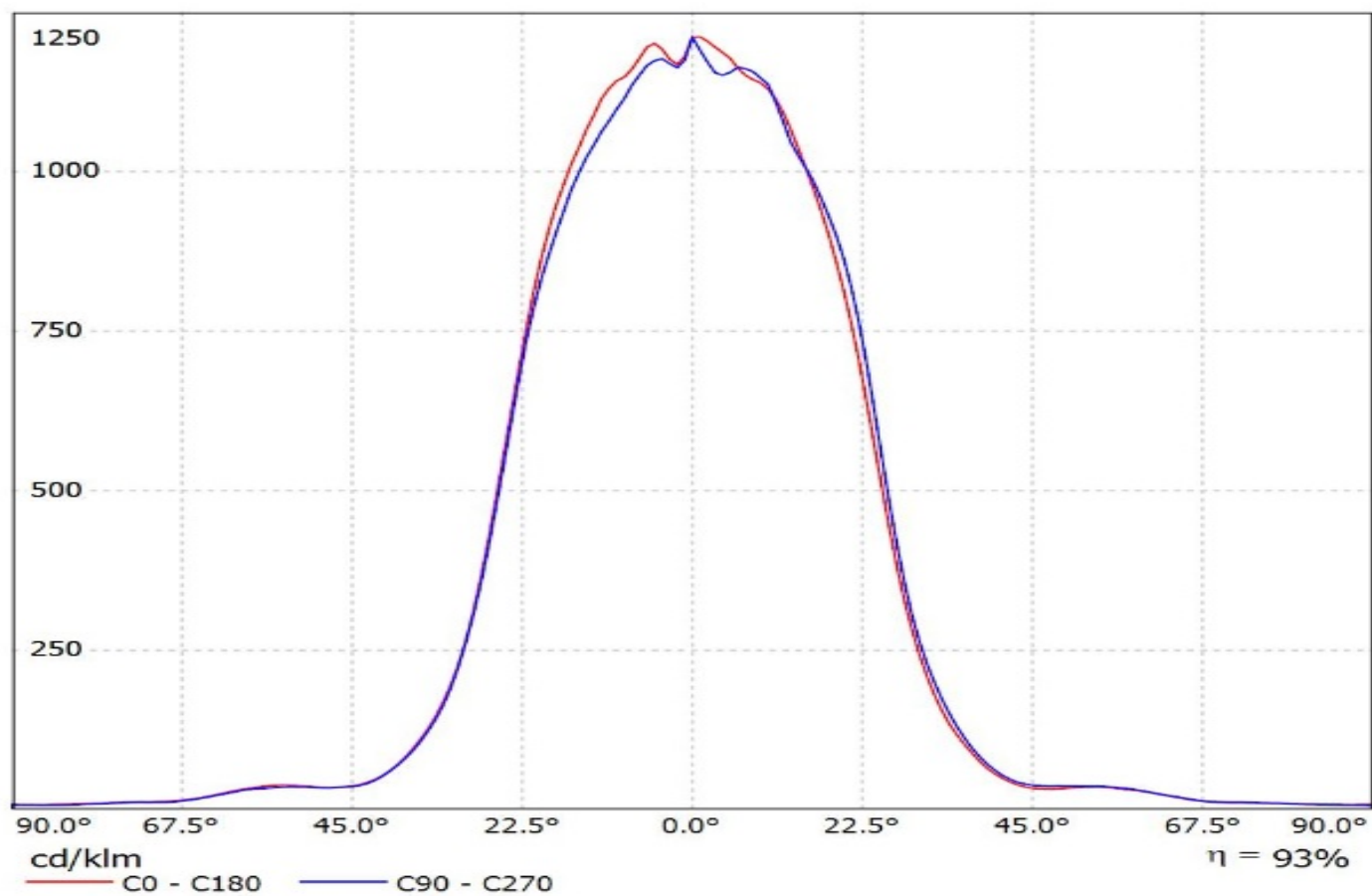

Luminaire: Ledil C12361_HB-2X2-W_(Fortimo_FastFlex_LED_board_2x8/740_DA_G3)
Lamps: 1 x Fortimo_FastFlex_LED_board_2x8/740_DA_G3_1828.23lm@250mA_P=11.667W_I=0.25A

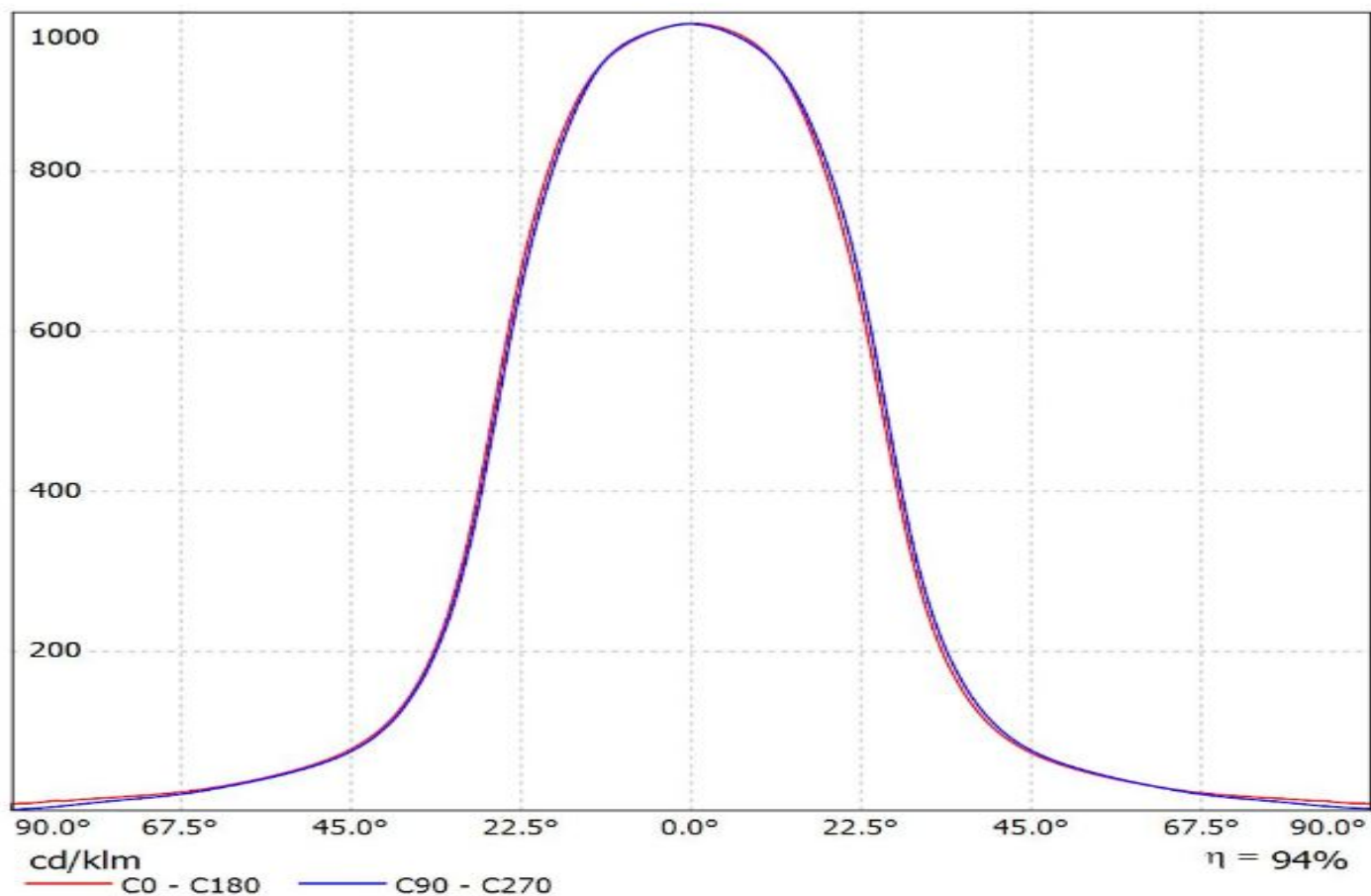

Luminaire: Ledil Oy C12361_HB-2X2-W_(Fortimo_FastFlex_LED_board_2x8_DAX_G4)_SIMULATED
Lamps: 1 x C12361_HB-2X2-W_(Fortimo_FastFlex_LED_board_2x8_DAX_G4)_SIMULATED

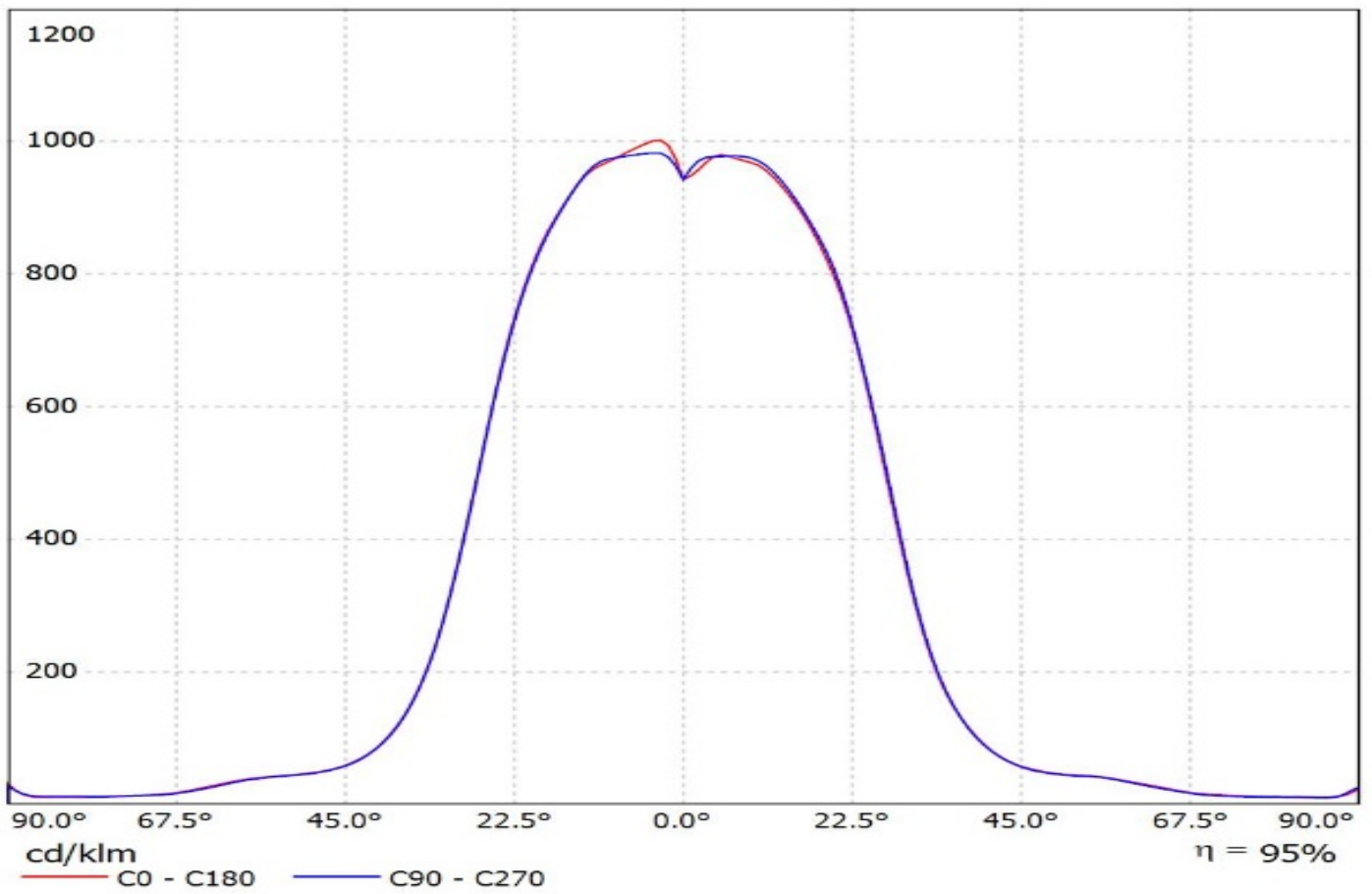

Luminaire: LEDIL OY C12361_HB-2X2 (3535) Efficiency=89%
Lamps: 1 x SAMSUNG 3535 (353lm @ 250mA)

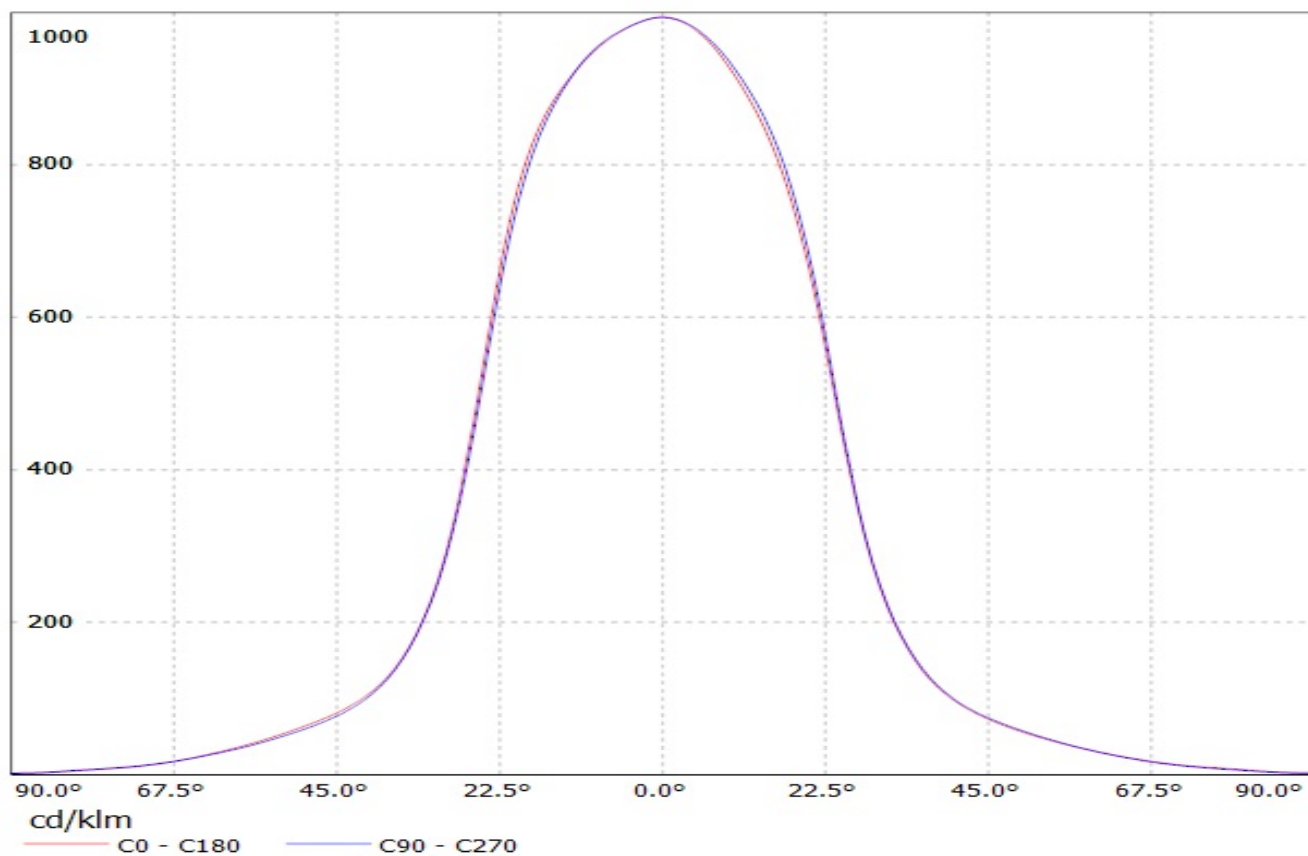

Luminaire: LEDiL Oy C12361_HB-2X2-W_(LH351Z) Eff.87.4%
Lamps: 1 x SAMSUNG_LH351Z_2x2_359.49lm@250mA_P=2.86371W_I=249.8mA

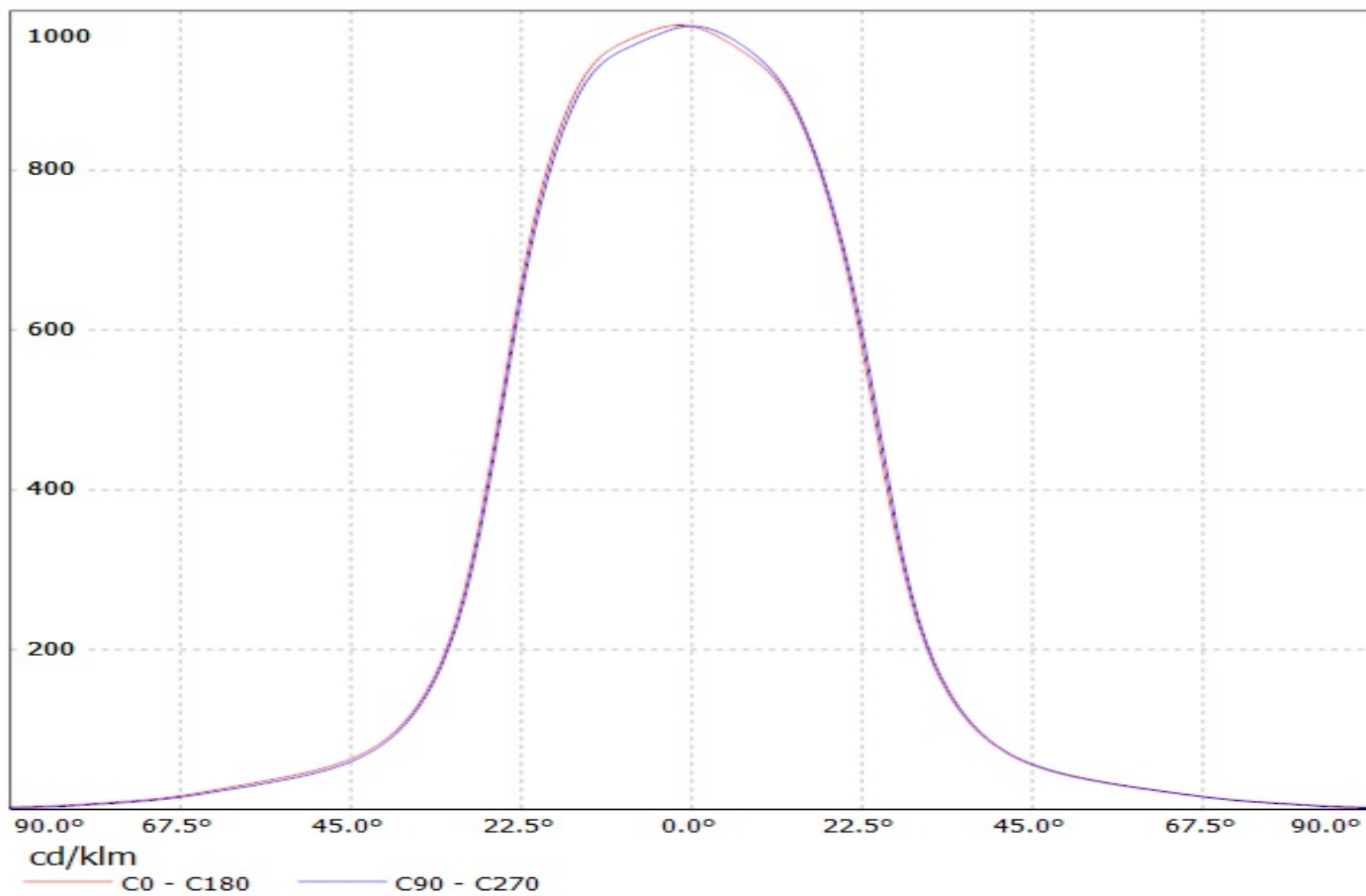

Luminaire: Ledil C12361_HB-2X2-W_(LH351B)

Lamps: 1 x Samsung_LH351B_2x2_444.178lm@250mA_P=2.8535W_I=0.25A

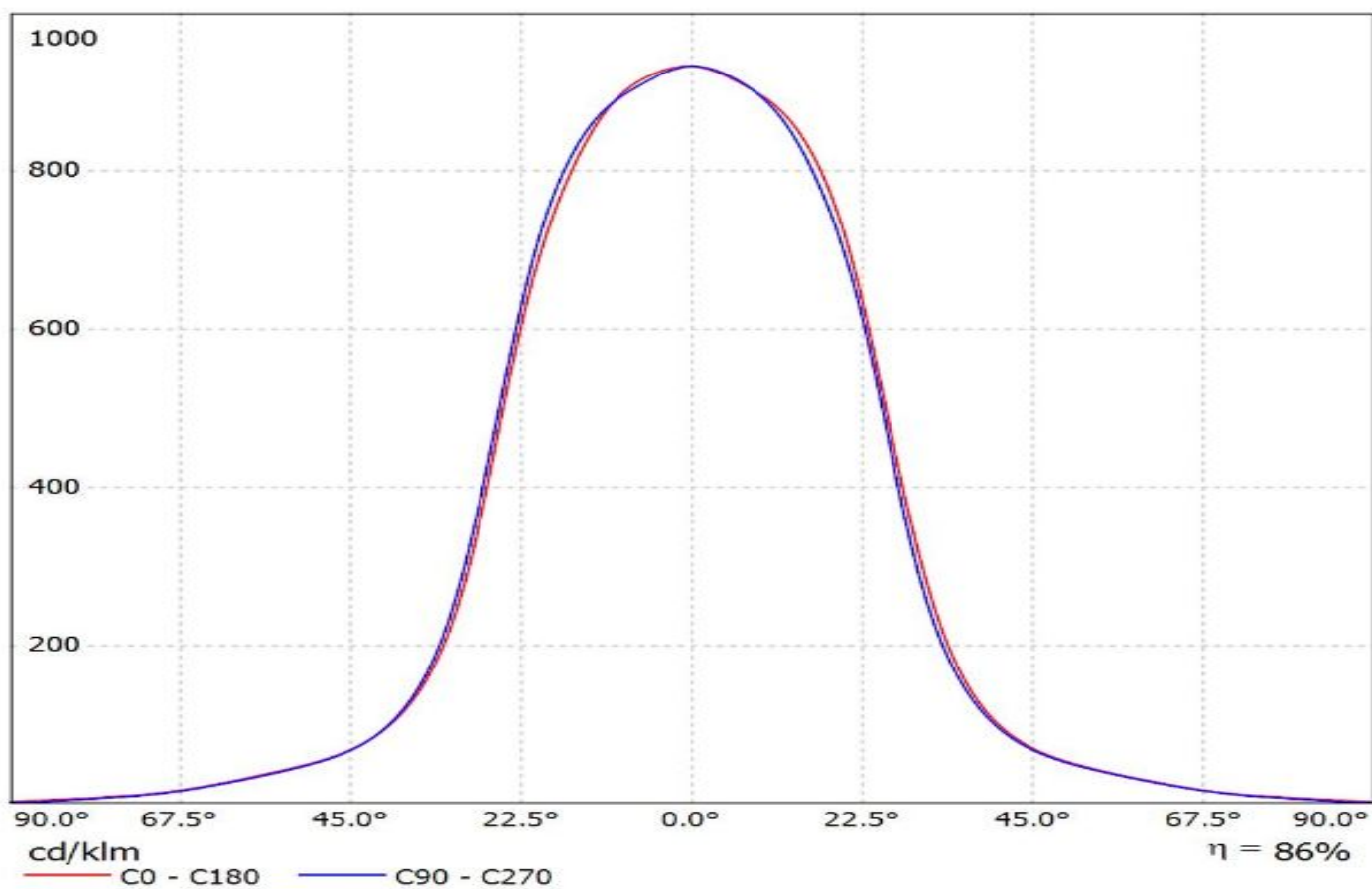

Luminaire: Ledil C12361_HB-2X2-W_(LH351D)

Lamps: 1 x Samsung_LH351D_536.957lm@250mA_P=2.7695W_I=0.250A

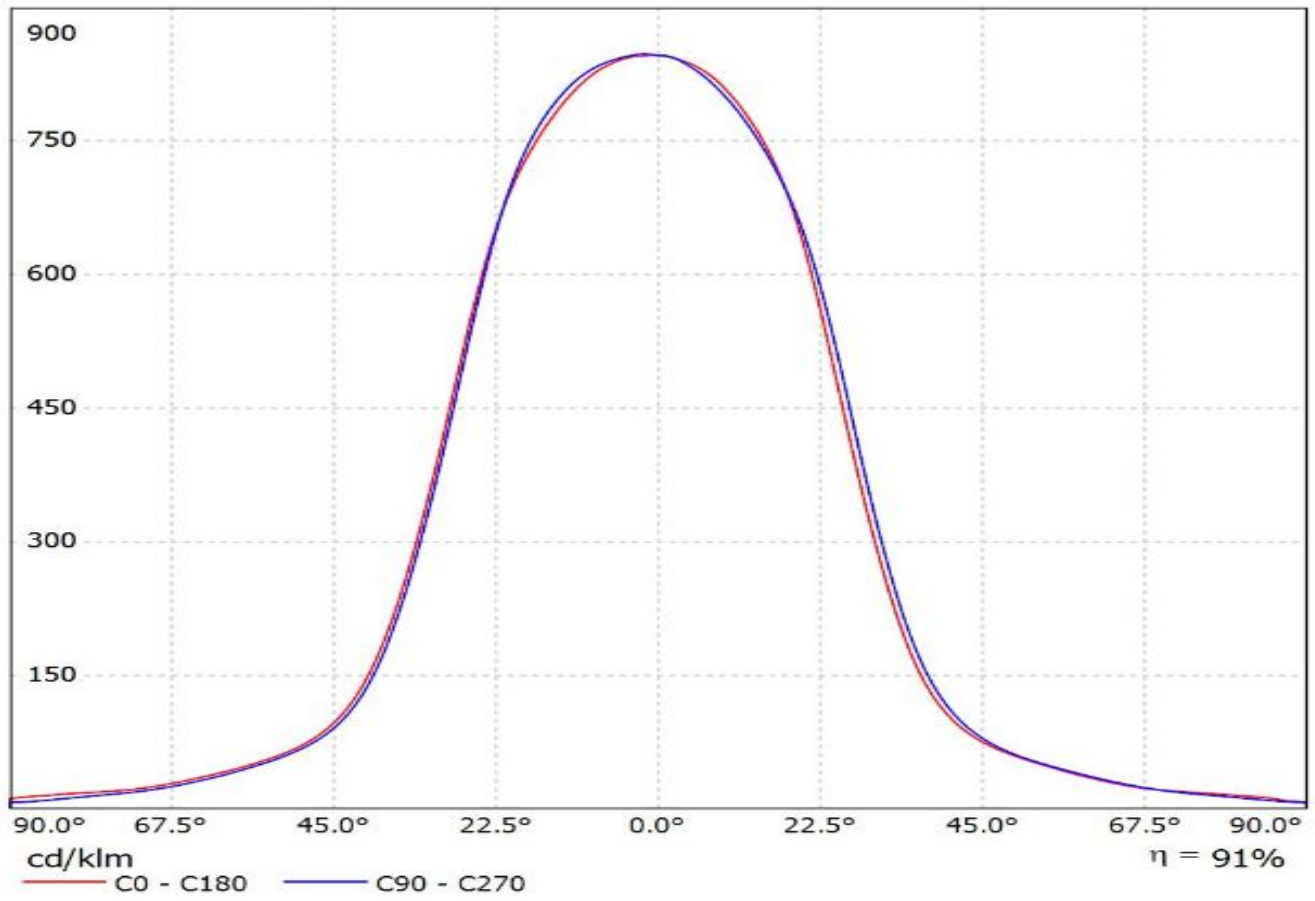

Luminaire: Ledil C12361_HB-2X2-W_(LH351C)
Samsung_LH351C_518.223lm@250mA_P=2.85225W_I=0.25A
Lamps: 1 x Samsung_LH351C_518.223lm@250mA_P=2.85225W_I=0.25A

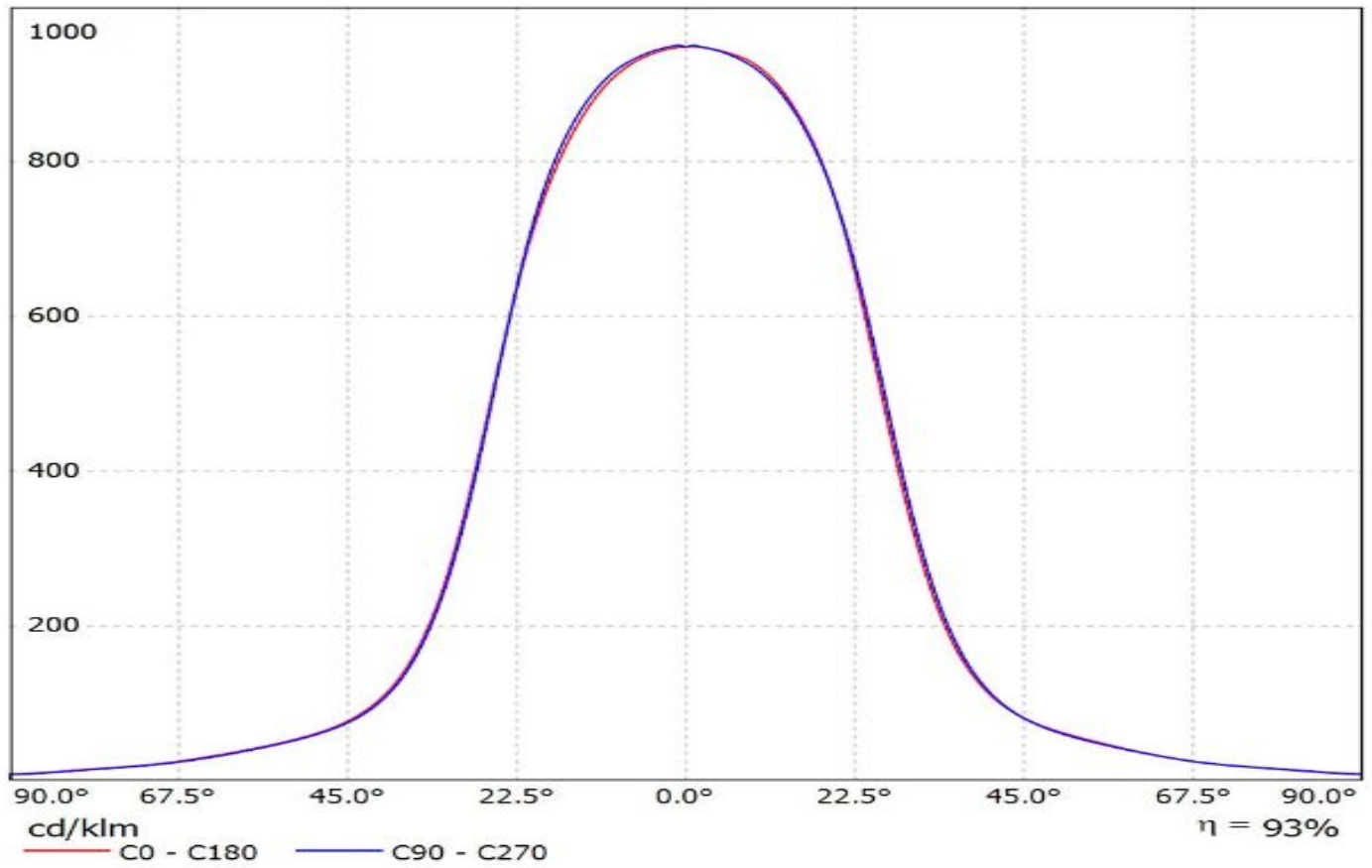

Luminaire: Ledil C12361_HB-2X2-W_(LH508A)

Lamps: 1 x Samsung_LH508A_2x2_2060.04lm@160mA_CCT=5000K_CRI=80_P=15.5405W_I=0.16A

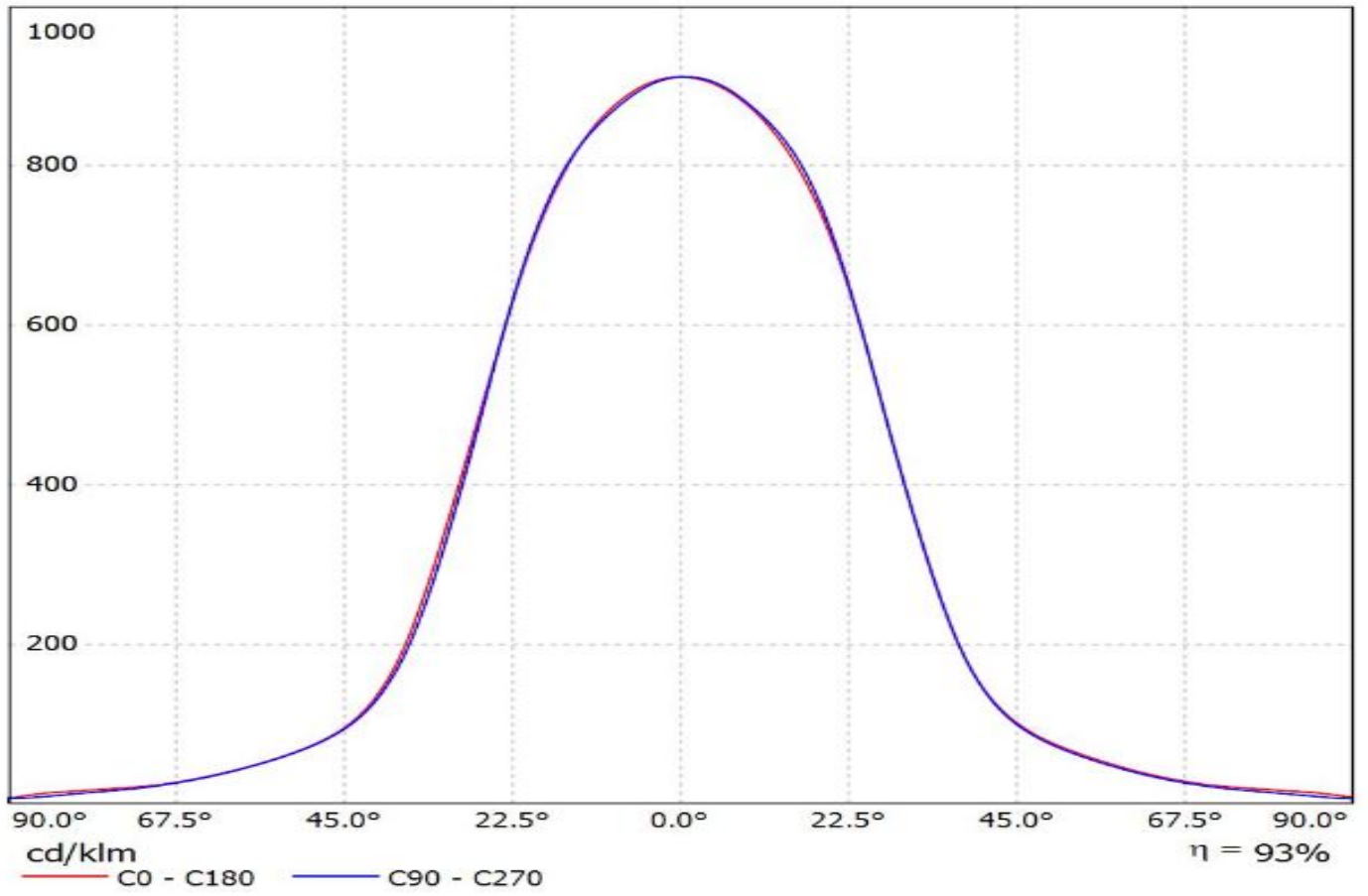

Luminaire: LEDIL OY C12361_HB-2X2 (Z5) Efficiency=88%
Lamps: 1 x Seoul Z5 (290lm @ 250mA)

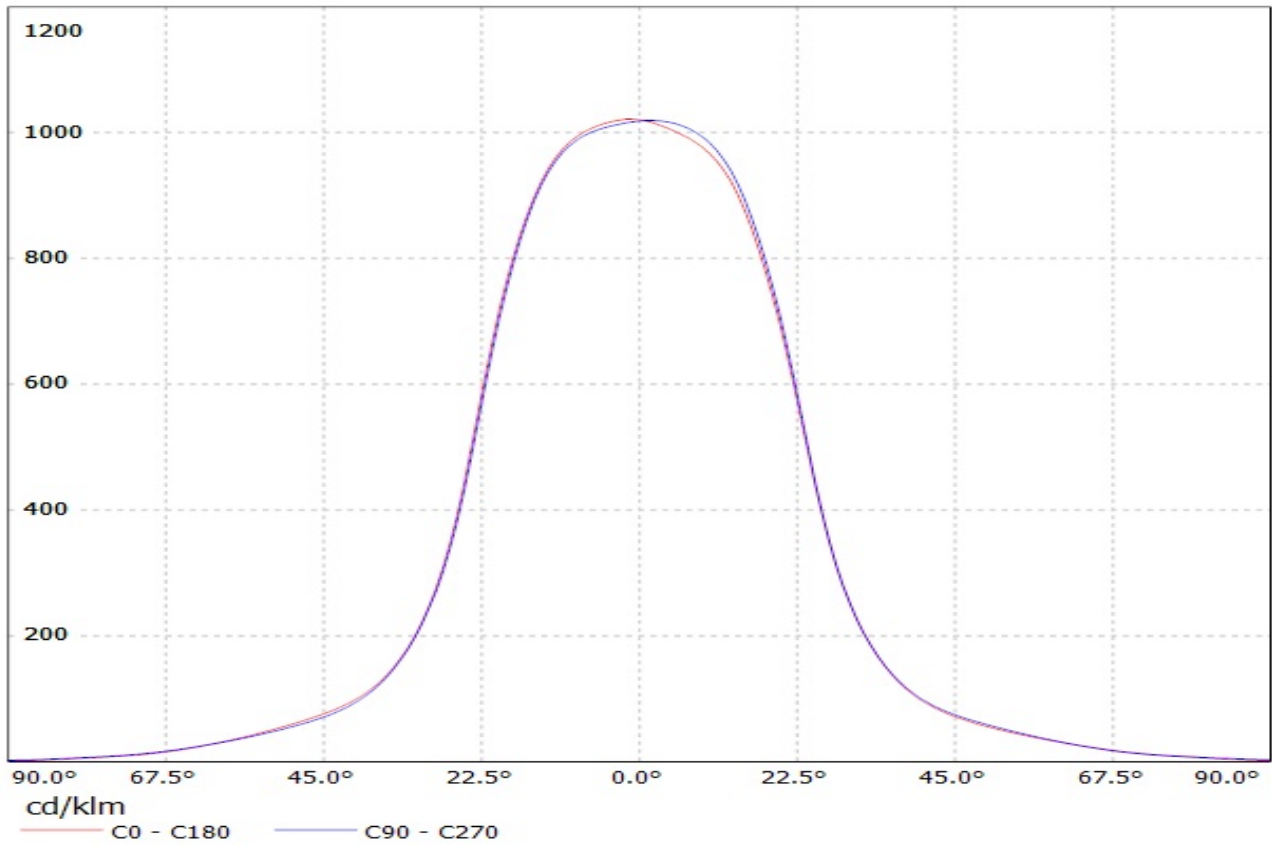

Luminaire: LEDil Oy C12361_HB-2X2-W_(Z5M1) Efficiency=85%
Lamps: 1 x Seoul Z5M1 (SZ5-M1-WN-C8) 379lm @ 250mA CCT=4600K P=2.9W I=250mA

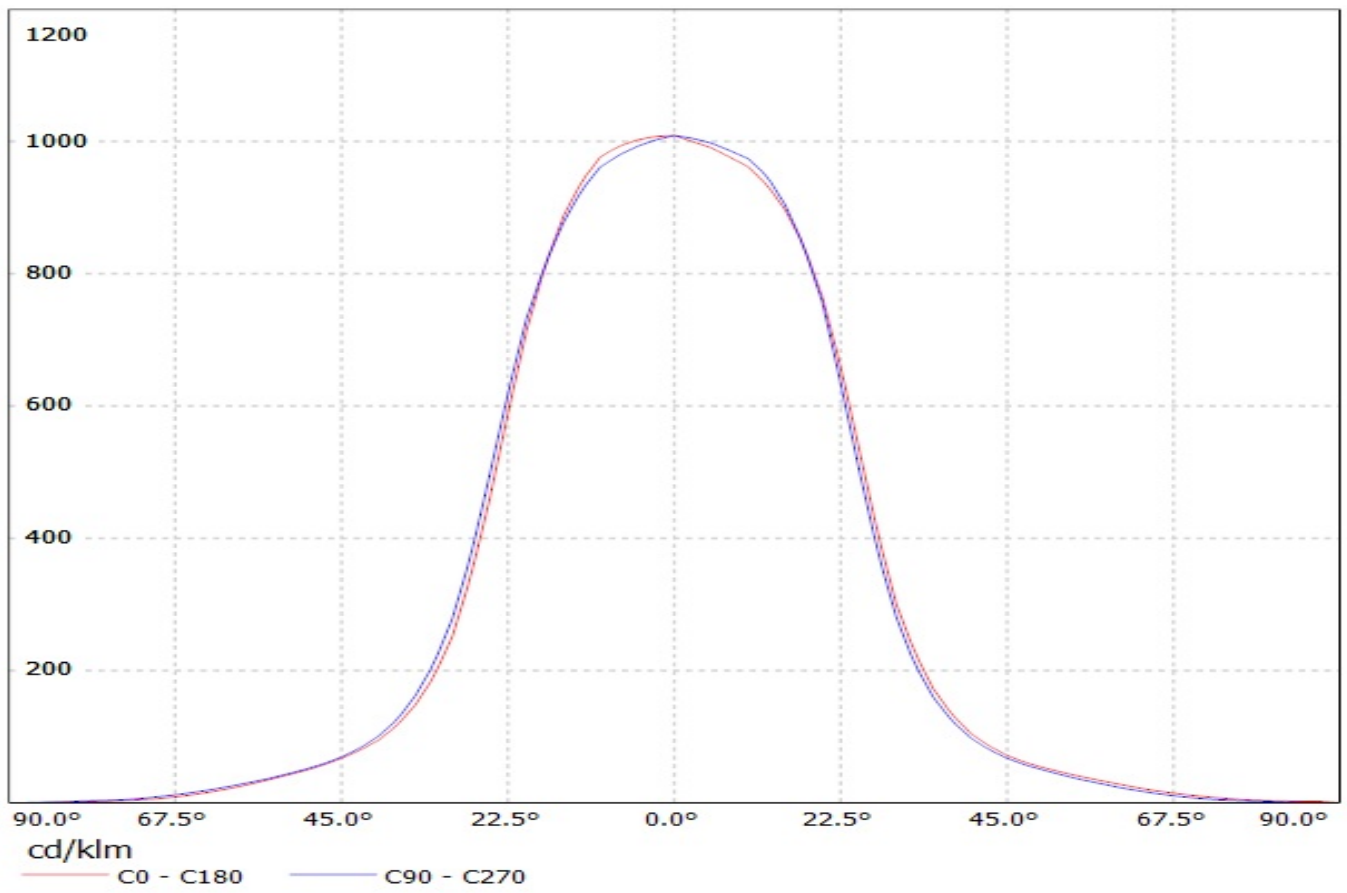

Luminaire: LEDiL Oy C12361_HB-2X2-W_(WICOP2_Z8Y15)
Lamps: 1 x SEOUL_WICOP2_Z8Y15_336.842lm@250mA_P=2.9399W_I=0.250A

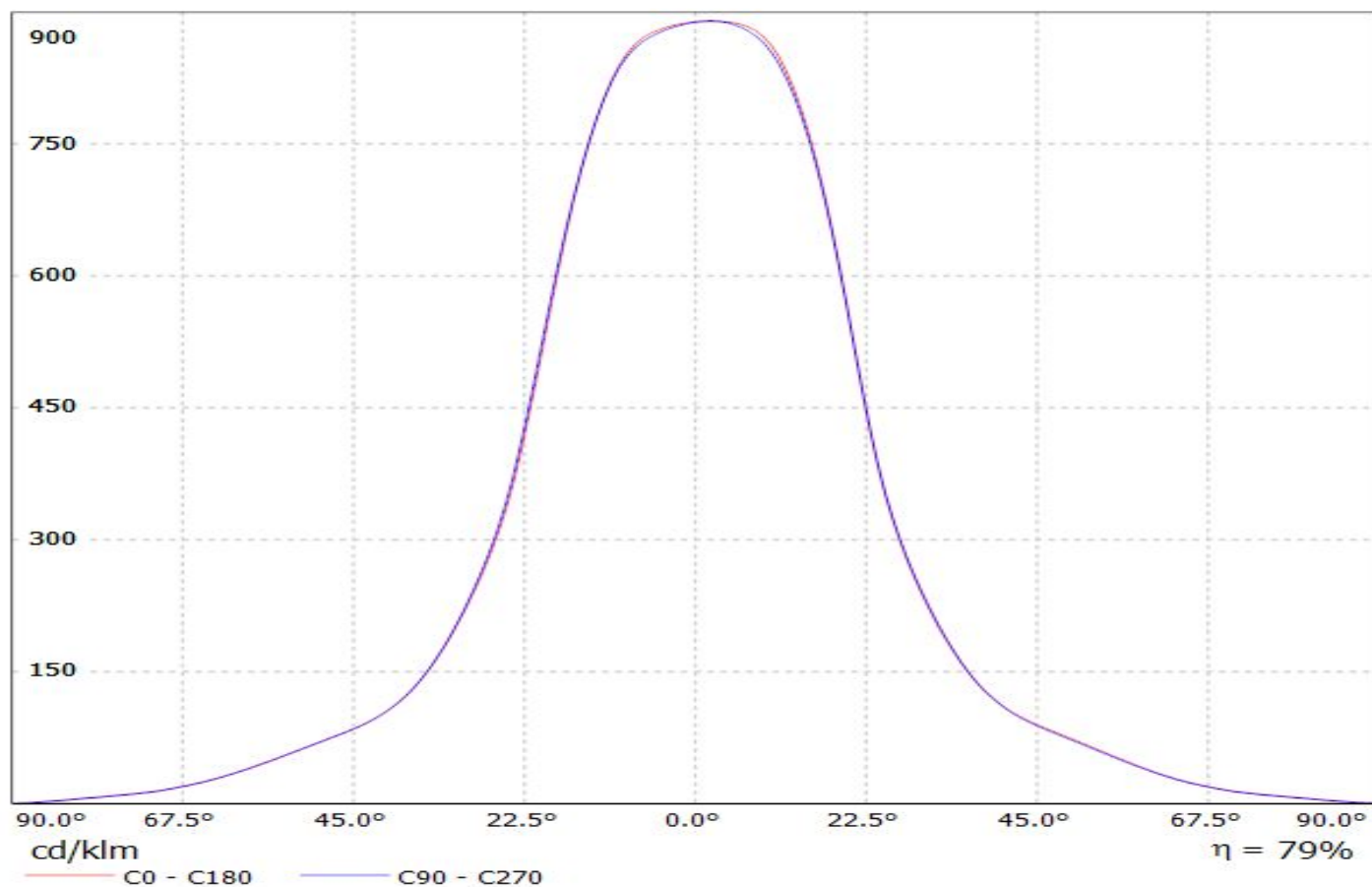

Luminaire: LEDiL Oy C12361_HB-2X2-W_(WICOP2_Z8Y19)

Lamps: 1 x SEOUL_WICOP2_Z8Y19_450.124lm@250mA_P=2.8579W_I=0.250A

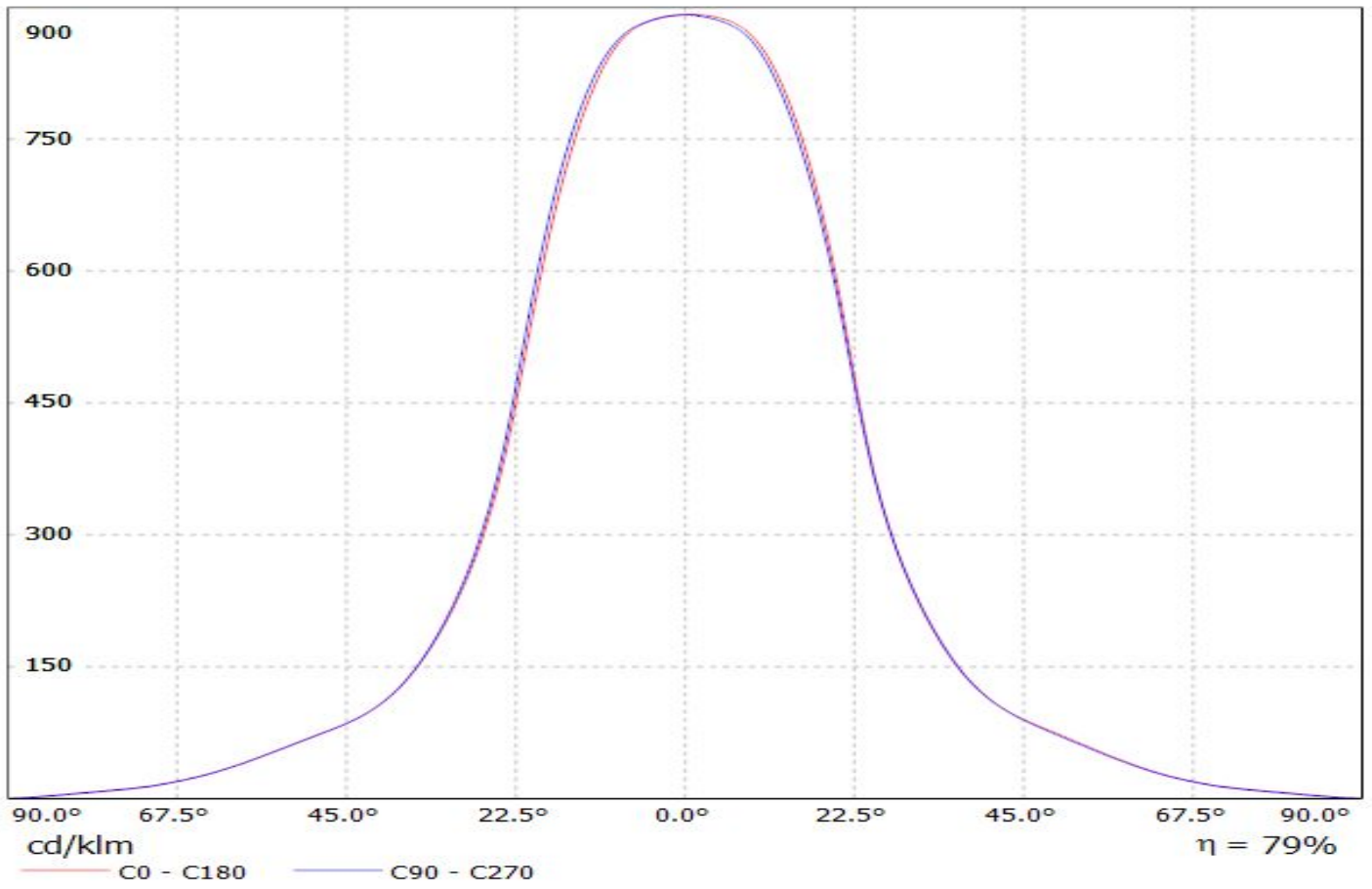

Luminaire: Ledil Oy C12361_HB-2X2-W_(Z5M2)_SIMULATED
Lamps: 1 x Seoul Z5M2 (SZ5-M2-W0-00)

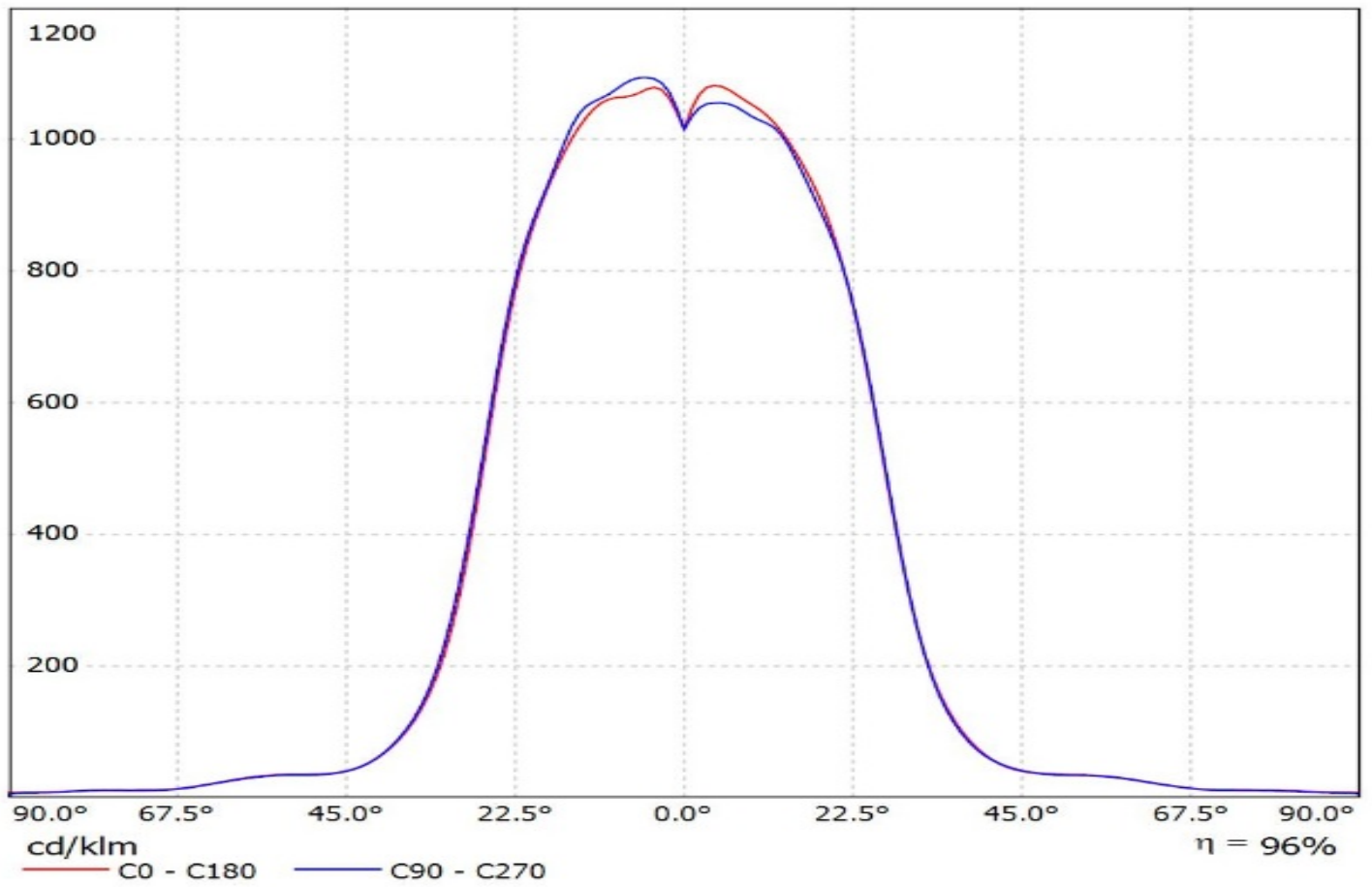

Luminaire: Ledil C12361_HB-2X2-W_(Z8Y22plus)

Lamps: 1 x Seoul_Z8Y22plus_(W6E2G)_513.996lm@250mA_P=2.754W_I=0.250A

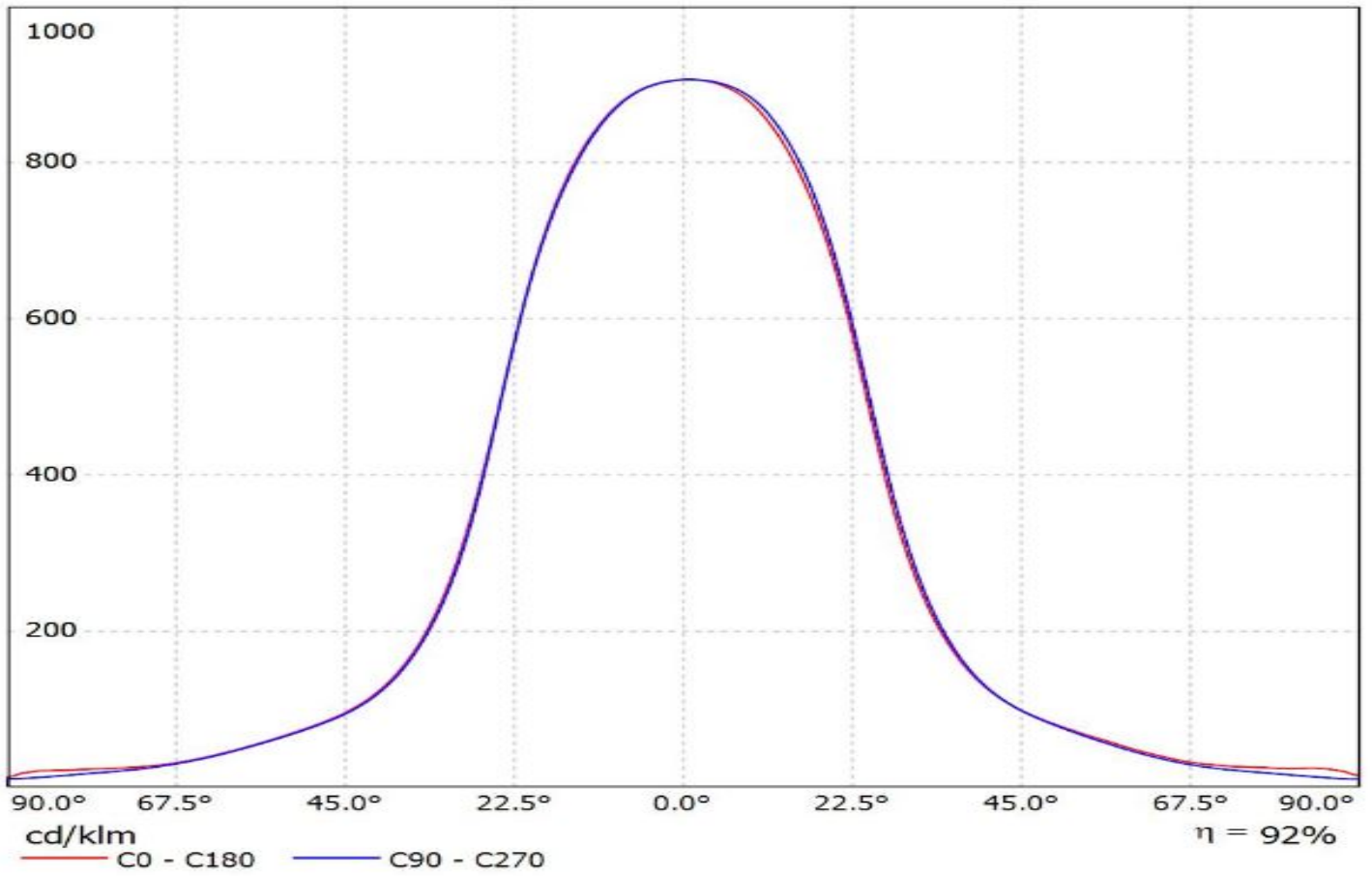

Luminaire: Ledil Oy C12361_HB-2X2-W_(Acrich_MJT_4040)_SIMULATED
Lamps: 1 x Seoul Acrich MJT 4040

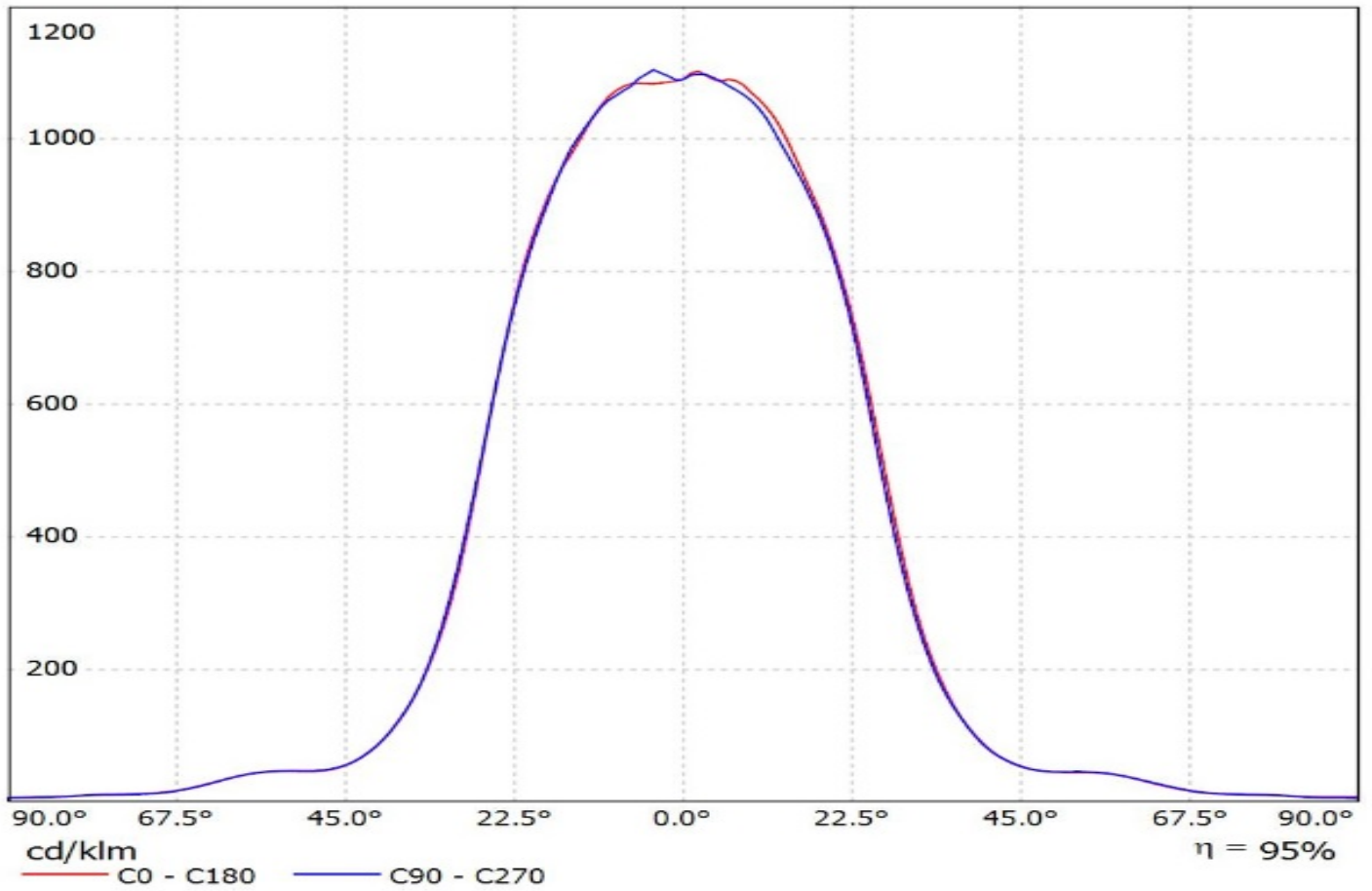

Ledil C12361_HB-2X2-W_(TL1L4) / LDC (Linear)

Luminaire: Ledil C12361_HB-2X2-W_(TL1L4)

Lamps: 1 x Toshiba_TL1L4_2x2_(TL1L4-DW0)_472.639lm@250mA_CCT=6500K_P=2.9W_I=0.25A

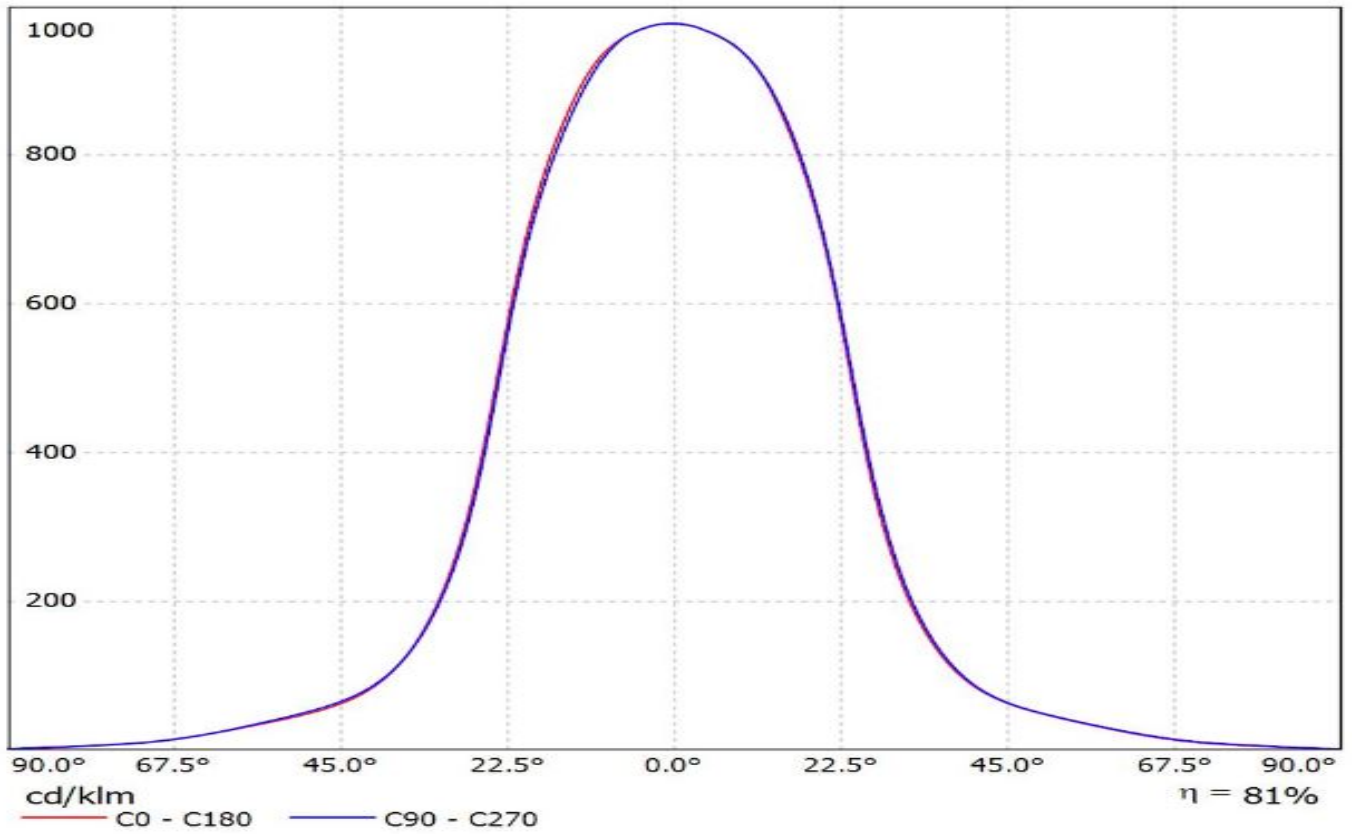

Luminaire: LEDiL Oy C12361_HB-2X2-W_(Tridonic_Module_RLE_G1)
Lamps: 1 x Tridonic_Module_RLE_G1_4576.03lm@700mA_P=32.0681W_I=0.700A

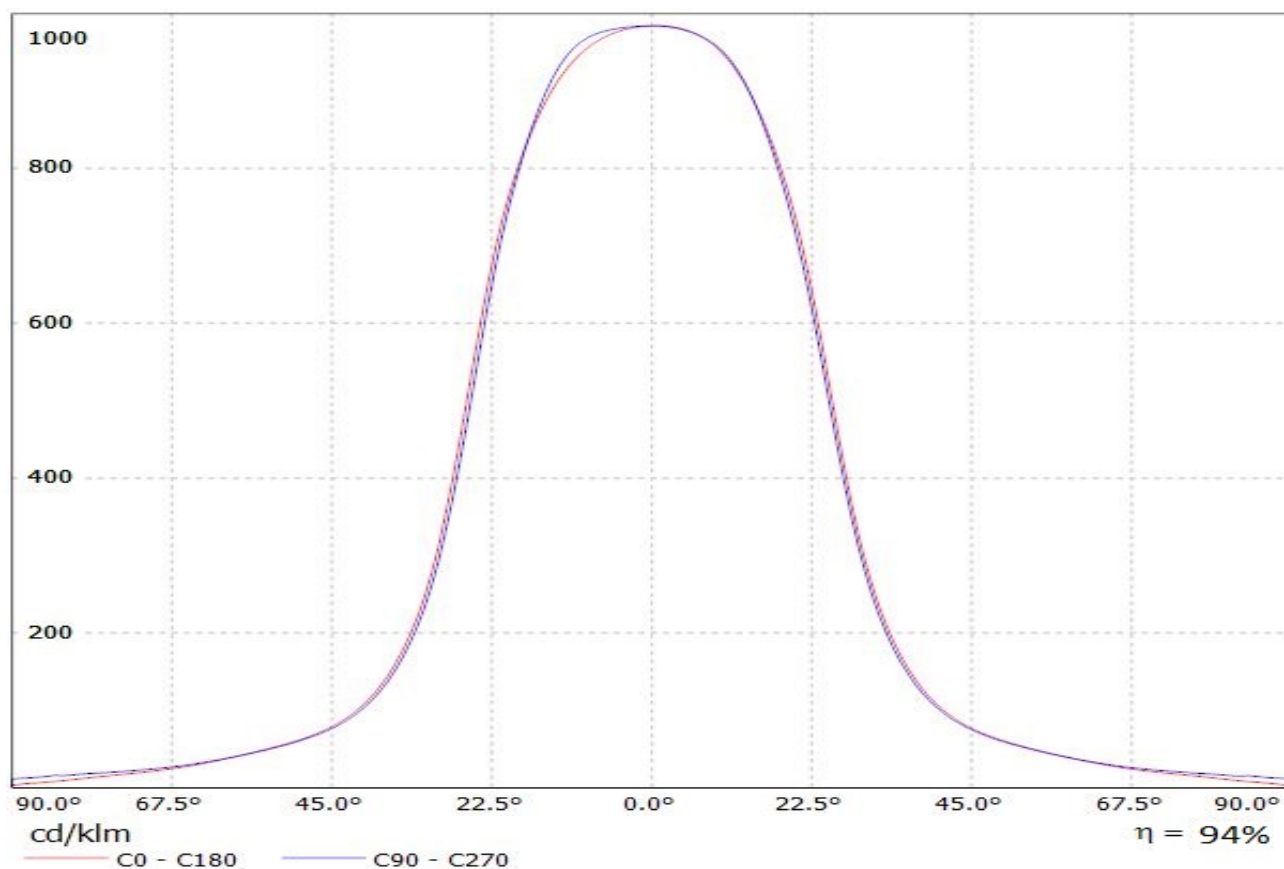

Luminaire: LEDiL Oy C12361_HB-2X2-W_(Tridonic_Module_RLE_G1)
Lamps: 1 x Tridonic_Module_RLE_G1_4576.03lm@700mA_P=32.0681W_I=0.700A

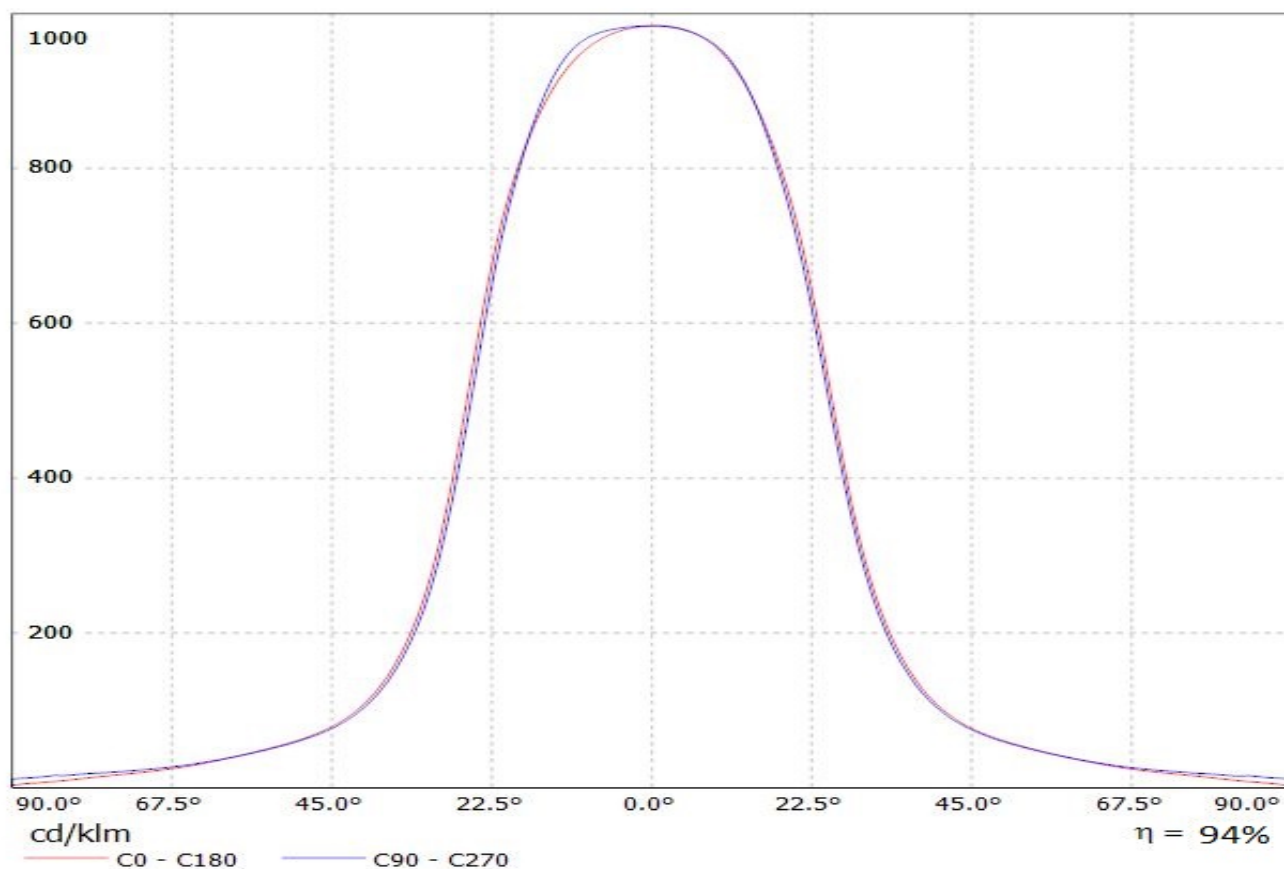

Luminaire: LEDiL Oy C12361_HB-2X2-W_(Tridonic_Module_RLE_G1)
Lamps: 1 x Tridonic_Module_RLE_G1_2288lm@700mA_P=16W_I=0.700A

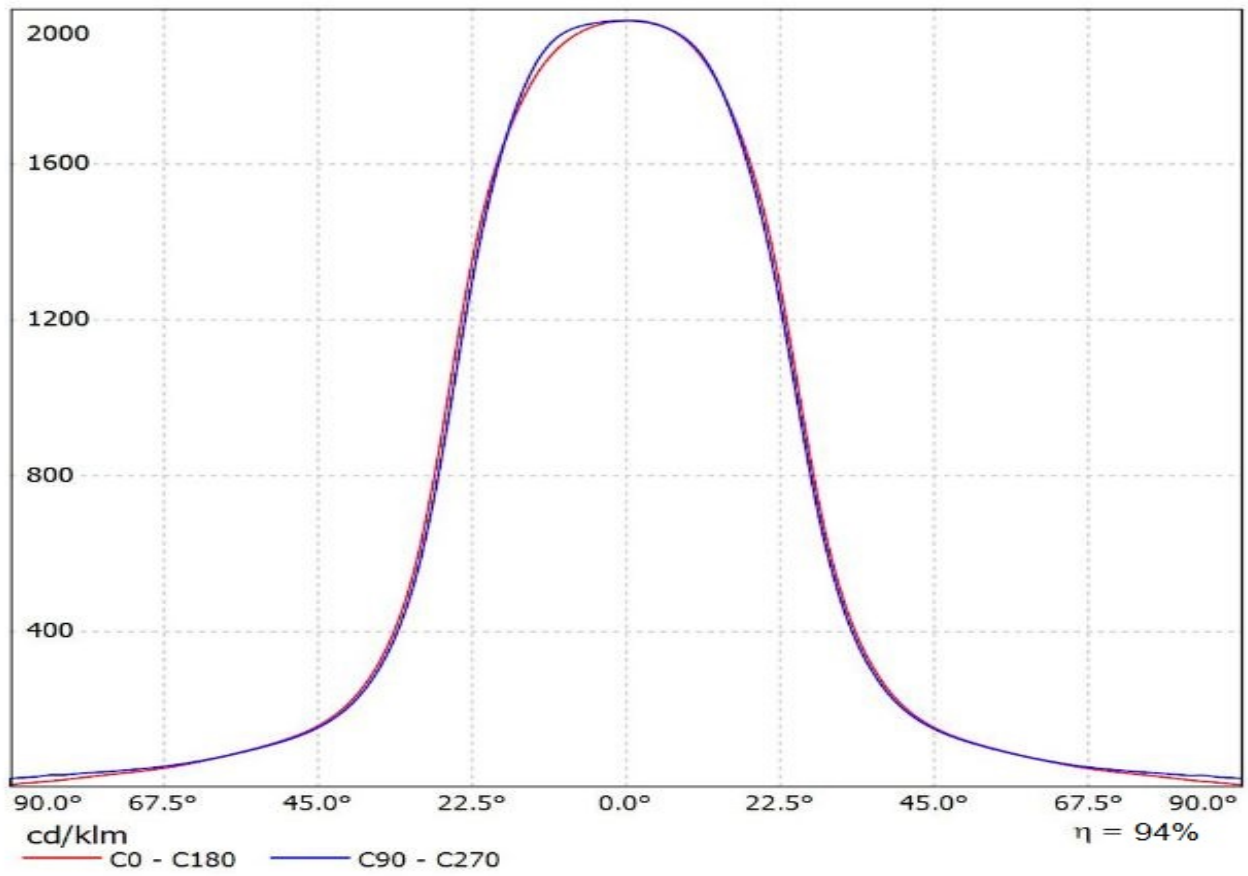

Luminaire: LEDiL Oy C12361_HB-2X2-W_(Tridonic_Module_RLE_G1)
Lamps: 1 x Tridonic_Module_RLE_G1_2288lm@700mA_P=16W_I=0.700A

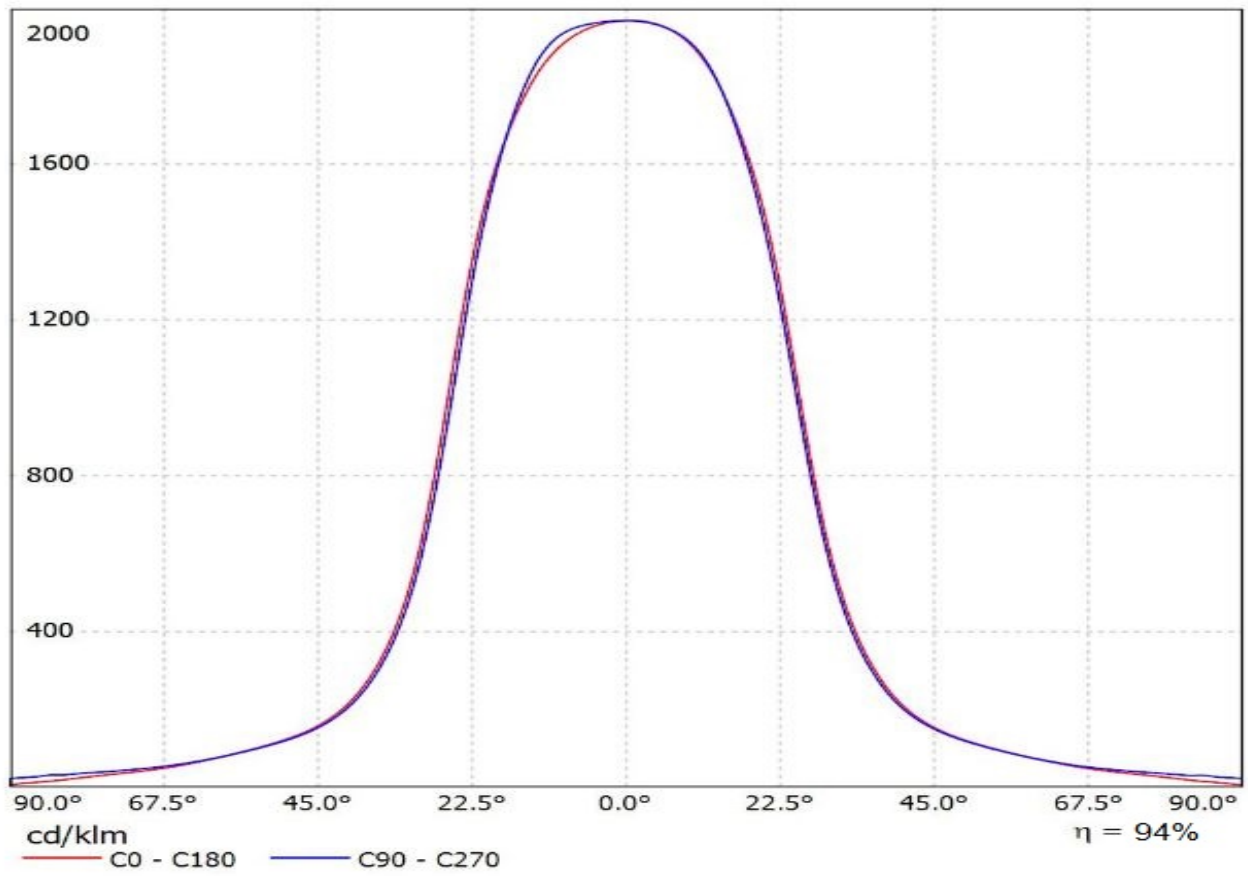

Luminaire: LEDiL Oy C12361_HB-2X2-W_(Bridgelux_5050_Gen2)

Lamps: 1 x Bridgelux_5050_Gen2_2x2_(BXEP-57C-435-09B)_1447.45lm@250mA_CCT=5700K_P=8.29761W_I=0.25A

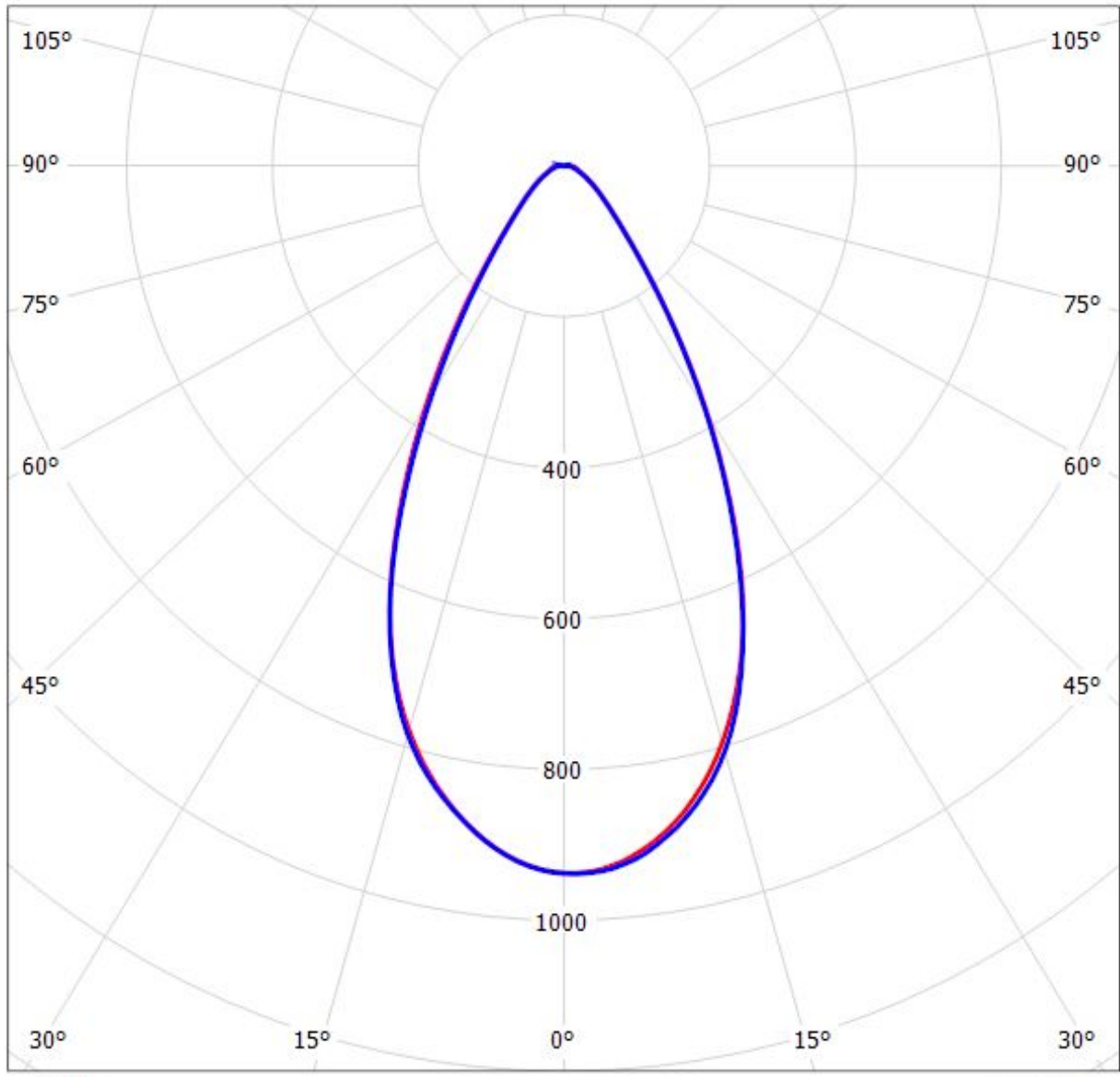

cd/klm

— C0 - C180 — C90 - C270

$\eta = 95\%$

Luminaire: LEDIL OY C12361_HB-2X2 (XM-L) Efficiency=89%

Lamps: 1 x Cree XM-L (395lm @ 250mA)

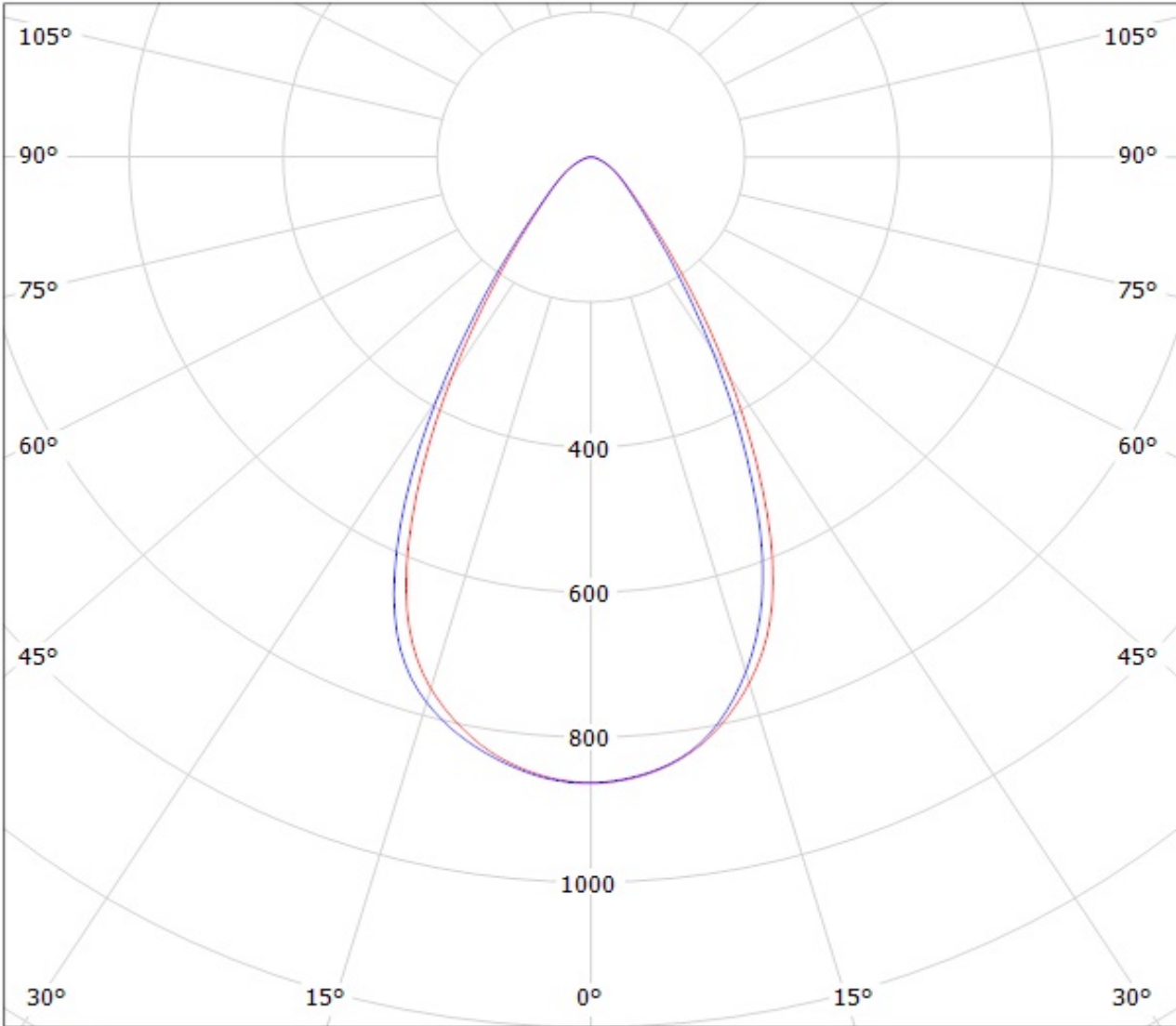

cd/klm

— C0 - C180

— C90 - C270

Luminaire: LEDIL OY C12361_HB-2X2 (XP-G) Efficiency=88%

Lamps: 1 x Cree XP-G (257lm @ 250mA)

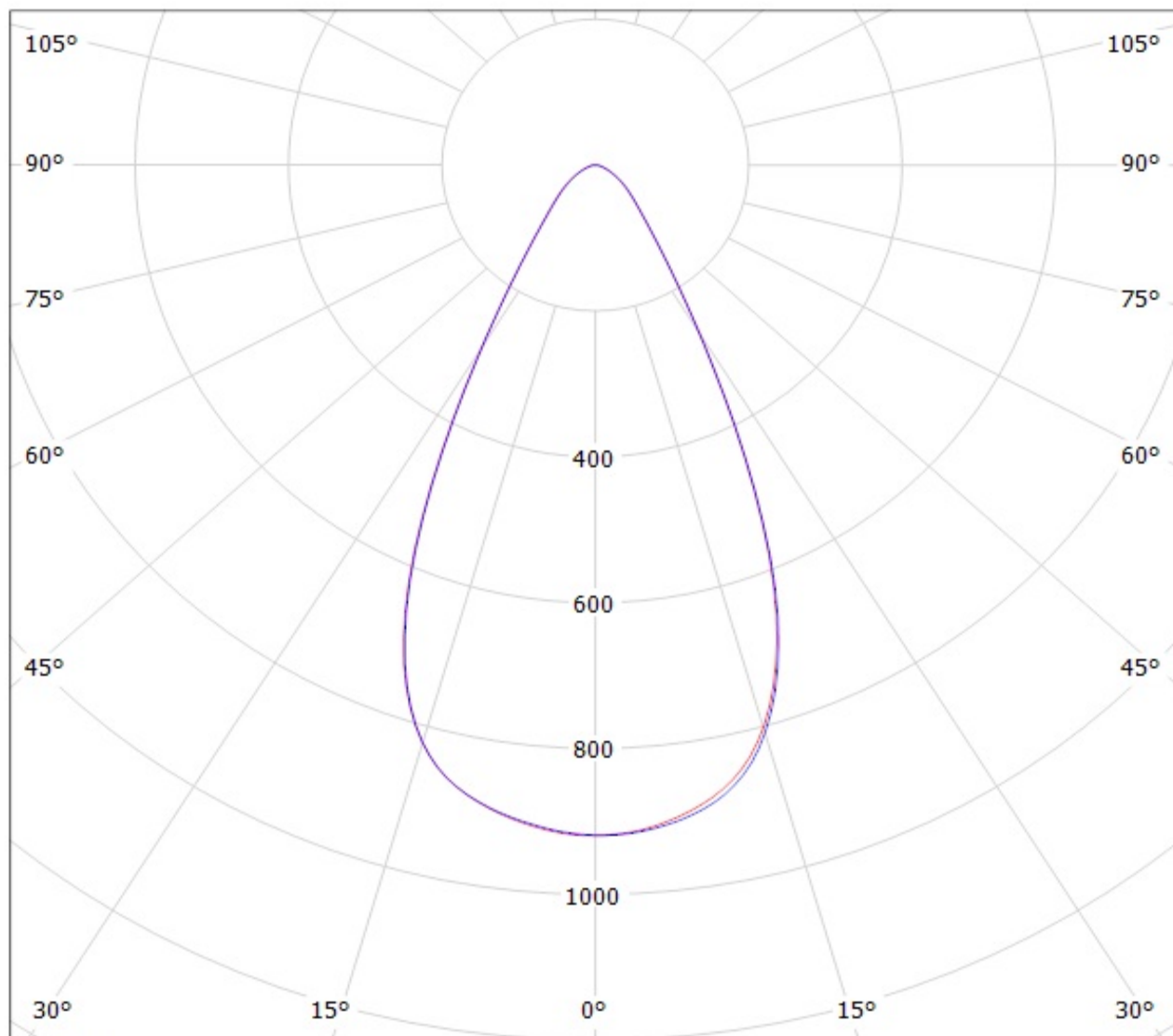

cd/klm

— C0 - C180

— C90 - C270

Luminaire: LEDIL OY C12361_HB-2X2 (XT-E AWT) Efficiency=89%
Lamps: 1 x Cree XT-E AWT (390lm@250mA)

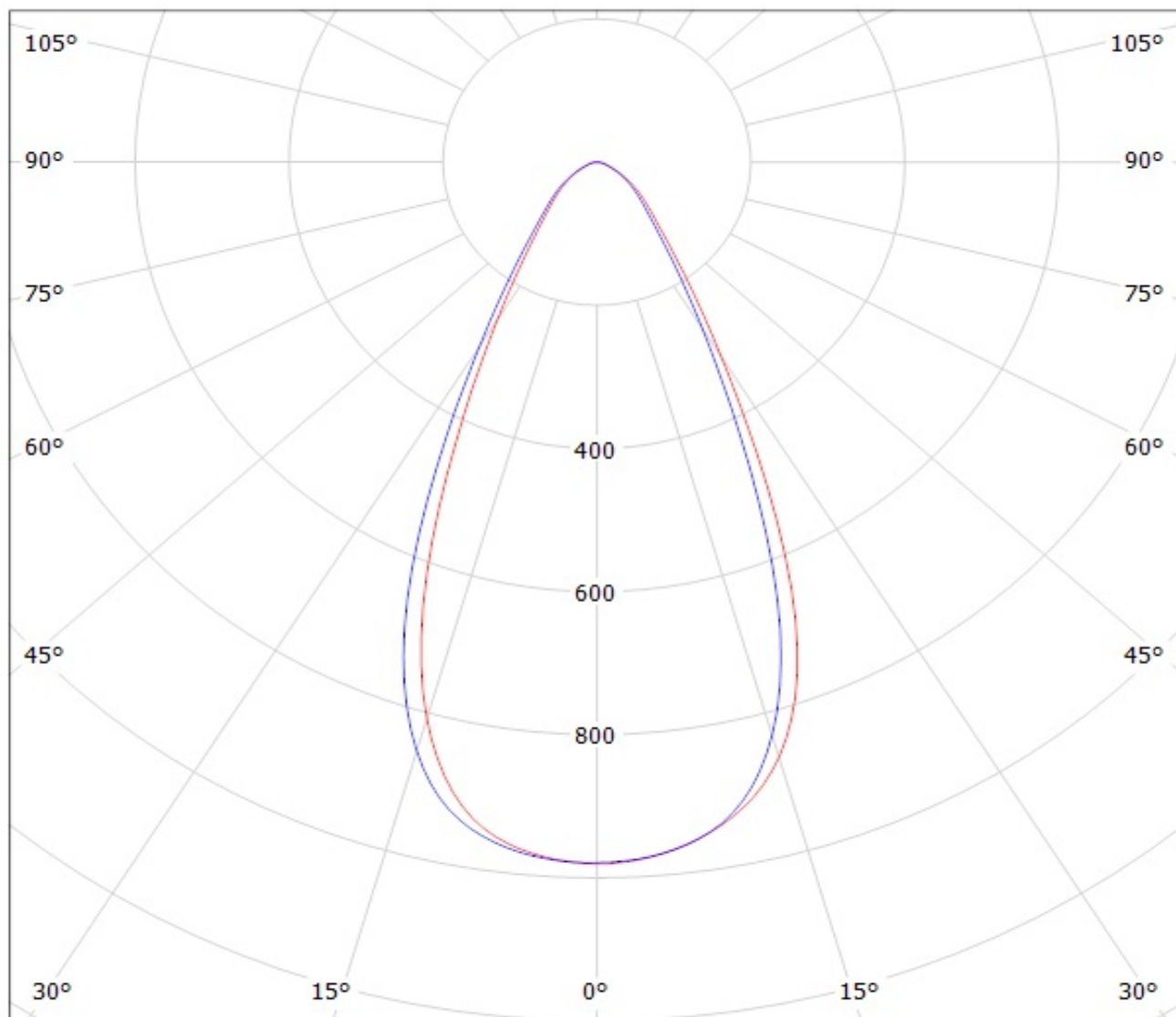

cd/klm

— C0 - C180

— C90 - C270

Luminaire: LEDIL OY C12361_HB-2X2 (XB-D) Efficiency=86%
Lamps: 1 x Cree XB-DE (371lm @ 250mA)

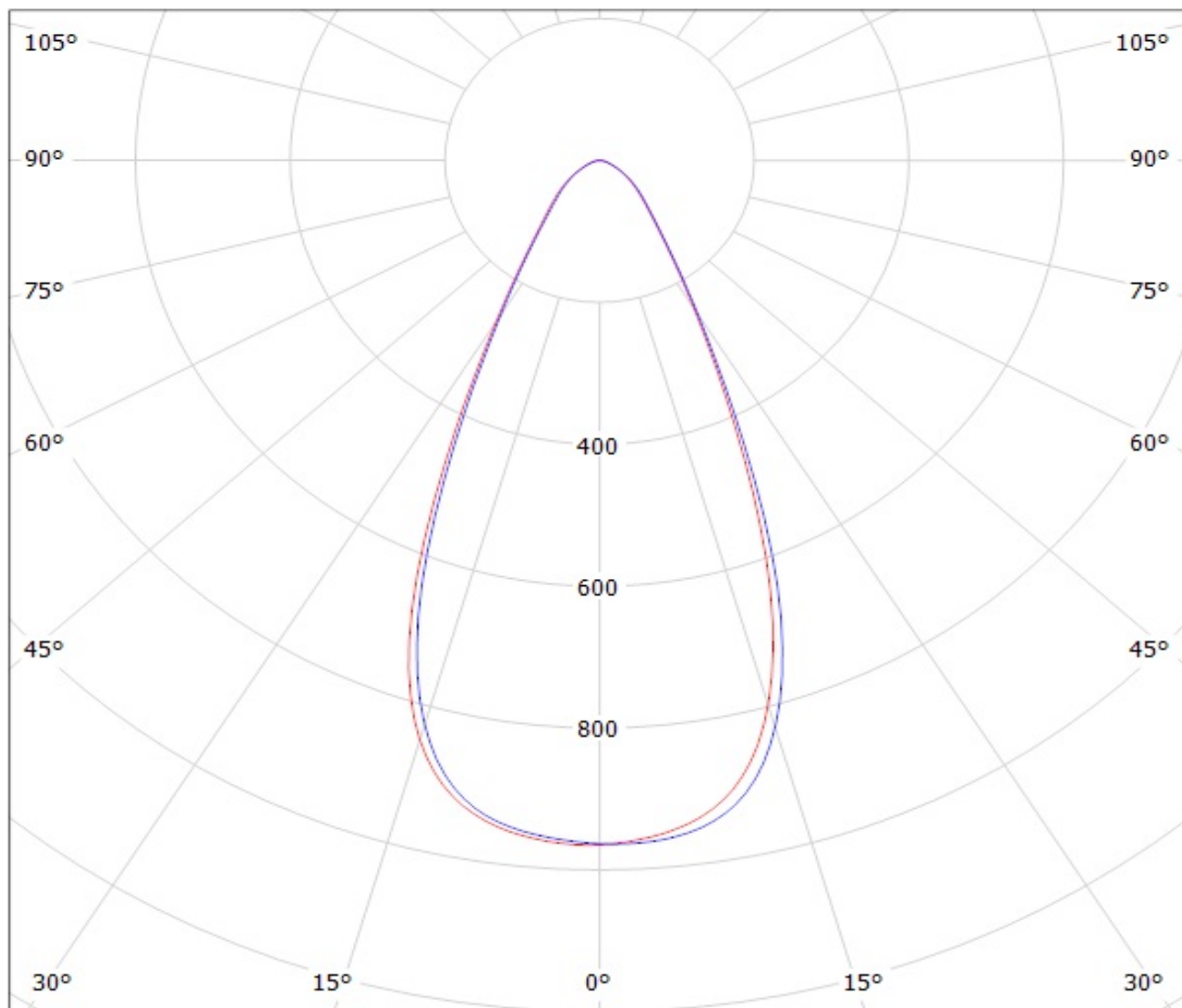

cd/klm

— C0 - C180

— C90 - C270

Luminaire: Ledil Oy C12361_HB-2X2-W_(XM-L2) Efficiency=87%
Lamps: 1 x Cree XM-L2 (CXMLBWT-0-7B4-T30-0L-001) 360lm @ 250mA CCT=3220K P=2.8W I=250mA

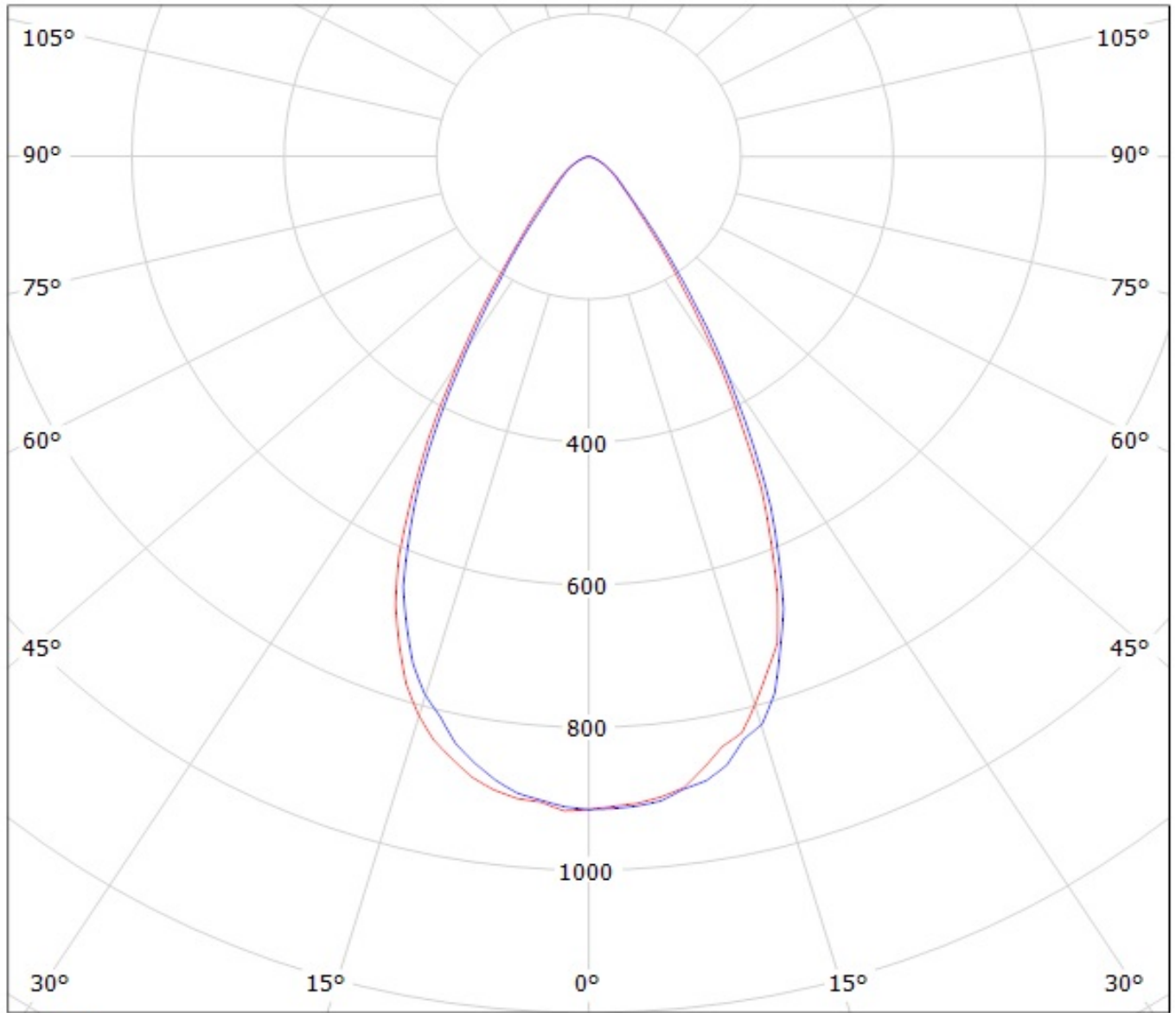

cd/klm

— C0 - C180

— C90 - C270

Luminaire: LEDiL Oy C12361_HB-2X2-W_(XP-L) Eff.87.0%

Lamps: 1 x CREE_XP-L_2x2_(XPLAWT-0-1B0-V40-00-0001)_504.373lm@250mA_CCT=7600K_P=2.79963W_I=249.9mA

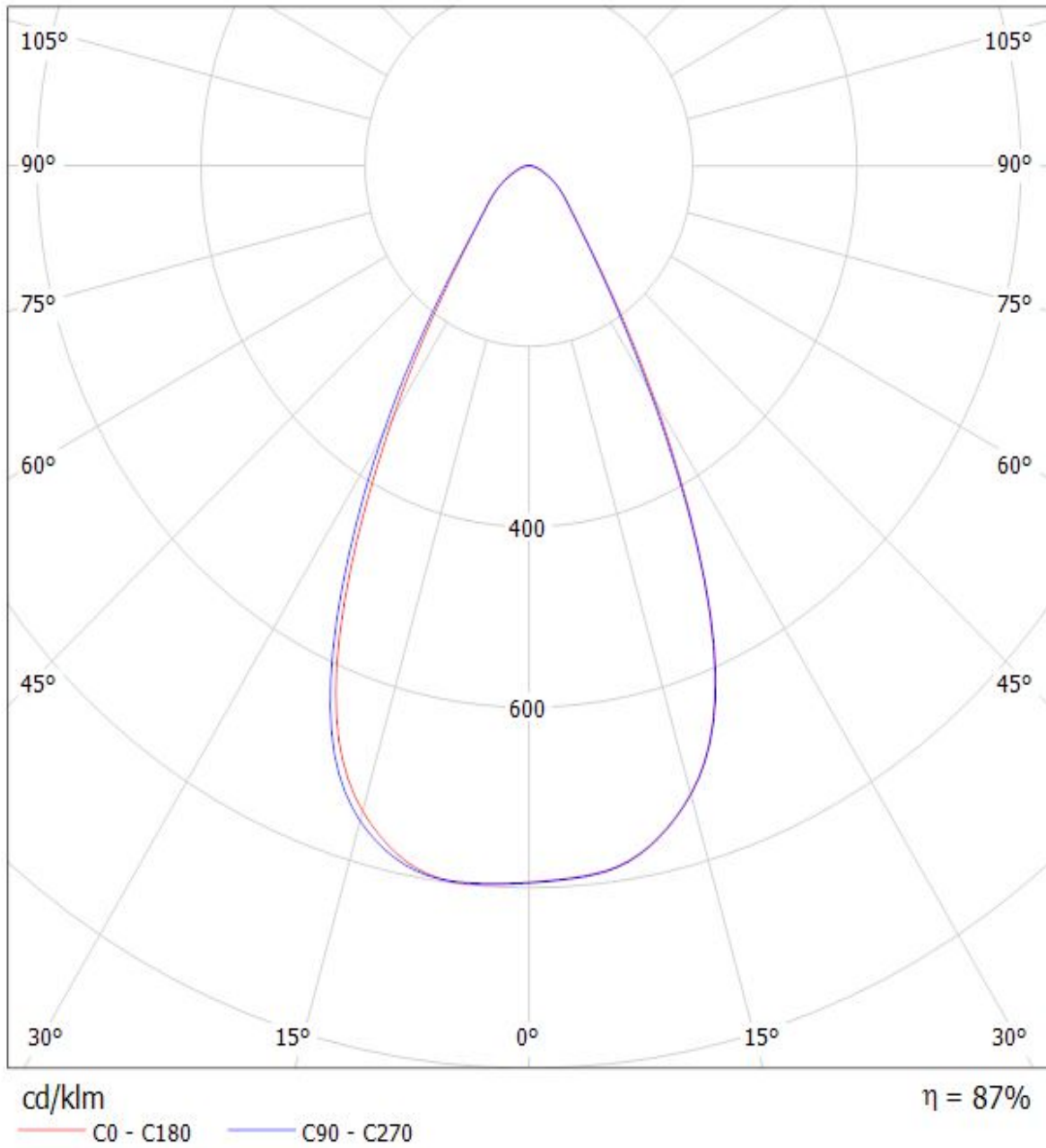

Luminaire: Ledil Oy C12361_HB-2X2-W_(XP-G3)_SIMULATED
Lamps: 1 x Cree XP-G3

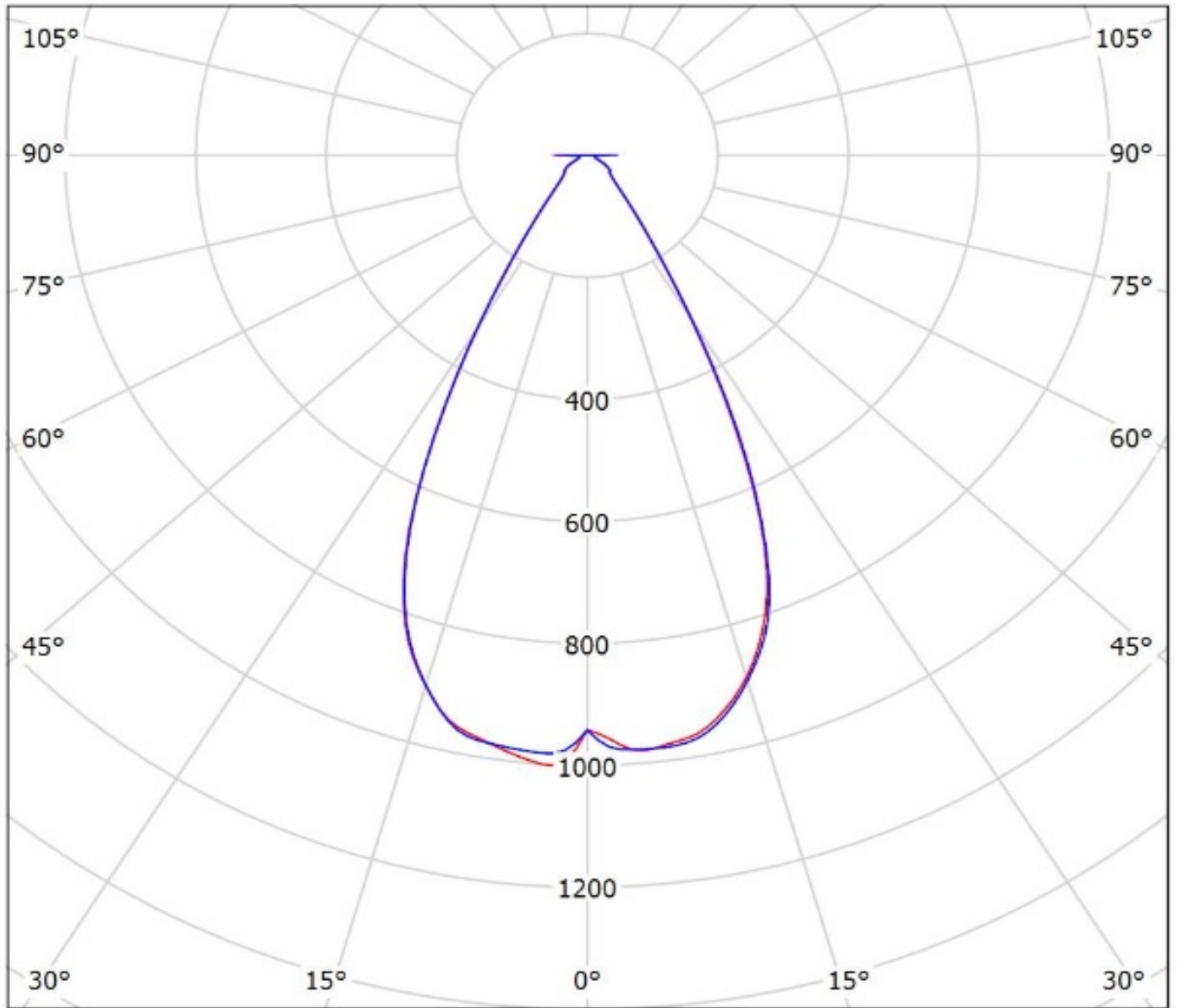

cd/klm

— C0 - C180 — C90 - C270

$\eta = 95\%$

Luminaire: Ledil C12361_HB-2X2-W_(XP-L2)

Lamps: 1 x Cree_XP-L2_2x2_(XPLBWT-00-0000-000BV50E3)550.93lm@250mA_P=2.7815W_I=0.25A

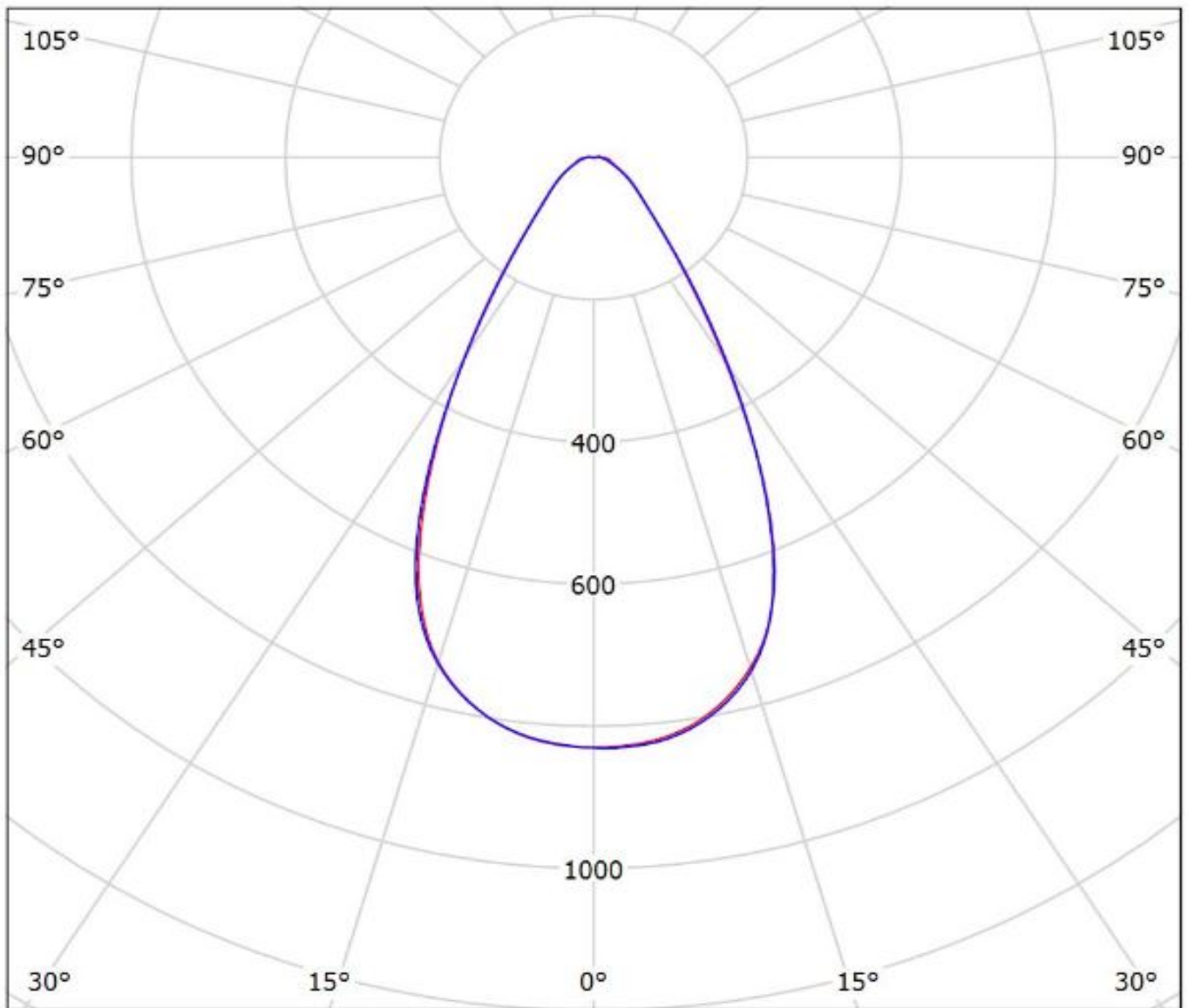

cd/klm

— C0 - C180

— C90 - C270

$\eta = 92\%$

Luminaire: Ledil Oy C12361_HB-2X2-W_(3535_Ceramic_gen2) Efficiency=86%
Lamps: 1 x LG 3535 Ceramic gen2 (PKG5700K) 461lm @ 250mA CCT=6600K P=2.9W I=250mA

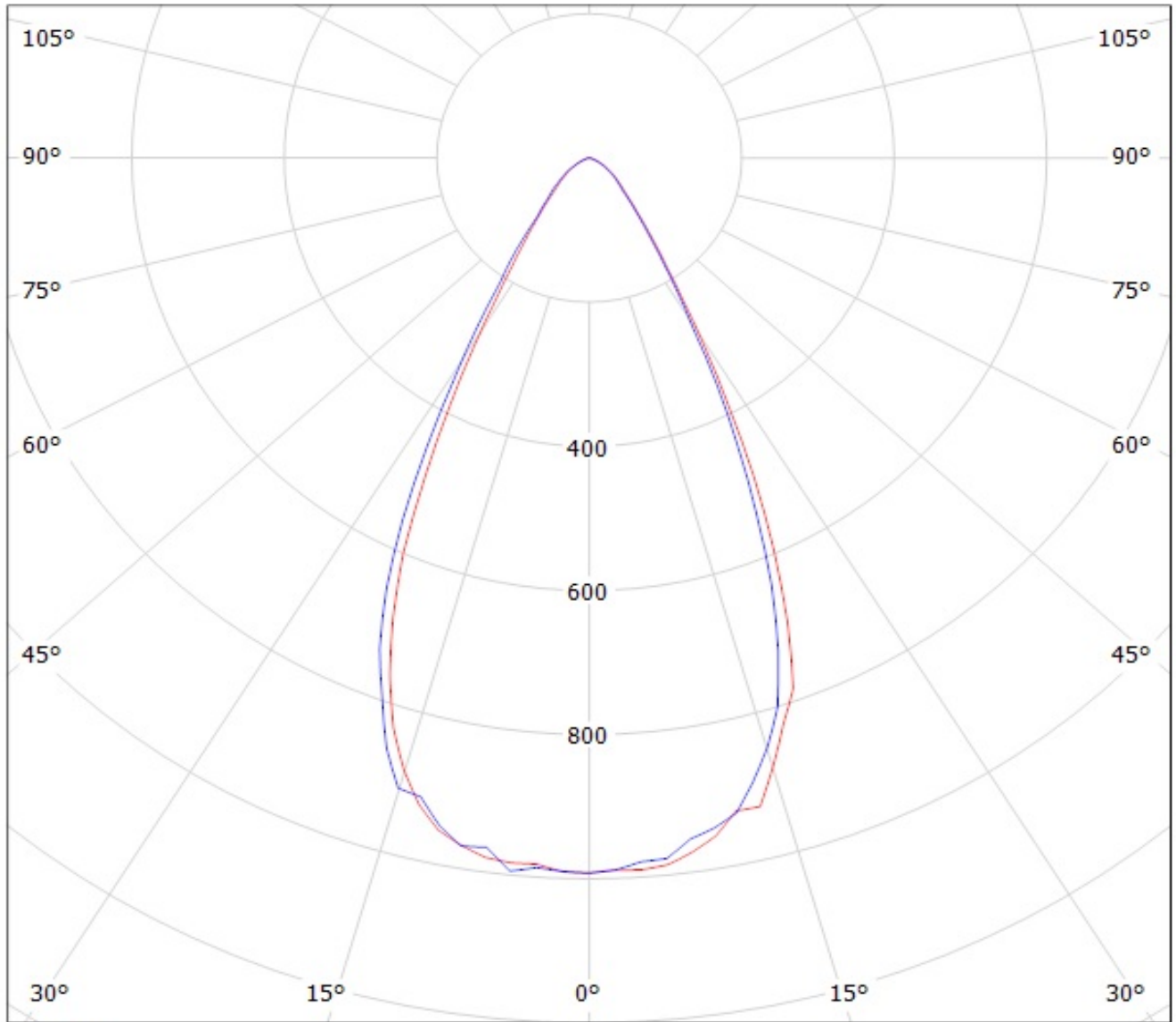

cd/klm
— C0 - C180 — C90 - C270

Luminaire: LEDIL OY C12361_HB-2X2 (RE-ES) Efficiency=87%
Lamps: 1 x Luxeon Rebel-ES (339lm @ 250mA)

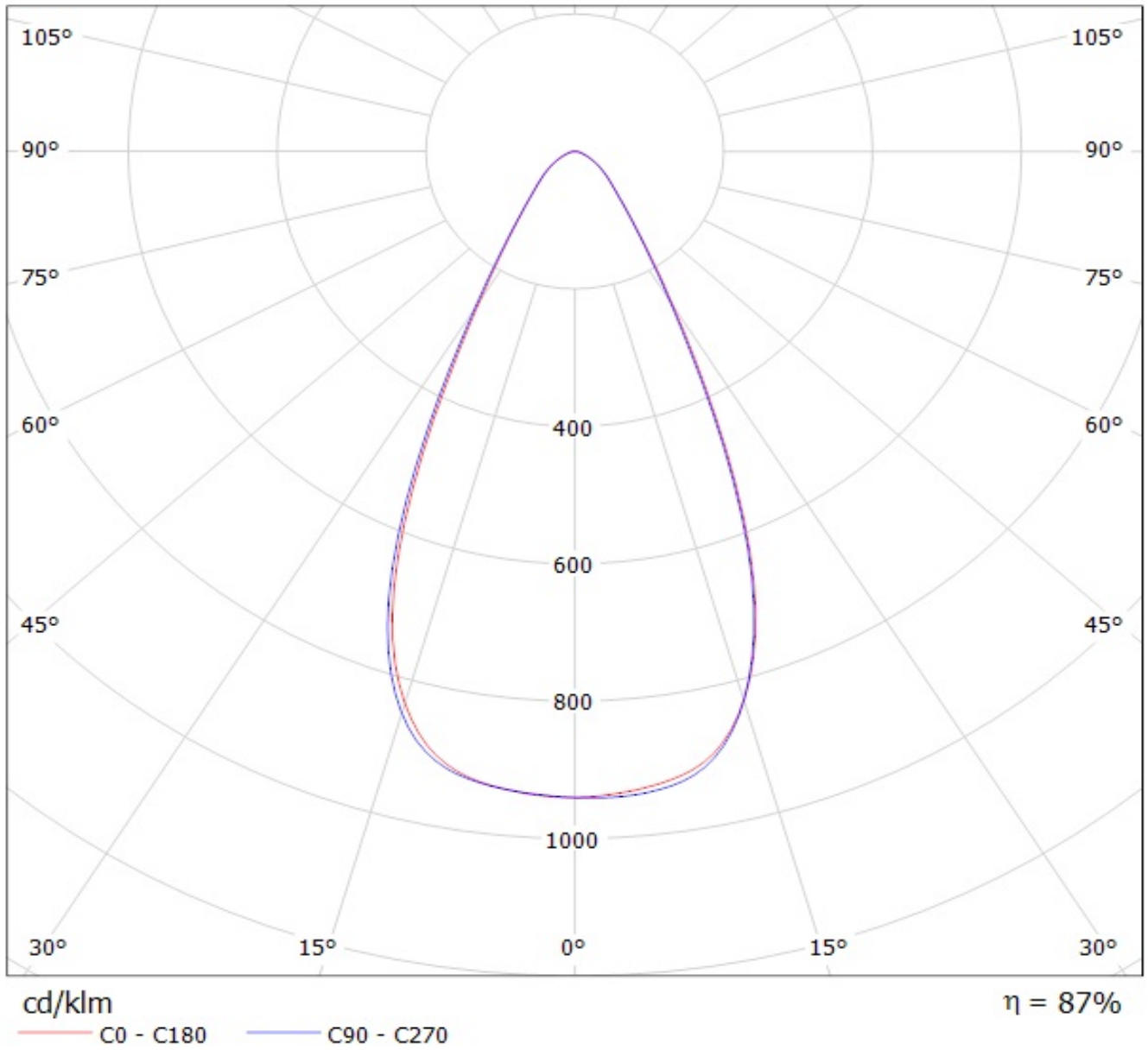

Luminaire: LEDiL Oy C12361_HB-2X2-W_(LUXEON_T)_1 Eff.87.0%
Lamps: 1 x LUXEON_T 2x2 (294lm@250mA)

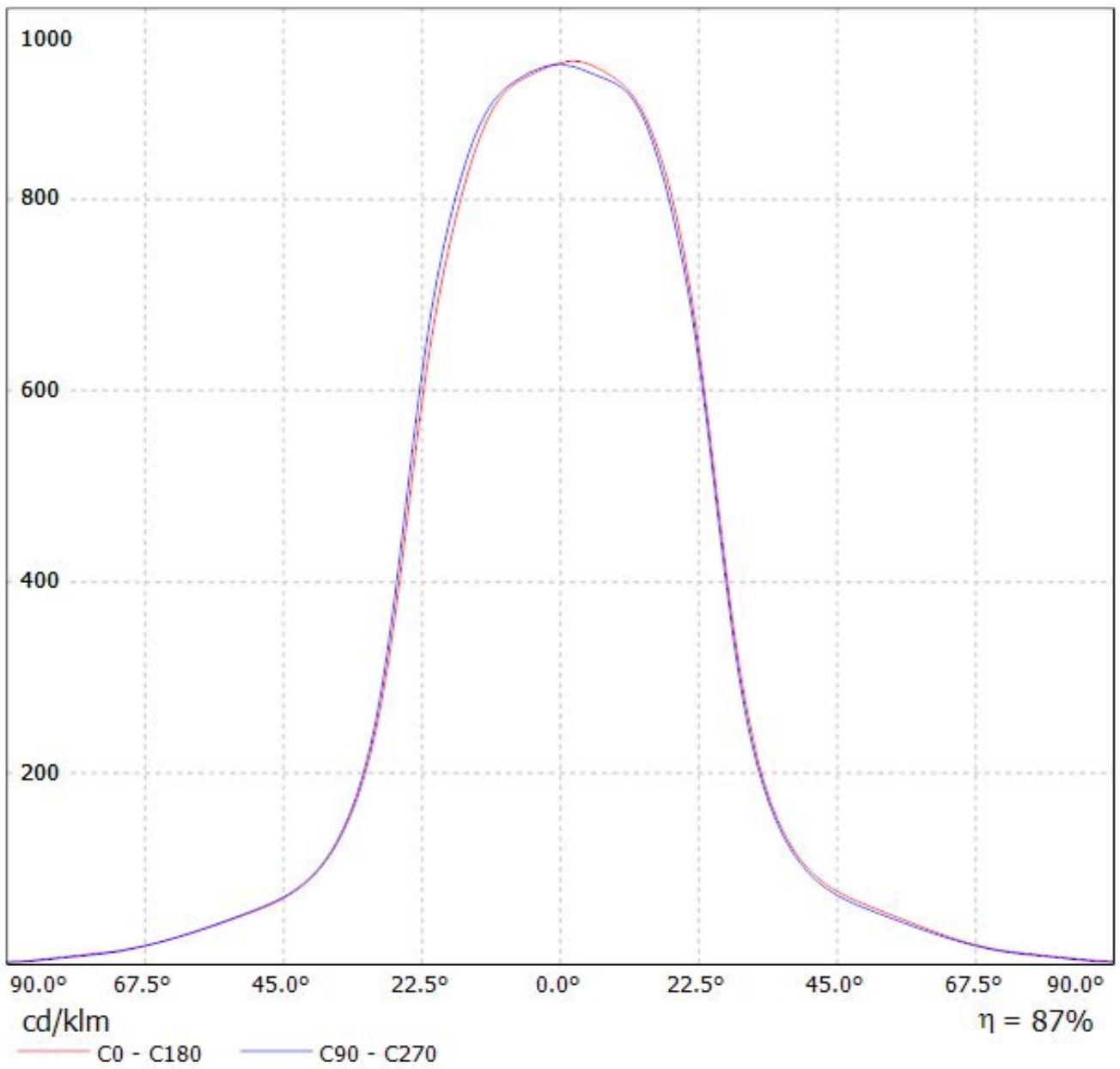

Luminaire: Ledil Oy C12361_HB-2X2-W_(Luxeon_Z_ES) Efficiency=87%

Lamps: 1 x Luxeon Z ES 2x2 (LXZ2-3090) 209lm @ 250mA CCT=3000K P=2.8W I=250mA

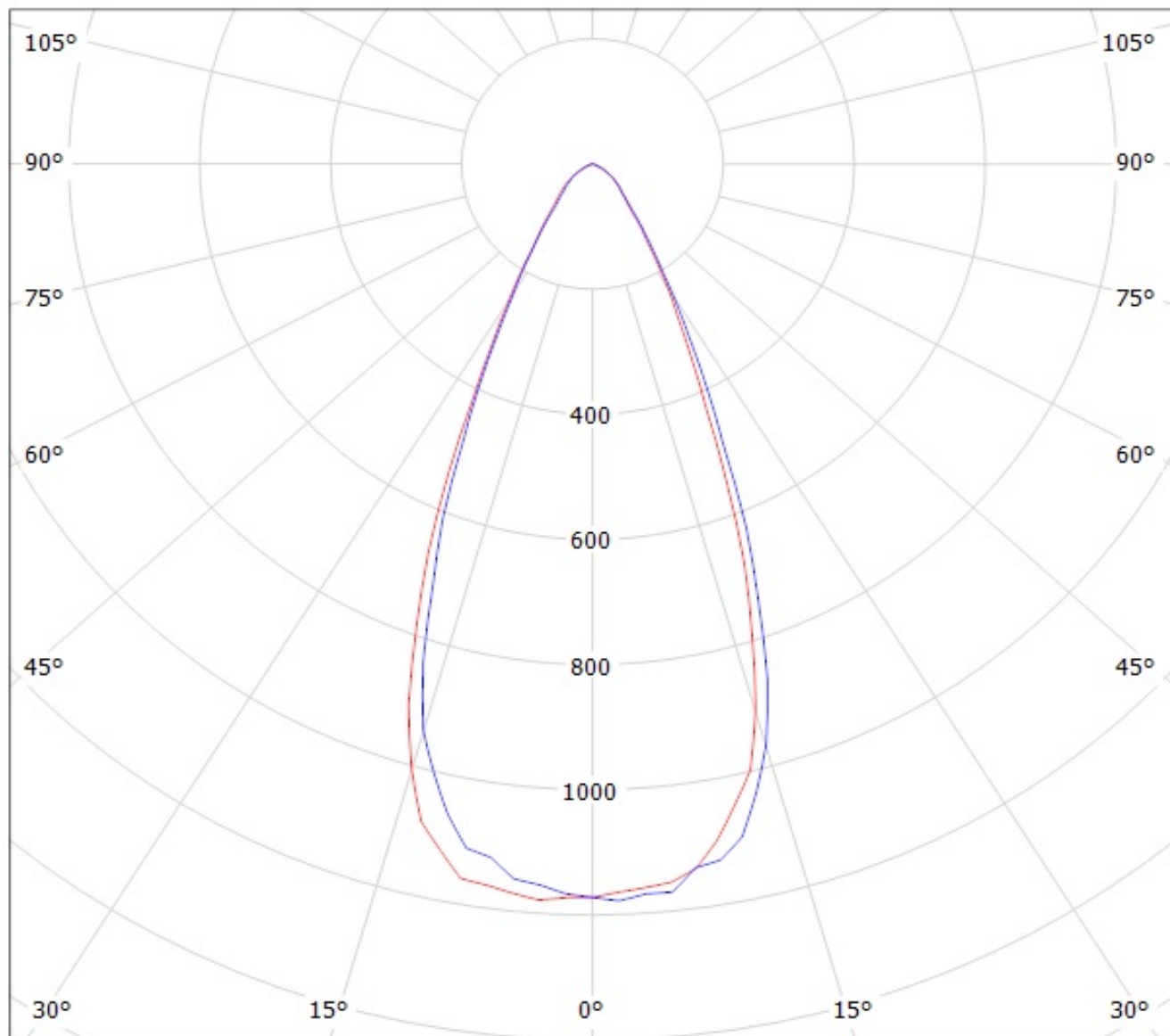

cd/klm

— C0 - C180

— C90 - C270

Luminaire: LEDiL Oy C12361_HB-2X2-W_(LUXEON_Q) Eff.86.3%

Lamps: 1 x LUXEON_Q_2x2_(LHQ-3080)_298.363lm@250mA_P=2.87385W_I=249.9mA

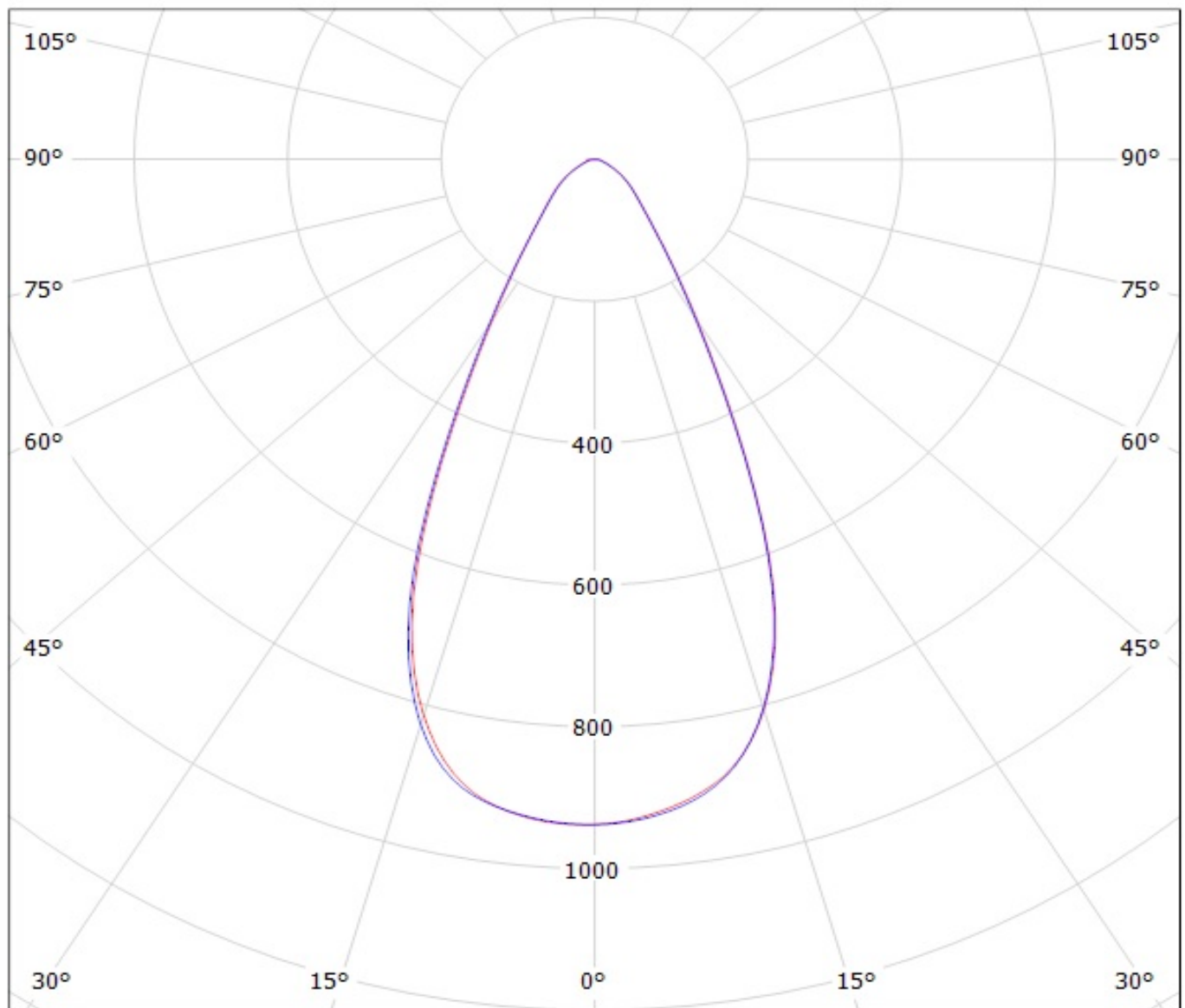

cd/klm

— C0 - C180

— C90 - C270

Luminaire: Ledil C12361_HB-2X2-W_(Luxeon_MZ)

Lamps: 1 x Philips_Lumileds_Luxeon_MZ_(LMZ7-QW57)_(2x2)_427.268lm@250mA_P=2.734W_I=0.2500A

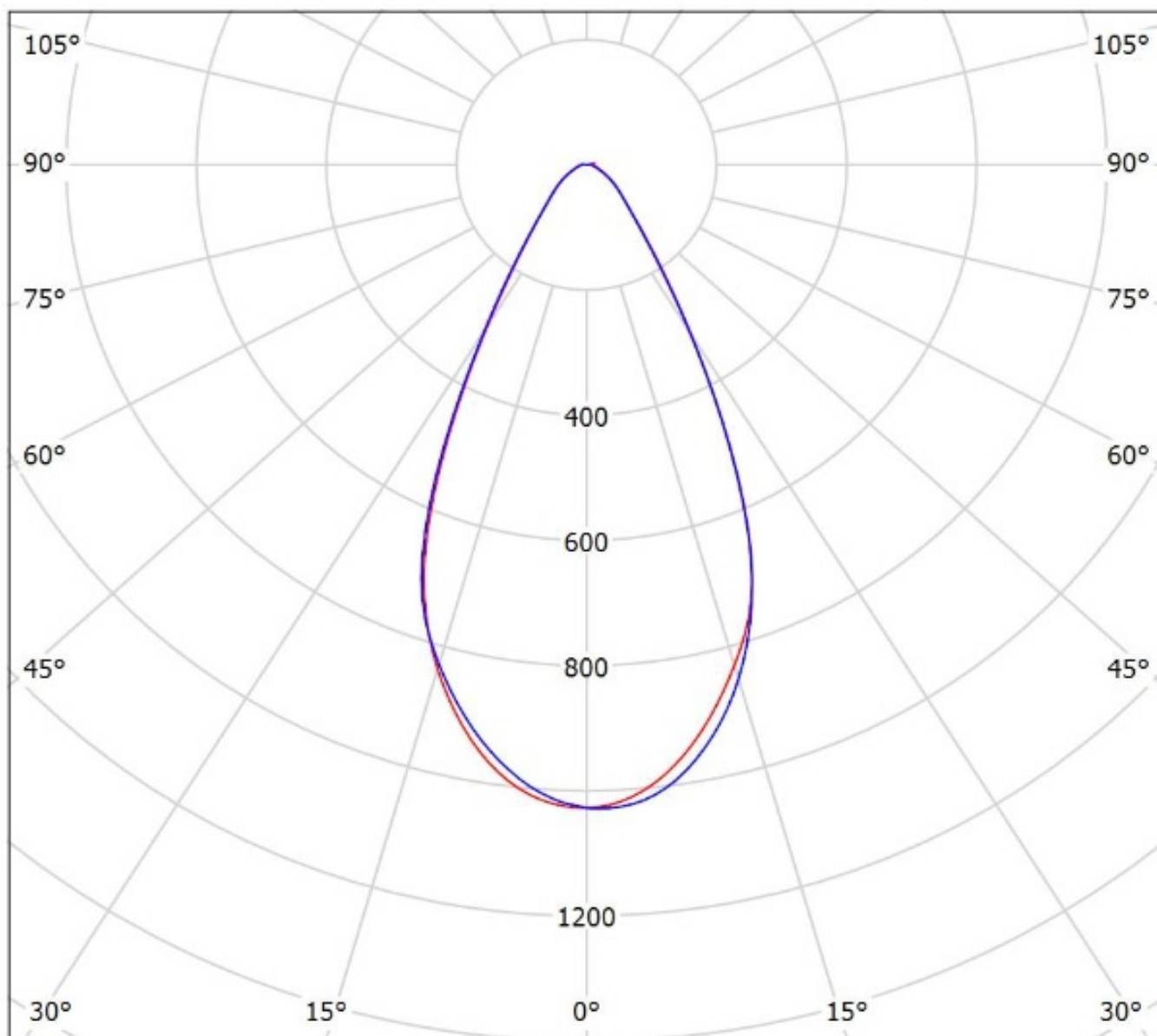

cd/klm

— C0 - C180 — C90 - C270

$\eta = 92\%$

Luminaire: LEDiL Oy C12361_HB-2X2-W_(Luxeon_TX) Eff.87.5%
Lamps: 1 x Luxeon_TX_2x2_320.412lm@250mA_P=2.79013W_I=249.9mA

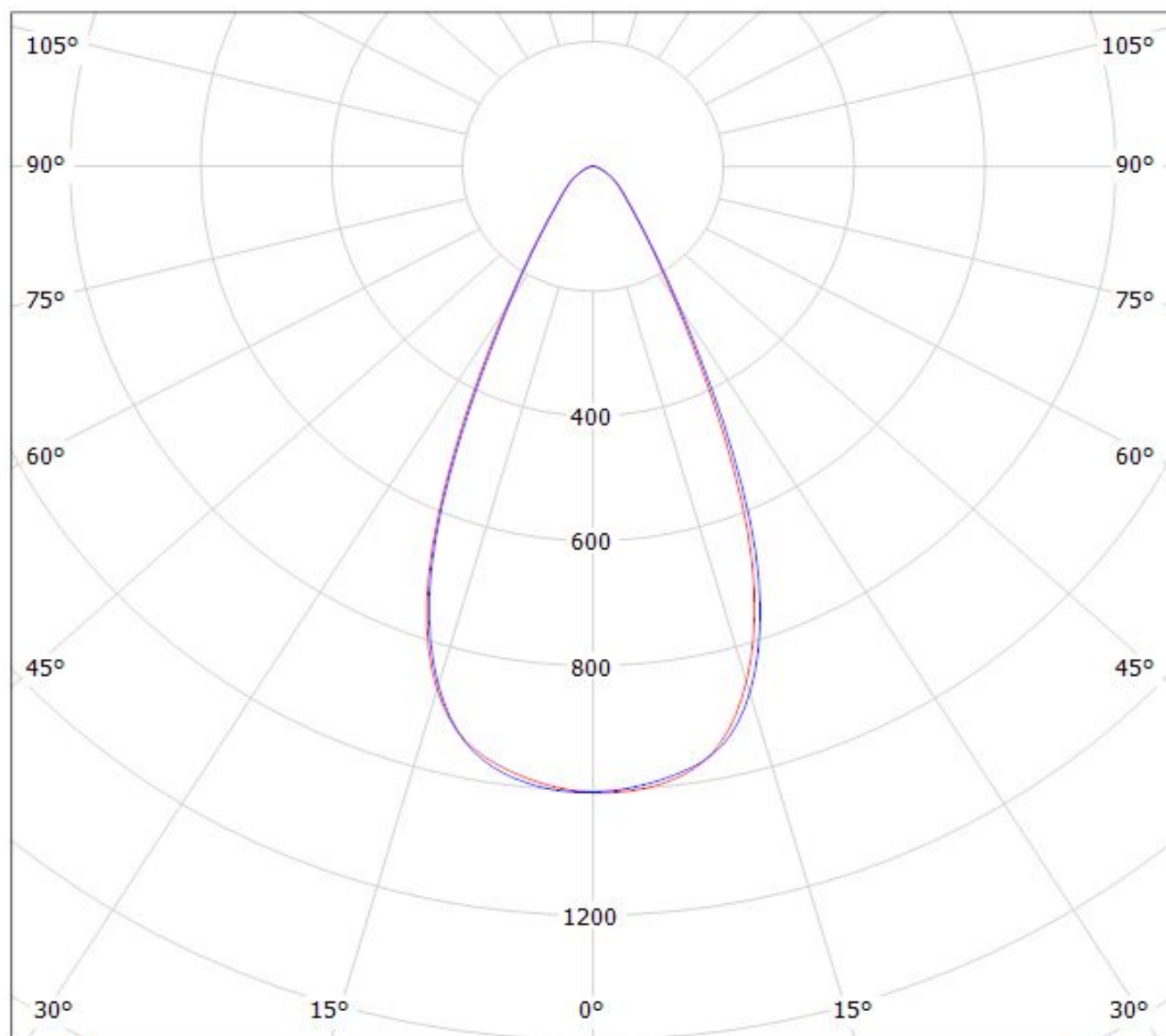

cd/klm

— C0 - C180 — C90 - C270

$\eta = 88\%$

Luminaire: LEDiL Oy C12361_HB-2X2-W_(Luxeon_5050)

Lamps: 1 x Luxeon_5050_2x2_1270.76lm@80mA_CCT=5700K_P=7.35815W_I=0.080A_70CRI

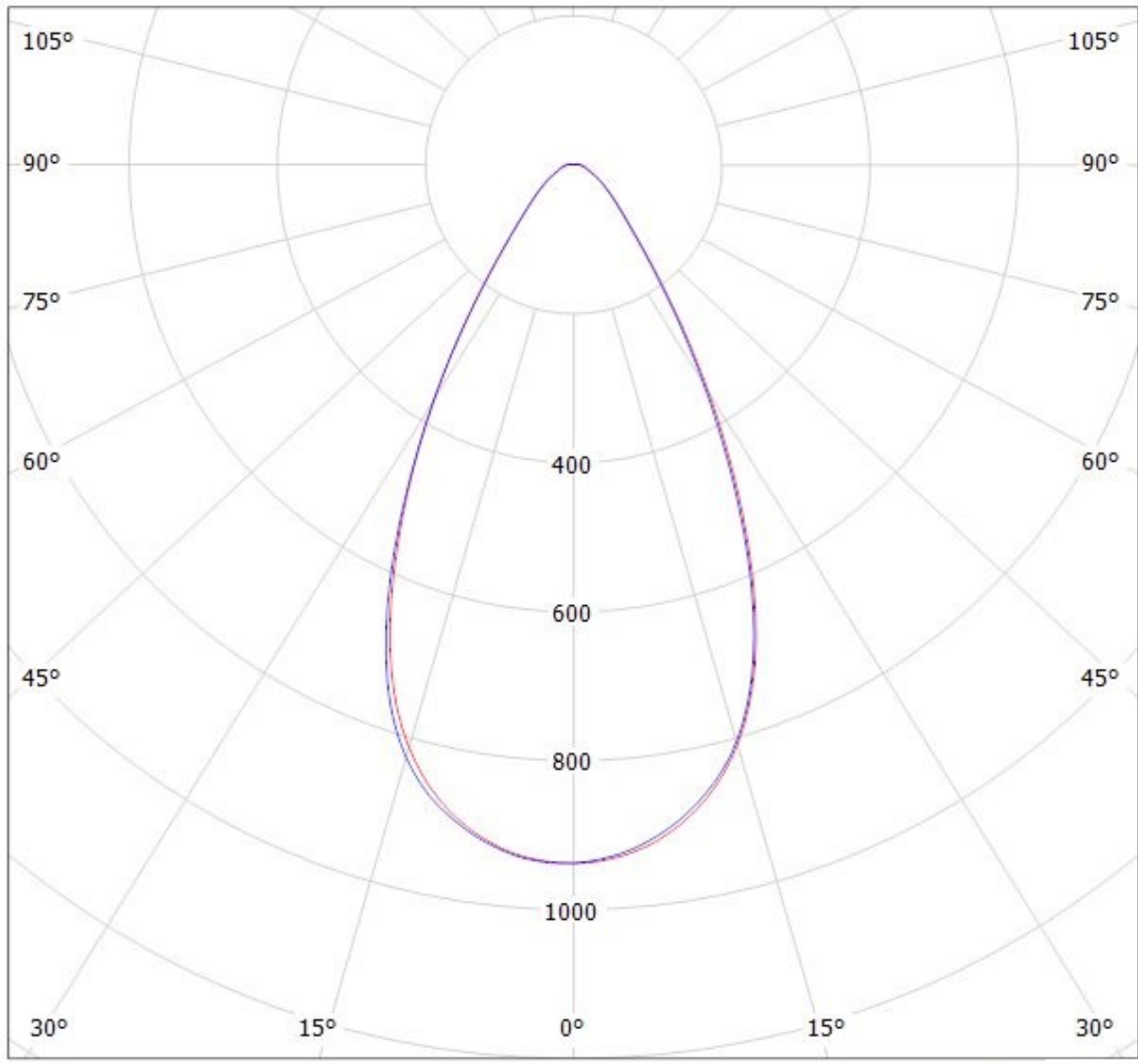

cd/klm

— C0 - C180

— C90 - C270

$\eta = 94\%$

Luminaire: Ledil Oy C12361_HB-2X2-W_(Luxeon_3030_2D)_SIMULATED
Lamps: 1 x Lumileds Luxeon 3030 2D

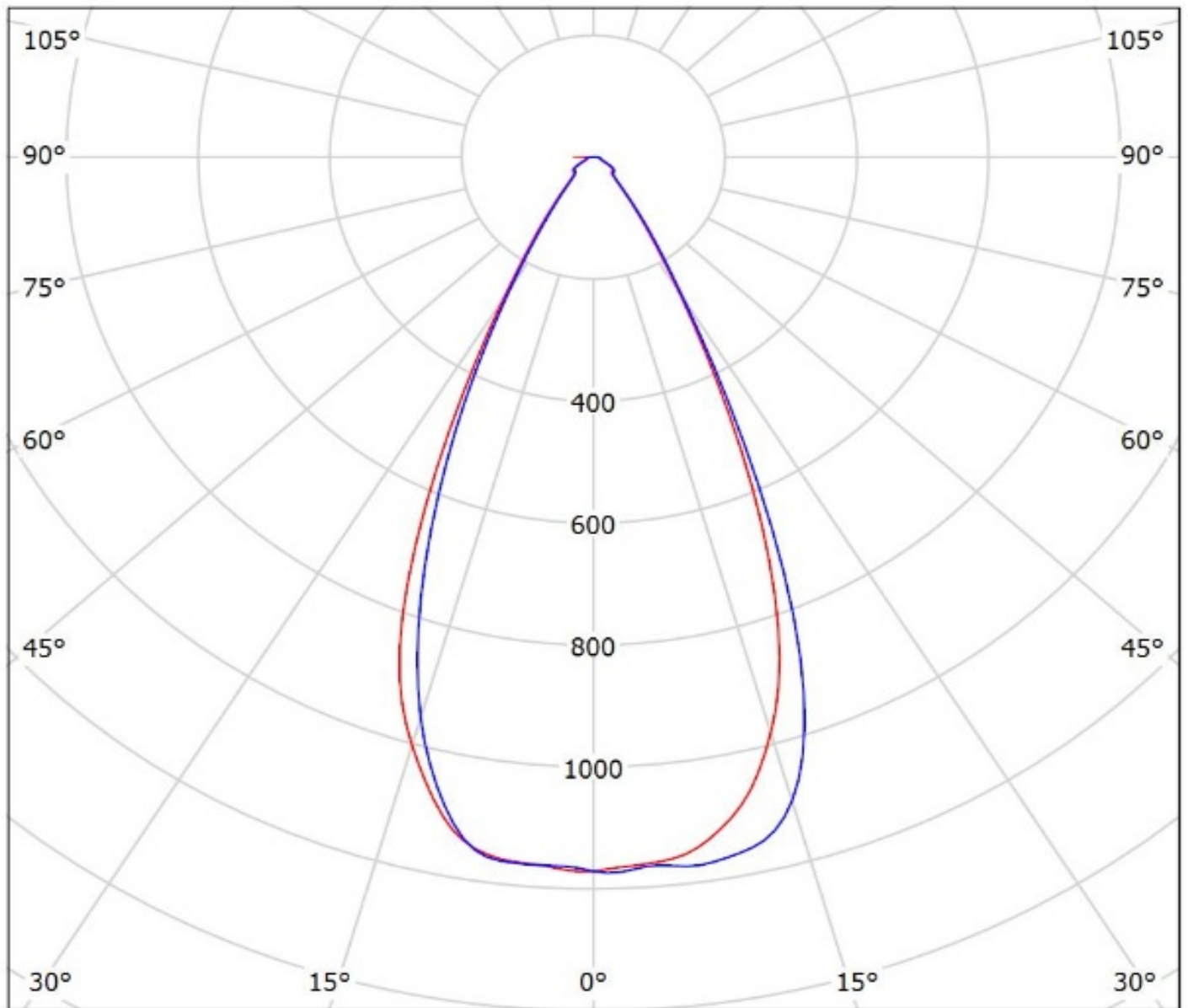

cd/klm

— C0 - C180 — C90 - C270

$\eta = 95\%$

Luminaire: Ledil Oy C12361_HB-2X2-W_(Luxeon_3535L)_SIMULATED

Lamps: 1 x Lumileds Luxeon 3535L

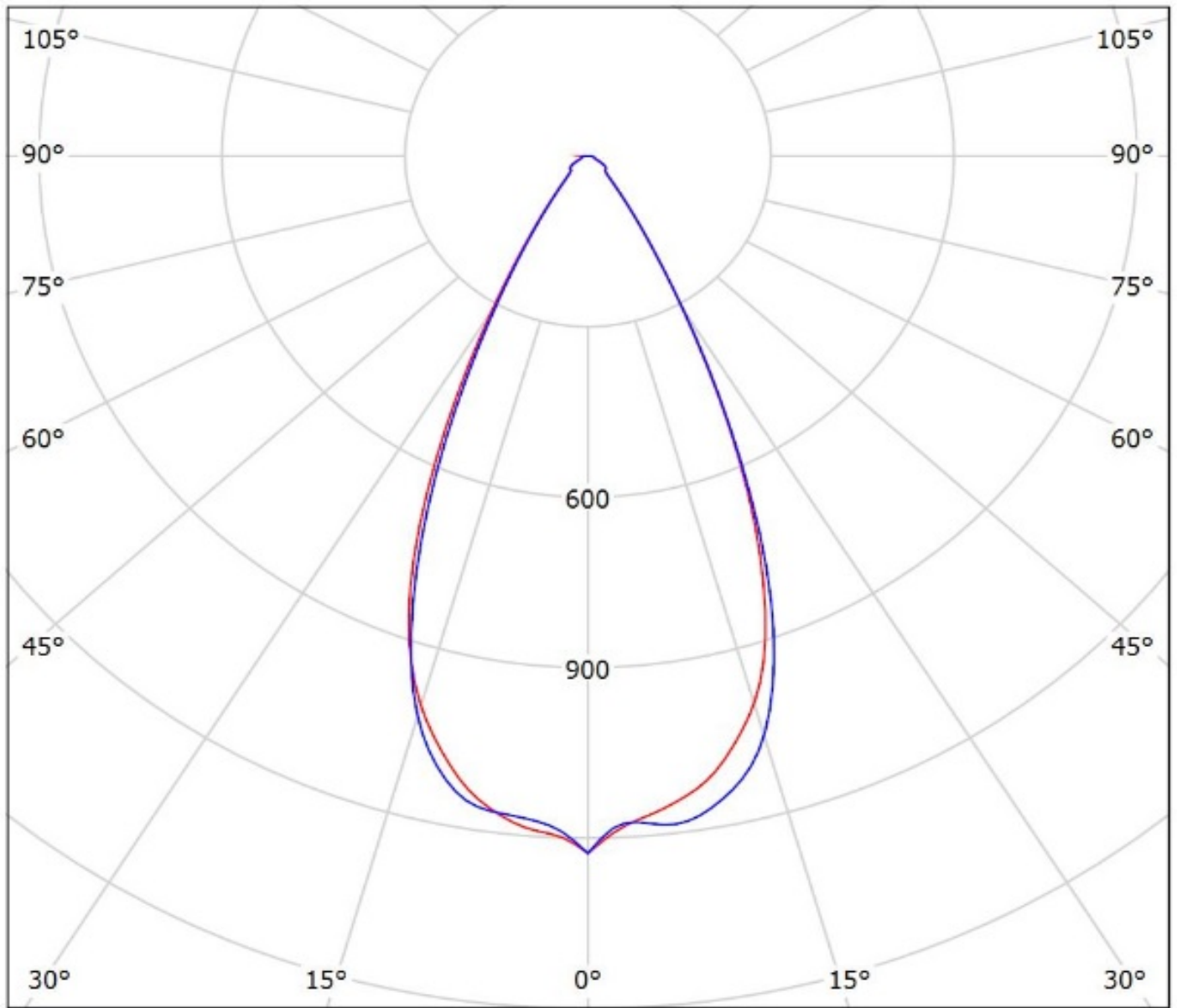

cd/klm

— C0 - C180 — C90 - C270

$\eta = 95\%$

Luminaire: LEDil Oy C12361_HB-2x2-W_(NCSxx19A) Efficiency=85%
Lamps: 1 x Nichia NCSL119AT-H1) 229lm @ 250mA CCT=2800K P=3.1W I=250mA

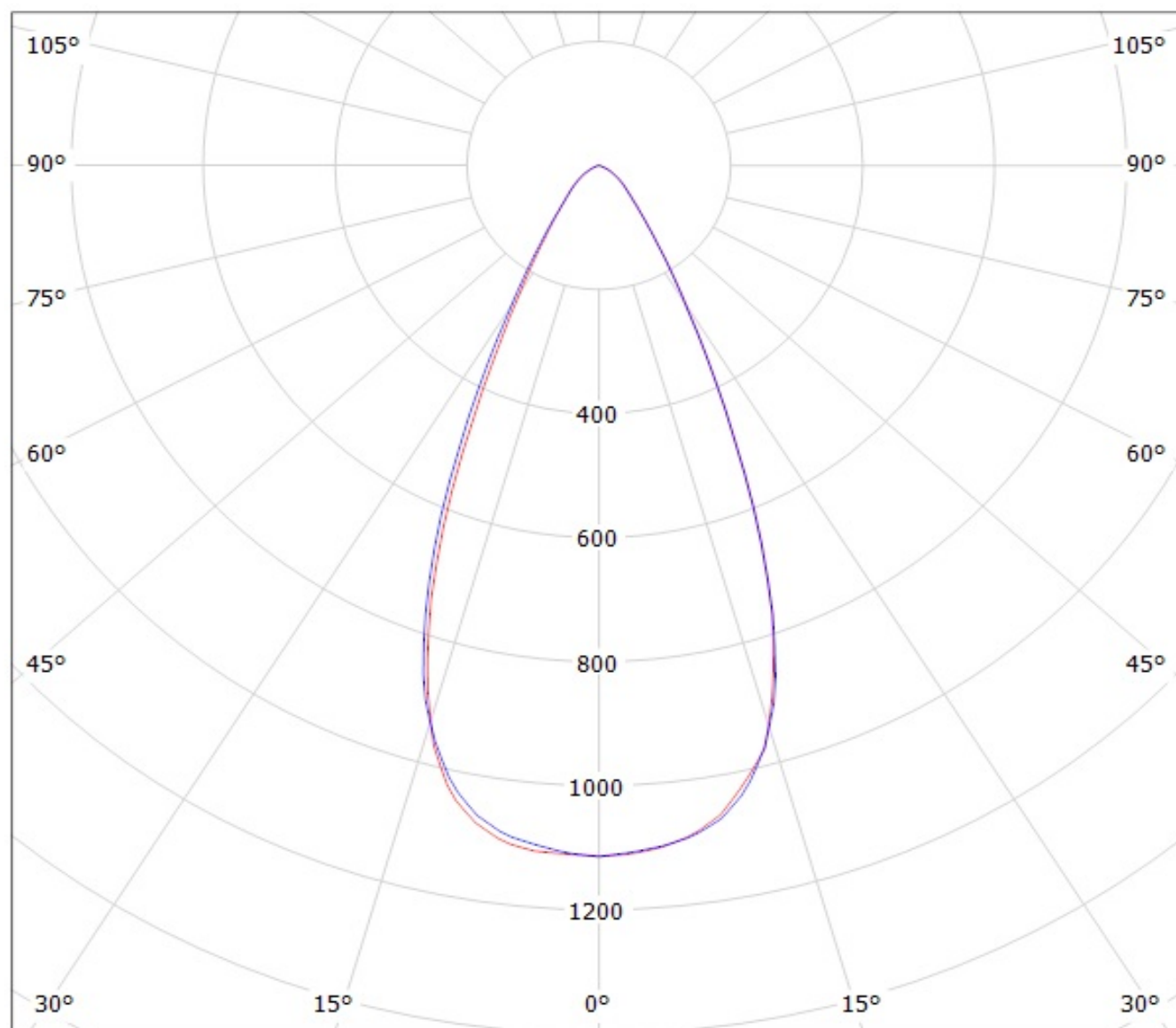

cd/klm

— C0 - C180

— C90 - C270

Luminaire: LEDiL Oy C12361_HB-2X2-W_(NS9x383) Eff. 86%
Lamps: 1 x Nichia NS9x383 (288lm@250mA)

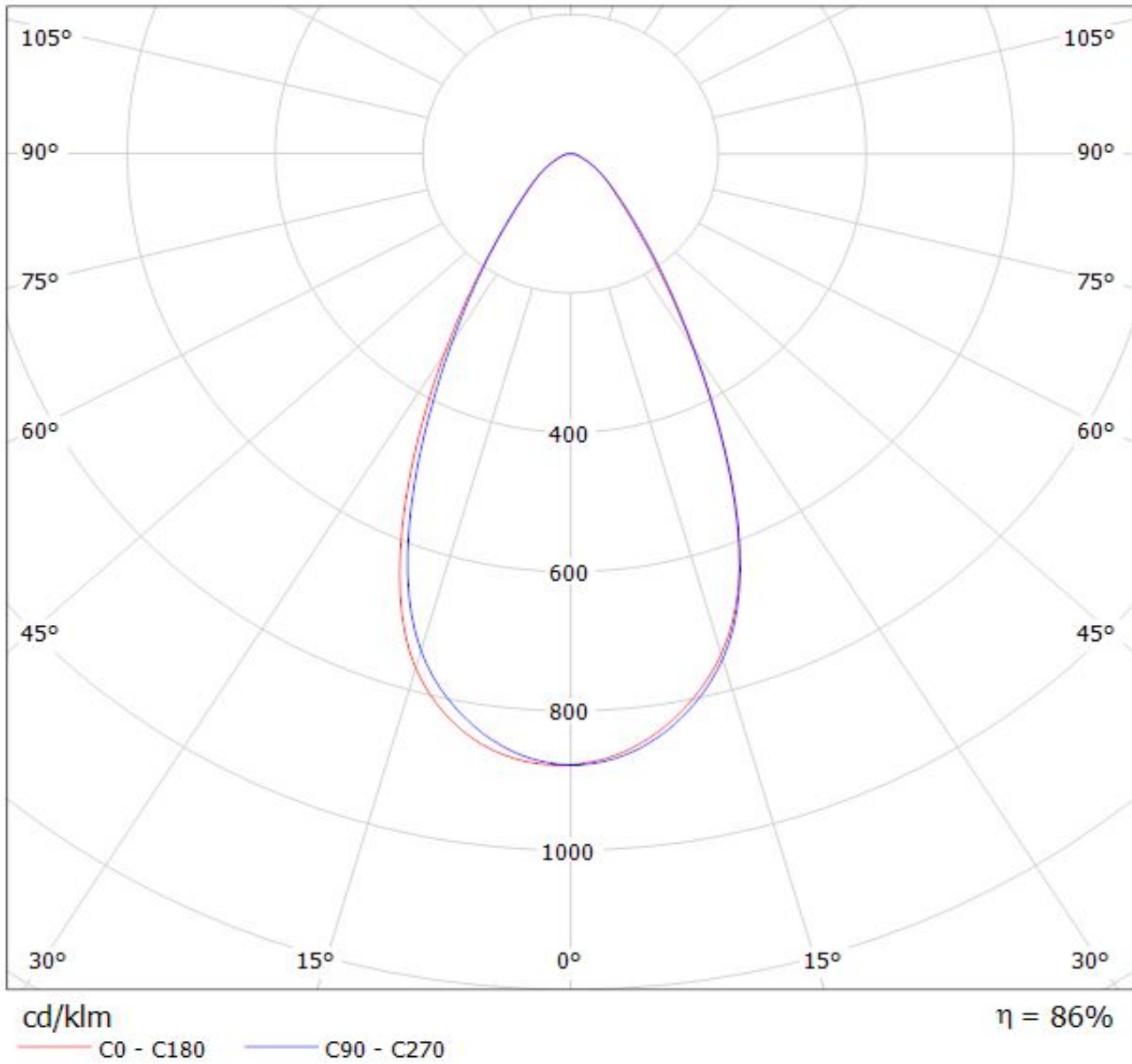

Luminaire: Ledil Oy C12361_HB-2X2-W_(NVS19B) Efficiency=85%
Lamps: 1 x Nichia NVS19B (NVSL219BE) 308lm @ 250mA CCT= P=2.89W I=250mA

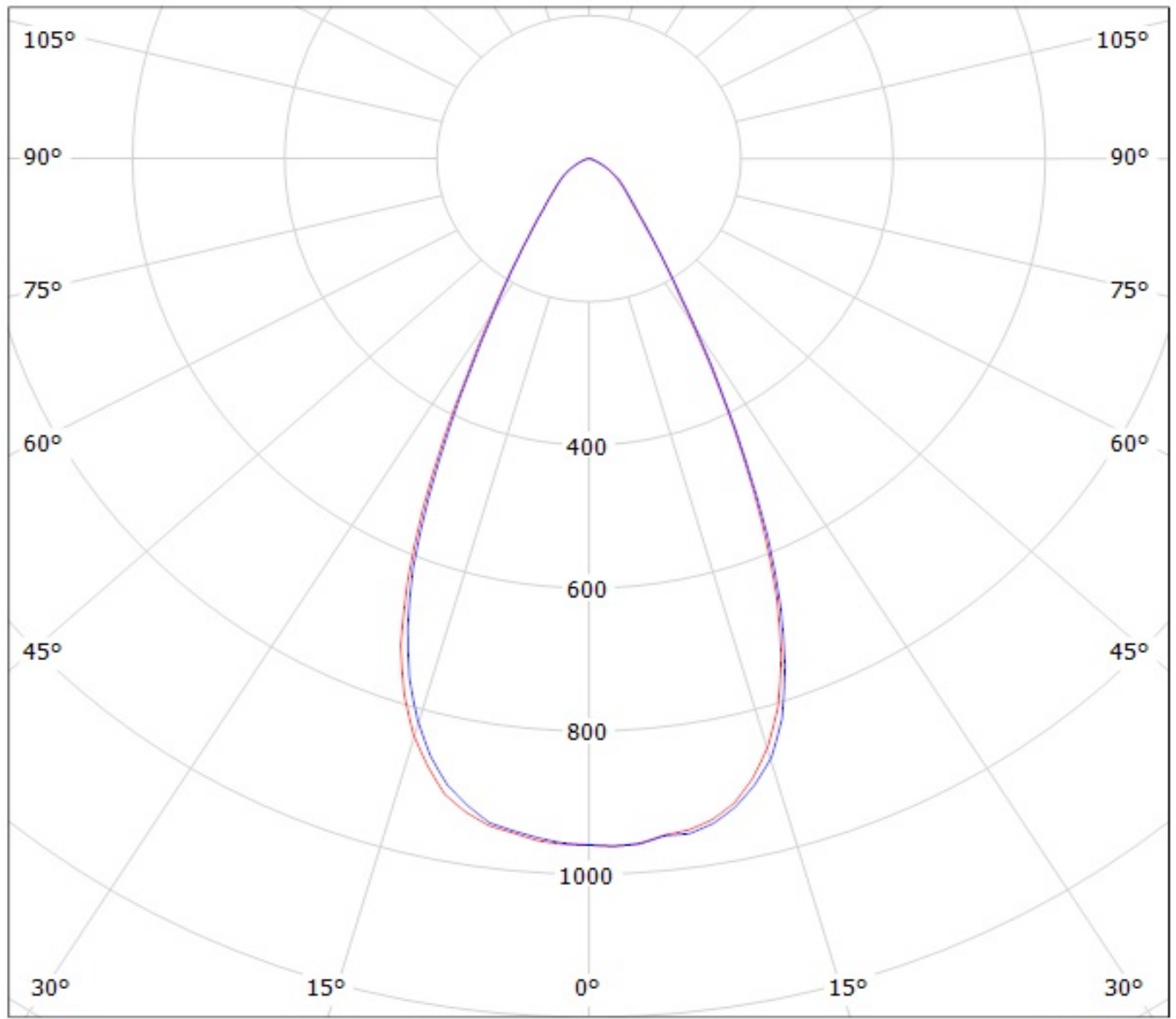

cd/klm

$\eta = 86\%$

— C0 - C180 — C90 - C270

Luminaire: LEDil Oy C12361_HB-2x2-W_(NCSxx19B) Efficiency=85%

Lamps: 1 x Nichia NCSxx19b (NCSW119BE) 425lm @ 250mA CCT=5400K P=3.1W I=250mA

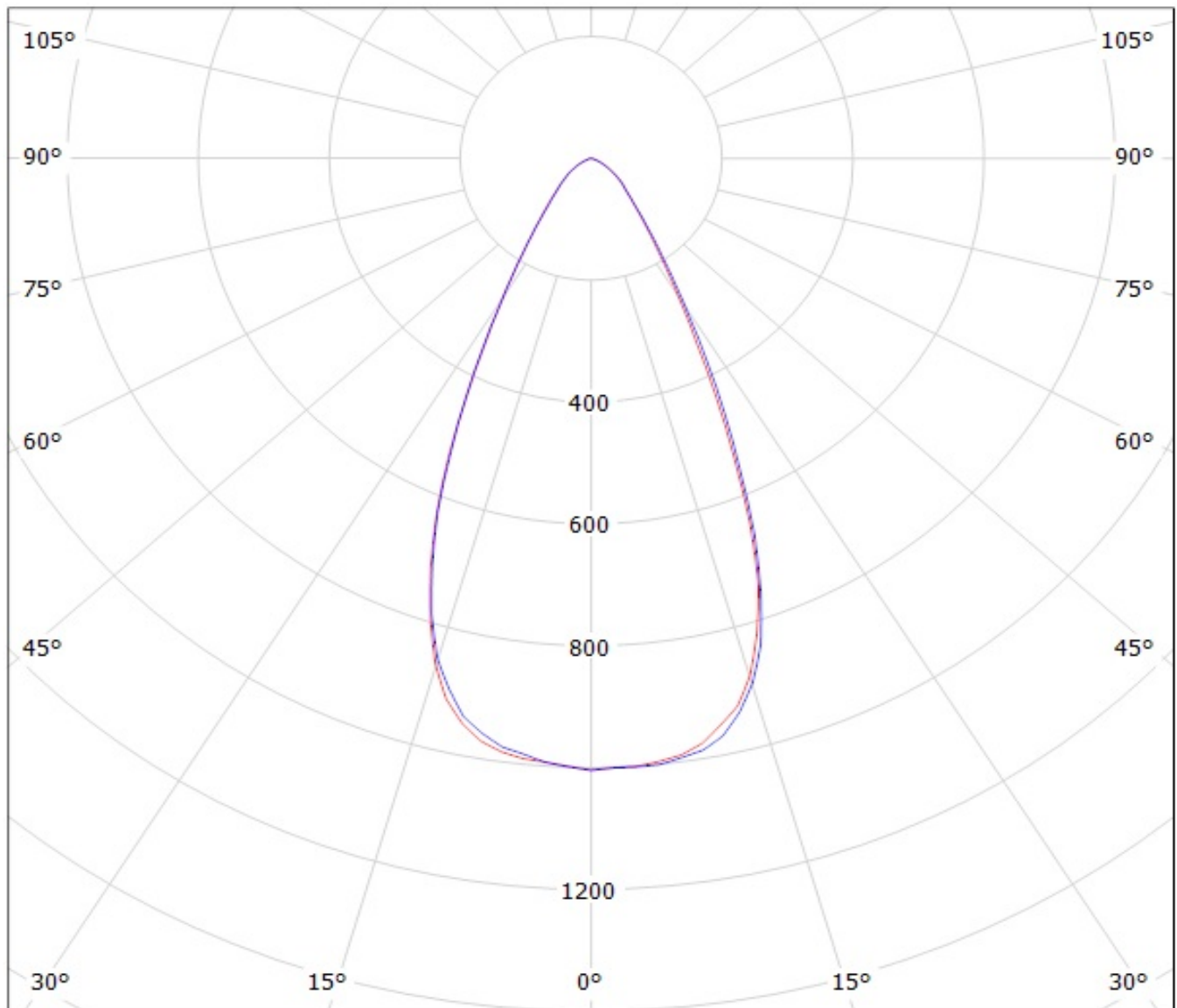

cd/klm

— C0 - C180

— C90 - C270

Luminaire: LEDiL Oy C12361_HB-2X2-W_(NWSL229AE)

Lamps: 1 x Nichia_2X2_NWSL229AE_476.548lm@250mA_P=2.7515W_I=0.250A

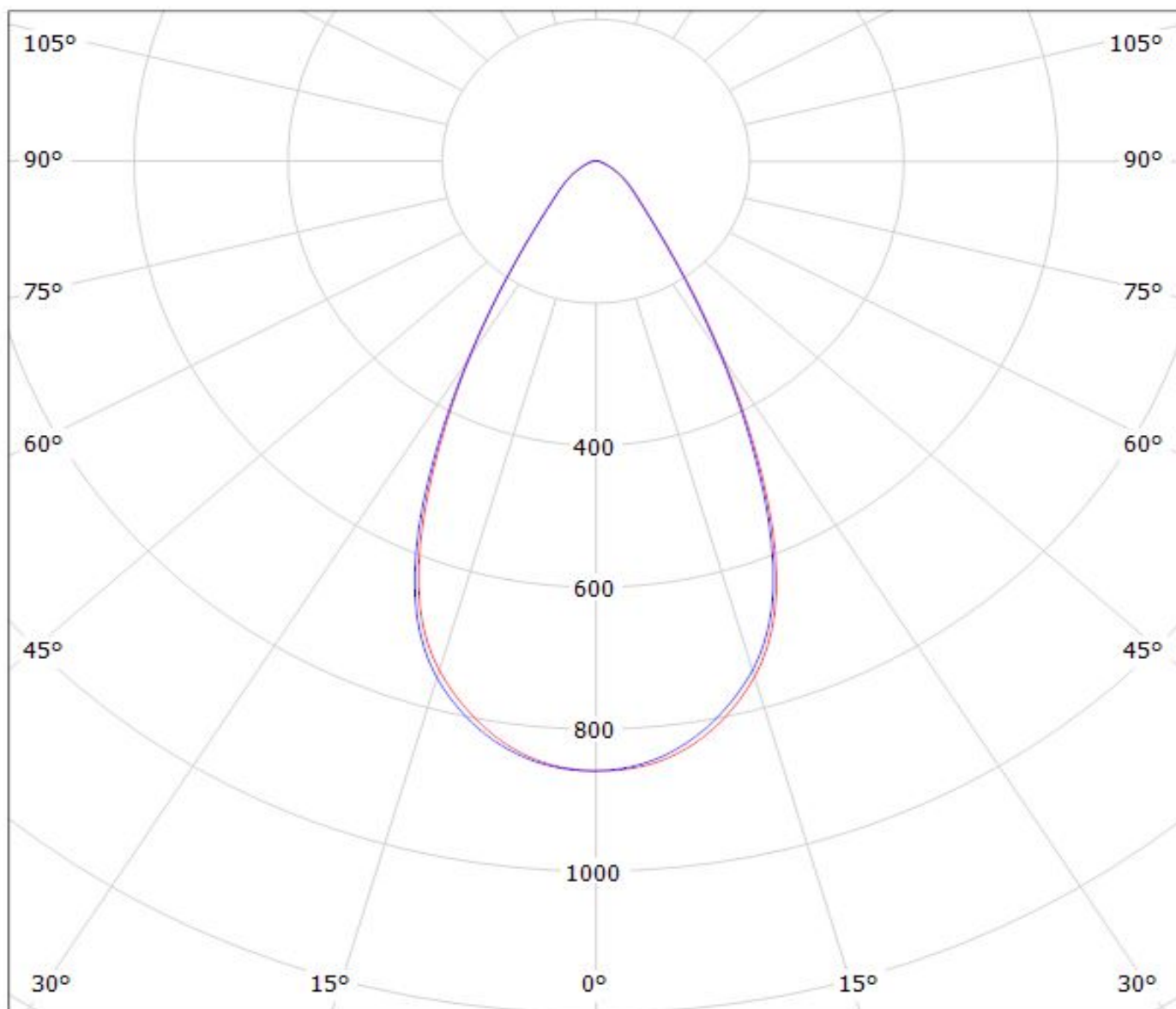

cd/klm

— C0 - C180

— C90 - C270

$\eta = 86\%$

Luminaire: LEDiL Oy C12361_HB-2X2-W_(NVSW3x9A)

Lamps: 1 x Nichia_NVSW3x9A_(sm405/R70)_483.482lmP=2.75904W_I=0.250A

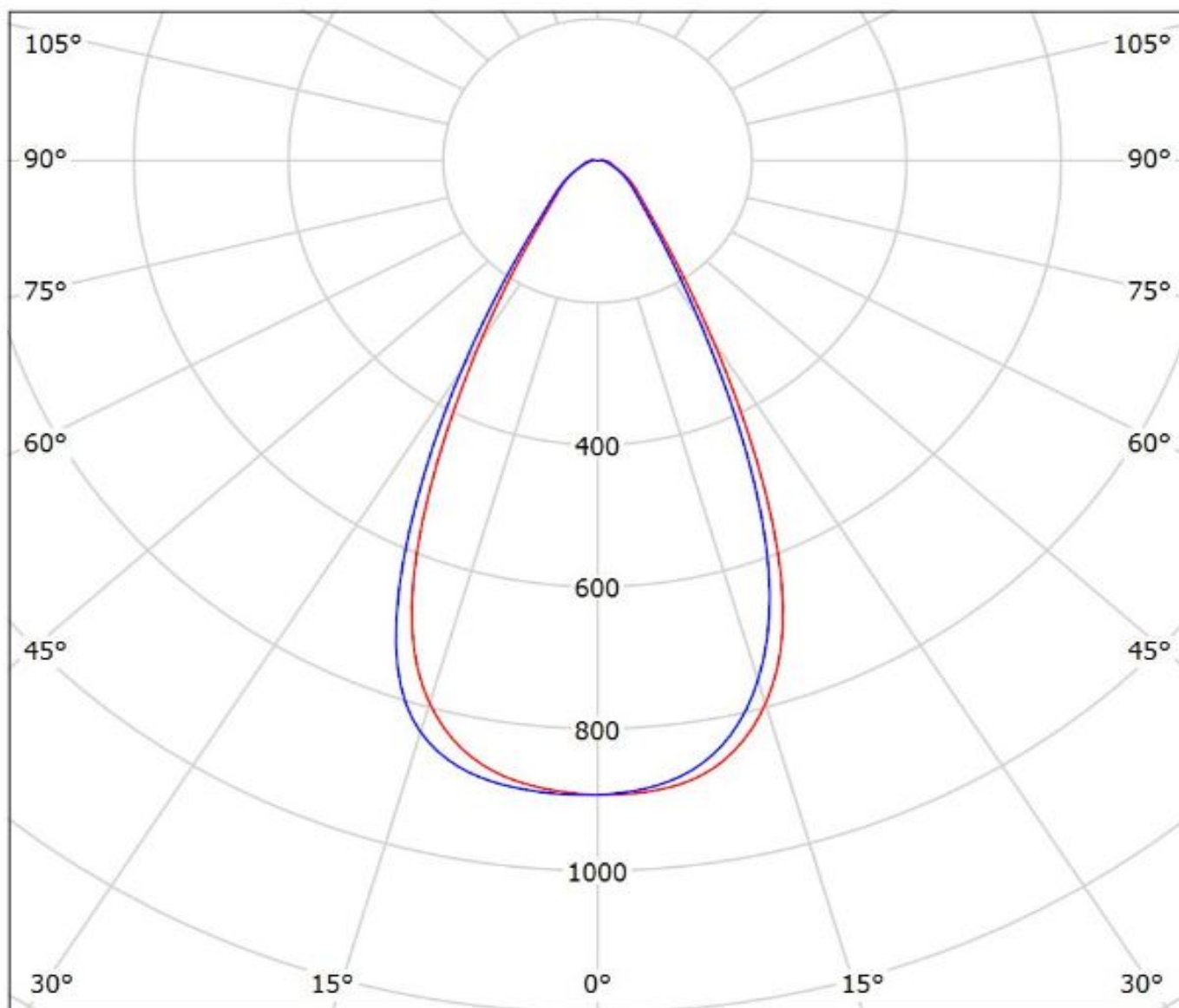

cd/klm

— C0 - C180 — C90 - C270

$\eta = 92\%$

Luminaire: LEDiL Oy C12361_HB-2X2-W_(E21A)

Lamps: 1 x Nichia_E21A_2X2_454.11lm@250mA_P=2.81W_I=0.250A

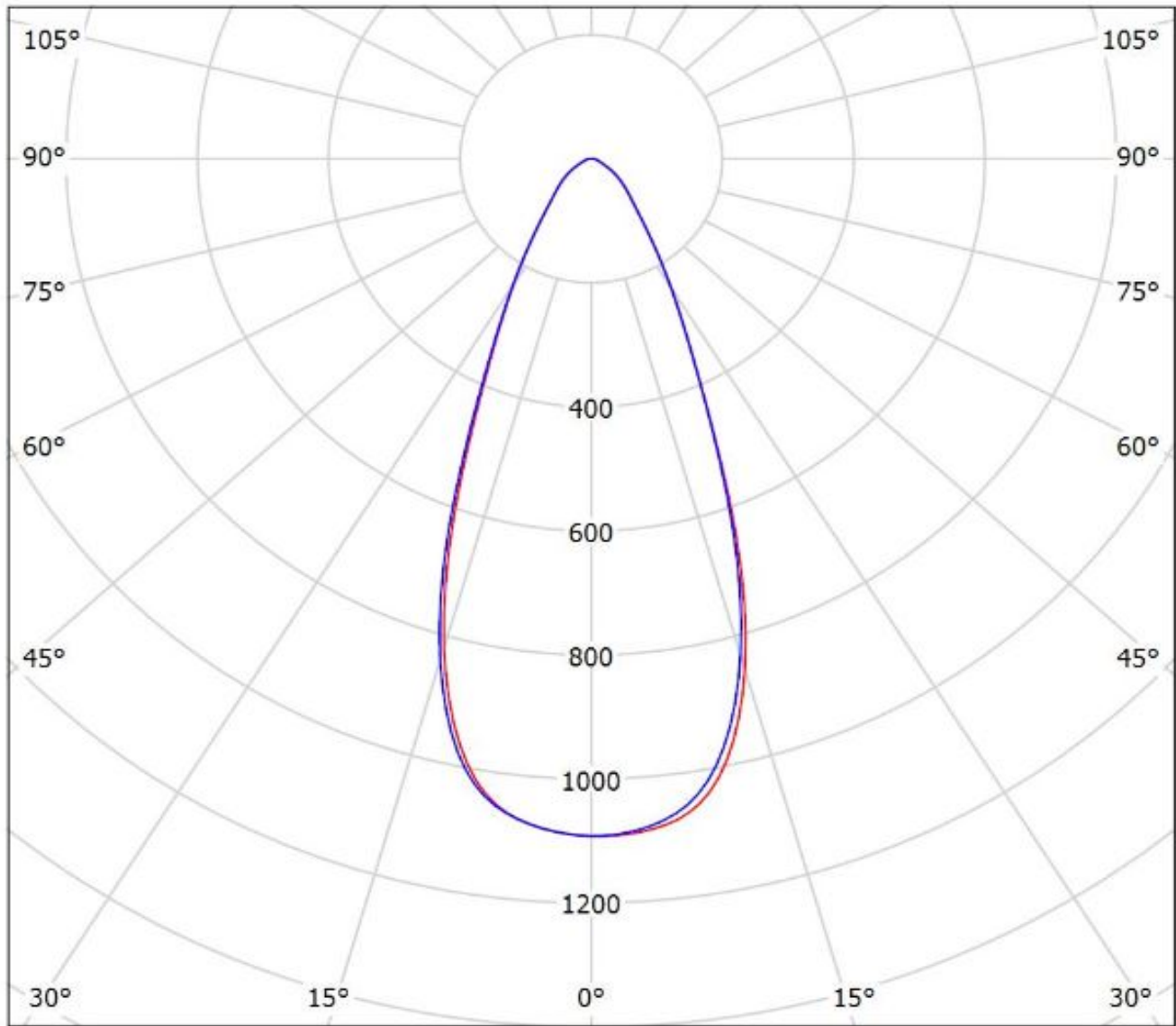

cd/klm

— C0 - C180

— C90 - C270

$\eta = 86\%$

Luminaire: LEDiL Oy C12361_HB-2X2-W_(OLP-5065F6L-06A) Eff.88.5%
Lamps: 1 x OPTOGAN_2x2_(OLP-5065F6L-06A-80-D05O0) 423.091lm@250mA CCT=5000K P=2.98506W I=249.9mA

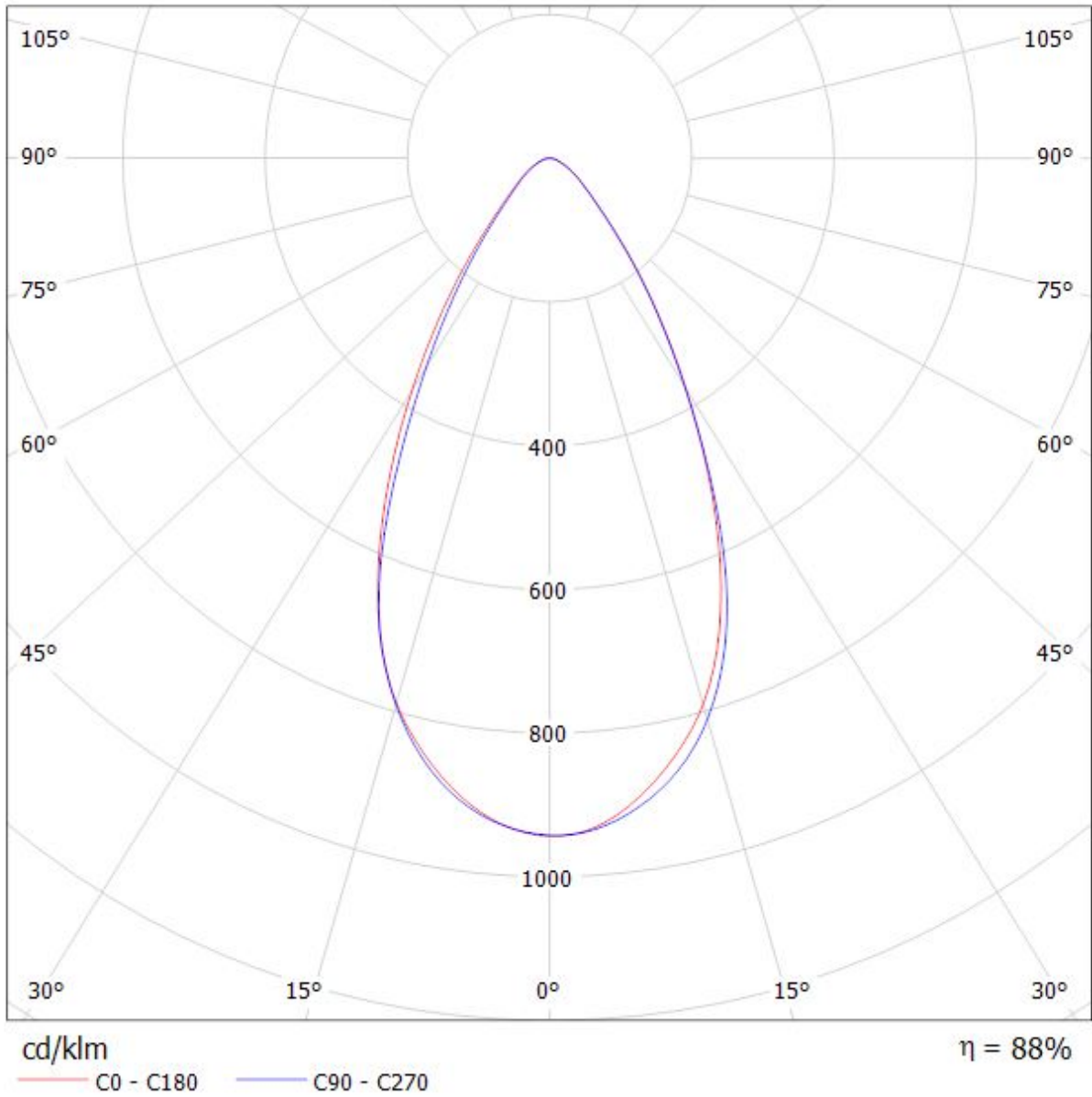

Luminaire: LEDIL OY C12361_HB-2X2 (SSL80) Efficiency=89%
Lamps: 1 x Osram SSL80 (340lm @ 250mA)

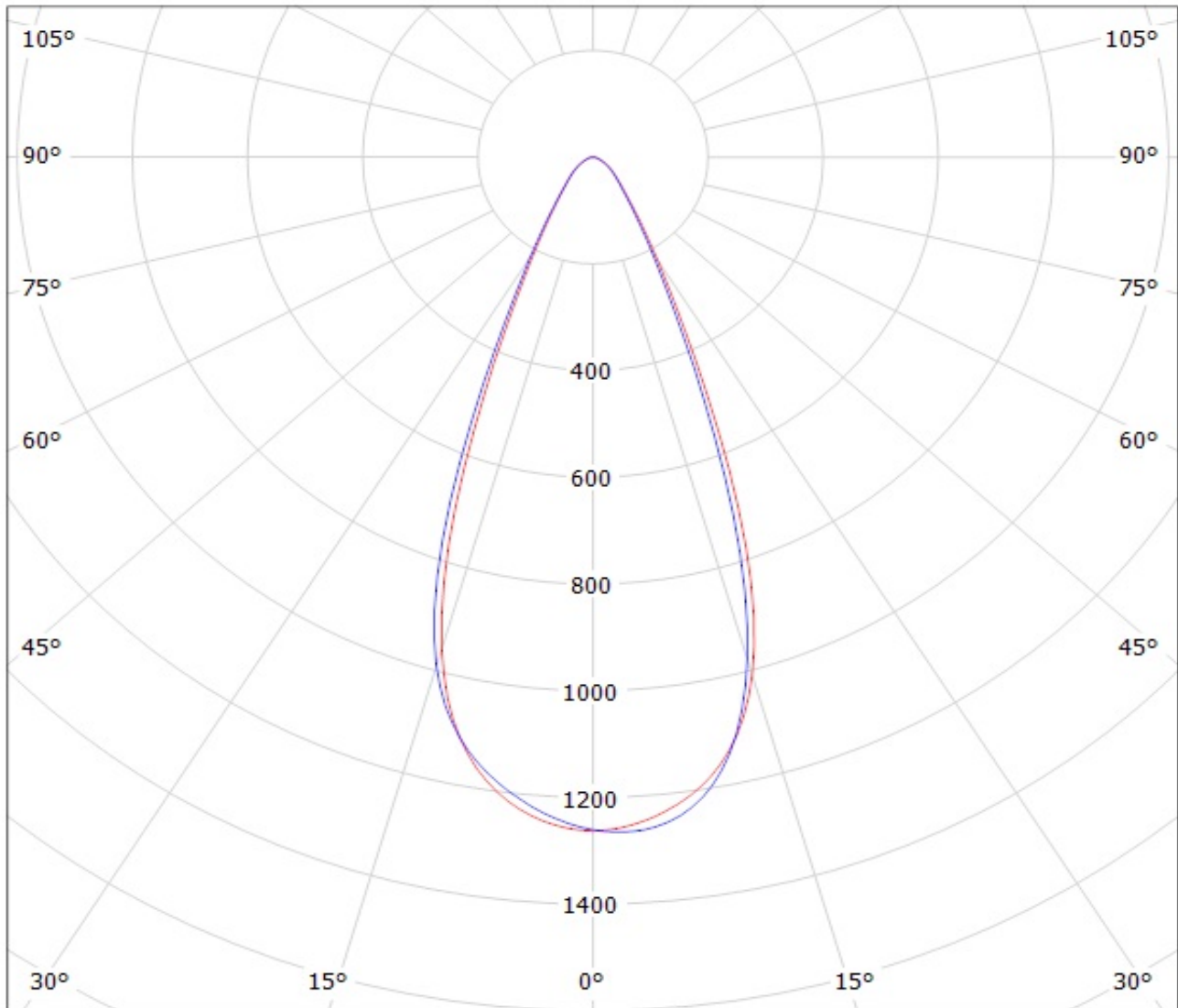

cd/klm
— C0 - C180 — C90 - C270

Luminaire: LEDIL OY C12361_HB-2X2_(SQ_PC) Efficiency=87%
Lamps: 1 x OSLOM SQUARE PC (400.6lm)

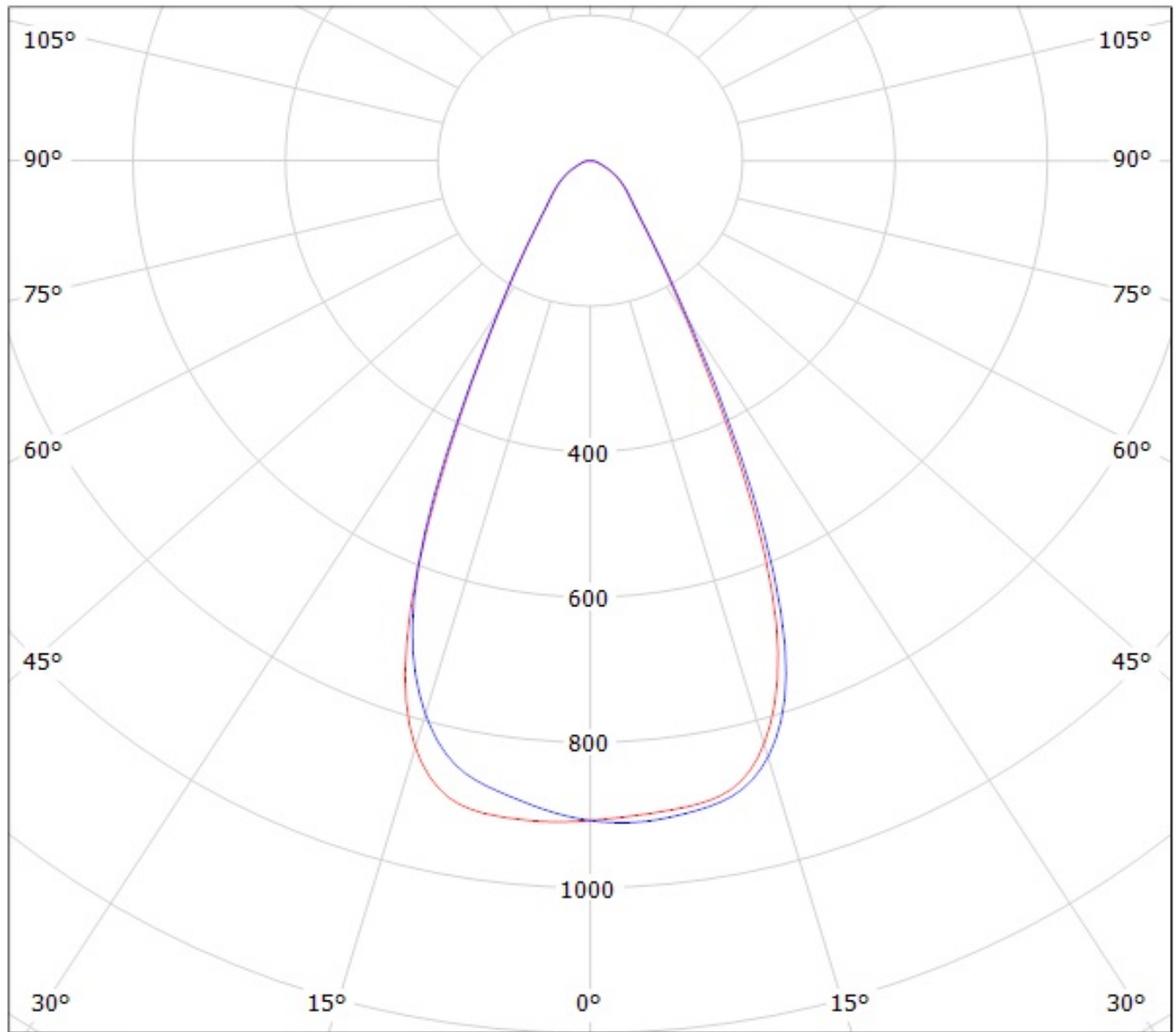

cd/klm

— C0 - C180

— C90 - C270

Luminaire: Ledil Oy C12361_HB-2X2-W_(Duris_P8)_SIMULATED
Lamps: 1 x Osram Duris P8

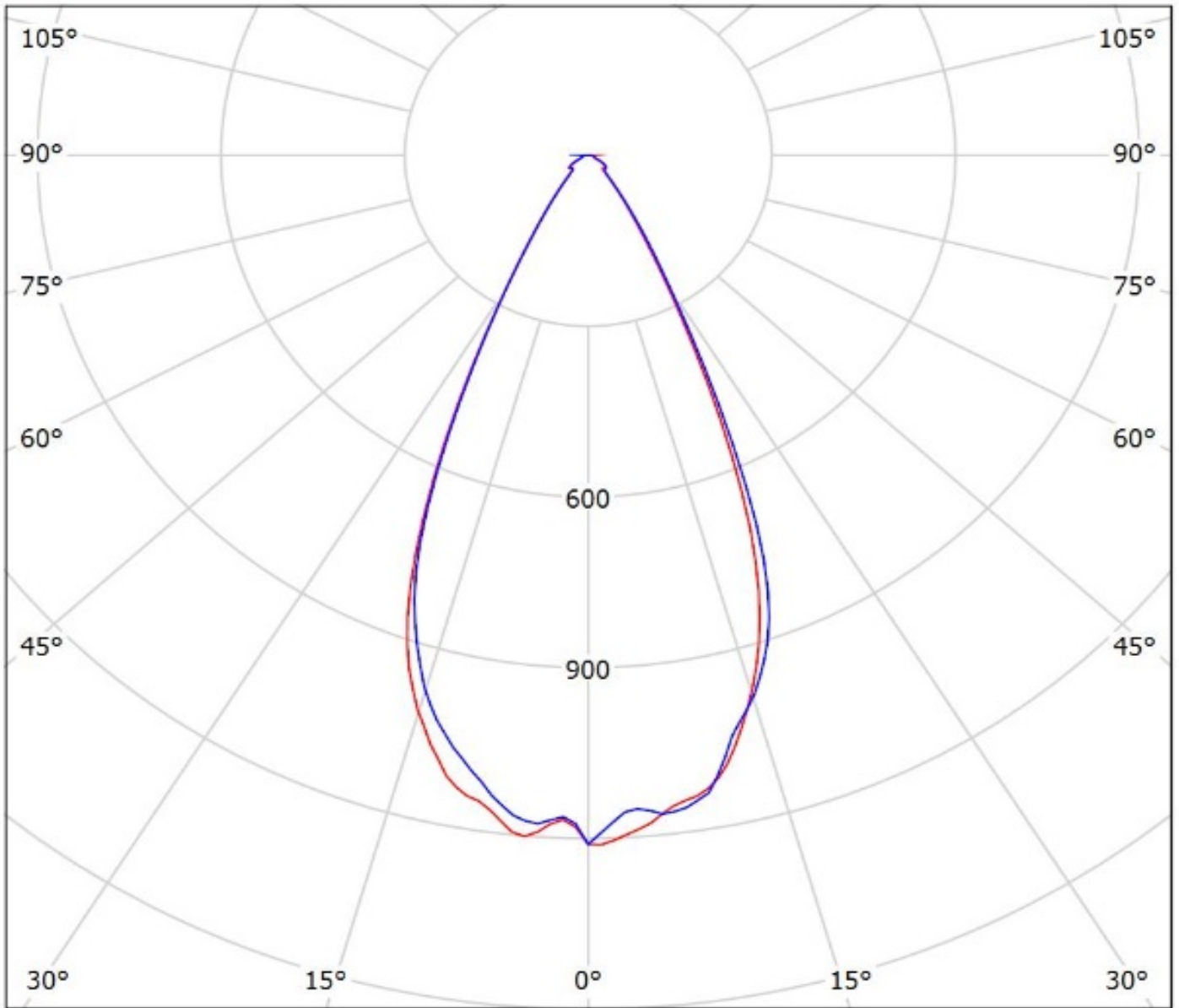

cd/klm
— C0 - C180 — C90 - C270

$\eta = 93\%$

Luminaire: Ledil C12361_HB-2X2-W_(Fortimo_FastFlex_LED_board_2x8/740_DA_G3)

Lamps: 1 x Fortimo_FastFlex_LED_board_2x8/740_DA_G3_1828.23lm@250mA_P=11.667W_I=0.25A

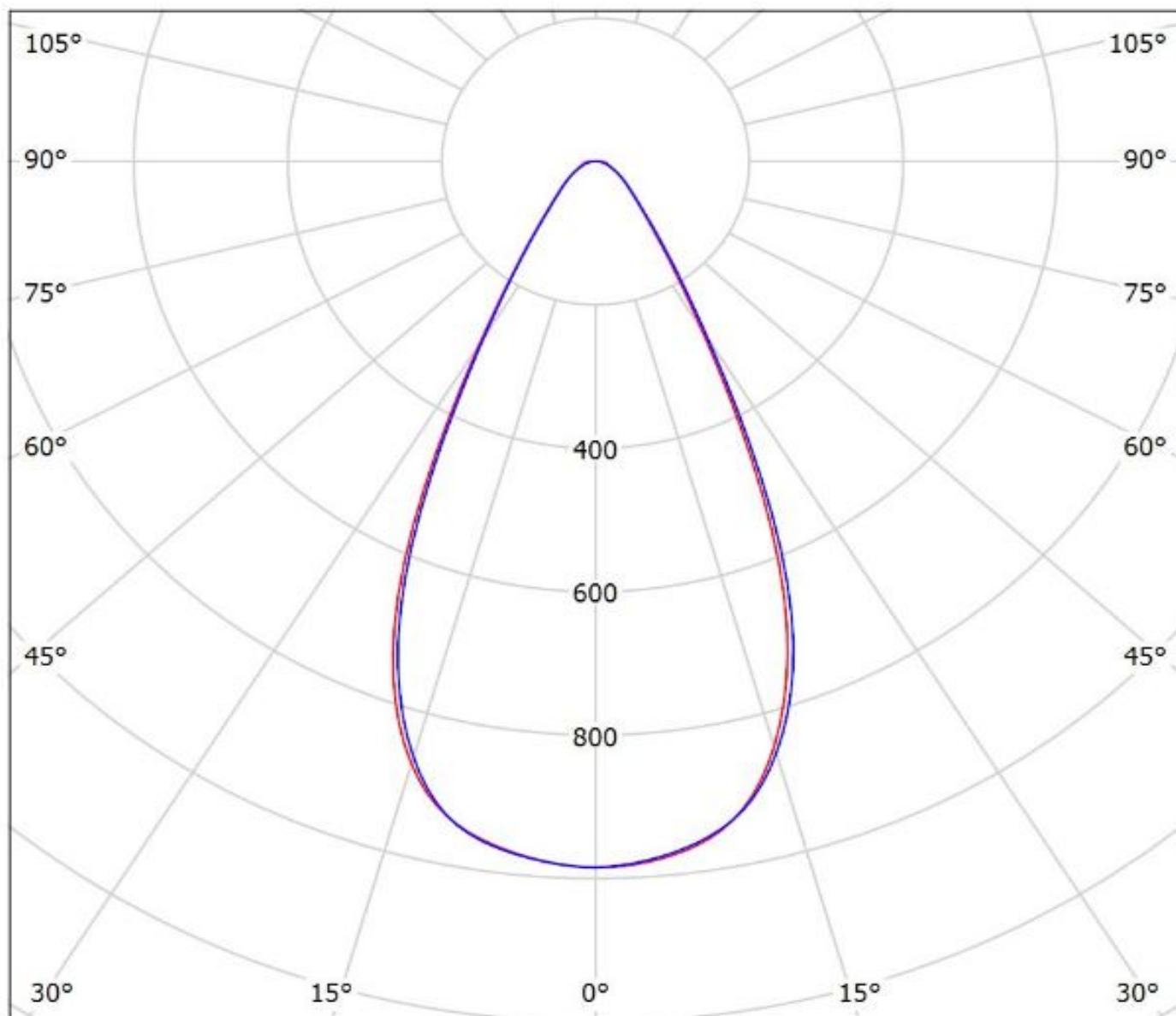

cd/klm

— C0 - C180 — C90 - C270

$\eta = 94\%$

Luminaire: Ledil Oy C12361_HB-2X2-W_(Fortimo_FastFlex_LED_board_2x8_DAX_G4)_SIMULATED
Lamps: 1 x C12361_HB-2X2-W_(Fortimo_FastFlex_LED_board_2x8_DAX_G4)_SIMULATED

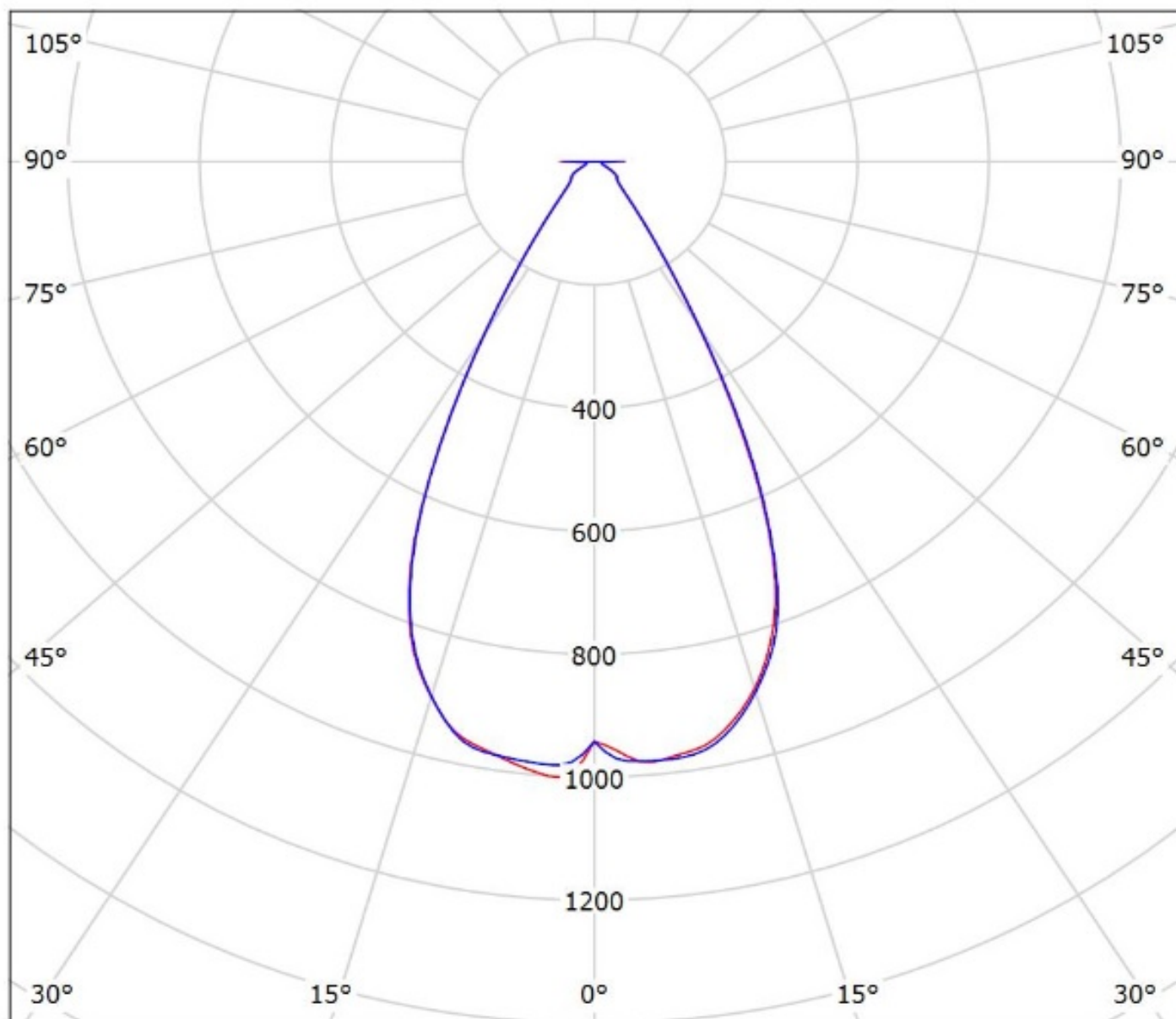

cd/klm

— C0 - C180 — C90 - C270

$\eta = 95\%$

Luminaire: LEDIL OY C12361_HB-2X2 (3535) Efficiency=89%
Lamps: 1 x SAmsung 3535 (353lm @ 250mA)

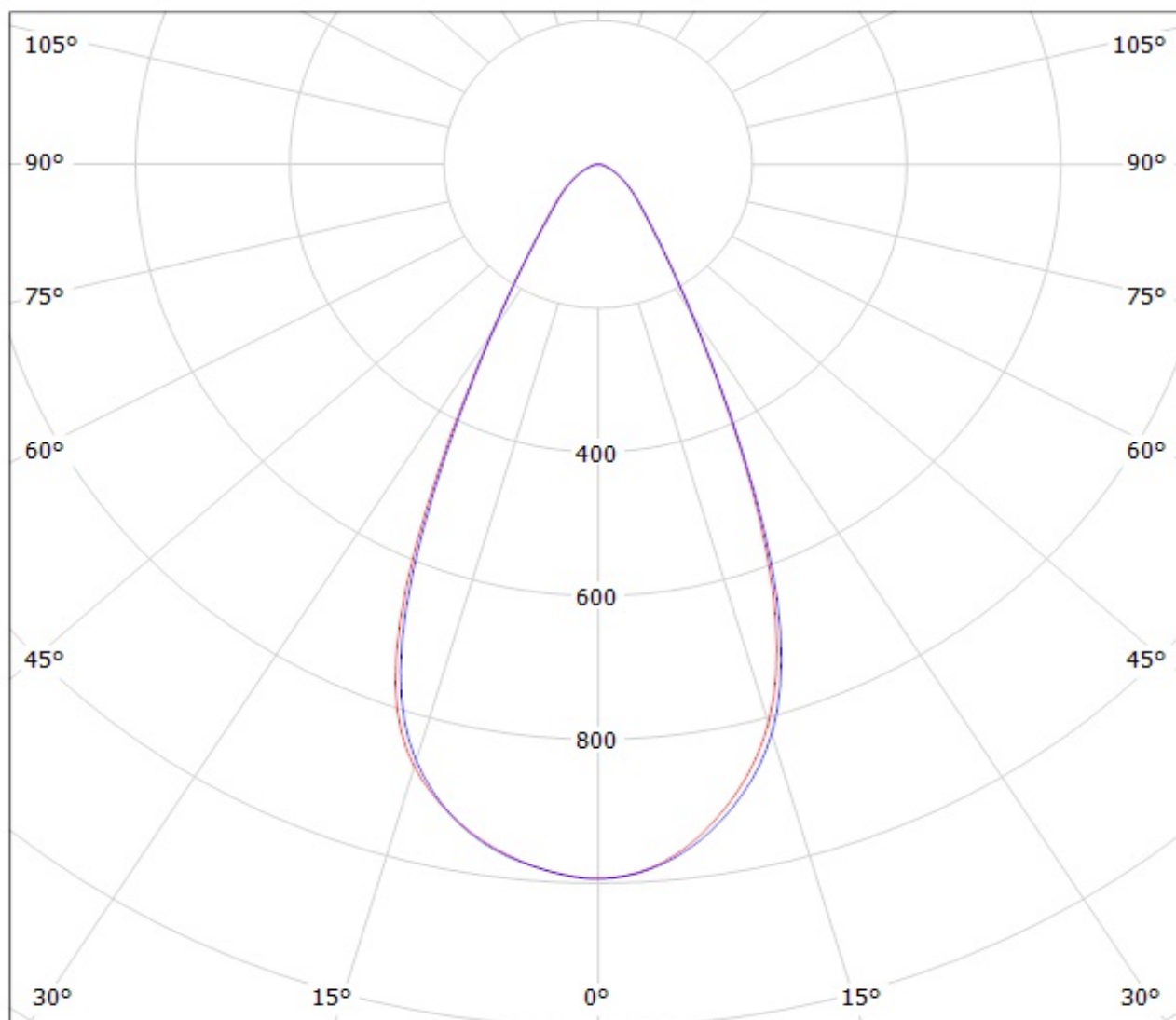

cd/klm

— C0 - C180 — C90 - C270

Luminaire: LEDiL Oy C12361_HB-2X2-W_(LH351Z) Eff.87.4%

Lamps: 1 x SAMSUNG_LH351Z_2x2_359.49lm@250mA_P=2.86371W_I=249.8mA

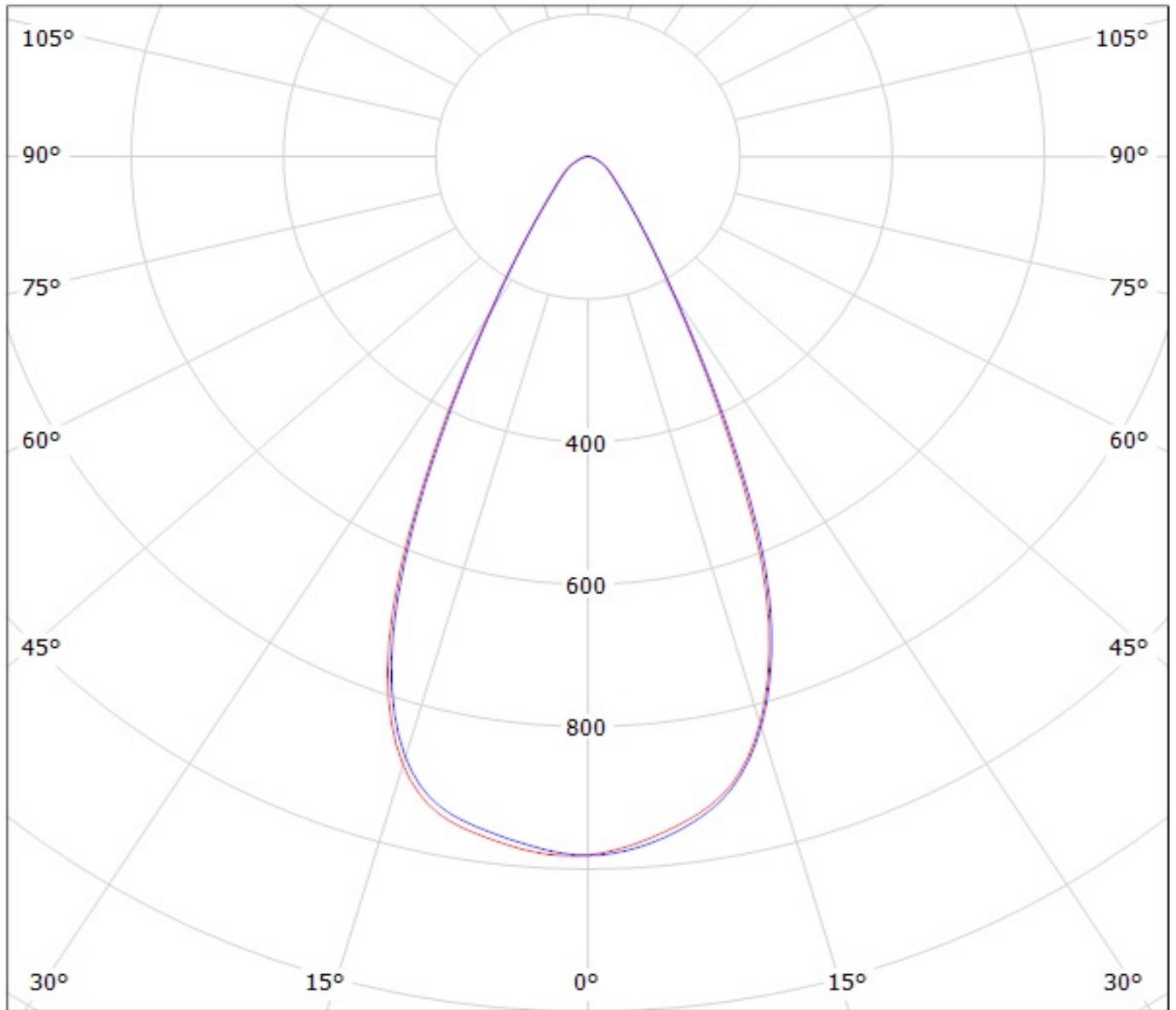

cd/klm

— C0 - C180

— C90 - C270

Luminaire: Ledil C12361_HB-2X2-W_(LH351B)

Lamps: 1 x Samsung_LH351B_2x2_444.178lm@250mA_P=2.8535W_I=0.25A

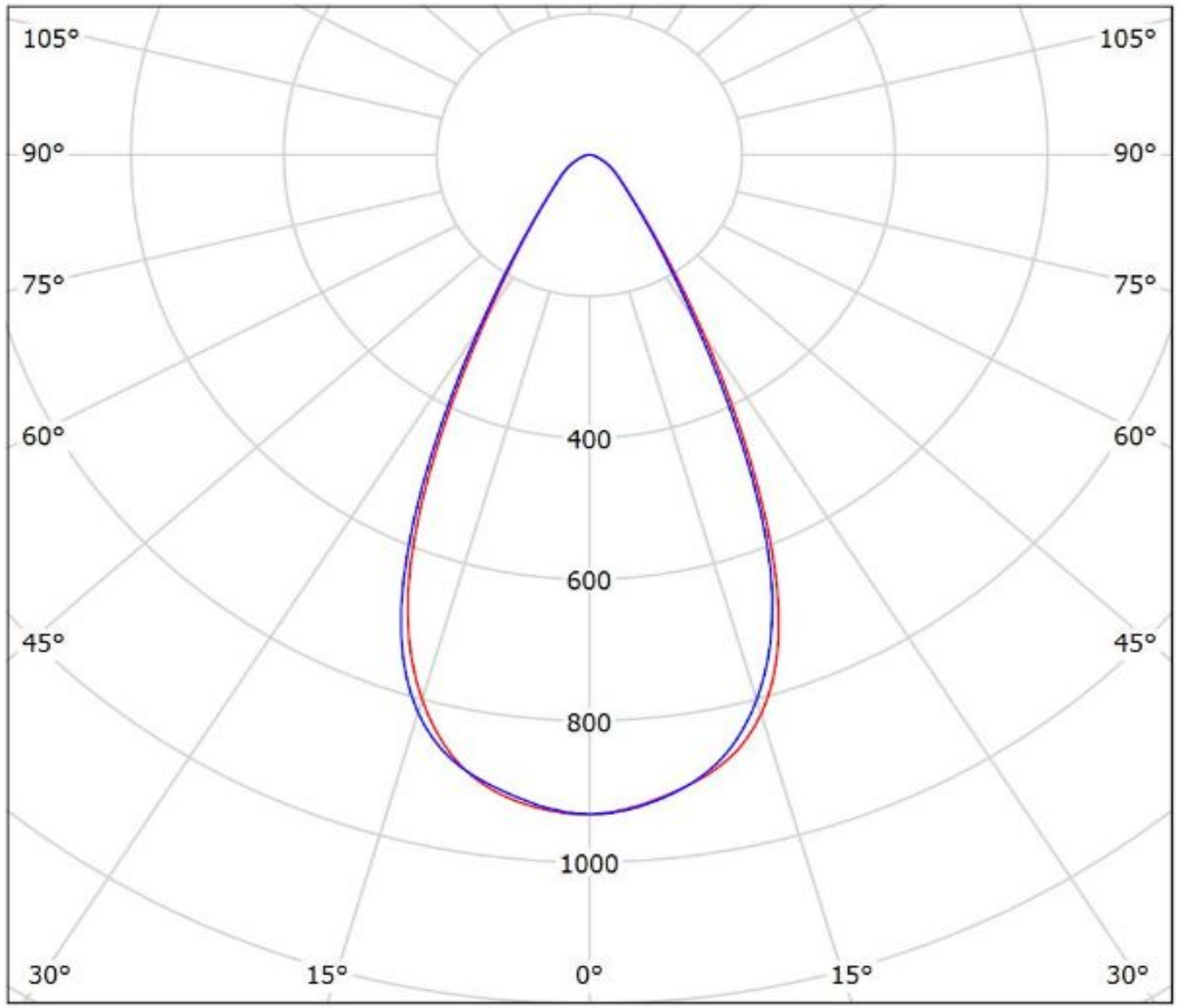

cd/klm

— C0 - C180

— C90 - C270

$\eta = 86\%$

Luminaire: Ledil C12361_HB-2X2-W_(LH351D)

Lamps: 1 x Samsung_LH351D_536.957lm@250mA_P=2.7695W_I=0.250A

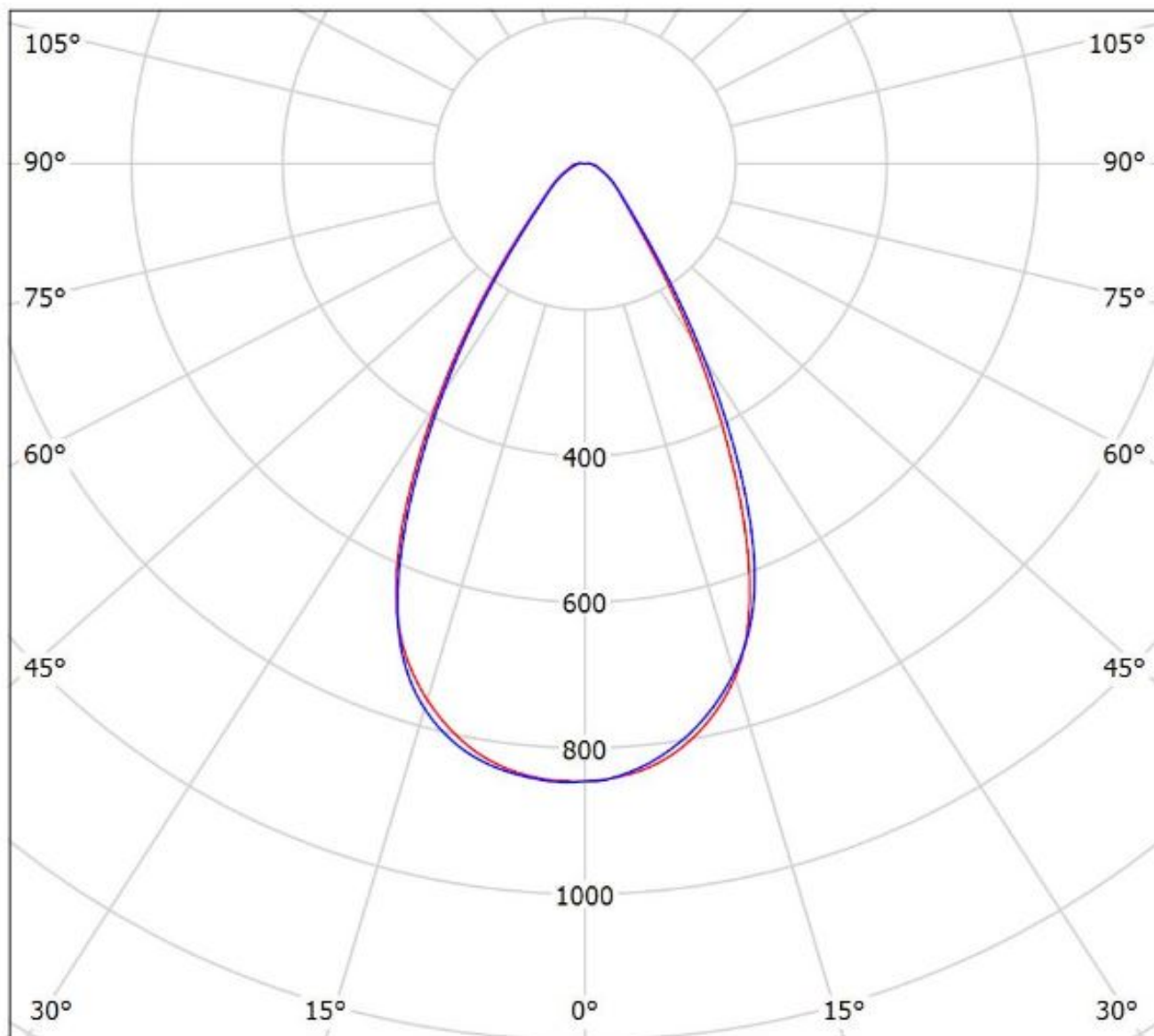

cd/klm

— C0 - C180 — C90 - C270

$\eta = 91\%$

Luminaire: Ledil C12361_HB-2X2-W_(LH351C)

Samsung_LH351C_518.223lm@250mA_P=2.85225W_I=0.25A

Lamps: 1 x Samsung_LH351C_518.223lm@250mA_P=2.85225W_I=0.25A

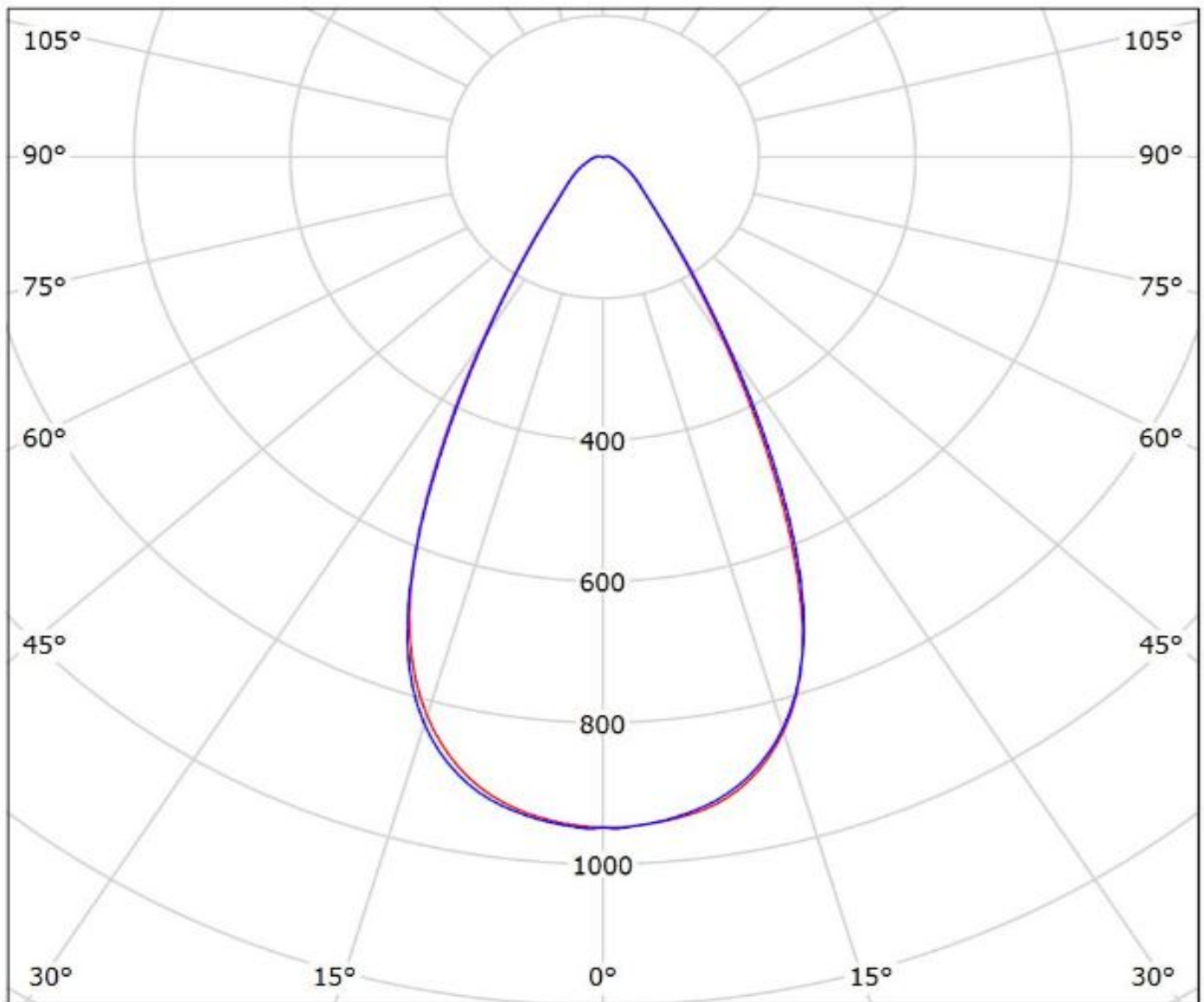

cd/klm

— C0 - C180

— C90 - C270

$\eta = 93\%$

Luminaire: Ledil C12361_HB-2X2-W_(LH508A)

Lamps: 1 x Samsung_LH508A_2x2_2060.04lm@160mA_CCT=5000K_CRI=80_P=15.5405W_I=0.16A

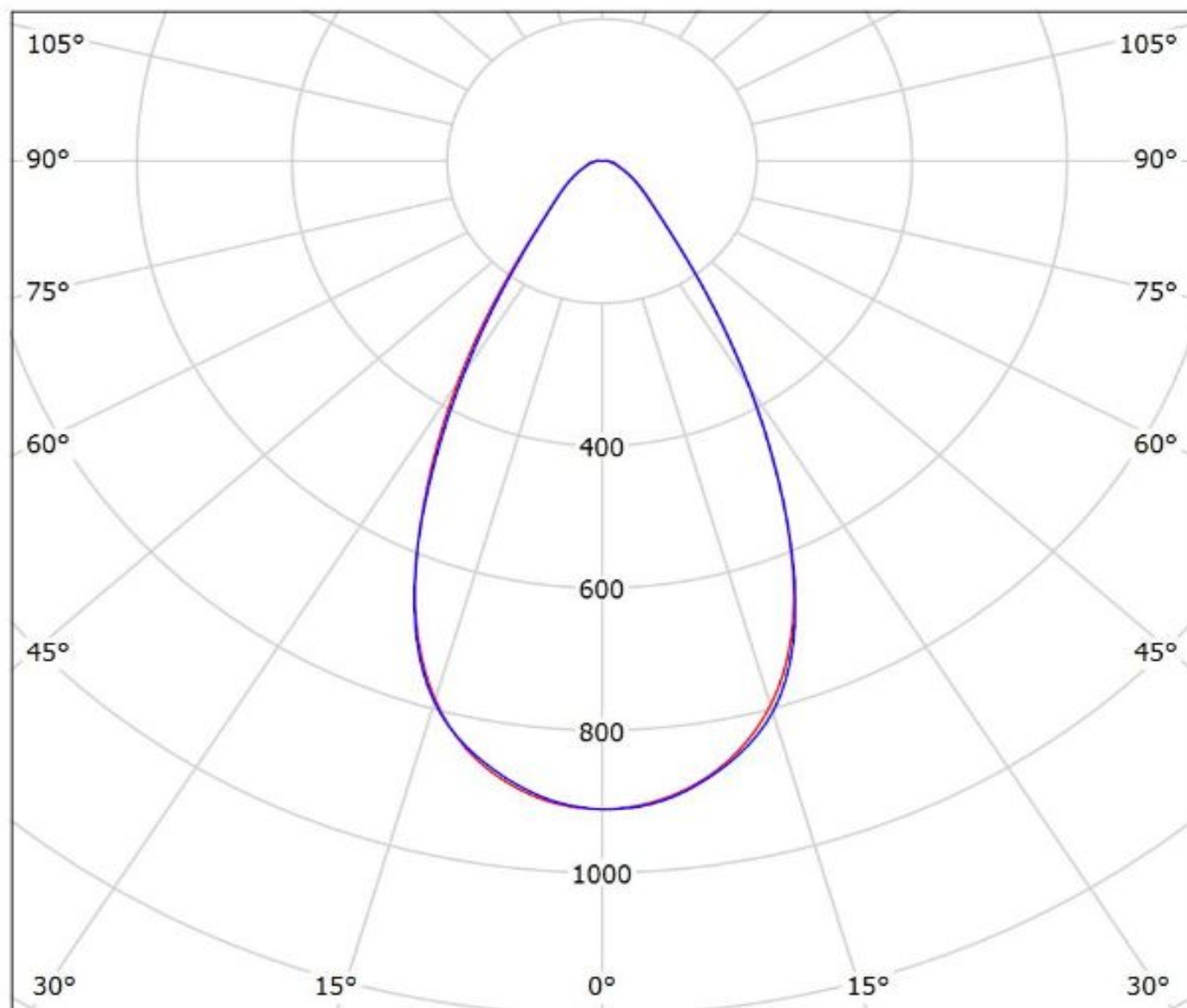

cd/klm

— C0 - C180

— C90 - C270

$\eta = 93\%$

Luminaire: LEDIL OY C12361_HB-2X2 (Z5) Efficiency=88%

Lamps: 1 x Seoul Z5 (290lm @ 250mA)

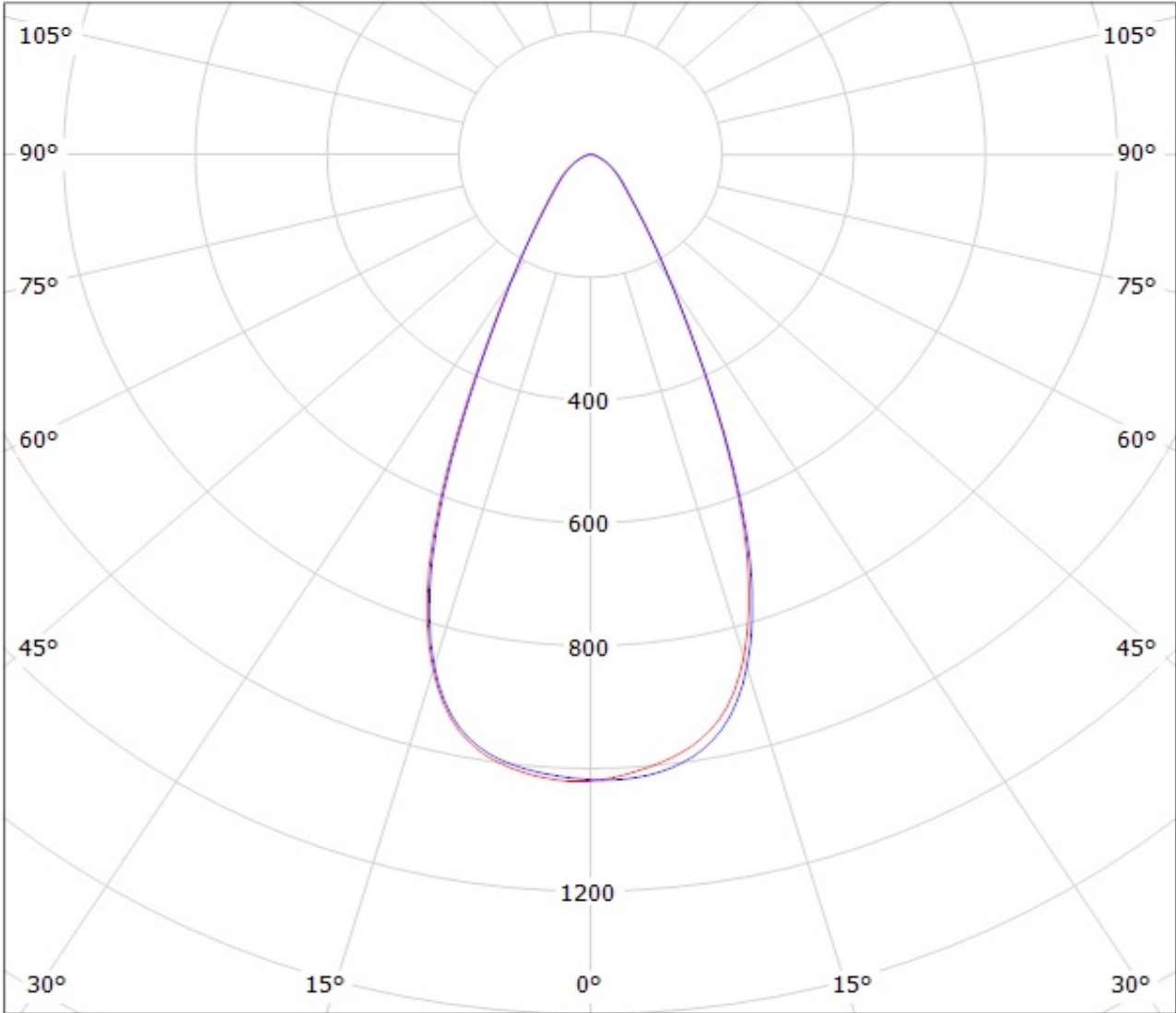

cd/klm

— C0 - C180

— C90 - C270

Luminaire: LEDil Oy C12361_HB-2X2-W_(Z5M1) Efficiency=85%
Lamps: 1 x Seoul Z5M1 (SZ5-M1-WN-C8) 379lm @ 250mA CCT=4600K P=2.9W I=250mA

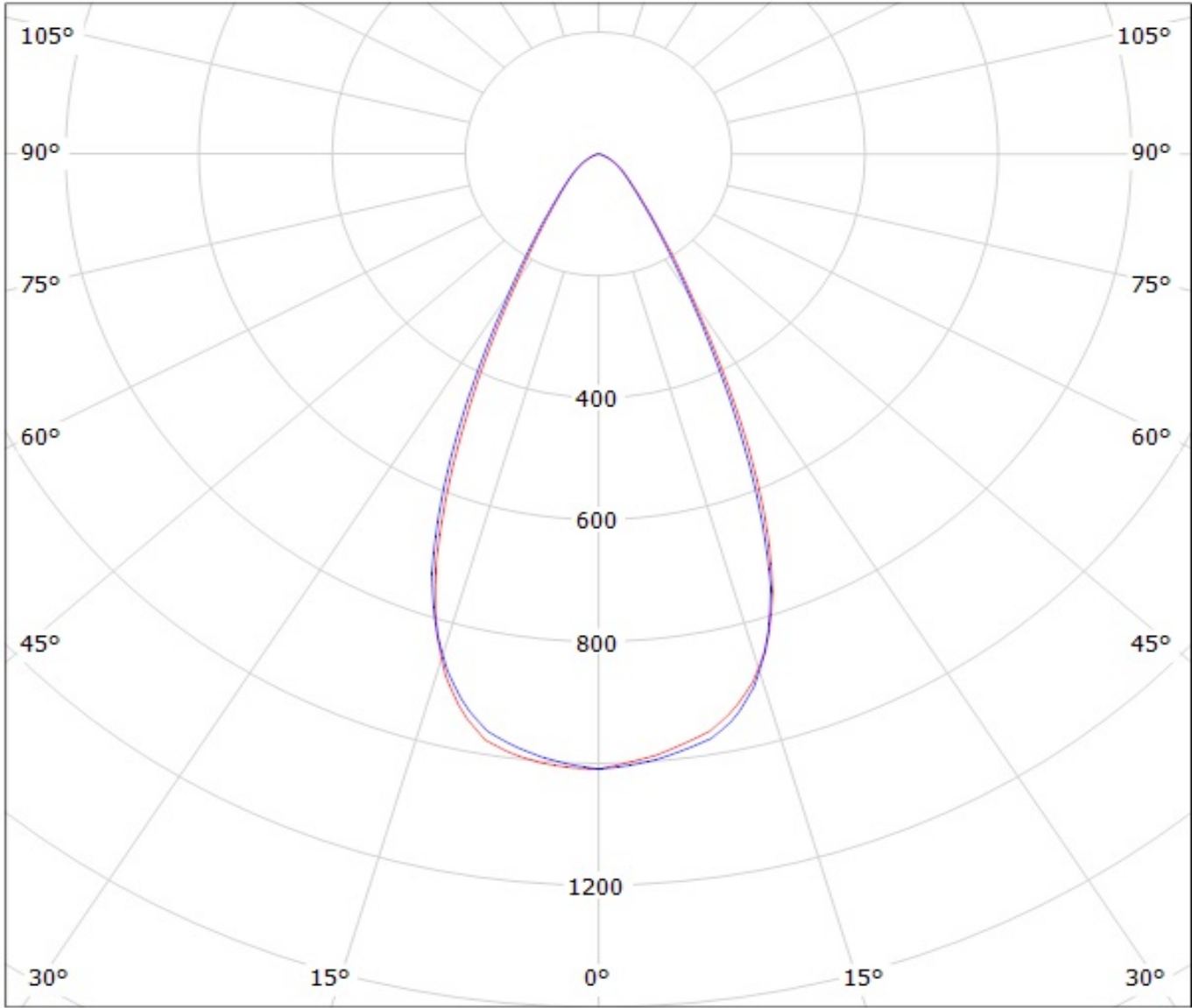

cd/klm

— C0 - C180 — C90 - C270

$\eta = 86\%$

Luminaire: LEDiL Oy C12361_HB-2X2-W_(WICOP2_Z8Y15)

Lamps: 1 x SEOUL_WICOP2_Z8Y15_336.842lm@250mA_P=2.9399W_I=0.250A

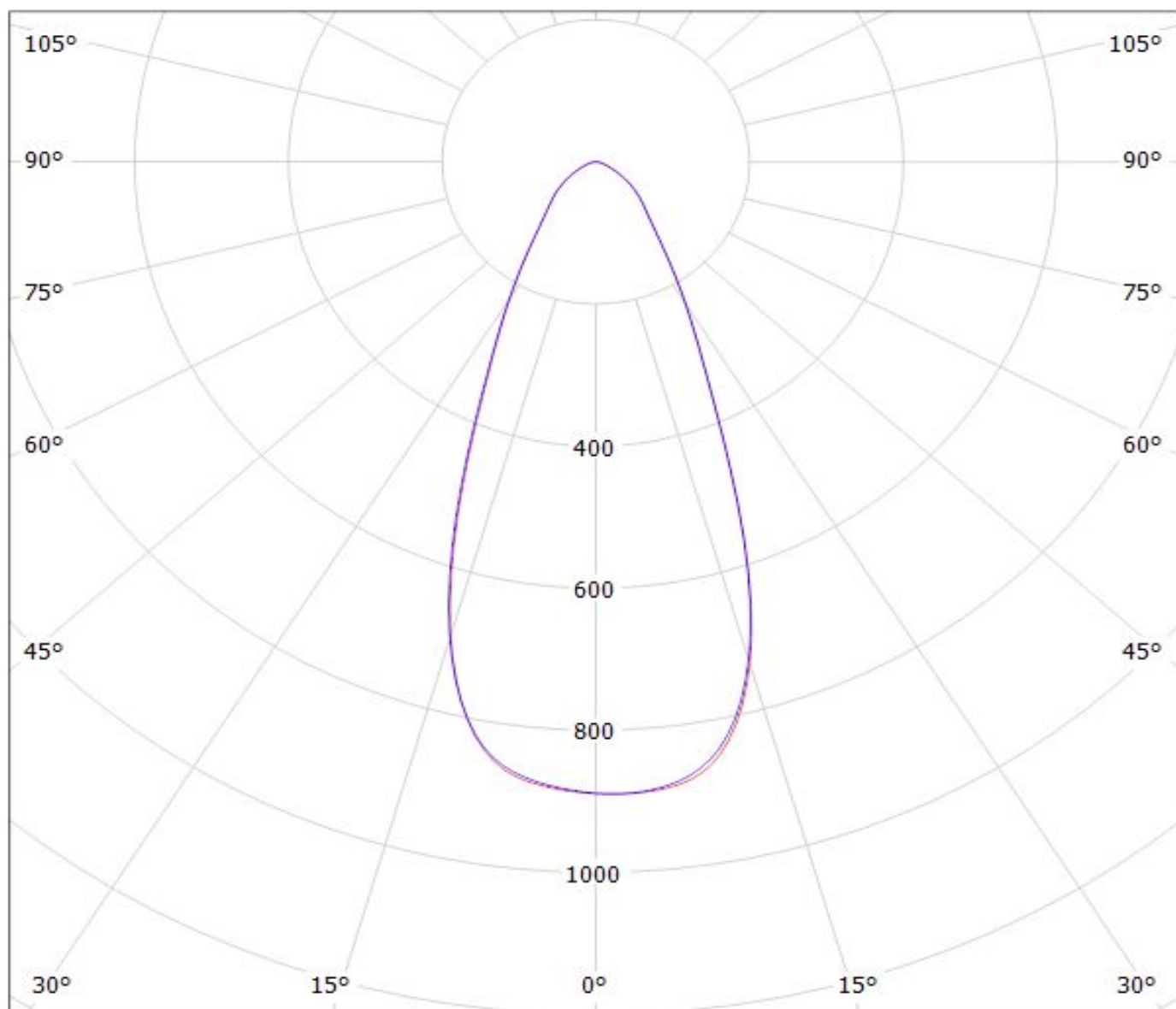

cd/klm

— C0 - C180

— C90 - C270

$\eta = 79\%$

Luminaire: LEDiL Oy C12361_HB-2X2-W_(WICOP2_Z8Y19)

Lamps: 1 x SEOUL_WICOP2_Z8Y19_450.124lm@250mA_P=2.8579W_I=0.250A

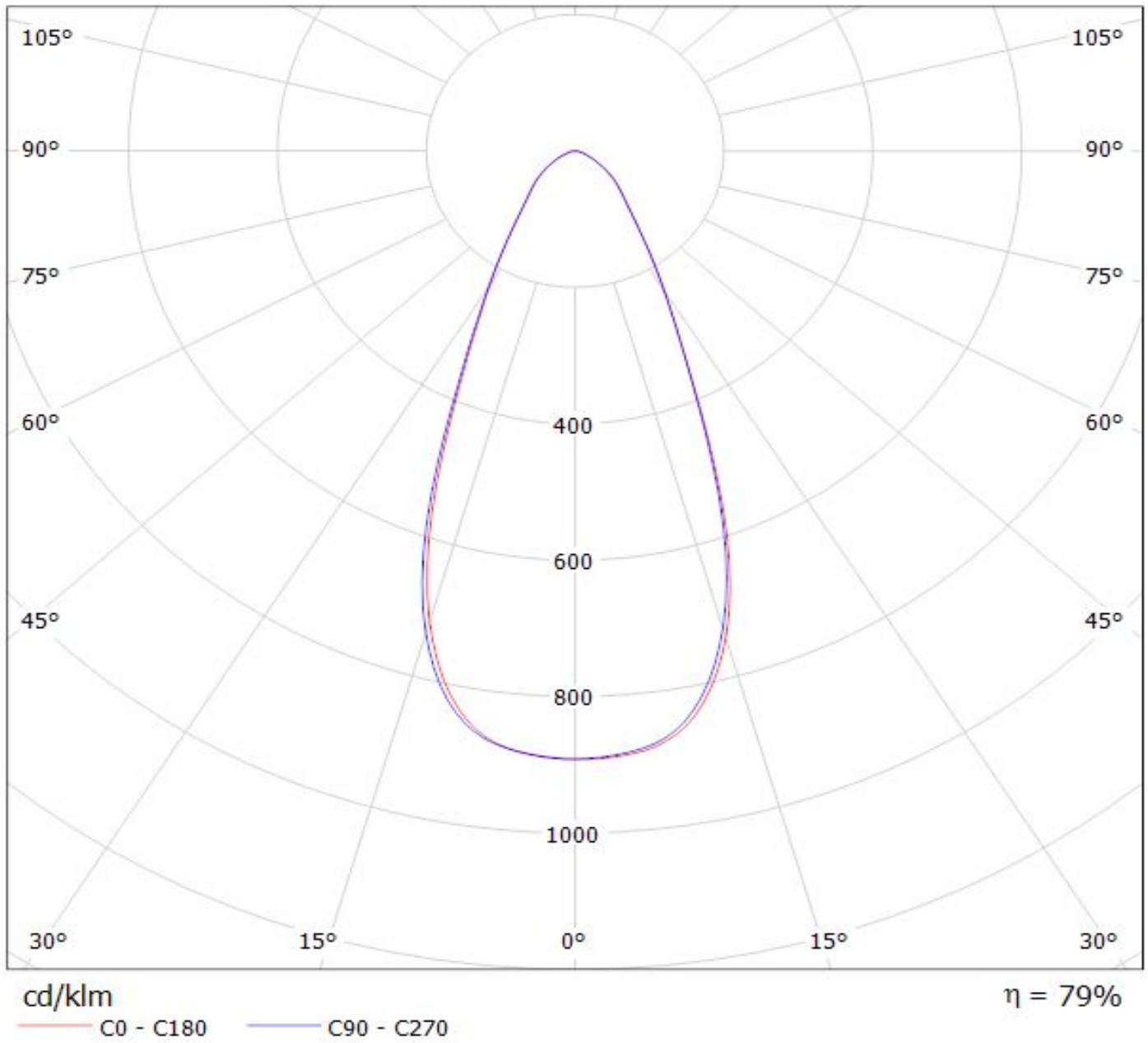

Luminaire: Ledil Oy C12361_HB-2X2-W_(Z5M2)_SIMULATED
Lamps: 1 x Seoul Z5M2 (SZ5-M2-W0-00)

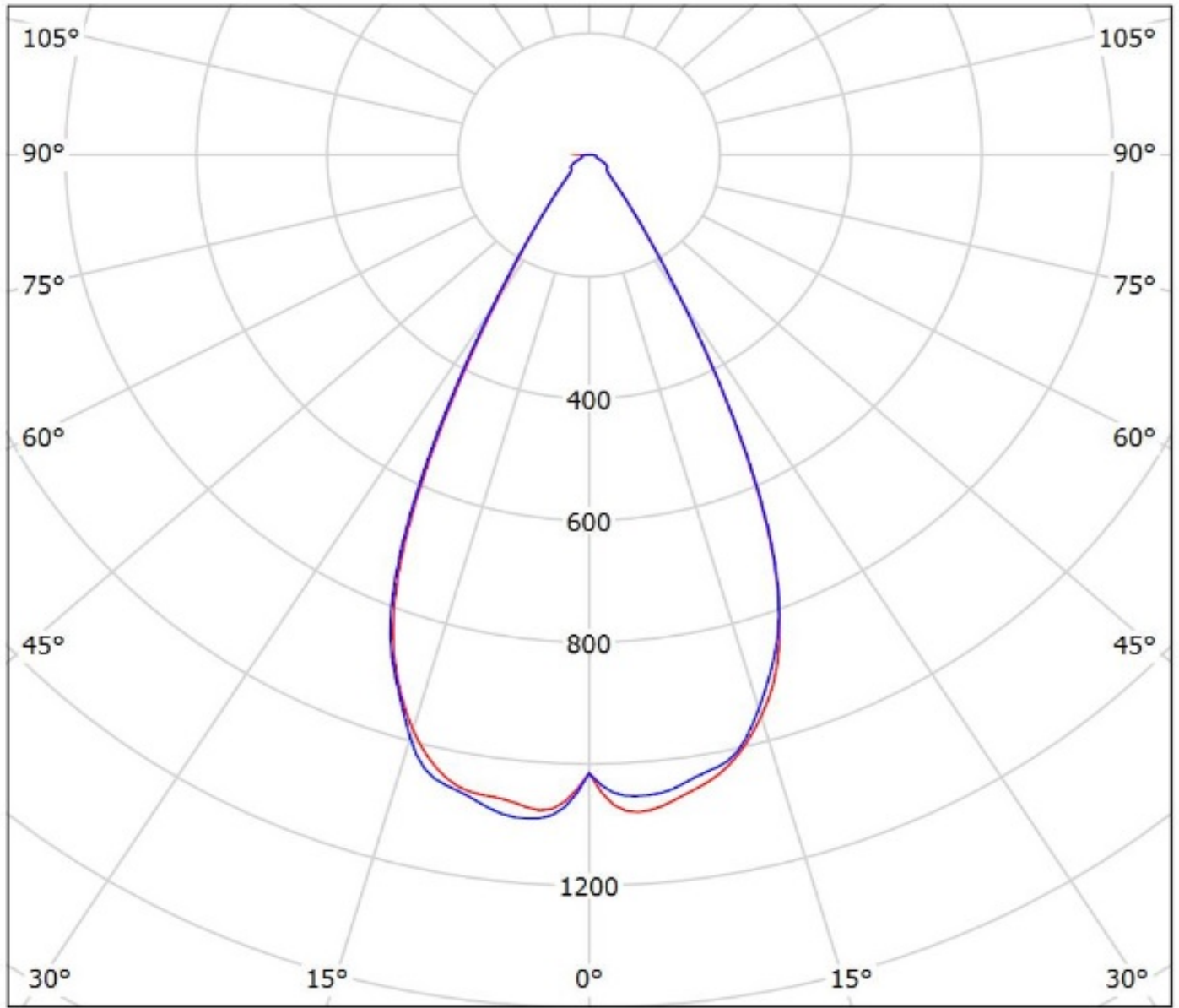

cd/klm

— C0 - C180 — C90 - C270

$\eta = 96\%$

Luminaire: Ledil C12361_HB-2X2-W_(Z8Y22plus)

Lamps: 1 x Seoul_Z8Y22plus_(W6E2G)_513.996lm@250mA_P=2.754W_I=0.250A

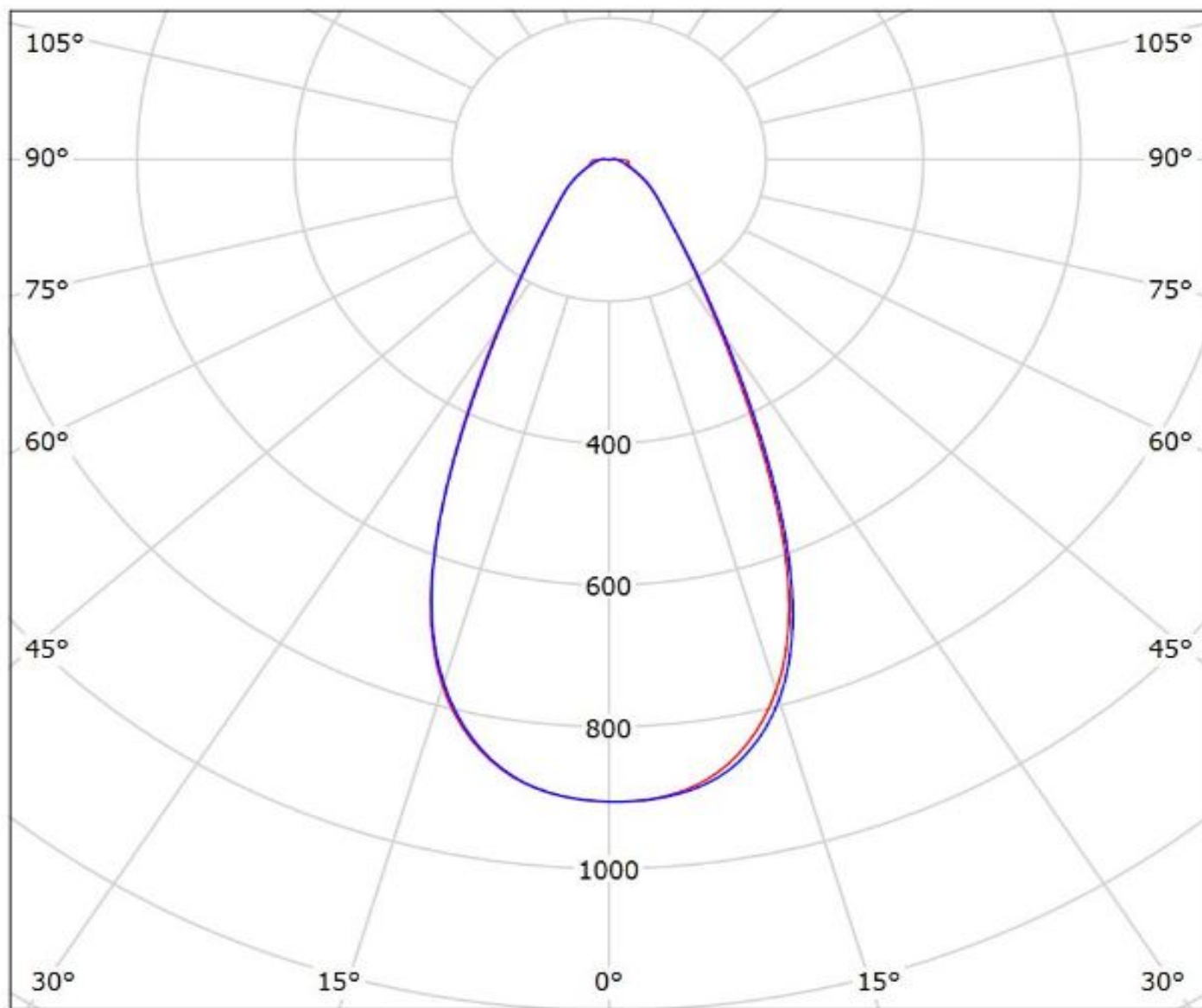

cd/klm

— C0 - C180

— C90 - C270

$\eta = 92\%$

Luminaire: Ledil Oy C12361_HB-2X2-W_(Acrich_MJT_4040)_SIMULATED
Lamps: 1 x Seoul Acrich MJT 4040

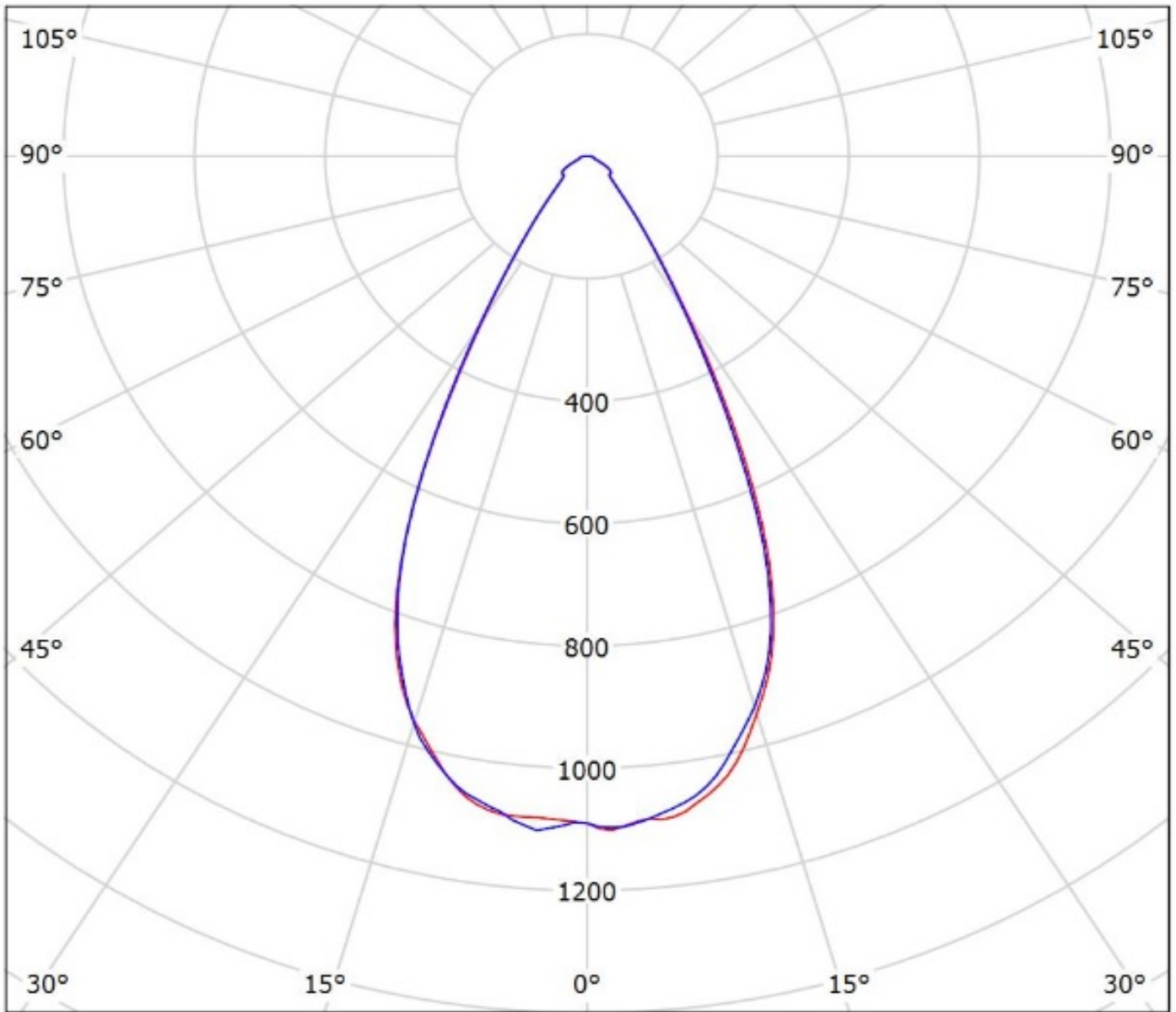

cd/klm

— C0 - C180 — C90 - C270

$\eta = 95\%$

Ledil C12361_HB-2X2-W_(TL1L4) / LDC (Polar)

Luminaire: Ledil C12361_HB-2X2-W_(TL1L4)

Lamps: 1 x Toshiba_TL1L4_2x2_(TL1L4-DW0)_472.639lm@250mA_CCT=6500K_P=2.9W_I=0.25A

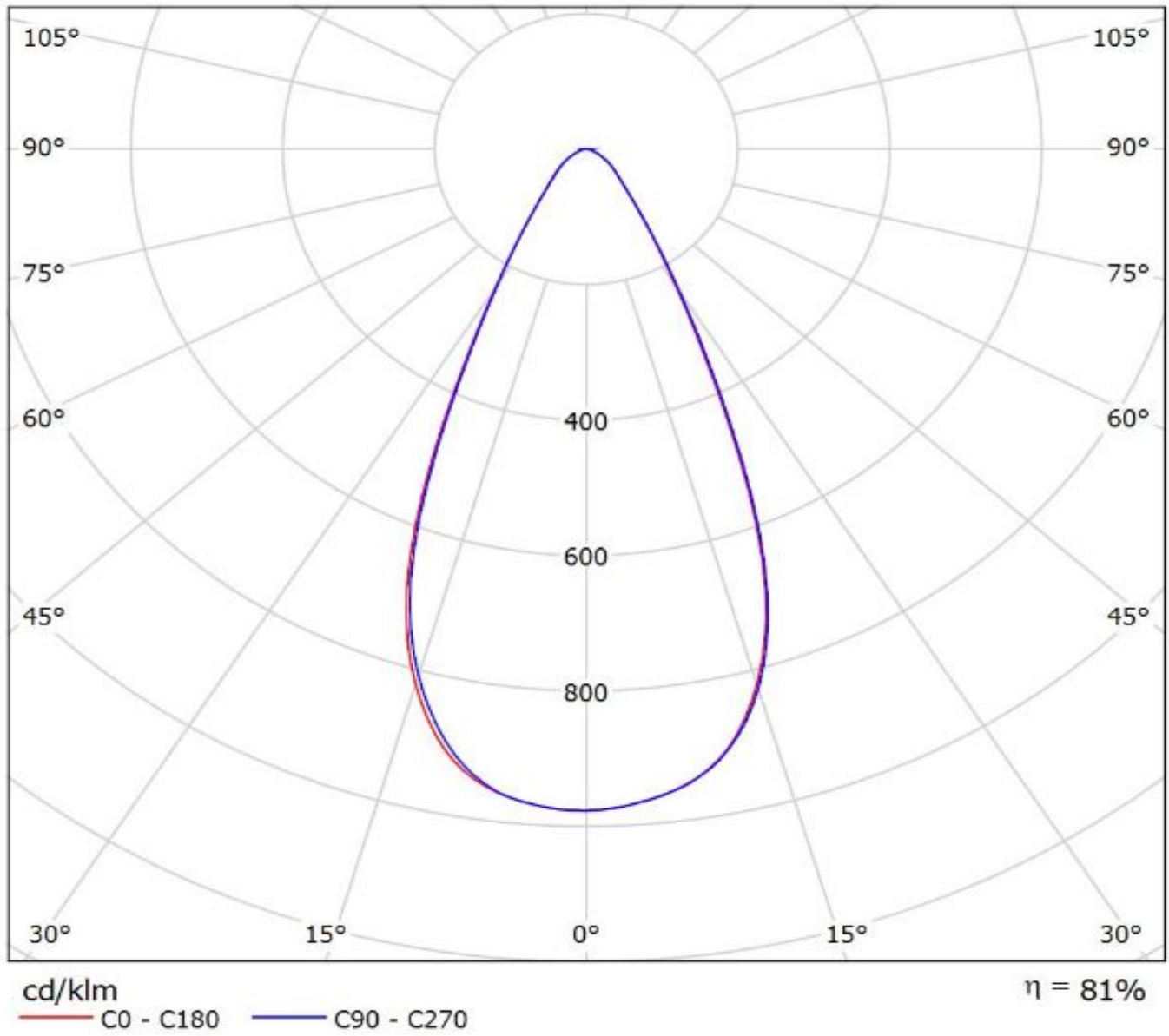

Luminaire: LEDiL Oy C12361_HB-2X2-W_(Tridonic_Module_RLE_G1)
Lamps: 1 x Tridonic_Module_RLE_G1_4576.03lm@700mA_P=32.0681W_I=0.700A

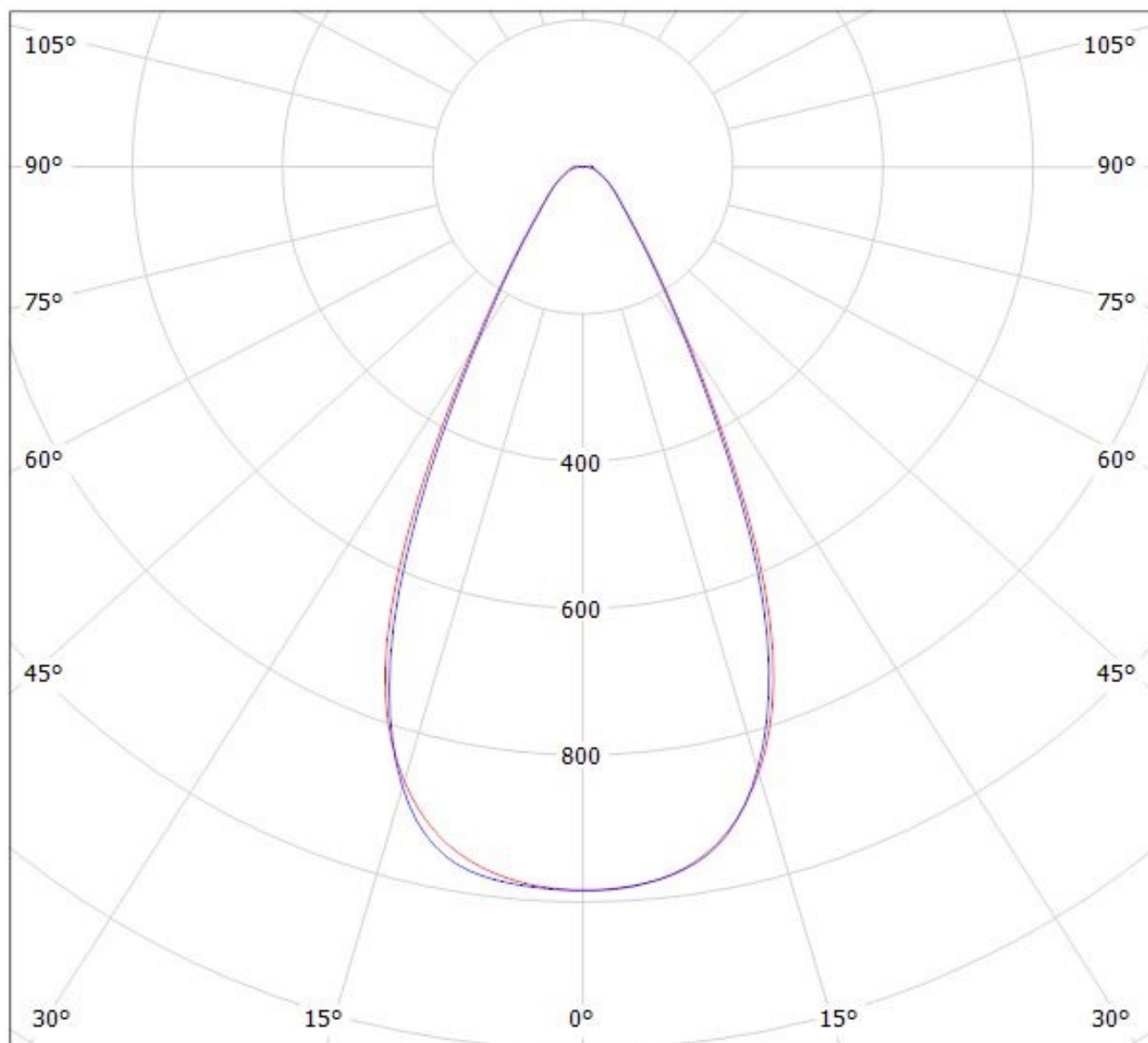

cd/klm

— C0 - C180 — C90 - C270

$\eta = 94\%$

Luminaire: LEDiL Oy C12361_HB-2X2-W_(Tridonic_Module_RLE_G1)
Lamps: 1 x Tridonic_Module_RLE_G1_4576.03lm@700mA_P=32.0681W_I=0.700A

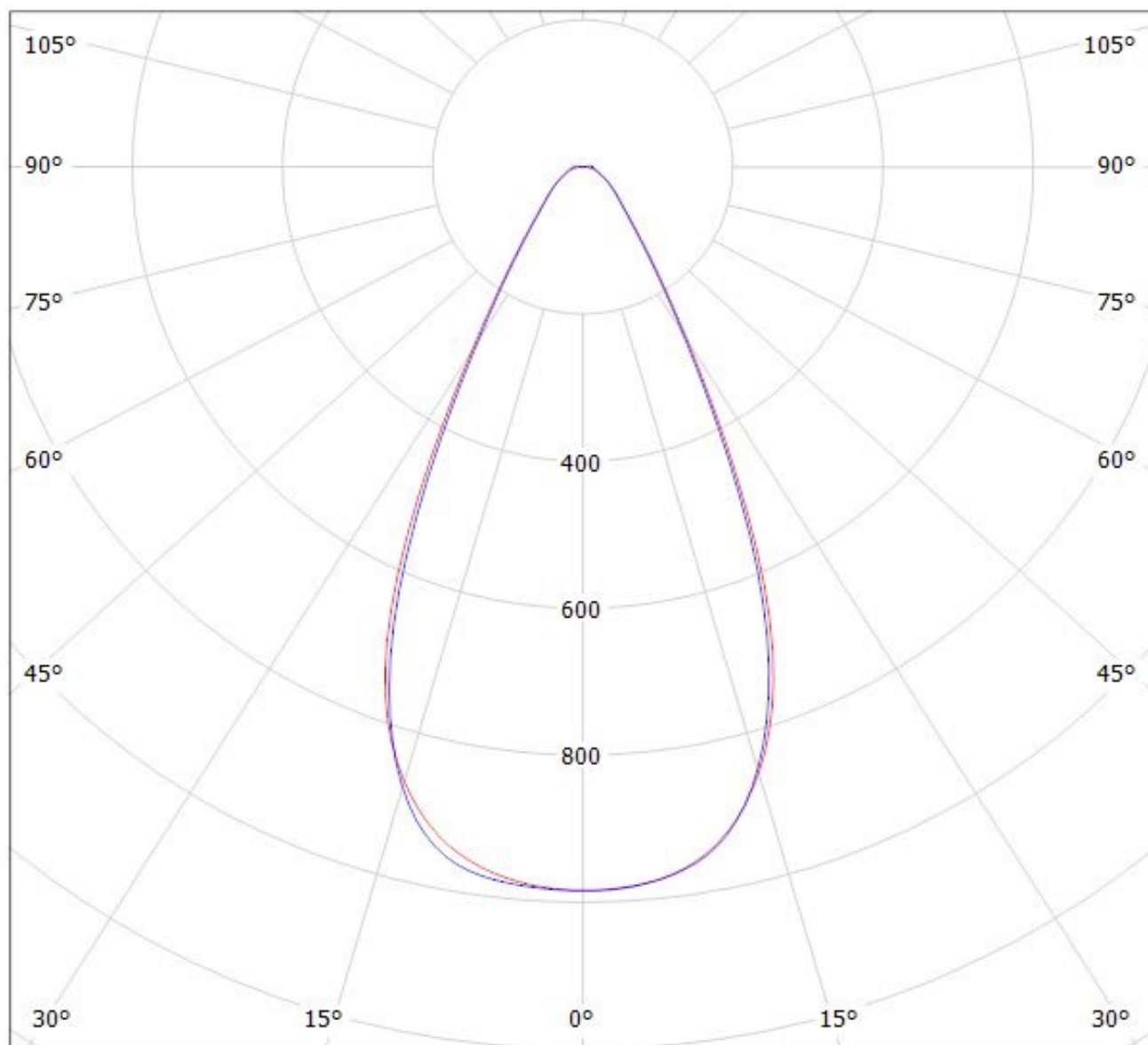

cd/klm

— C0 - C180 — C90 - C270

$\eta = 94\%$

Luminaire: LEDiL Oy C12361_HB-2X2-W_(Tridonic_Module_RLE_G1)
Lamps: 1 x Tridonic_Module_RLE_G1_2288lm@700mA_P=16W_I=0.700A

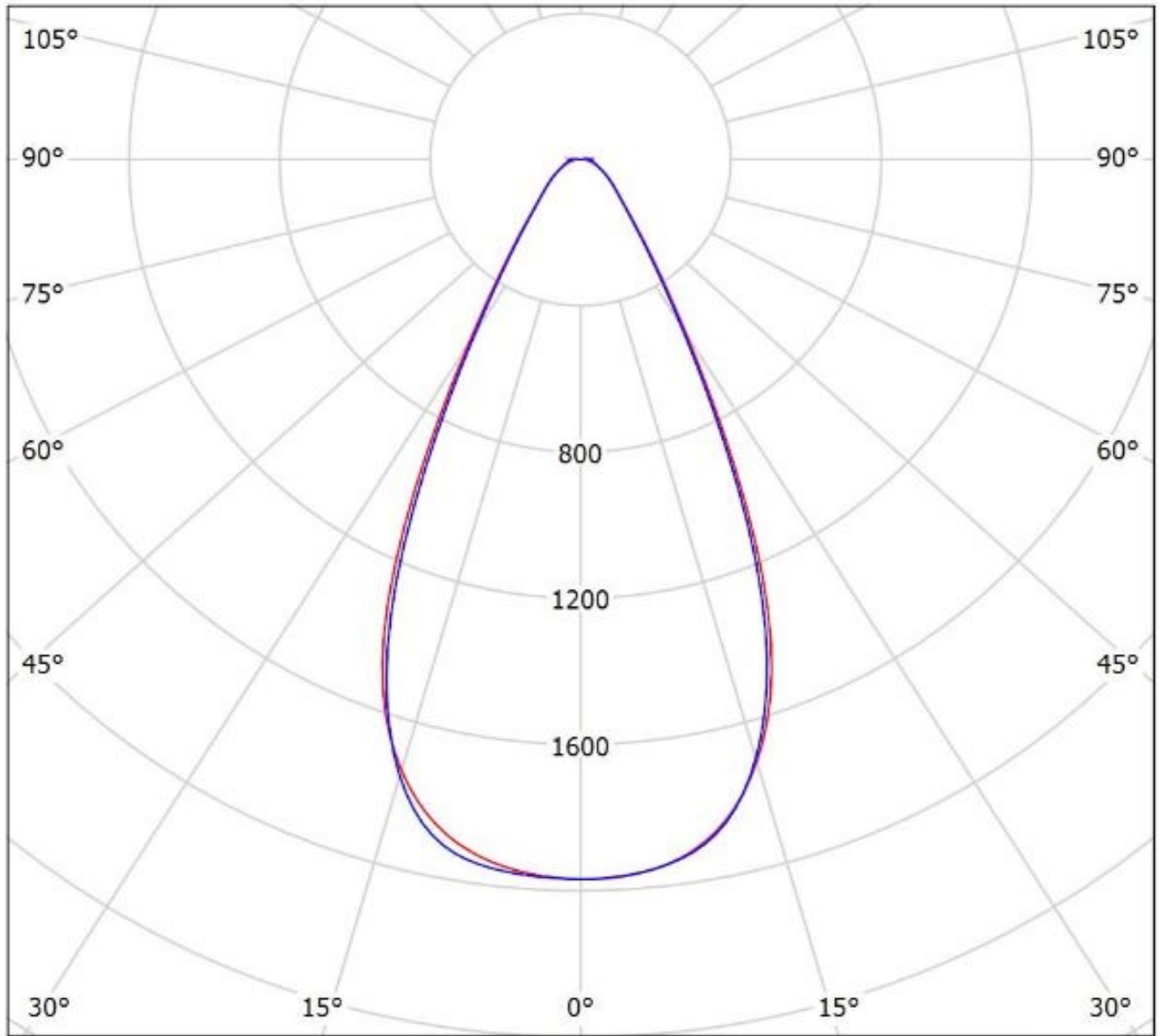

cd/klm

— C0 - C180 — C90 - C270

$\eta = 94\%$

Luminaire: LEDiL Oy C12361_HB-2X2-W_(Tridonic_Module_RLE_G1)
Lamps: 1 x Tridonic_Module_RLE_G1_2288lm@700mA_P=16W_I=0.700A

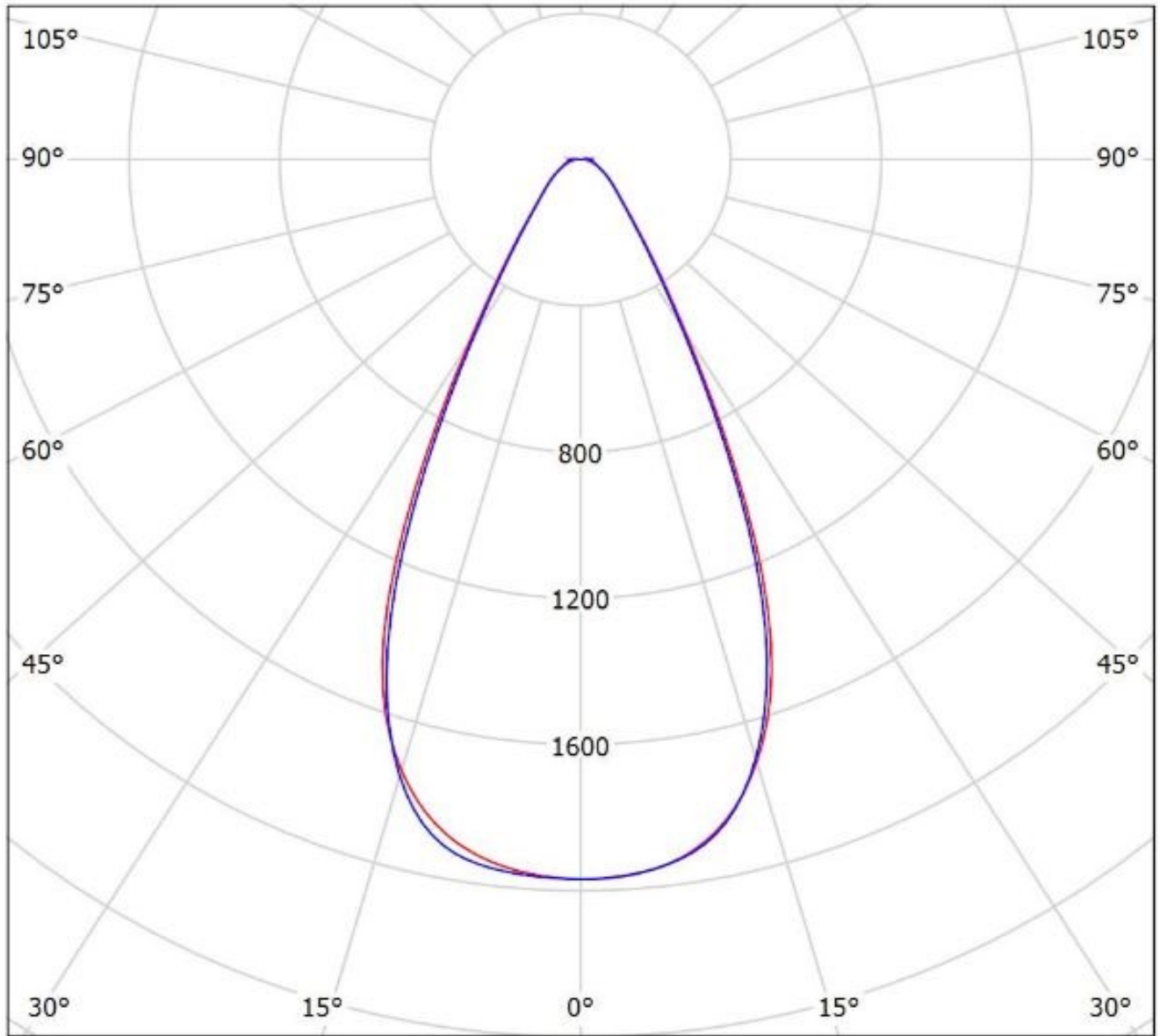

cd/klm

— C0 - C180 — C90 - C270

$\eta = 94\%$

NOTE: The typical divergence will be changed by different color, chip size and chip position tolerance. The typical total divergence is the full angle measured where the luminous intensity is half of the peak value.