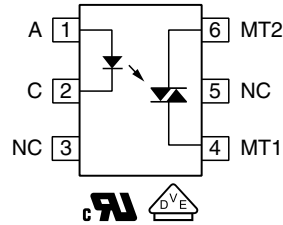
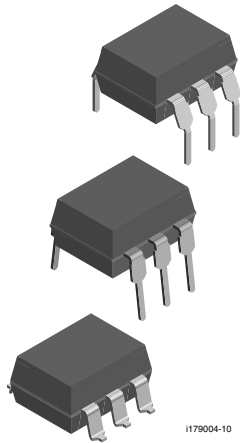


Optocoupler, Phototriac Output, Non-Zero Crossing



FEATURES

- $I_{RMS} = 300 \text{ mA}$
- High static $dV/dt < 10\,000 \text{ V}/\mu\text{s}$
- Electrically insulated between input and output circuit
- Microcomputer compatible - very low trigger current
- Trigger current
 - ($I_{FT} < 1.2 \text{ mA}$) BRT12F
 - ($I_{FT} < 2 \text{ mA}$) BRT11H, BRT12H, BRT13H
 - ($I_{FT} < 3 \text{ mA}$) BRT11M, BRT12M, BRT13M
- Non-zero voltage detectors high input sensitivity
- Compliant to RoHS Directive 2002/95/EC and in accordance to WEEE 2002/96/EC


RoHS
COMPLIANT

DESCRIPTION

The BRT11, BRT12, and BRT13 product family consists of AC optocouplers non-zero voltage detectors consisting of two electrically insulated lateral power ICs which integrate a thyristor system, a photo detector and noise suppression at the output and an IR GaAs diode input.

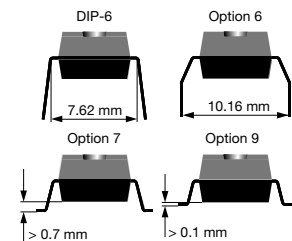
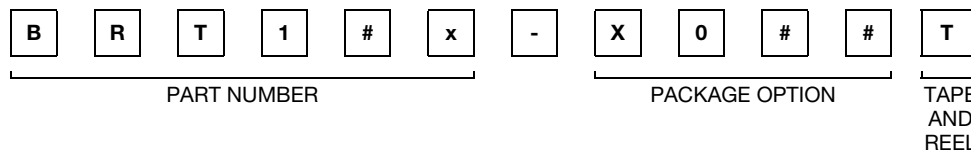
APPLICATIONS

- Industrial controls
- Office equipment
- Consumer appliances

AGENCY APPROVALS

- UL 1577, file no. E52744 system code H
- DIN EN 60747-5-2 (VDE 0844)/DIN EN 60747-5-5 (pending) available with option 1
- CQC

ORDERING INFORMATION



AGENCY CERTIFIED/PACKAGE	$V_{DRM} \text{ (V)}$						
	≤ 400		≤ 600			≤ 800	
	$I_{FT} = 2 \text{ mA}$	$I_{FT} = 3 \text{ mA}$	$I_{FT} = 1.2 \text{ mA}$	$I_{FT} = 2 \text{ mA}$	$I_{FT} = 3 \text{ mA}$	$I_{FT} = 2 \text{ mA}$	$I_{FT} = 3 \text{ mA}$
DIP-6	BRT11H	BRT11M	BRT12F	BRT12H	BRT12M	BRT13H	BRT13M
DIP-6, 400 mil, option 6	-	-	BRT12F-X006	BRT12H-X006	-	BRT13H-X006	-
SMD-6, option 7	-	-	BRT12F-X007T ⁽¹⁾	BRT12H-X007T ⁽¹⁾	-	BRT13H-X007T ⁽¹⁾	-
SMD-6, option 9	-	-	-	BRT12H-X009T	-	BRT13H-X009T	-
UL, VDE	$I_{FT} = 2 \text{ mA}$	$I_{FT} = 3 \text{ mA}$	$I_{FT} = 1.2 \text{ mA}$	$I_{FT} = 2 \text{ mA}$	$I_{FT} = 3 \text{ mA}$	$I_{FT} = 2 \text{ mA}$	$I_{FT} = 3 \text{ mA}$
DIP-6	-	-	-	BRT12H-X001	BRT12M-X001	-	-
DIP-6, option 6	-	-	BRT12F-X016	BRT12H-X016	BRT12M-X016	BRT13H-X016	-
SMD-6, option 7	-	-	-	-	-	BRT13H-X017T ⁽¹⁾	-

Note

⁽¹⁾ Also available in tube, do not put T on the end.



ABSOLUTE MAXIMUM RATINGS ($T_{amb} = 25\text{ }^{\circ}\text{C}$, unless otherwise specified)					
PARAMETER	TEST CONDITION	PART	SYMBOL	VALUE	UNIT
INPUT					
Reverse voltage			V_R	6	V
Forward current			I_F	20	mA
Surge forward current			I_{FSM}	1.5	A
Power dissipation	$t \leq 10\text{ }\mu\text{s}$		P_{diss}	30	mW
OUTPUT					
Repetitive peak off-state voltage		BRT11	V_{DRM}	400	V
		BRT12	V_{DRM}	600	V
		BRT13	V_{DRM}	800	V
RMS on-state current			I_{TRMS}	300	mA
Single cycle surge current	50 Hz		I_{TSM}	3	A
Power dissipation			P_{diss}	600	mW
COUPLER					
Maximum power dissipation			P_{tot}	630	mW
Isolation test voltage (between emitter and detector, climate per DIN 500414, part 2, Nov. 74) ⁽¹⁾			V_{ISO}	5300	V_{RMS}
Reference voltage in accordance with VDE 0110 b			V_{ref}	500	V_{RMS}
Reference voltage in accordance with VDE 0110 b (insulation group C)			V_{ref}	600	V_{DC}
Creepage distance				≥ 7.2	mm
Clearance distance				≥ 7.2	mm
Comparative tracking index per DIN IEC 112/VDE 0303 part 1	group IIIa according to DIN VDE 0109		CTI	≥ 175	
Isolation resistance	$V_{IO} = 500\text{ V}$, $T_{amb} = 25\text{ }^{\circ}\text{C}$		R_{IO}	$\geq 10^{12}$	Ω
	$V_{IO} = 500\text{ V}$, $T_{amb} = 100\text{ }^{\circ}\text{C}$		R_{IO}	$\geq 10^{11}$	Ω
Storage temperature range			T_{stg}	- 40 to + 150	$^{\circ}\text{C}$
Ambient temperature range			T_{amb}	- 40 to + 100	$^{\circ}\text{C}$

Notes

- Stresses in excess of the absolute maximum ratings can cause permanent damage to the device. Functional operation of the device is not implied at these or any other conditions in excess of those given in the operational sections of this document. Exposure to absolute maximum ratings for extended periods of the time can adversely affect reliability.

⁽¹⁾ Test AC voltage in accordance with DIN 57883, June 1980.

ELECTRICAL CHARACTERISTICS ($T_{amb} = 25\text{ }^{\circ}\text{C}$, unless otherwise specified)							
PARAMETER	TEST CONDITION	PART	SYMBOL	MIN.	TYP.	MAX.	UNIT
INPUT							
Forward voltage	$I_F = 10\text{ mA}$		V_F		1.1	1.35	V
Reverse current	$V_R = 6\text{ V}$		I_R			10	μA
Thermal resistance, junction to ambient ⁽¹⁾			R_{thJA}			750	$^{\circ}\text{C/W}$
OUTPUT							
Peak off-state voltage	$I_{D(RMS)} = 100\text{ }\mu\text{A}$	BRT11	V_{DM}		400		μA
		BRT12			600		μA
		BRT13			800		μA
Off-state current	$T_C = 80\text{ }^{\circ}\text{C}$, V_{DRM}		I_D		0.5	100	μA
On-state voltage	$I_T = 300\text{ mA}$		V_T			2.3	V
Pulse current	$t_p \leq 5\text{ }\mu\text{s}$, $f = 100\text{ Hz}$, $di_{tp}/dt \leq 8\text{ A}/\mu\text{s}$		I_{tp}			2	A
Critical rate of rise of off-state voltage	$V_D = 0.67\text{ }V_{DRM}$, $T_j = 25\text{ }^{\circ}\text{C}$		dV/dt_{cr}	10			$\text{kV}/\mu\text{s}$
	$V_D = 0.67\text{ }V_{DRM}$, $T_j = 80\text{ }^{\circ}\text{C}$		dV/dt_{cr}	5			$\text{kV}/\mu\text{s}$
Critical rate of rise of voltage at current commutation	$V_D = 0.67\text{ }V_{DRM}$, $T_j = 25\text{ }^{\circ}\text{C}$, $di/dt_{crq} \leq 15\text{ A/ms}$		dV/dt_{crq}	10			$\text{kV}/\mu\text{s}$
	$V_D = 0.67\text{ }V_{DRM}$, $T_j = 80\text{ }^{\circ}\text{C}$, $di/dt_{crq} \leq 15\text{ A/ms}$		dV/dt_{crq}	5			$\text{kV}/\mu\text{s}$
Critical rate of rise of on-state at current			di/dt_{cr}	8			$\text{A}/\mu\text{s}$
Holding current	$V_D = 10\text{ V}$		I_H		80	500	μA
Thermal resistance, junction to ambient			R_{thJA}			125	$^{\circ}\text{C/W}$
COUPLER							
Trigger current	$V_D = 10\text{ V}$, F - versions		I_{FT}			1.2	mA
	$V_D = 10\text{ V}$, H - versions		I_{FT}	0.4		2	mA
	$V_D = 10\text{ V}$, M - versions		I_{FT}	0.8		3	mA
Trigger current temperature gradient			$\Delta I_{FT}/\Delta T_j$		7	14	$\mu\text{A}/^{\circ}\text{C}$
Capacitance (input to output)	$f = 1\text{ MHz}$, $V_R = 0\text{ V}$		C_{IO}			2	pF

Notes

- Minimum and maximum values are testing requirements. Typical values are characteristics of the device and are the result of engineering evaluation. Typical values are for information only and are not part of the testing requirements.
- (1) Static air, SITAC soldered in PCB or base plate.

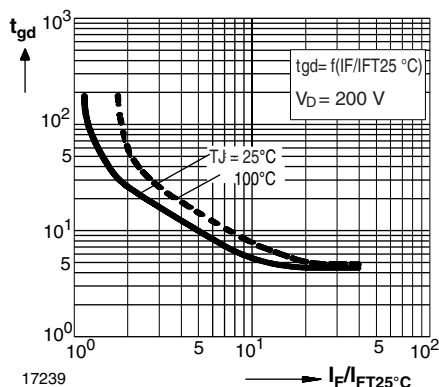
TYPICAL CHARACTERISTICS ($T_{amb} = 25\text{ }^{\circ}\text{C}$, unless otherwise specified)


Fig. 1 - Typical Trigger Delay Time

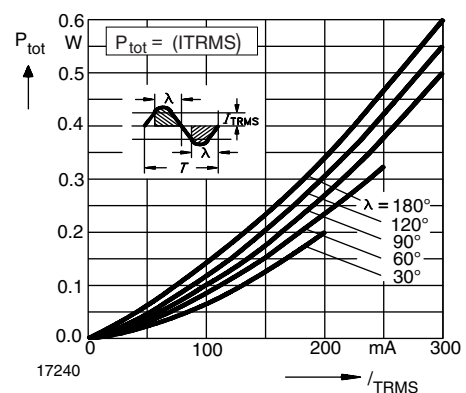


Fig. 2 - Power Dissipation 60 Hz to 60 Hz Line Operation

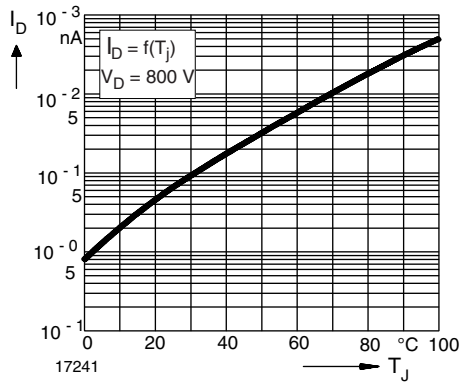


Fig. 3 - Typical Off-State Current

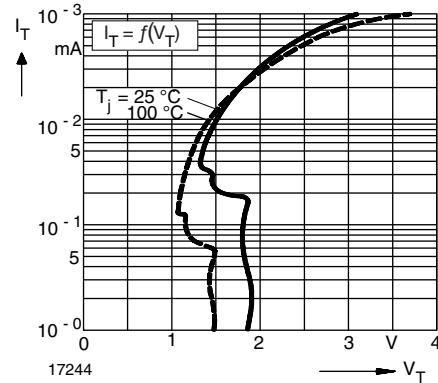


Fig. 6 - Typical Output Characteristics

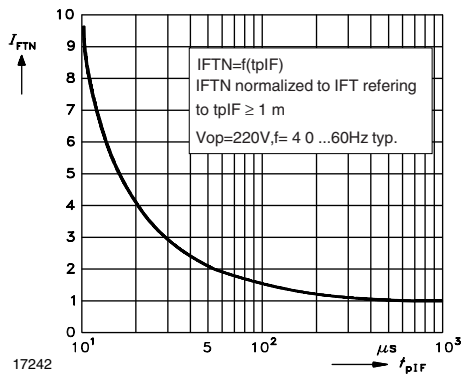


Fig. 4 - Pulse Trigger Current

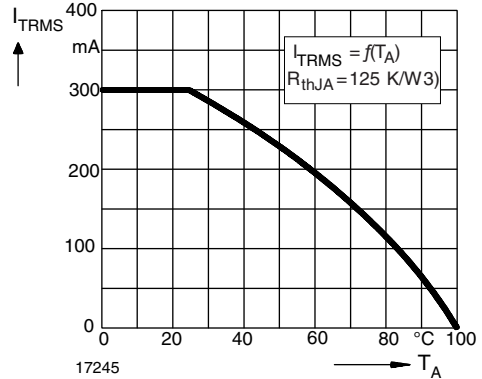


Fig. 7 - Current Reduction

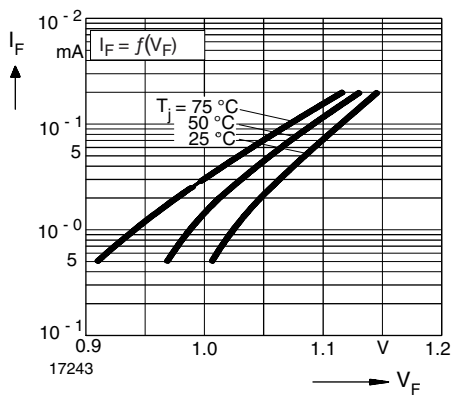


Fig. 5 - Typical Input Characteristics

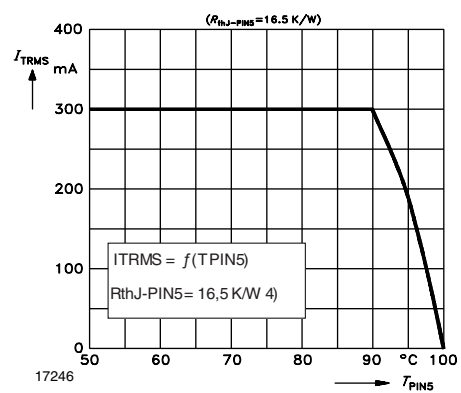
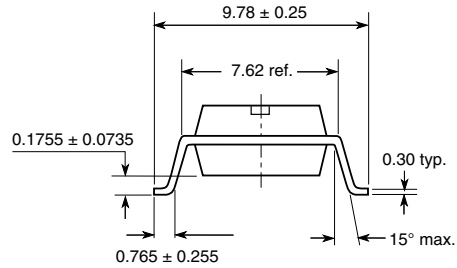
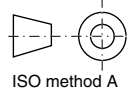
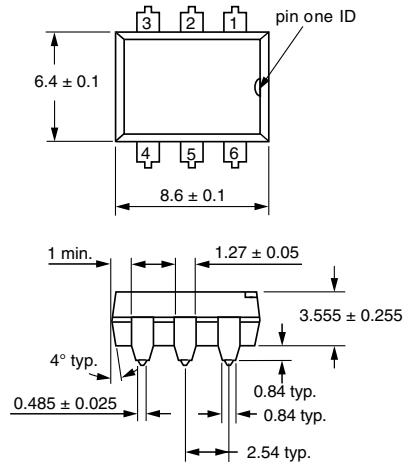


Fig. 8 - Current Reduction

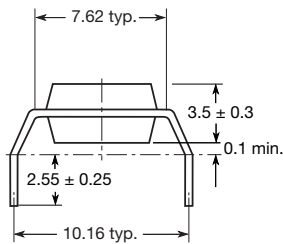


PACKAGE DIMENSIONS in millimeters

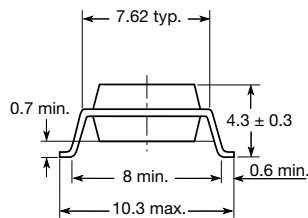


17222

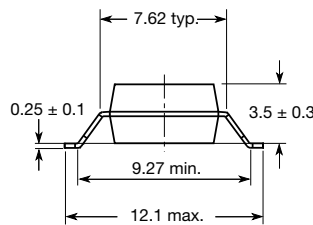
Option 6



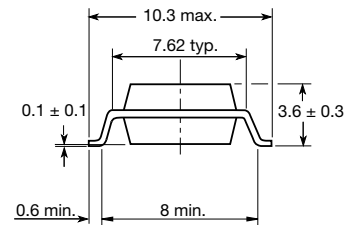
Option 7



Option 8

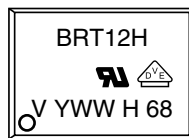


Option 9



20802-40

PACKAGE MARKING (example)



Notes

- Only options 1, and 7 are reflected in the package marking.
- The VDE logo is only marked on option 1 parts.
- Tape and reel suffix (T) is not part of the package marking.



Disclaimer

ALL PRODUCT, PRODUCT SPECIFICATIONS AND DATA ARE SUBJECT TO CHANGE WITHOUT NOTICE TO IMPROVE RELIABILITY, FUNCTION OR DESIGN OR OTHERWISE.

Vishay Intertechnology, Inc., its affiliates, agents, and employees, and all persons acting on its or their behalf (collectively, "Vishay"), disclaim any and all liability for any errors, inaccuracies or incompleteness contained in any datasheet or in any other disclosure relating to any product.

Vishay makes no warranty, representation or guarantee regarding the suitability of the products for any particular purpose or the continuing production of any product. To the maximum extent permitted by applicable law, Vishay disclaims (i) any and all liability arising out of the application or use of any product, (ii) any and all liability, including without limitation special, consequential or incidental damages, and (iii) any and all implied warranties, including warranties of fitness for particular purpose, non-infringement and merchantability.

Statements regarding the suitability of products for certain types of applications are based on Vishay's knowledge of typical requirements that are often placed on Vishay products in generic applications. Such statements are not binding statements about the suitability of products for a particular application. It is the customer's responsibility to validate that a particular product with the properties described in the product specification is suitable for use in a particular application. Parameters provided in datasheets and / or specifications may vary in different applications and performance may vary over time. All operating parameters, including typical parameters, must be validated for each customer application by the customer's technical experts. Product specifications do not expand or otherwise modify Vishay's terms and conditions of purchase, including but not limited to the warranty expressed therein.

Except as expressly indicated in writing, Vishay products are not designed for use in medical, life-saving, or life-sustaining applications or for any other application in which the failure of the Vishay product could result in personal injury or death. Customers using or selling Vishay products not expressly indicated for use in such applications do so at their own risk. Please contact authorized Vishay personnel to obtain written terms and conditions regarding products designed for such applications.

No license, express or implied, by estoppel or otherwise, to any intellectual property rights is granted by this document or by any conduct of Vishay. Product names and markings noted herein may be trademarks of their respective owners.