

LDO Regulator - Fast Transient Response Low Voltage

1 A

NCP186

The NCP186x series are CMOS LDO regulators featuring 1 A output current. The input voltage is as low as 1.8 V and the output voltage can be set from 0.8 V.

Features

- Operating Input Voltage Range: 1.8 V to 5.5 V
- Output Voltage Range: 0.8 to 3.9 V
- Fixed or Adjustable Output Voltage Applications
- Quiescent Current typ. 90 μ A
- Low Dropout: 100 mV typ. at 1 A, $V_{OUT} = 3.0$ V
- High Output Voltage Accuracy $\pm 1\%$
- Stable with Small 1 μ F Ceramic Capacitors
- Over-current Protection
- Built-in Soft Start Circuit to Suppress Inrush Current
- Thermal Shutdown Protection: 165°C
- With (NCP186A) and Without (NCP186B) Output Discharge Function
- Available in XDFN8 1.2x1.6mm & DFN12 4x4mm Packages
- These Devices are Pb-Free, Halogen Free/BFR Free and are RoHS Compliant

Typical Applications

- Battery Powered Equipment
- Portable Communication Equipment
- Cameras, Image Sensors and Camcorders

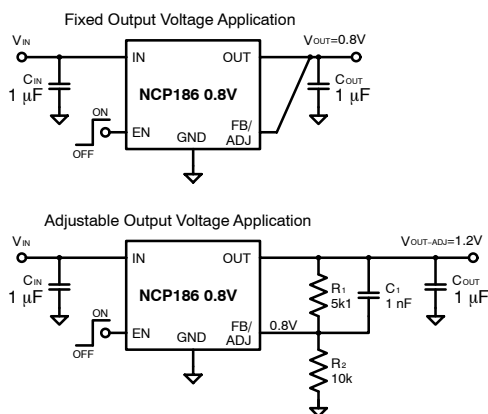

$$V_{OUT-ADJ} = V_{OUT-NOM} \cdot \left(1 + \frac{R_1}{R_2} \right) = 0.8 \cdot \left(1 + \frac{R_1}{R_2} \right)$$

Set I_{R1} , I_{R2} in range from 10 μ A to 100 μ A

Figure 1. Typical Application Schematic

MARKING DIAGRAMS



XDFN8
MX SUFFIX
CASE 711AS

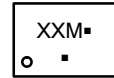

XX = Specific Device Code
M = Date Code
▪ = Pb-Free Package

(Note: Microdot may be in either location)

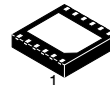

DFN12
MU SUFFIX
CASE 506CE

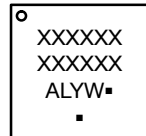

XXXXXX = Specific Device Code
A = Assembly Location
L = Wafer Lot
Y = Year
W = Work Week
▪ = Pb-Free Package

(Note: Microdot may be in either location)

PIN CONNECTIONS

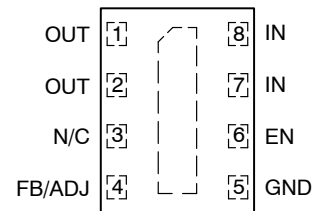

(Top View)

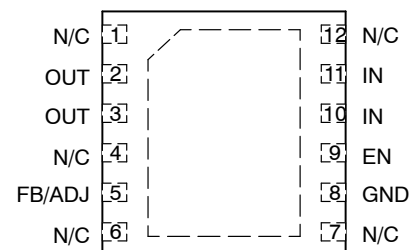

(Top View)

ORDERING INFORMATION

See detailed ordering and shipping information on page 12 of this data sheet.

NCP186

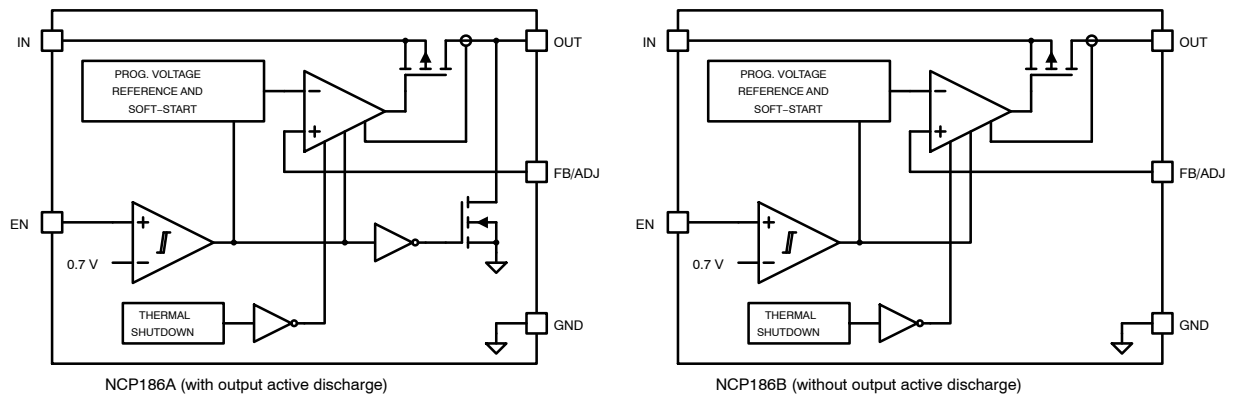

Figure 2. Internal Block Diagram

Table 1. PIN FUNCTION DESCRIPTION

Pin No. XDFN8	Pin No. DFN12	Pin Name	Description
1, 2	2, 3	OUT	LDO output pin
3	1,4,6,7,12	N/C	Tune the space here, this line is not horizontally aligned with others. Not internally connected. This pin can be tied to the ground plane to improve thermal dissipation.
4	5	FB/ADJ	Feedback / adjustable input pin (connect this pin directly to the OUT pin or to the resistor divider)
5	8	GND	Ground pin
6	9	EN	Chip enable input pin (active "H")
7, 8	10, 11	IN	Power supply input pin
EPAD	EPAD	EPAD	It's recommended to connect the EPAD to GND, but leaving it open is also acceptable

Table 2. ABSOLUTE MAXIMUM RATINGS

Rating	Symbol	Value	Unit
Input Voltage (Note 1)	IN	-0.3 to 6.0	V
Output Voltage	OUT	-0.3 to $V_{IN} + 0.3$	V
Chip Enable Input	EN	-0.3 to 6.0	V
Output Current	I_{OUT}	Internally Limited	mA
Maximum Junction Temperature	$T_{J(MAX)}$	150	°C
Storage Temperature	T_{STG}	-55 to 150	°C
ESD Capability, Human Body Model (Note 2)	ESD_{HBM}	2000	V
ESD Capability, Charged Device Model (Note 2)	ESD_{CDM}	1000	V

Stresses exceeding those listed in the Maximum Ratings table may damage the device. If any of these limits are exceeded, device functionality should not be assumed, damage may occur and reliability may be affected.

1. Refer to ELECTRICAL CHARACTERISTICS and APPLICATION INFORMATION for Safe Operating Area.
2. This device series incorporates ESD protection and is tested by the following methods:
 ESD Human Body Model tested per AEC-Q100-002 (EIA/JESD22-A114)
 ESD Charged Device Model tested per JS-002-2014
 Latchup Current Maximum Rating tested per JEDEC standard: JESD78

Table 3. THERMAL CHARACTERISTICS

Rating	Symbol	Value	Unit
Thermal Resistance, Junction-to-Air, XDFN8 1.2 mm x 1.6 mm (Note 3)	$R_{\theta JA}$	111	°C/W
Thermal Resistance, Junction-to-Air, DFN12 4 mm x 4 mm (Note 3)	$R_{\theta JA}$	44	°C/W

3. Measured according to JEDEC board specification. Detailed description of the board can be found in JESD51-7.

NCP186

Table 4. ELECTRICAL CHARACTERISTICS

$V_{IN} = V_{OUT_NOM} + 0.5\text{ V}$ or $V_{IN} = 1.8\text{ V}$ whichever is greater; $I_{OUT} = 1\text{ mA}$; $C_{IN} = C_{OUT} = 1.0\text{ }\mu\text{F}$ (effective capacitance) (Note 4); $V_{EN} = 1.2\text{ V}$; $T_J = 25^\circ\text{C}$ (Note 5); FB/ADJ pin connected to OUT; unless otherwise noted. The specifications in bold are guaranteed at $-40^\circ\text{C} \leq T_J \leq 125^\circ\text{C}$.

Parameter	Test Conditions	Symbol	Min	Typ	Max	Unit	
Operating Input Voltage		V_{IN}	1.8		5.5	V	
Output Voltage Accuracy	$V_{OUT_NOM} + 0.5\text{ V} \leq V_{IN} \leq 5.5\text{ V}$, $V_{IN} \geq 1.8\text{ V}$ $I_{OUT} = 0\text{ to }1\text{ A}$, $-40^\circ\text{C} \leq T_J \leq 85^\circ\text{C}$	V_{OUT_NOM}	-1.0		1.0	%	
	$V_{OUT_NOM} + 0.5\text{ V} \leq V_{IN} \leq 5.5\text{ V}$, $V_{IN} \geq 1.8\text{ V}$ $I_{OUT} = 0\text{ to }1\text{ A}$, $-40^\circ\text{C} \leq T_J \leq 125^\circ\text{C}$ $V_{OUT_NOM} \geq 1.2\text{ V}$		-2.0		1.0		
	$V_{OUT_NOM} + 0.5\text{ V} \leq V_{IN} \leq 5.5\text{ V}$, $V_{IN} \geq 1.8\text{ V}$ $I_{OUT} = 0\text{ to }1\text{ A}$, $-40^\circ\text{C} \leq T_J \leq 125^\circ\text{C}$ $V_{OUT_NOM} < 1.2\text{ V}$		-2.5		1.0		
Load Regulation	$I_{OUT} = 1\text{ mA to }1000\text{ mA}$	LoadReg		0.7	5.0	mV	
Line Regulation	$V_{IN} = V_{OUT_NOM} + 0.5\text{ V to }5.0\text{ V}$, $V_{IN} \geq 1.8\text{ V}$	LineReg		0.002	0.1	%/V	
Dropout Voltage	XDFN8 1.2x1.6 $I_{OUT} = 1\text{ A}$ When V_{OUT} falls to $V_{OUT_NOM} - 100\text{ mV}$	V_{DO}			405	585	mV
					180	295	
					175	285	
					170	280	
					120	190	
					110	170	
					102	163	
					100	160	
					95	145	
					92	135	
		86	130				
Quiescent Current	$I_{OUT} = 0\text{ mA}$	I_Q		90	140	μA	
Standby Current	$V_{EN} = 0\text{ V}$	I_{STBY}		0.1	1.5	μA	
FB/ADJ Pin Input Current		$I_{FB/ADJ}$		10		nA	
Output Current Limit	$V_{OUT} = 90\%$ of V_{OUT_NOM}	I_{OCL}	1100	1400		mA	
Output Short Circuit Current	$V_{OUT} = 0\text{ V}$	I_{OSC}	1100	1400		mA	
Enable Input Current		I_{EN}		0.15	0.6	μA	
Enable Threshold Voltage	EN Input Voltage "H"	V_{ENH}	1.0			V	
	EN Input Voltage "L"	V_{ENL}			0.4		
Power Supply Rejection Ratio	$V_{IN} = V_{OUT_NOM} + 1.0\text{ V}$, Ripple 0.2 Vp-p, $I_{OUT} = 30\text{ mA}$, $f = 1\text{ kHz}$	PSRR		75		dB	
Output Noise	$f = 10\text{ Hz to }100\text{ kHz}$	V_N		48		μV_{RMS}	
Output Discharge Resistance (NCP186A option only)	$V_{IN} = 5.5\text{ V}$, $V_{EN} = 0\text{ V}$, $V_{OUT} = 1.8\text{ V}$	R_{AD}		34		Ω	
Thermal Shutdown Temperature	Temperature rising from $T_J = +25^\circ\text{C}$	T_{SD}		165		$^\circ\text{C}$	
Thermal Shutdown Hysteresis	Temperature falling from T_{SD}	T_{SDH}		20		$^\circ\text{C}$	

Product parametric performance is indicated in the Electrical Characteristics for the listed test conditions, unless otherwise noted. Product performance may not be indicated by the Electrical Characteristics if operated under different conditions.

4. Effective capacitance, including the effect of DC bias, tolerance and temperature. See the Application Information section for more information.

5. Performance guaranteed over the indicated operating temperature range by design and/or characterization. Production tested at $T_A = 25^\circ\text{C}$. Low duty cycle pulse techniques are used during the testing to maintain the junction temperature as close to ambient as possible.

NCP186

TYPICAL CHARACTERISTICS

$V_{IN} = V_{OUT-NOM} + 0.5 \text{ V}$ OR $V_{IN} = 1.8 \text{ V}$, WHICHEVER IS GREATER, $V_{EN} = 1.2 \text{ V}$, $I_{OUT} = 1 \text{ mA}$, $C_{IN} = C_{OUT} = 1.0 \text{ MF}$, $T_J = 25^\circ\text{C}$.

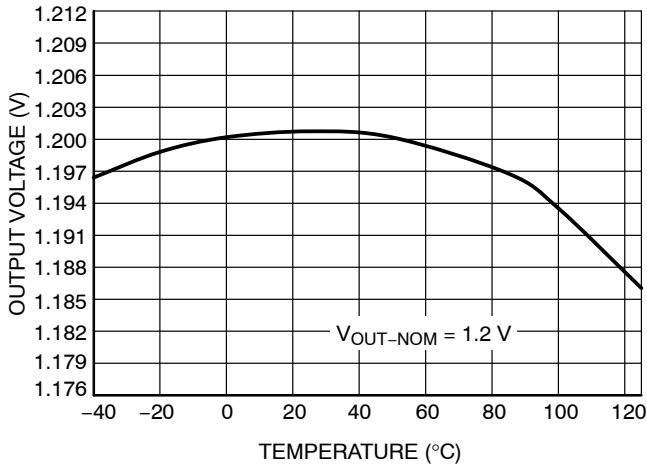

Figure 3. Output Voltage vs. Temperature

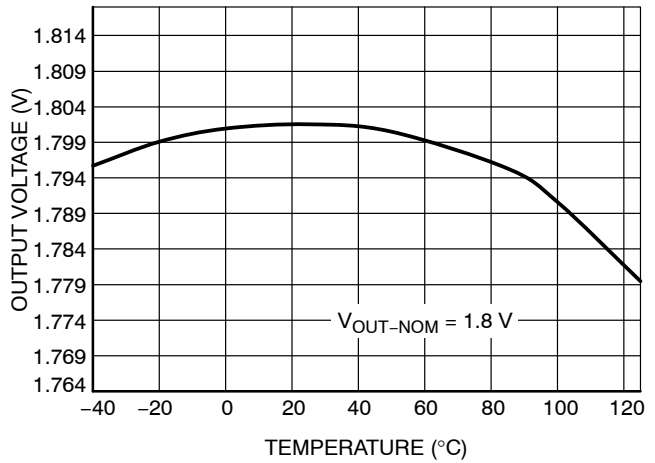

Figure 4. Output Voltage vs. Temperature

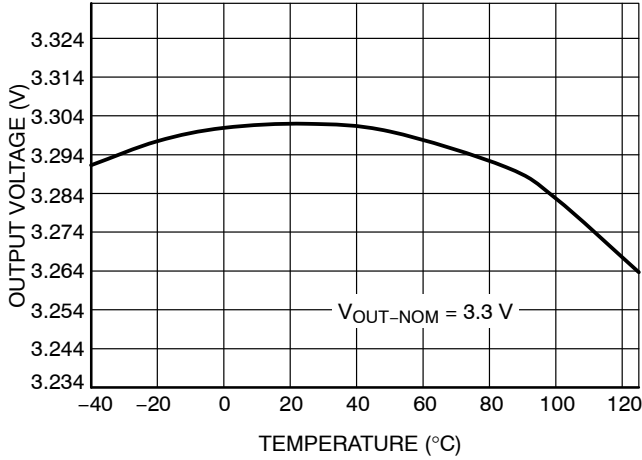

Figure 5. Output Voltage vs. Temperature

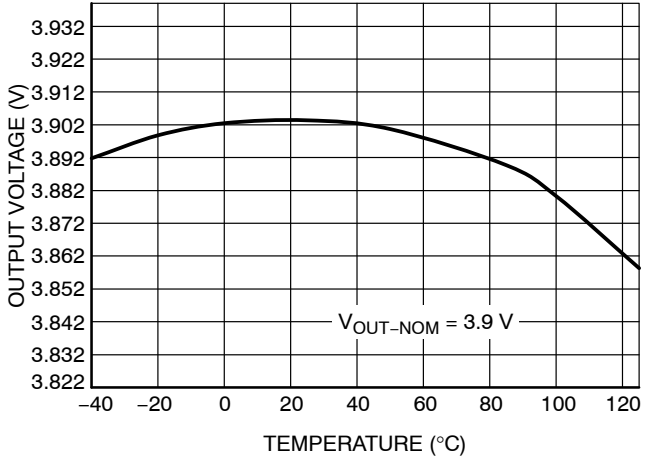

Figure 6. Output Voltage vs. Temperature

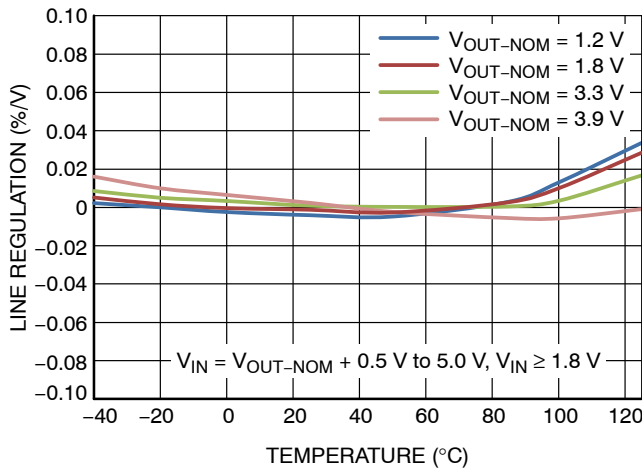

Figure 7. Line Regulation vs. Temperature

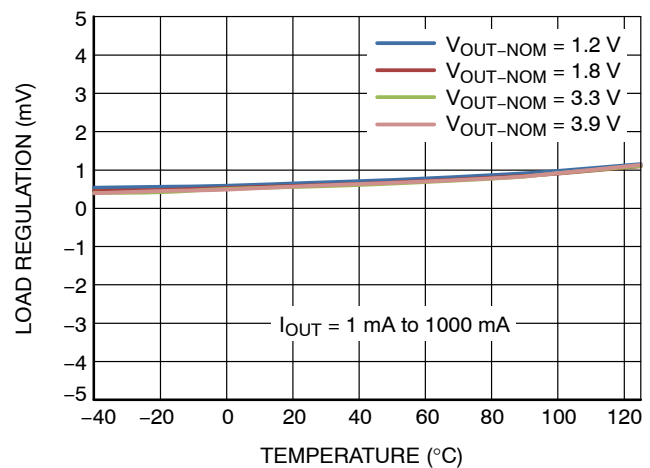

Figure 8. Load Regulation vs. Temperature

TYPICAL CHARACTERISTICS

$V_{IN} = V_{OUT-NOM} + 0.5\text{ V}$ OR $V_{IN} = 1.8\text{ V}$, WHICHEVER IS GREATER, $V_{EN} = 1.2\text{ V}$, $I_{OUT} = 1\text{ MA}$, $C_{IN} = C_{OUT} = 1.0\text{ MF}$, $T_J = 25^\circ\text{C}$.

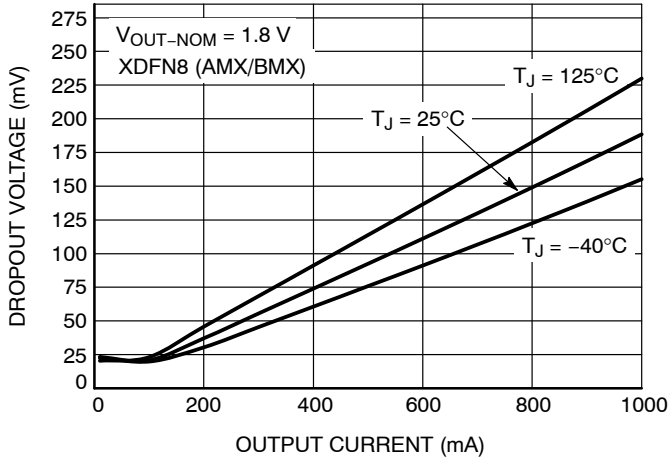

Figure 9. Dropout Voltage vs. Output Current

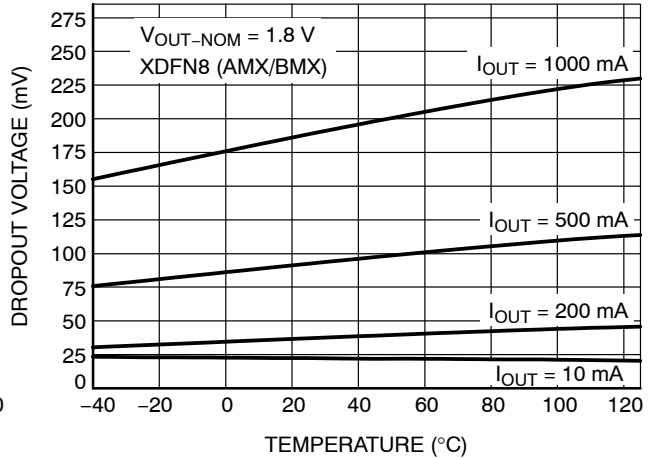

Figure 10. Dropout Voltage vs. Temperature

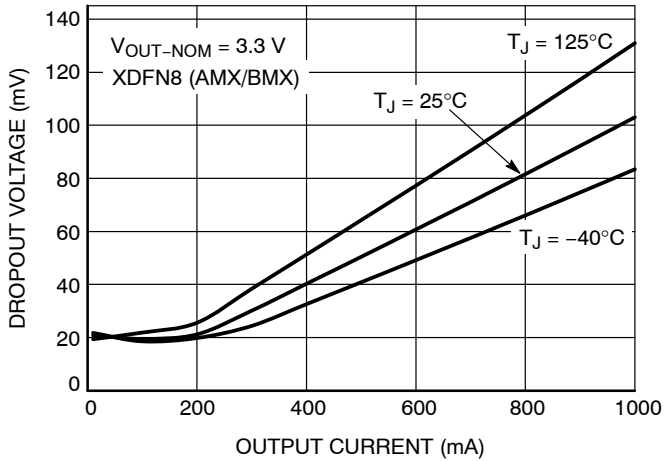

Figure 11. Dropout Voltage vs. Output Current

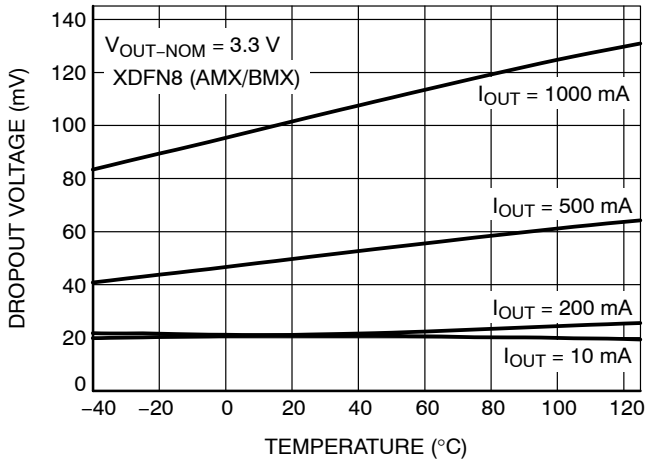

Figure 12. Dropout Voltage vs. Temperature

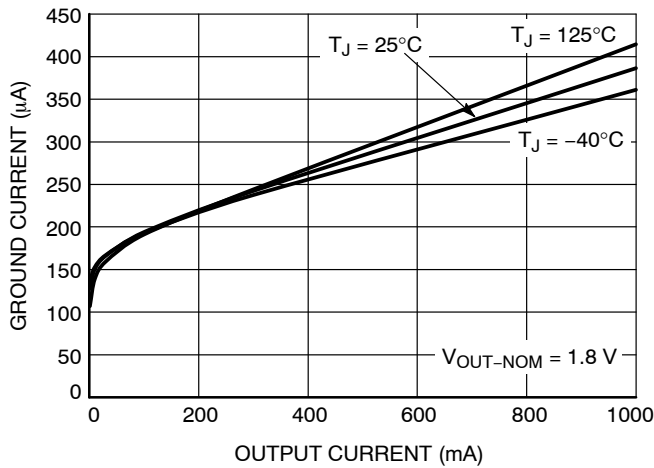

Figure 13. Ground Current vs. Output Current

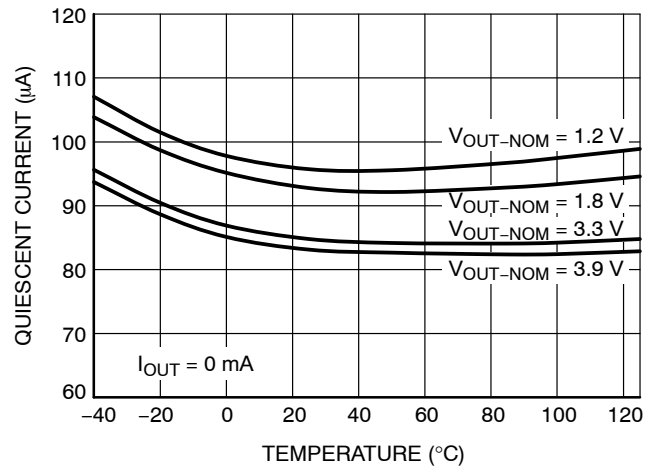

Figure 14. Quiescent Current vs. Temperature

TYPICAL CHARACTERISTICS

$V_{IN} = V_{OUT-NOM} + 0.5\text{ V}$ OR $V_{IN} = 1.8\text{ V}$, WHICHEVER IS GREATER, $V_{EN} = 1.2\text{ V}$, $I_{OUT} = 1\text{ mA}$, $C_{IN} = C_{OUT} = 1.0\text{ MF}$, $T_J = 25^\circ\text{C}$.

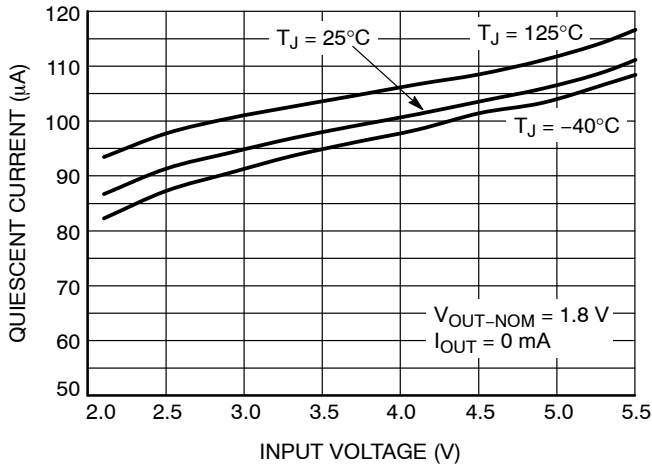

Figure 15. Quiescent Current vs. Input Voltage

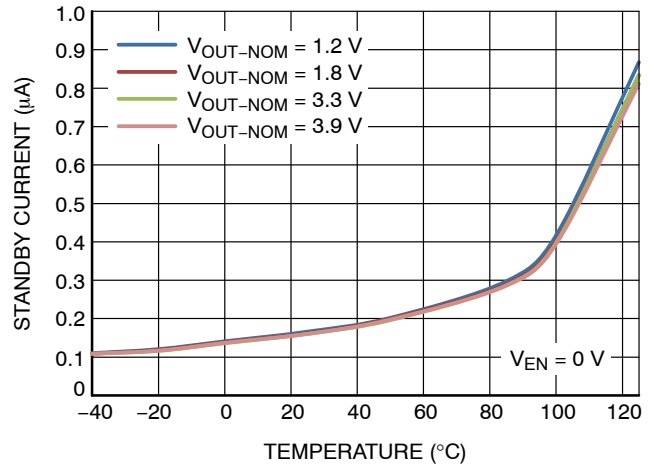

Figure 16. Standby Current vs. Temperature

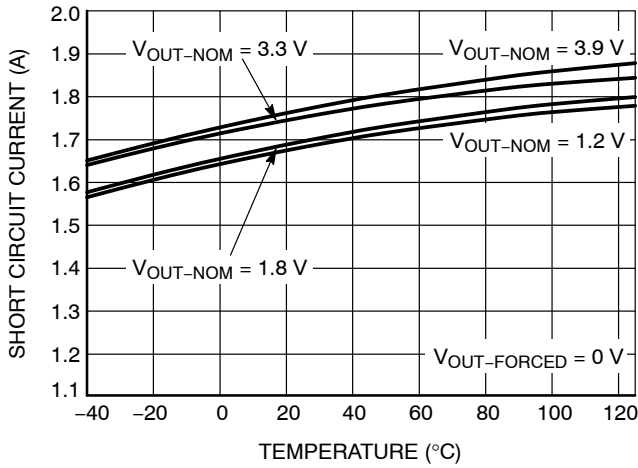

Figure 17. Short Circuit Current vs. Temperature

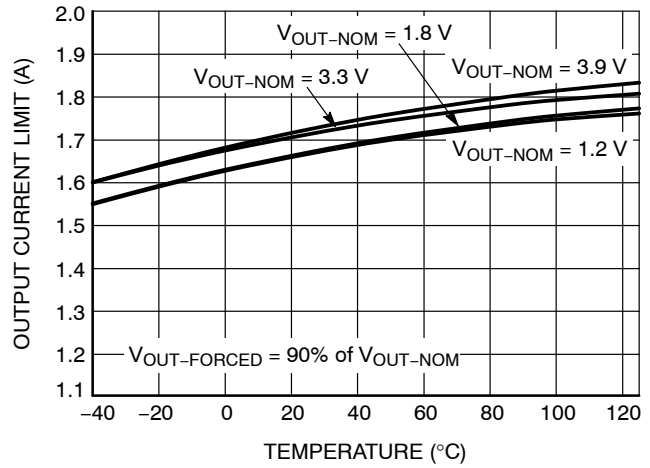

Figure 18. Output Current Limit vs. Temperature

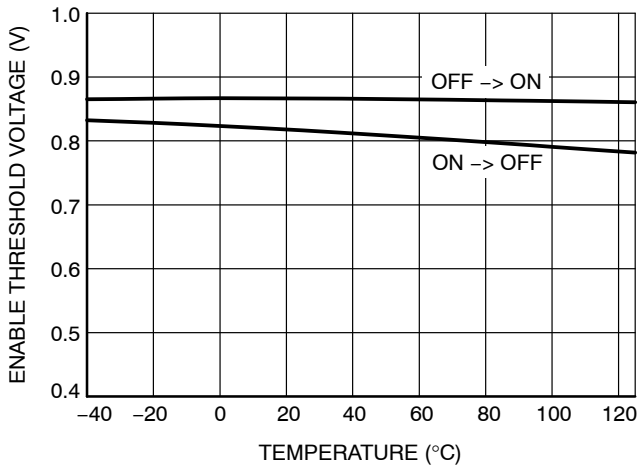

Figure 19. Enable Threshold Voltage vs. Temperature

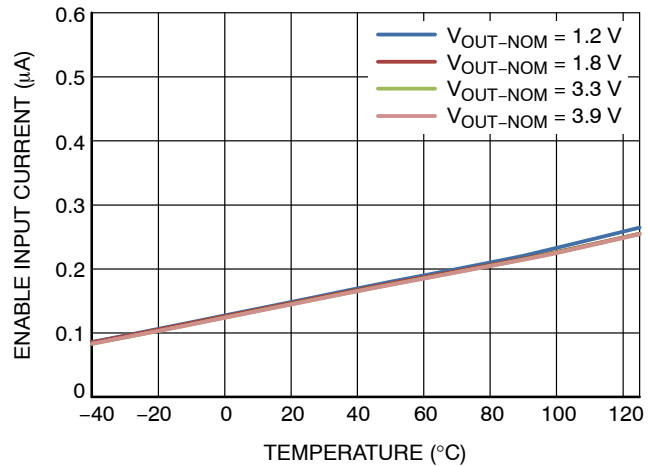

Figure 20. Enable Input Current vs. Temperature

NCP186

TYPICAL CHARACTERISTICS

$V_{IN} = V_{OUT-NOM} + 0.5 \text{ V}$ OR $V_{IN} = 1.8 \text{ V}$, WHICHEVER IS GREATER, $V_{EN} = 1.2 \text{ V}$, $I_{OUT} = 1 \text{ MA}$, $C_{IN} = C_{OUT} = 1.0 \text{ MF}$, $T_J = 25^\circ\text{C}$.

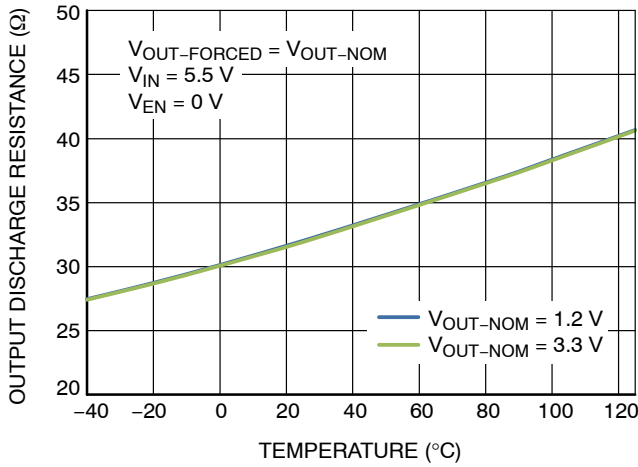

Figure 21. Output Discharge Resistance vs. Temperature (NCP186A option only)

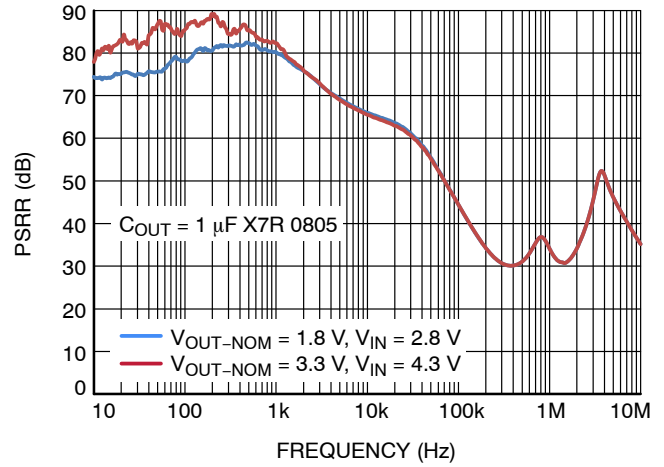

Figure 22. Power Supply Rejection Ratio

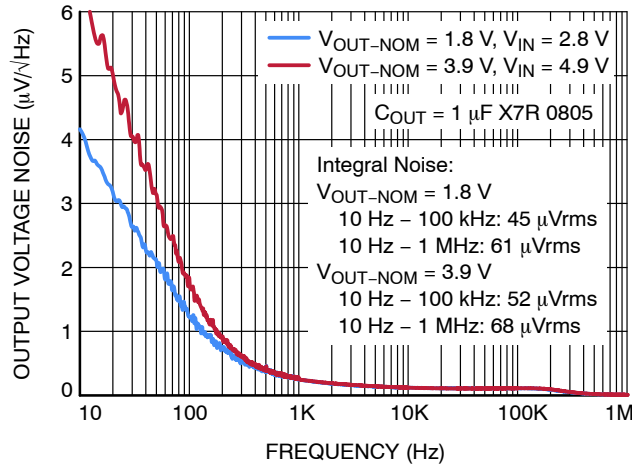

Figure 23. Output Voltage Noise Spectral Density

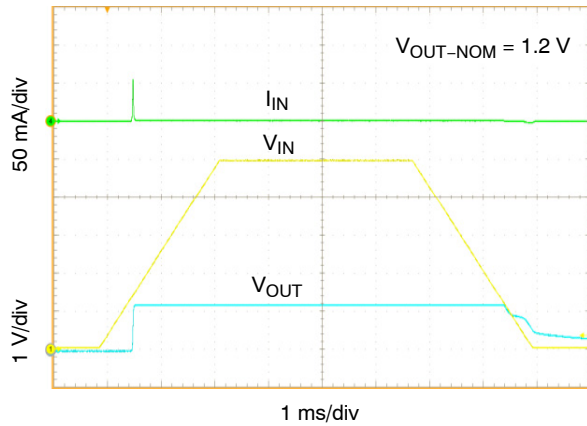

Figure 24. Turn-ON/OFF - VIN driven (slow)

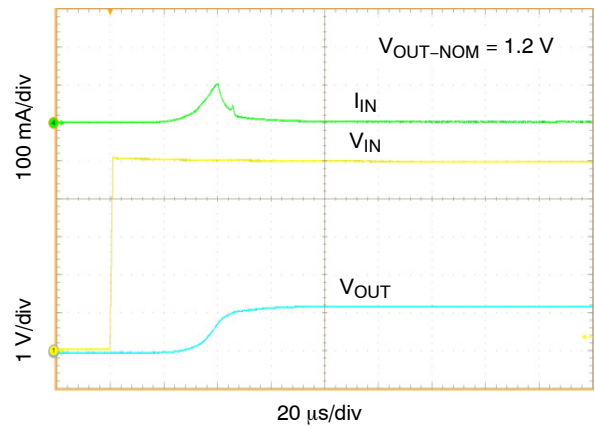

Figure 25. Turn-ON - VIN driven (fast)

TYPICAL CHARACTERISTICS

$V_{IN} = V_{OUT-NOM} + 0.5\text{ V}$ OR $V_{IN} = 1.8\text{ V}$, WHICHEVER IS GREATER, $V_{EN} = 1.2\text{ V}$, $I_{OUT} = 1\text{ MA}$, $C_{IN} = C_{OUT} = 1.0\text{ MF}$, $T_J = 25^\circ\text{C}$.

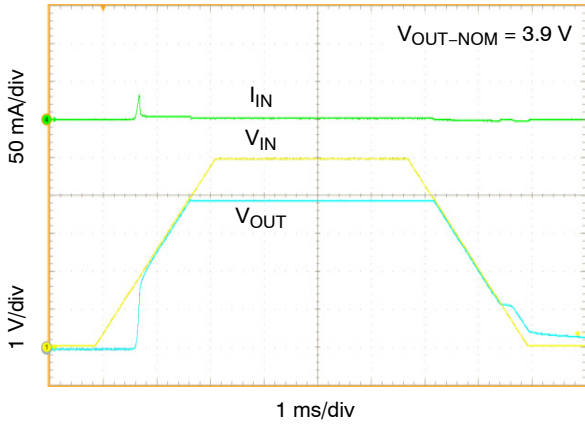

Figure 26. Turn-ON/OFF – VIN driven (slow)

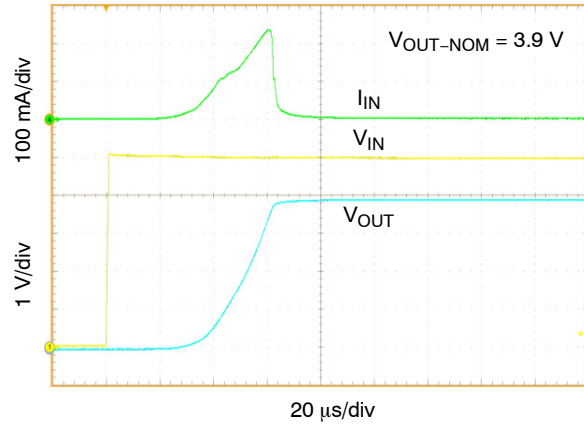

Figure 27. Turn-ON – VIN driven (fast)

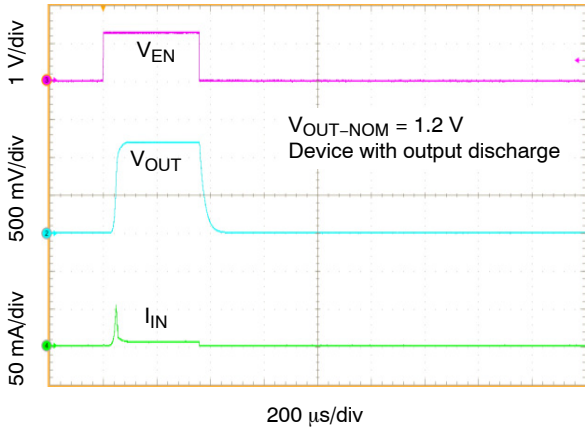

Figure 28. Turn-ON/OFF – EN driven

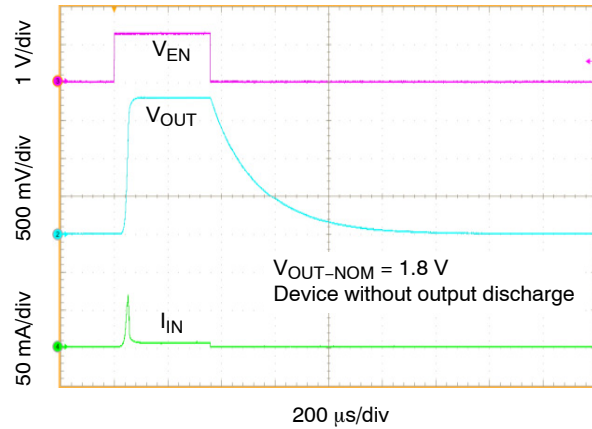

Figure 29. Turn-ON/OFF – EN driven

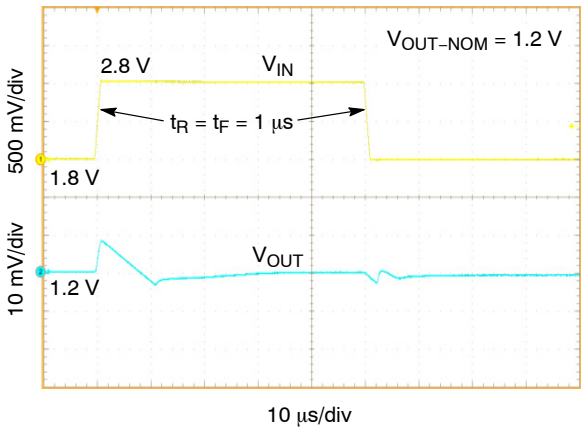

Figure 30. Line Transient Response

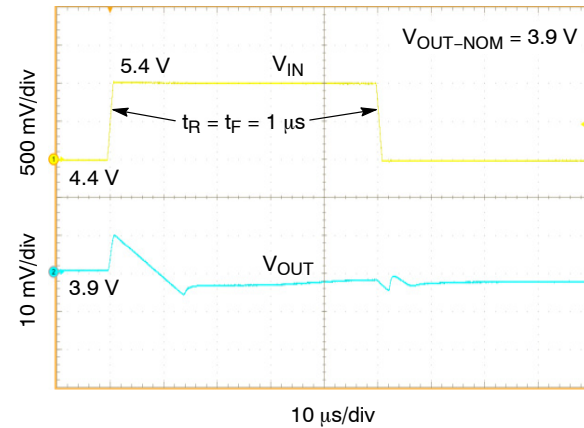

Figure 31. Line Transient Response

NCP186

TYPICAL CHARACTERISTICS

$V_{IN} = V_{OUT-NOM} + 0.5 \text{ V}$ OR $V_{IN} = 1.8 \text{ V}$, WHICHEVER IS GREATER, $V_{EN} = 1.2 \text{ V}$, $I_{OUT} = 1 \text{ mA}$, $C_{IN} = C_{OUT} = 1.0 \text{ MF}$, $T_J = 25^\circ\text{C}$.

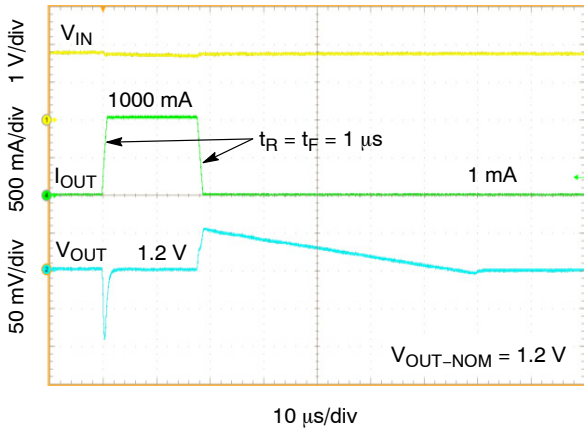

Figure 32. Load Transient Response

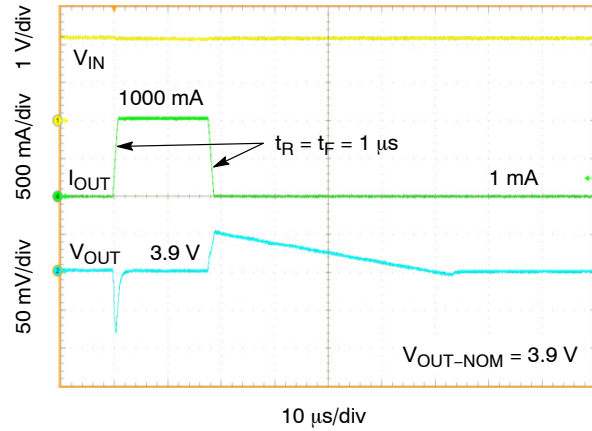

Figure 33. Load Transient Response

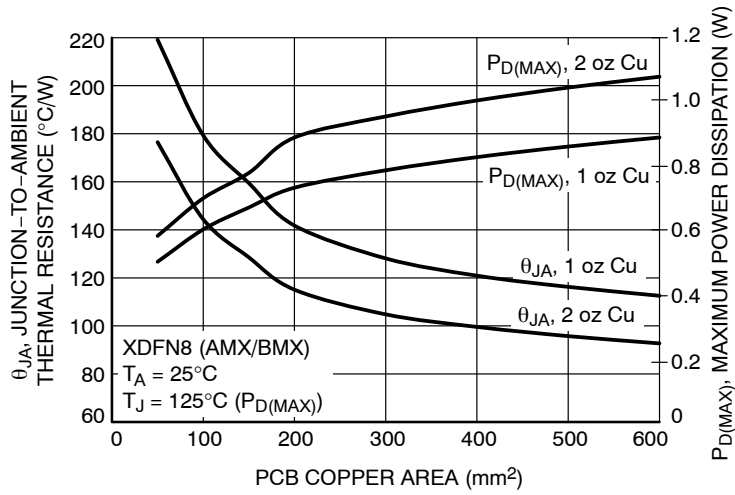

Figure 34. θ_{JA} and $P_{D(MAX)}$ vs. Copper Area

APPLICATIONS INFORMATION

General

The NCP186 is a high performance 1 A low dropout linear regulator (LDO) delivering excellent noise and dynamic performance. Thanks to its adaptive ground current behavior the device consumes only 90 μA typ. of quiescent current (no-load condition).

The regulator features low noise of 48 μV_{RMS} , PSRR of 75 dB at 1 kHz and very good line/load transient performance. Such excellent dynamic parameters, small dropout voltage and small package size make the device an ideal choice for powering the precision noise sensitive circuitry in portable applications.

A logic EN input provides ON/OFF control of the output voltage. When the EN is low the device consumes as low as 100 nA typ. from the IN pin.

The device is fully protected in case of output overload, output short circuit condition or overheating, assuring a very robust design.

Input Capacitor Selection (C_{IN})

Input capacitor connected as close as possible is necessary to ensure device stability. The X7R or X5R capacitor should be used for reliable performance over temperature range. The value of the input capacitor should be 1 μF or greater for the best dynamic performance. This capacitor will provide a low impedance path for unwanted AC signals or noise modulated onto the input voltage.

There is no requirement for the ESR of the input capacitor but it is recommended to use ceramic capacitor for its low ESR and ESL. A good input capacitor will limit the influence of input trace inductance and source resistance during load current changes.

Output Capacitor Selection (C_{OUT})

The LDO requires an output capacitor connected as close as possible to the output and ground pins. The recommended capacitor value is 1 μF , ceramic X7R or X5R type due to its low capacitance variations over the specified temperature range. The LDO is designed to remain stable with minimum effective capacitance of 0.8 μF . When selecting the capacitor the changes with temperature, DC bias and package size needs to be taken into account. Especially for small package size capacitors such as 0201 the effective capacitance drops rapidly with the applied DC bias voltage (refer the capacitor's datasheet for details).

There is no requirement for the minimum value of equivalent series resistance (ESR) for the C_{OUT} but the maximum value of ESR should be less than 0.5 Ω . Larger capacitance and lower ESR improves the load transient response and high frequency PSRR. Only ceramic capacitors are recommended, the other types like tantalum capacitors not due to their large ESR.

Enable Operation

The LDO uses the EN pin to enable/disable its operation and to deactivate/activate the output discharge function (A-version only).

If the EN pin voltage is < 0.4 V the device is disabled and the pass transistor is turned off so there is no current flow between the IN and OUT pins. On A-version the active discharge transistor is active so the output voltage is pulled to GND through 34 Ω (typ.) resistor.

If the EN pin voltage is > 1.0 V the device is enabled and regulates the output voltage. The active discharge transistor is turned off.

The EN pin has internal pull-down current source with value of 150 nA typ. which assures the device is turned off when the EN pin is unconnected. In case when the EN function isn't required the EN pin should be tied directly to IN pin.

Output Voltage

FB/ADJ pin could be connected to the output pin directly to compensate voltage drop across the internal bond wiring and PCB traces or to the middle point of the output resistor divider to adjust the output voltage.

When connected to the output pin the output voltage of the circuit is simply the same as the nominal output voltage of the LDO.

When connected to the resistor divider the output voltage is the nominal output voltage multiplied by the resistors divider ratio, see following equation. Corresponding schematic is shown at Figure 1.

$$V_{\text{OUT-ADJ}} = V_{\text{OUT-NOM}} \cdot \left(1 + \frac{R_1}{R_2} \right) \quad (\text{eq. 1})$$

Where:

- $V_{\text{OUT-ADJ}}$ is output voltage of the circuit with resistor divider
- $V_{\text{OUT-NOM}}$ is the LDO's nominal output voltage

For good stability and fast transient response chose the R_1 and R_2 values to have their currents I_{R1} and I_{R2} in range from 10 to 100 μA . The capacitor $C_1 = 1$ nF improves the stability and transient response as well.

Output Current Limit

Output current is internally limited to a 1.4 A typ. The LDO will source this current when the output voltage drops down from the nominal output voltage (test condition is $V_{\text{OUT-NOM}} - 100$ mV). If the output voltage is shorted to ground, the short circuit protection will limit the output current to 1.4 A typ. The current limit and short circuit protection will work properly over the whole temperature and input voltage ranges. There is no limitation for the short circuit duration.

Thermal Shutdown

When the LDO’s die temperature exceeds the thermal shutdown threshold value the device is internally disabled. The IC will remain in this state until the die temperature decreases by value called thermal shutdown hysteresis. Once the IC temperature falls this way the LDO is back enabled. The thermal shutdown feature provides the protection against overheating due to some application failure and it is not intended to be used as a normal working function.

Power Dissipation

Power dissipation caused by voltage drop across the LDO and by the output current flowing through the device needs to be dissipated out from the chip. The maximum power dissipation is dependent on the PCB layout, number of used Cu layers, Cu layers thickness and the ambient temperature. The maximum power dissipation can be computed by following equation:

$$P_{D(MAX)} = \frac{T_J - T_A}{\theta_{JA}} [W] \quad (\text{eq. 2})$$

Where $(T_J - T_A)$ is the temperature difference between the junction and ambient temperatures and θ_{JA} is the thermal resistance (dependent on the PCB as mentioned above).

The power dissipated by the LDO for given application conditions can be calculated by the next equation:

$$P_D = V_{IN} \cdot I_{GND} + (V_{IN} - V_{OUT}) \cdot I_{OUT} [W] \quad (\text{eq. 3})$$

Where I_{GND} is the LDO’s ground current, dependent on the output load current.

Connecting the exposed pad and N/C pin to a large ground planes helps to dissipate the heat from the chip.

The relation of θ_{JA} and $P_{D(MAX)}$ to PCB copper area and Cu layer thickness could be seen on the Figure 34.

Reverse Current

The PMOS pass transistor has an inherent body diode which will be forward biased in the case when $V_{OUT} > V_{IN}$. Due to this fact in cases, where the extended reverse current condition can be anticipated the device may require additional external protection.

Power Supply Rejection Ratio

The LDO features very high power supply rejection ratio. The PSRR at higher frequencies (in the range above 100 kHz) can be tuned by the selection of C_{OUT} capacitor and proper PCB layout. A simple LC filter could be added to the LDO’s IN pin for further PSRR improvement.

Enable Turn-On Time

The enable turn-on time is defined as the time from EN assertion to the point in which V_{OUT} will reach 98% of its nominal value. This time is dependent on various application conditions such as $V_{OUT-NOM}$, C_{OUT} and T_A .

PCB Layout Recommendations

To obtain good transient performance and good regulation characteristics place C_{IN} and C_{OUT} capacitors as close as possible to the device pins and make the PCB traces wide. In order to minimize the solution size, use 0402 or 0201 capacitors size with appropriate effective capacitance.

Larger copper area connected to the pins will also improve the device thermal resistance. The actual power dissipation can be calculated from the equation above (Power Dissipation section). Exposed pad and N/C pin should be tied to the ground plane for good power dissipation.

NCP186

ORDERING INFORMATION TABLE

Part Number	Voltage Option (V _{OUT-NOM})	Marking	Option	Package	Shipping
NCP186AMN080TBG	0.8 V	ADJ	With active discharge	DFN12 (Pb-Free)	3000 / Tape & Reel
NCP186AMX120TAG (Note 6)	1.2 V	FA		XDFN8 (Pb-Free)	3000 or 5000 / Tape & Reel (Note 6)
NCP186AMX150TAG (Note 6)	1.5 V	FN			
NCP186AMX175TAG (Note 6)	1.75 V	FC			
NCP186AMX180TAG (Note 6)	1.8 V	FD			
NCP186AMX185TAG	1.85 V	FL			
NCP186AMX250TAG (Note 6)	2.5 V	FE			
NCP186AMX280TAG (Note 6)	2.8 V	FF			
NCP186AMX295TAG (Note 6)	2.95 V	FP			
NCP186AMX300TAG (Note 6)	3.0 V	FG			
NCP186AMX330TAG (Note 6)	3.3 V	FH			
NCP186AMX350TAG	3.5 V	FJ			
NCP186AMX390TAG (Note 6)	3.9 V	FK			
NCP186BMX120TAG	1.2 V	HA	Without active discharge	XDFN8 (Pb-Free)	3000 or 5000 / Tape & Reel (Note 6)
NCP186BMX150TAG (Note 6)	1.5 V	HN			
NCP186BMX175TAG	1.75 V	HC			
NCP186BMX180TAG (Note 6)	1.8 V	HD			
NCP186BMX185TAG (Note 6)	1.85 V	HL			
NCP186BMX250TAG (Note 6)	2.5 V	HE			
NCP186BMX280TAG	2.8 V	HF			
NCP186BMX300TAG	3.0 V	HG			
NCP186BMX330TAG (Note 6)	3.3 V	HH			
NCP186BMX350TAG	3.5 V	HJ			
NCP186BMX390TAG	3.9 V	HK			

†For information on tape and reel specifications, including part orientation and tape sizes, please refer to our Tape and Reel Packaging Specifications Brochure, BRD8011/D.

6. Product processed after October 1, 2022 are shipped with quantity 5000 units / tape & reel.

MECHANICAL CASE OUTLINE

PACKAGE DIMENSIONS

ON Semiconductor®



SCALE 4:1

XDFN8 1.6x1.2, 0.4P CASE 711AS ISSUE D

DATE 08 DEC 2015

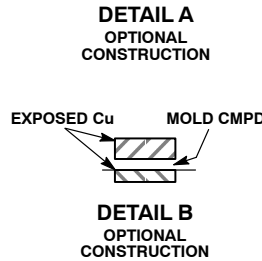
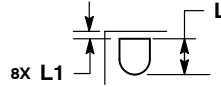
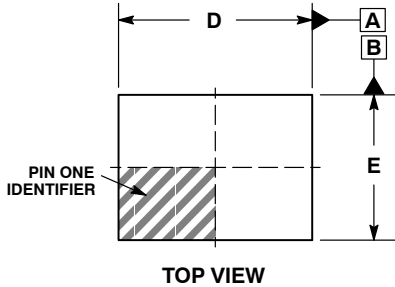

NOTES:

1. DIMENSIONING AND TOLERANCING PER ASME Y14.5M, 1994.
2. CONTROLLING DIMENSION: MILLIMETERS.
3. COPLANARITY APPLIES TO THE EXPOSED PAD AS WELL AS THE TERMINALS.

DIM	MILLIMETERS		
	MIN	NOM	MAX
A	0.300	0.375	0.450
A1	0.000	0.025	0.050
b	0.130	0.180	0.230
D	1.500	1.600	1.700
D2	1.200	1.300	1.400
E	1.100	1.200	1.300
E2	0.200	0.300	0.400
e	0.40 BSC		
L	0.150	0.200	0.250
L1	0.000	0.050	0.100

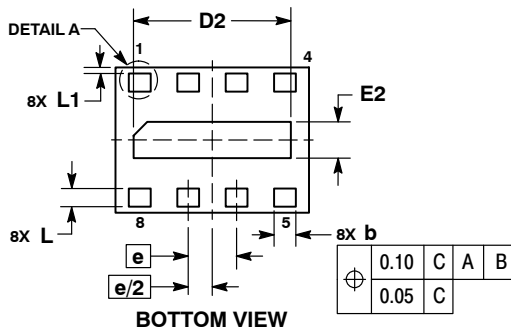
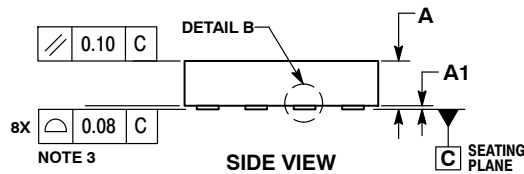

GENERIC MARKING DIAGRAM*

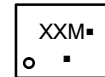

- XX = Specific Device Code
- M = Date Code
- = Pb-Free Package

(Note: Microdot may be in either location)

*This information is generic. Please refer to device data sheet for actual part marking. Pb-Free indicator, "G" or microdot "▪", may or may not be present.

RECOMMENDED MOUNTING FOOTPRINT*

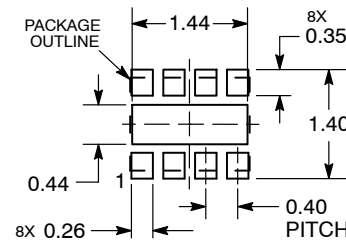

DIMENSIONS: MILLIMETERS

*For additional information on our Pb-Free strategy and soldering details, please download the ON Semiconductor Soldering and Mounting Techniques Reference Manual, SOLDERRM/D.

DOCUMENT NUMBER:	98AON87768E	Electronic versions are uncontrolled except when accessed directly from the Document Repository. Printed versions are uncontrolled except when stamped "CONTROLLED COPY" in red.
DESCRIPTION:	XDFN8, 1.6X1.2, 0.4P	PAGE 1 OF 1

ON Semiconductor and are trademarks of Semiconductor Components Industries, LLC dba ON Semiconductor or its subsidiaries in the United States and/or other countries. ON Semiconductor reserves the right to make changes without further notice to any products herein. ON Semiconductor makes no warranty, representation or guarantee regarding the suitability of its products for any particular purpose, nor does ON Semiconductor assume any liability arising out of the application or use of any product or circuit, and specifically disclaims any and all liability, including without limitation special, consequential or incidental damages. ON Semiconductor does not convey any license under its patent rights nor the rights of others.

onsemi, **Onsemi**, and other names, marks, and brands are registered and/or common law trademarks of Semiconductor Components Industries, LLC dba "**onsemi**" or its affiliates and/or subsidiaries in the United States and/or other countries. **onsemi** owns the rights to a number of patents, trademarks, copyrights, trade secrets, and other intellectual property. A listing of **onsemi**'s product/patent coverage may be accessed at www.onsemi.com/site/pdf/Patent-Marking.pdf. **onsemi** reserves the right to make changes at any time to any products or information herein, without notice. The information herein is provided "as-is" and **onsemi** makes no warranty, representation or guarantee regarding the accuracy of the information, product features, availability, functionality, or suitability of its products for any particular purpose, nor does **onsemi** assume any liability arising out of the application or use of any product or circuit, and specifically disclaims any and all liability, including without limitation special, consequential or incidental damages. Buyer is responsible for its products and applications using **onsemi** products, including compliance with all laws, regulations and safety requirements or standards, regardless of any support or applications information provided by **onsemi**. "Typical" parameters which may be provided in **onsemi** data sheets and/or specifications can and do vary in different applications and actual performance may vary over time. All operating parameters, including "Typicals" must be validated for each customer application by customer's technical experts. **onsemi** does not convey any license under any of its intellectual property rights nor the rights of others. **onsemi** products are not designed, intended, or authorized for use as a critical component in life support systems or any FDA Class 3 medical devices or medical devices with a same or similar classification in a foreign jurisdiction or any devices intended for implantation in the human body. Should Buyer purchase or use **onsemi** products for any such unintended or unauthorized application, Buyer shall indemnify and hold **onsemi** and its officers, employees, subsidiaries, affiliates, and distributors harmless against all claims, costs, damages, and expenses, and reasonable attorney fees arising out of, directly or indirectly, any claim of personal injury or death associated with such unintended or unauthorized use, even if such claim alleges that **onsemi** was negligent regarding the design or manufacture of the part. **onsemi** is an Equal Opportunity/Affirmative Action Employer. This literature is subject to all applicable copyright laws and is not for resale in any manner.

ADDITIONAL INFORMATION

TECHNICAL PUBLICATIONS:

Technical Library: www.onsemi.com/design/resources/technical-documentation
onsemi Website: www.onsemi.com

ONLINE SUPPORT: www.onsemi.com/support

For additional information, please contact your local Sales Representative at www.onsemi.com/support/sales