

FEATURES

* International standard package

APPLICATIONS

- * DC motor control
- * Softstart AC motor controller
- * Light, heat and temperature control

ADVANTAGES

- * Space and weight savings
- * Simple mounting with two screws
- * Improved temperature and power cycling
- * Reduced protection circuits

Symbol	Test Conditions	Maximum Ratings	Unit
I_{TRMS} , I_{FRMS} I_{TAVM} , I_{FAVM}	$T_{VJ}=T_{VJM}$ $T_C=85^{\circ}C$; 180° sine	800 500	A
I_{TSM} , I_{FSM}	$T_{VJ}=45^{\circ}C$ $t=10ms$ (50Hz), sine $V_R=0$ $t=8.3ms$ (60Hz), sine	15000 16000	A
	$T_{VJ}=T_{VJM}$ $t=10ms$ (50Hz), sine $V_R=0$ $t=8.3ms$ (60Hz), sine	13000 14400	
i_{zdt}	$T_{VJ}=45^{\circ}C$ $t=10ms$ (50Hz), sine $V_R=0$ $t=8.3ms$ (60Hz), sine	1125000 1062600	A _{2s}
	$T_{VJ}=T_{VJM}$ $t=10ms$ (50Hz), sine $V_R=0$ $t=8.3ms$ (60Hz), sine	845000 813000	
$(di/dt)_{cr}$	$T_{VJ}=T_{VJM}$ repetitive, $I_T=45A$ $f=50Hz$, $t_p=200\mu s$ $V_D=2/3V_{DRM}$ $I_G=0.45A$ non repetitive, $I_T=I_{TAVM}$ $di_G/dt=0.45A/\mu s$	100 500	A/ μs
$(dv/dt)_{cr}$	$T_{VJ}=T_{VJM}$; $V_{DR}=2/3V_{DRM}$ $R_{GK} =$; method 1 (linear voltage rise)	1000	V/ μs
P_{GM}	$T_{VJ}=T_{VJM}$ $t_p=30\mu s$	120	W
	$I_T=I_{TAVM}$ $t_p=300\mu s$	60	
P_{GAV}		20	W
V_{RGM}		10	V
T_{VJ} T_{VJM} T_{stg}		-40...+125	°C
		125	
		-40...+125	
V_{ISOL}	50/60Hz, RMS $t=1min$	3000	V~
	$I_{ISOL}<1mA$ $t=1s$	3600	
M_d	Mounting torque (M5)	2.5-4.0/22-35	Nm/lb.in.
	Terminal connection torque (M5)	2.5-4.0/22-35	
Weight	Typical including screws	1.6	kg

Symbol	Test Conditions	Maximum Ratings	Unit
IRRM, IDRM	TVJ=TVJM; VR=VRRM; VD=VDRM	40	mA
VT, VF	IT, IF=630A; TVJ=25oC	1.40	V
VTO	For power-loss calculations only (TVJ=125oC)	1.10	V
rT		0.38	mΩ
VGT	VD=6V; TVJ=25oC	2	V
	TVJ=-40oC	3	
IGT	VD=6V; TVJ=25oC	300	mA
	TVJ=-40oC	400	
VGD	TVJ=TVJM; VD=2/3VDRM	0.25	V
IGD		10	mA
IL	TVJ=25oC; tp=10us; VD=6V	400	mA
	IL IG=0.45A; diG/dt=0.45A/us		
IH	TVJ=25oC; VD=6V; RGK=	300	mA
tgD	TVJ=25oC; VD=1/2VDRM IG=0.45A; diG/dt=0.45A/us	2	us
tq	TVJ=TVJM; IT=20A; tp=200us; -di/dt=10A/us typ. VR=100V; dv/dt=20V/us; VD=2/3VDRM	350	us
QS	TVJ=TVJM; IT, IF=25A; -di/dt=0.64A/us	760	uC
IRM		275	A
RthJC	per thyristor/diode; DC current	0.129	K/W
	per module	0.0645	
RthJK	per thyristor/diode; DC current	0.169	K/W
	per module	0.0845	
dS	Creeping distance on surface	12.7	mm
dA	Strike distance through air	9.6	mm
a	Maximum allowable acceleration	50	m/s ²

Outline Table

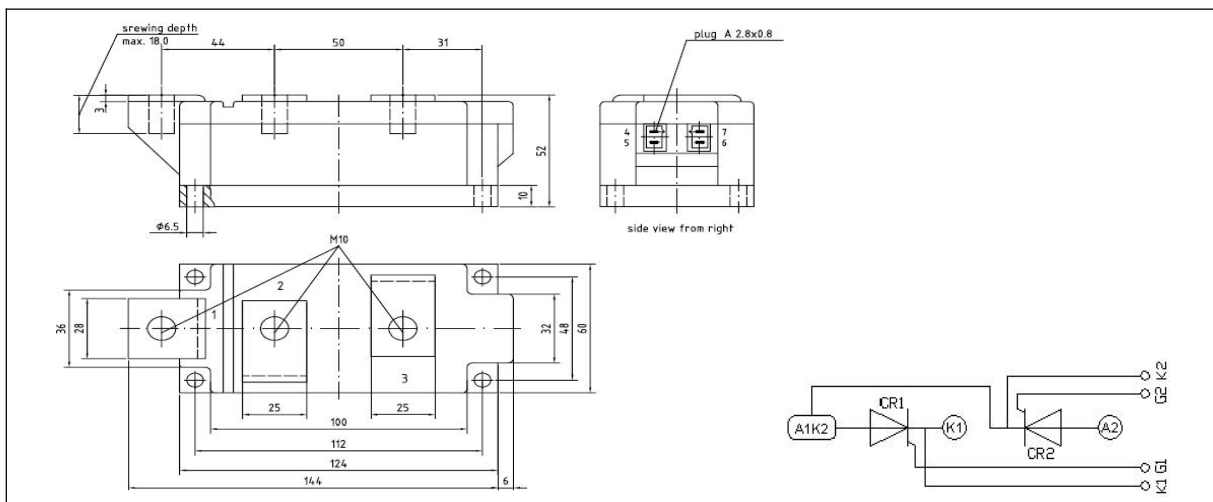

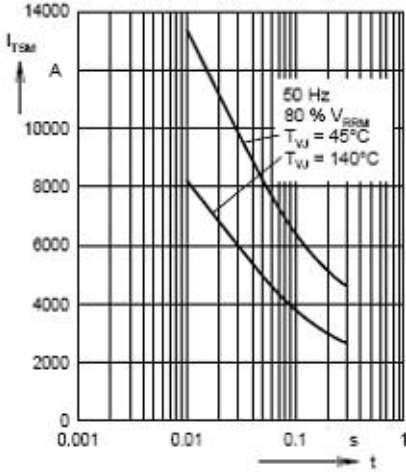

Fig. 1 Surge overload current
 I_{TSM} , I_{FSM} : Crest value, t : duration

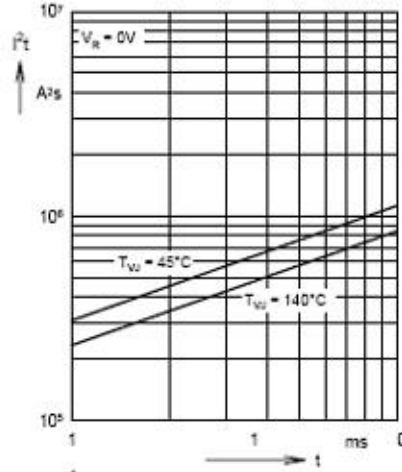

Fig. 2 I^2t versus time (1-10 ms)

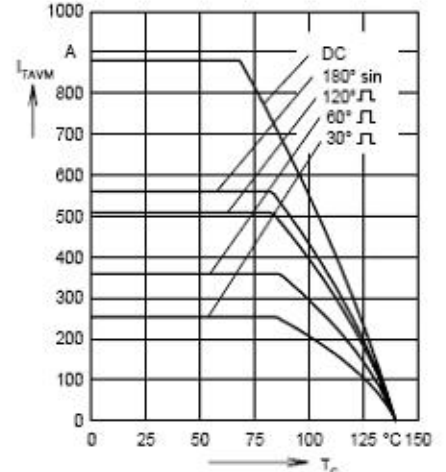

Fig. 3 Maximum forward current at case temperature

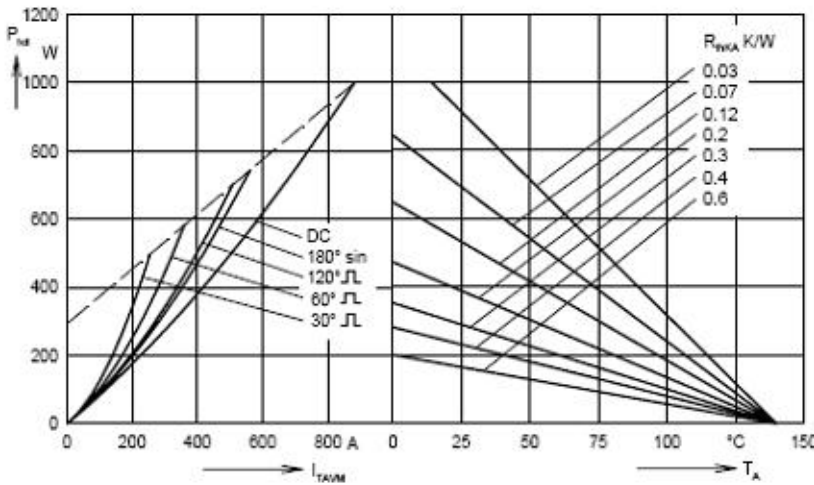

Fig. 4 Power dissipation versus on-state current and ambient temperature

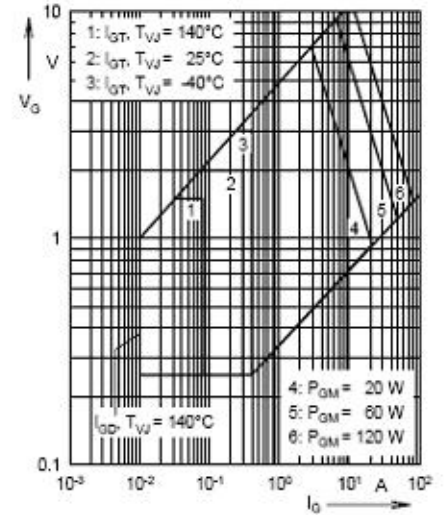

Fig. 5 Gate trigger characteristics

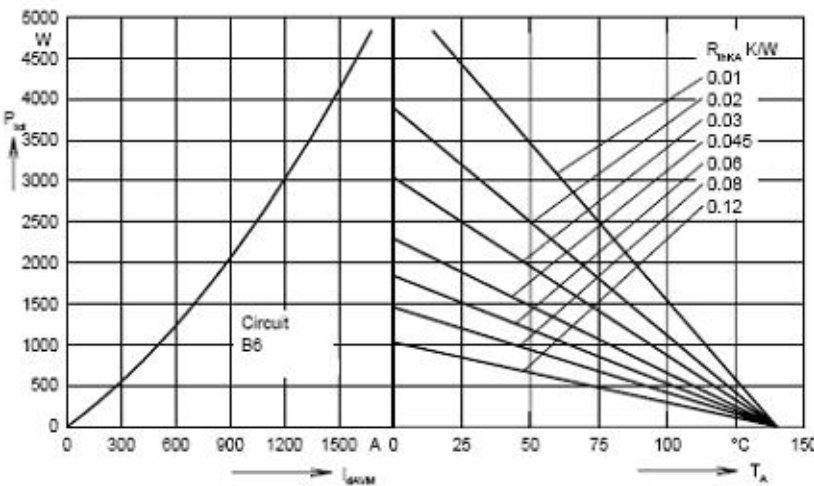

Fig. 6 Three phase rectifier bridge: Power dissipation versus direct output current and ambient temperature

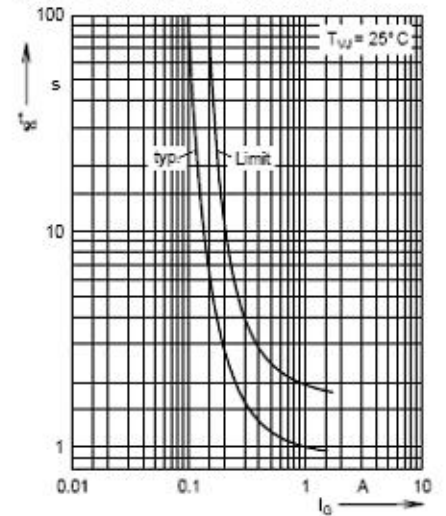

Fig. 7 Gate trigger delay time

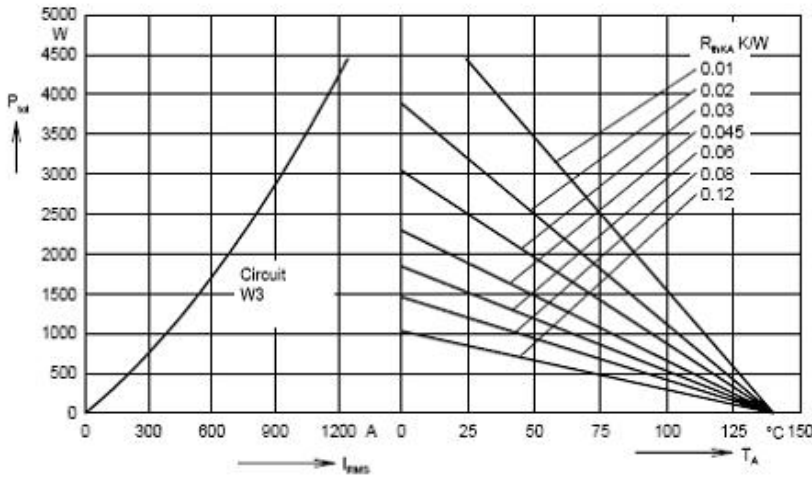

Fig. 8 Three phase AC-controller: Power dissipation versus RMS output current and ambient temperature

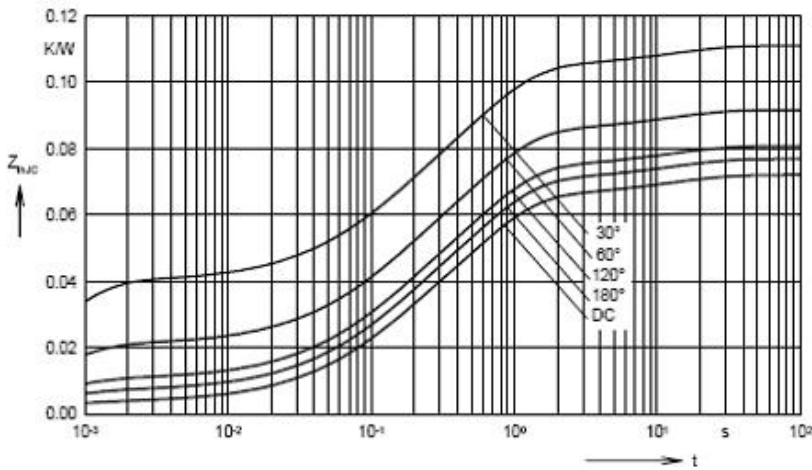

Fig. 9 Transient thermal impedance junction to case (per thyristor)

R_{thJC} for various conduction angles d:

d	R_{thJC} (K/W)
DC	0.072
180°C	0.0768
120°C	0.081
60°C	0.092
30°C	0.111

Constants for Z_{thJC} calculation:

i	R_{m_i} (K/W)	t_i (s)
1	0.0035	0.0054
2	0.0186	0.098
3	0.0432	0.54
4	0.0067	12

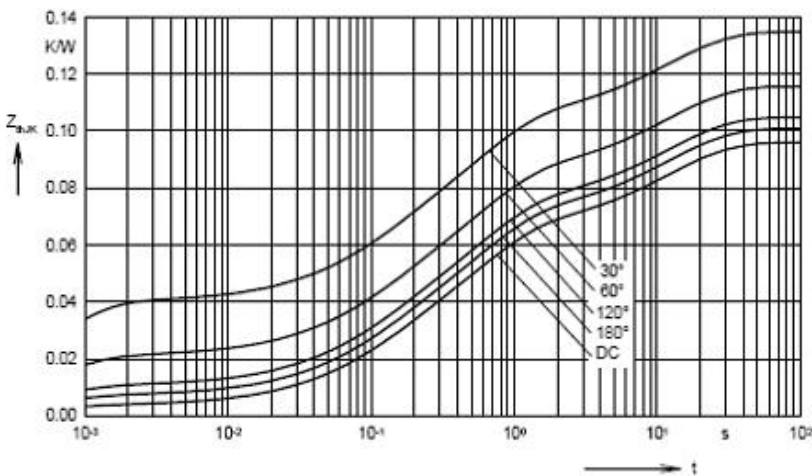

Fig.10 Transient thermal impedance junction to heatsink (per thyristor)

R_{thJK} for various conduction angles d:

d	R_{thJK} (K/W)
DC	0.096
180°C	0.1
120°C	0.105
60°C	0.116
30°C	0.135

Constants for Z_{thJK} calculation:

i	R_{m_i} (K/W)	t_i (s)
1	0.0035	0.0054
2	0.0186	0.098
3	0.0432	0.54
4	0.0067	12
5	0.024	12