

DETAILS

Product Number	C12727_STRADA-SQ-VSM
Family	Strada-SQ
Type	Lens
Color	clear
Diameter	25 x 25 mm
Height	6,8 mm
Style	square
Optic Material	PMMA
Holder Material	
Fastening	glue, screw, pin
Status	production ready
ROHS Compliant	Yes
Date Updated	20/09/2016



OPTICAL PROPERTIES

LED	Viewing Angle	Light Beam	Efficiency	cd/lm	Connector
XM-L	154 deg	Streetligh...	93 %	0.200	-
XT-E	151 deg	Streetligh...	93 %	0.200	-
XP-G2	149 deg	Streetligh...	94 %	0.700	-
XM-L2	155 deg	Streetligh...	94 %	0.400	-
XP-E2	149 deg	Streetligh...	94 %	0.800	-
XP-L	152 deg	Streetligh...	94 %	0.480	-
XHP50	154 deg	Streetligh...	94 %	0.330	-
XP-L2	149 deg	Streetligh...	94 %	0.400	-
H35C1 (LEMWA33)	151 deg	Streetligh...	94 %	0.670	-
LUXEON M	154 deg	Streetligh...	93 %	0.250	-
LUXEON MZ	148 deg	Streetligh...	94 %	0.410	-
NFMW48xA	148 deg	Streetligh...	94 %	0.390	-
Duris P10	sim: 150	Streetligh...	sim: 90 %	sim: 0.357	-
Oslo Square Gen3	sim: 144	Streetligh...	sim: 98 %	-	-

D

C

B

A

4

4

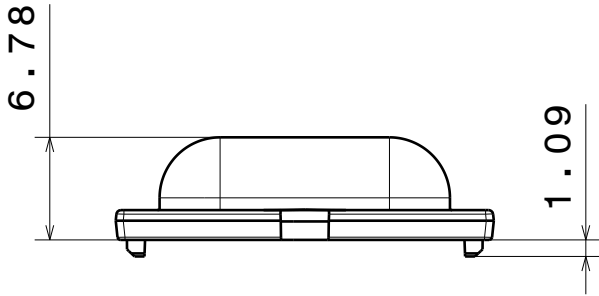

Front view

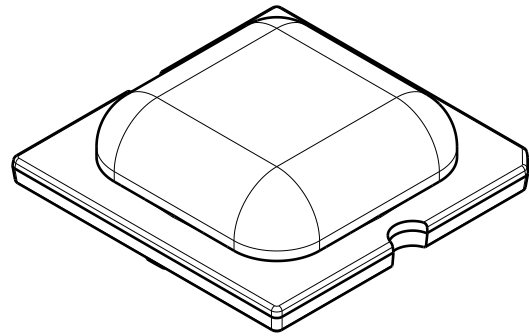

Isometric view

3

3

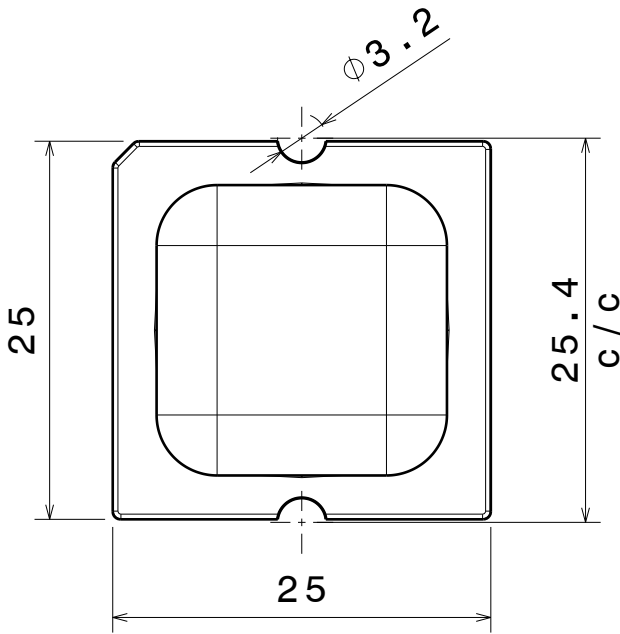

Top view

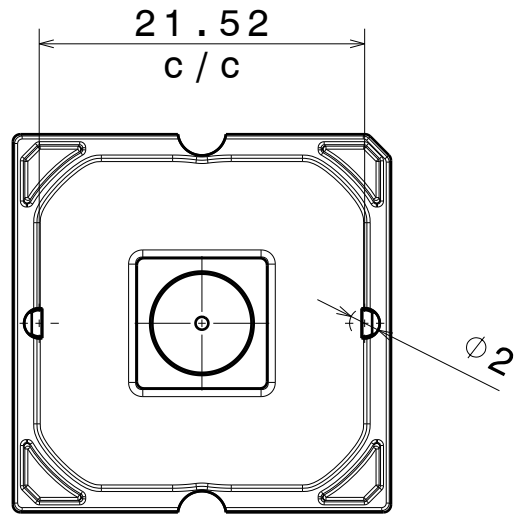

Bottom view

2

2

INDEX	PART NO	DESCRIPTION	MATERIAL	COLOUR
1	C12727	STRADA-SQ-VSM	PMMA	clear

Tolerances if not otherwise shown
 According to DIN ISO 2768-1
 Linear measures: class C
 According to DIN ISO 2768-2
 Form and position: class L



Ledil Oy
 Salorankatu 10
 FIN 24240 SALO
 Finland

THIRD ANGLE PROJECTION:

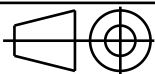

DRAWING TITLE

C12727_STRADA-SQ-VSM

This drawing is the property
 of LEDiL Oy. It may not be
 reproduced, copied or
 communicated without a written
 agreement with LEDiL Oy.

SIZE PART NUMBER

A4

C12727

SCALE 2:1 WEIGHT 2,45 g SHEET 1/1

D

A

1

1

Luminaire: LEDiL Oy C12727_STRADA-SQ-VSM_(XM-L) Eff.93%
Lamps: 1 x CREE_XM-L_78.0576lm@250mA_P=0.71104W_I=249.9mA

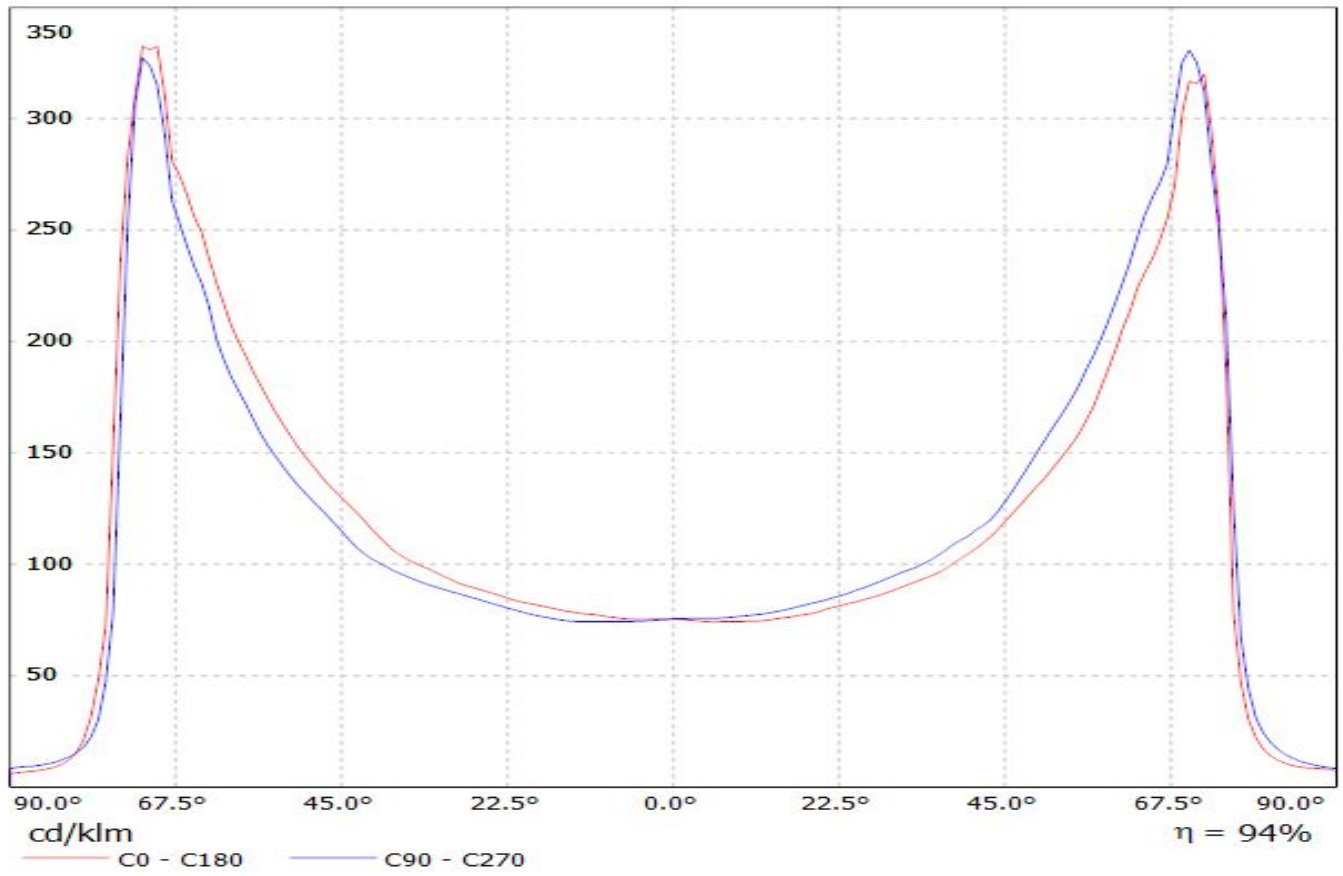

Luminaire: LEDiL Oy C12727_STRADA-SQ-VSM_(XT-E) Eff. 93%
Lamps: 1 x Cree XT-E 100lm @ 250mA

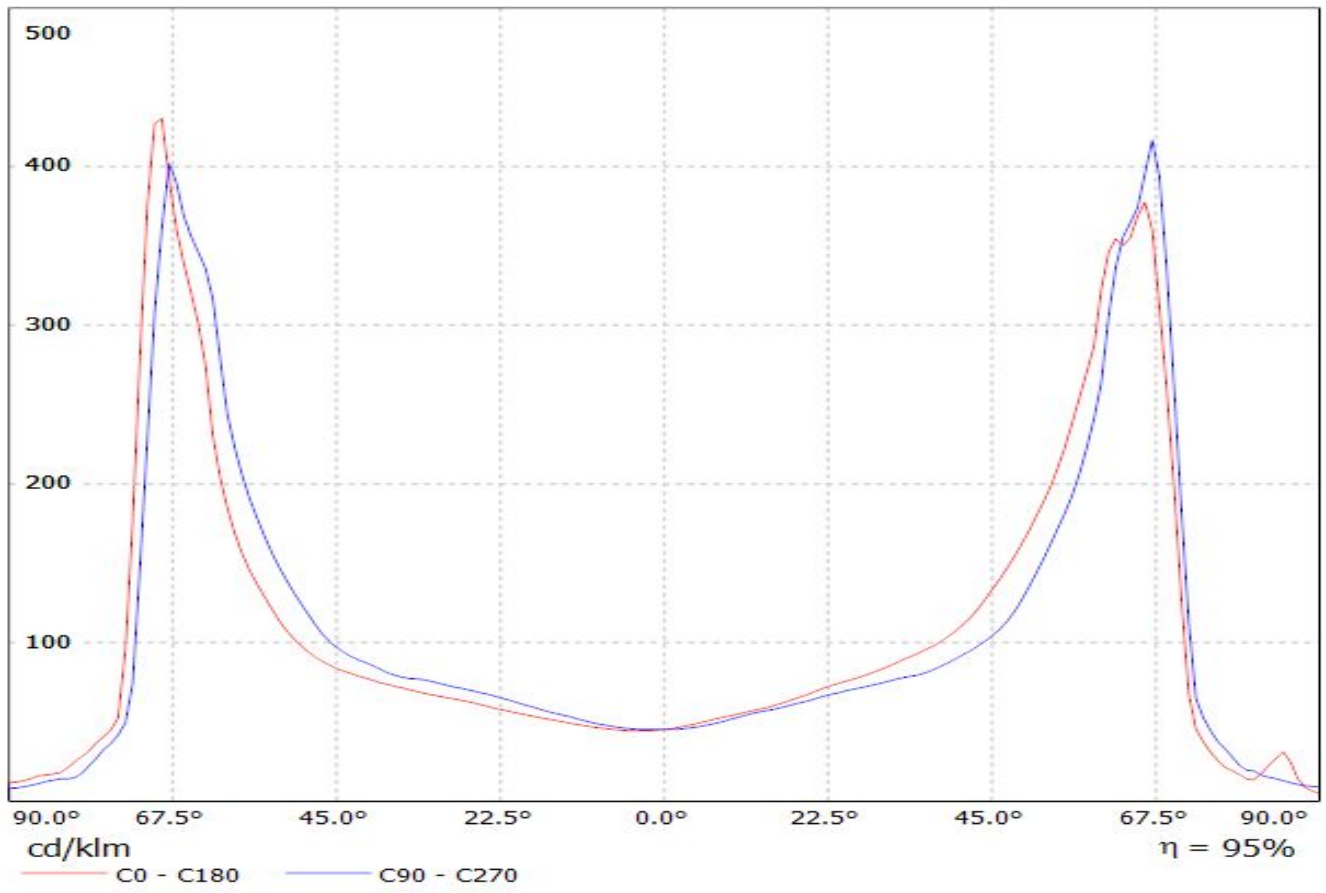

Valaisin: LEDIL OY C12727_STRADA-SQ-VSM (XP-G2) Efficiency=95%
Lamput: 1 x Cree XP-G2 (109.1lm @ 250mA)

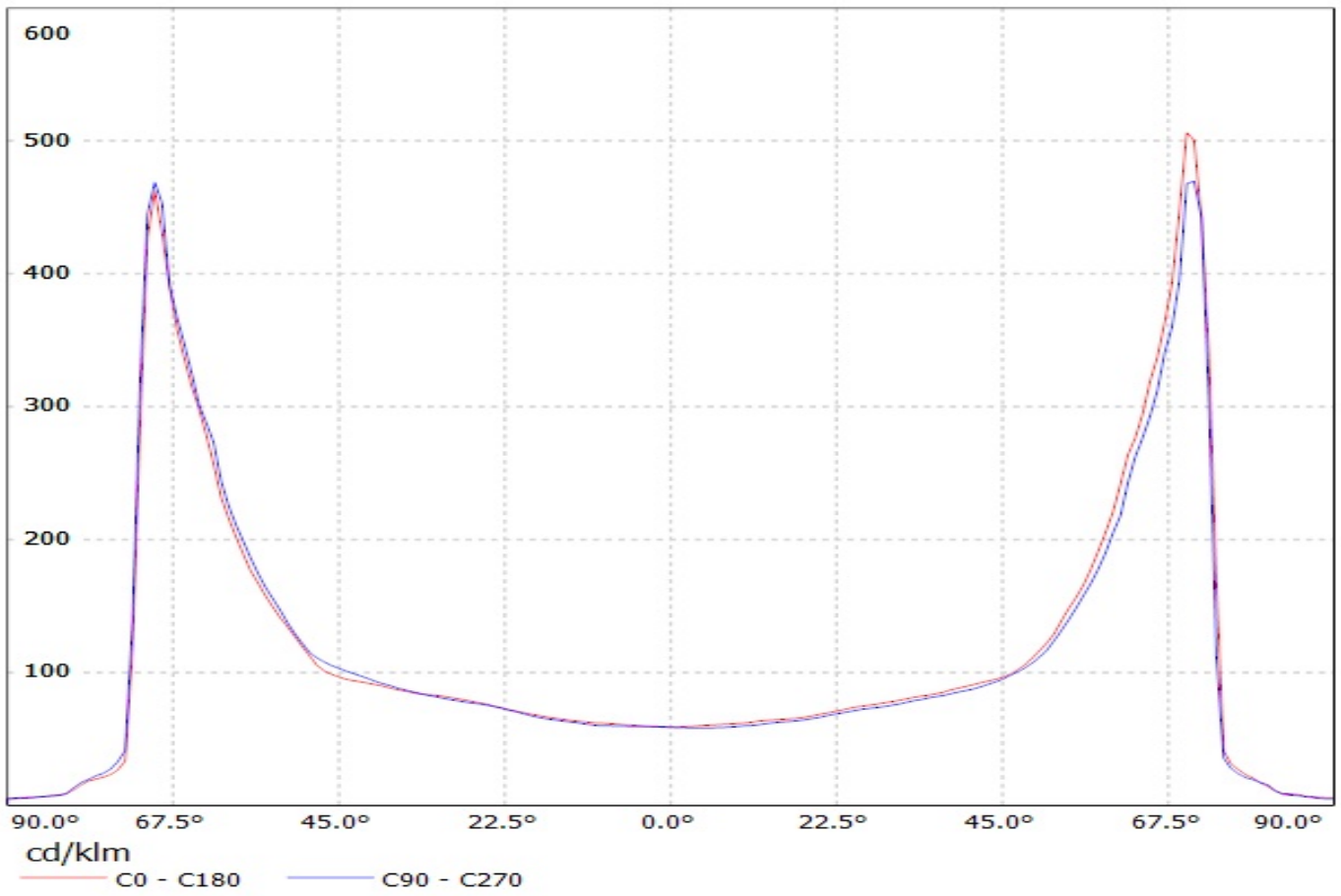

Luminaire: LEDil Oy C12727_STRADA-SQ-VSM_(XM-L2) Efficiency=94%
Lamps: 1 x Cree XM-L2 (XMLBWT-0-7B4-T30-0L-0001) 91lm @ 250mA CCT=3200K P=0.7W I=250mA

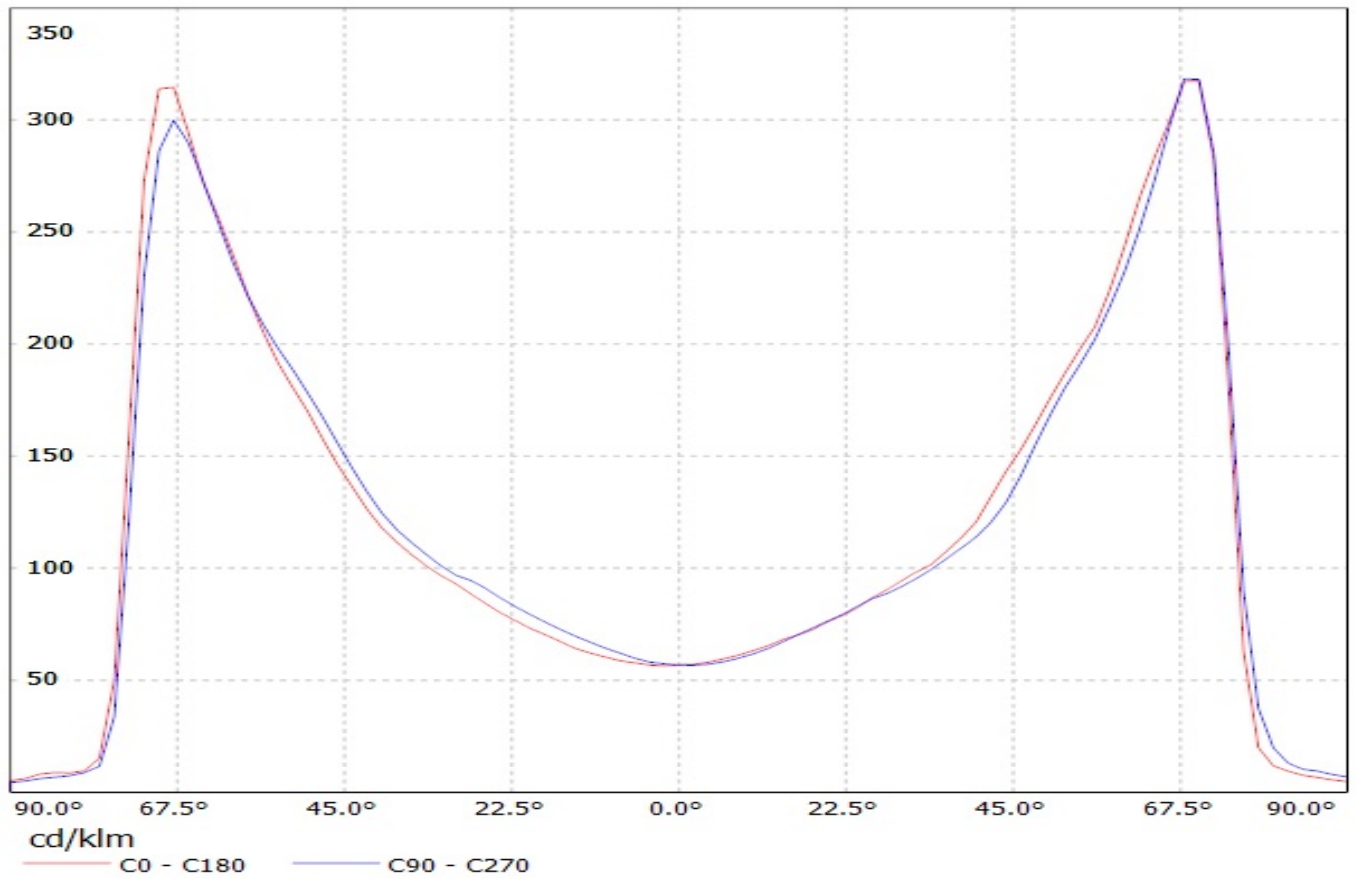

Luminaire: LEDiL Oy C12727_STRADA-SQ-VSM_(XP-E2) Eff: 94%

Lamps: 1 x CREE_XP-E2_(XPEBWT-L1-7B4-Q4-0-01)_82.2649lm@250mA_P=0.753923W_CCT=3194K_I=249.9mA

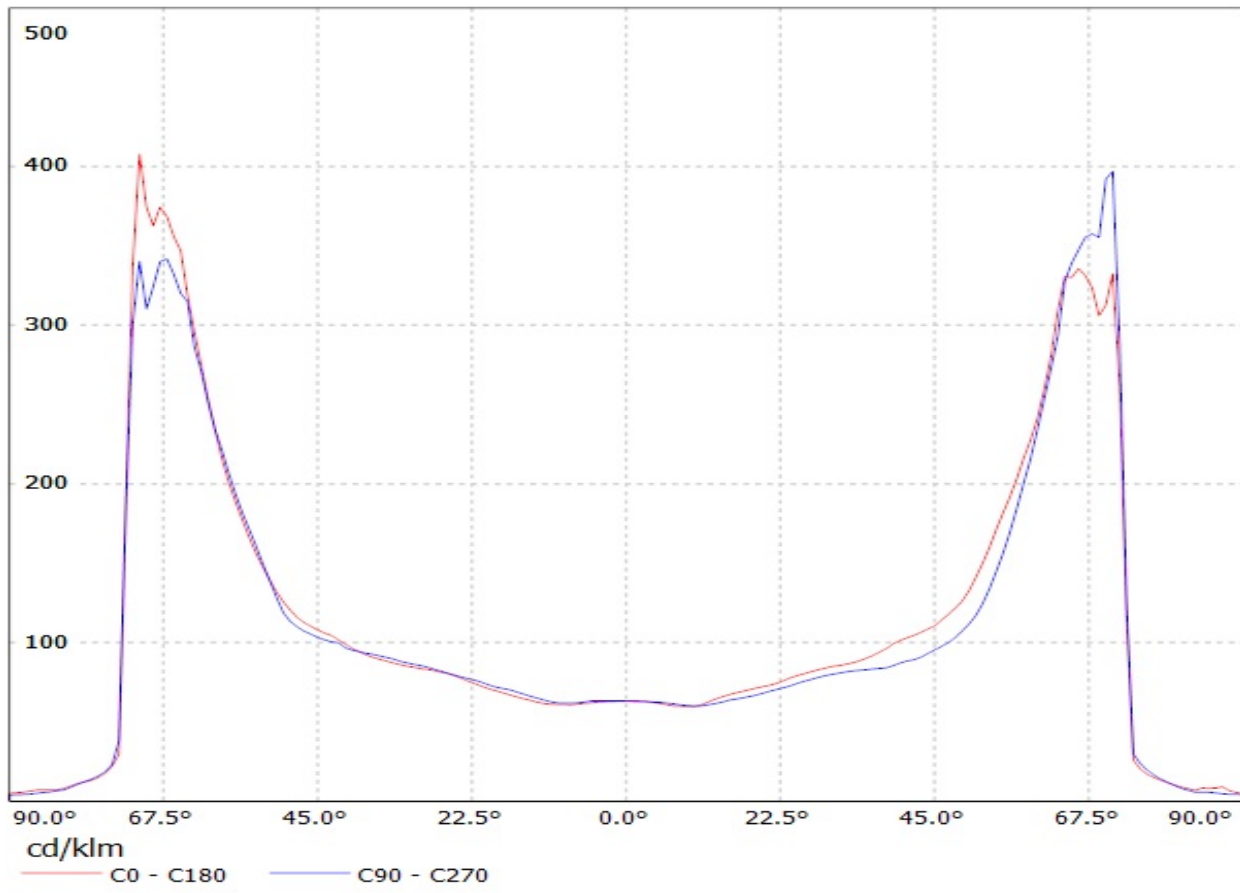

Luminaire: LEDiL Oy C12727_STRADA-SQ-VSM_(XP-L)
Lamps: 1 x Cree_XP-L_130.23lm@250mA_P=0.738255W_I=249.9mA

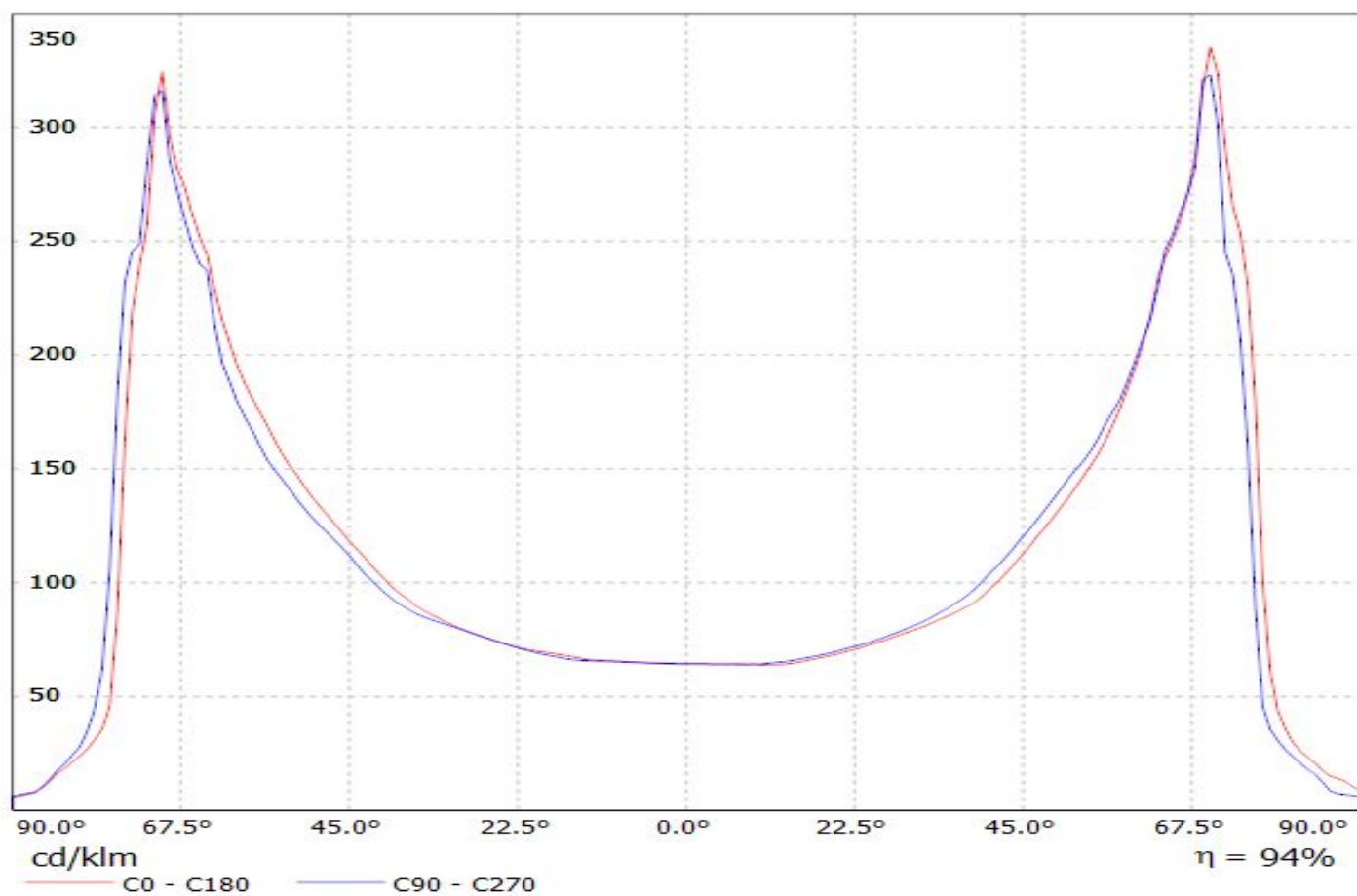

Luminaire: LEDiL Oy C12727_STRADA-SQ-VSM_(CREE_XHP50_COOL_WHITE)
Lamps: 1 x CREE_XHP50_COOL_WHITE_242.068lm@250mA_CCT=COOLWHITE_I=02499mA_P=1.42958

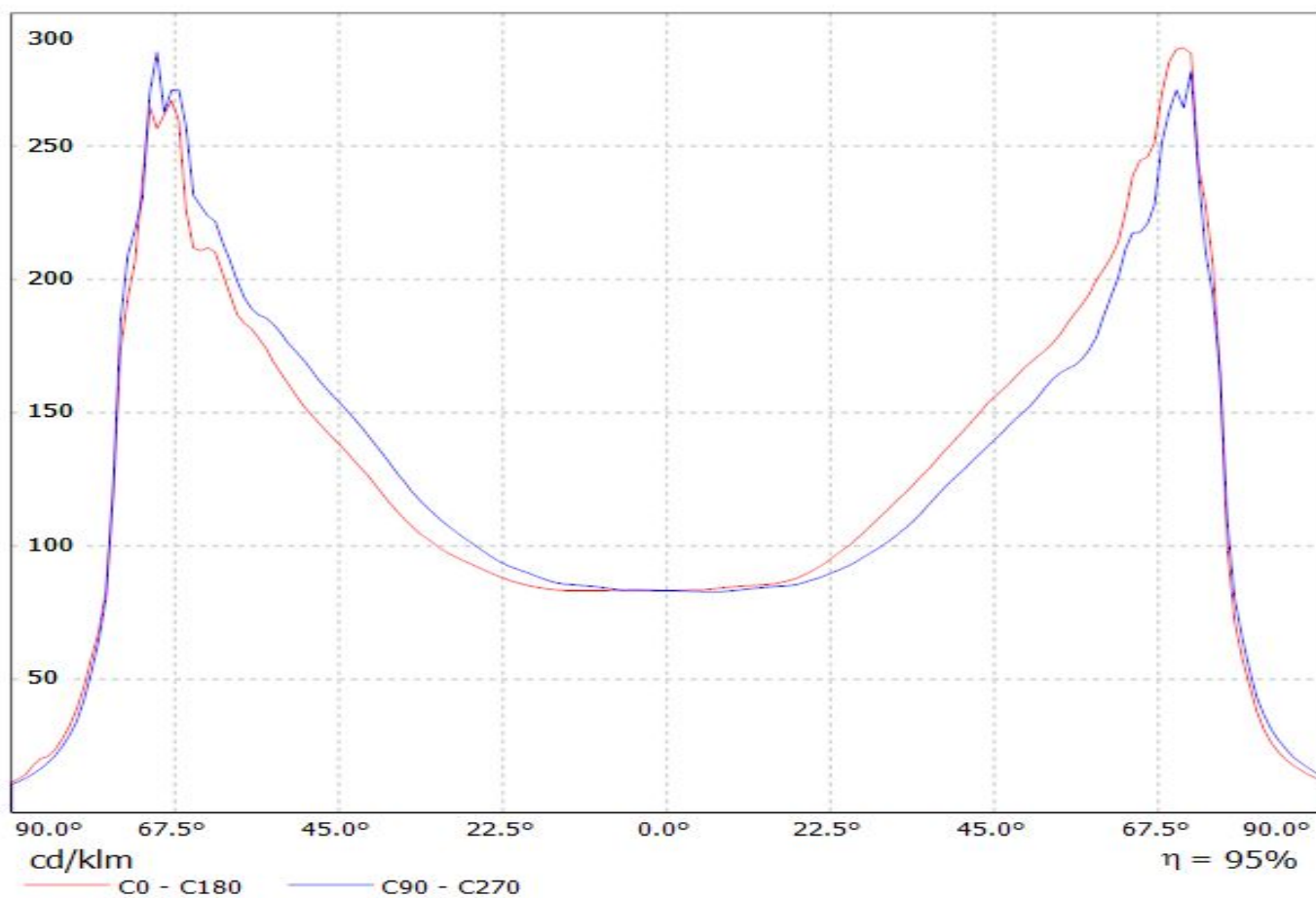

Luminaire: Ledil C12727_STRADA-SQ-VSM_(XP-L2)

Lamps: 1 x Cree_XP-L2_(XPLWT-00-0000-000HU630G)_115.868lm@250mA_P=0.717875W_η=0.25A

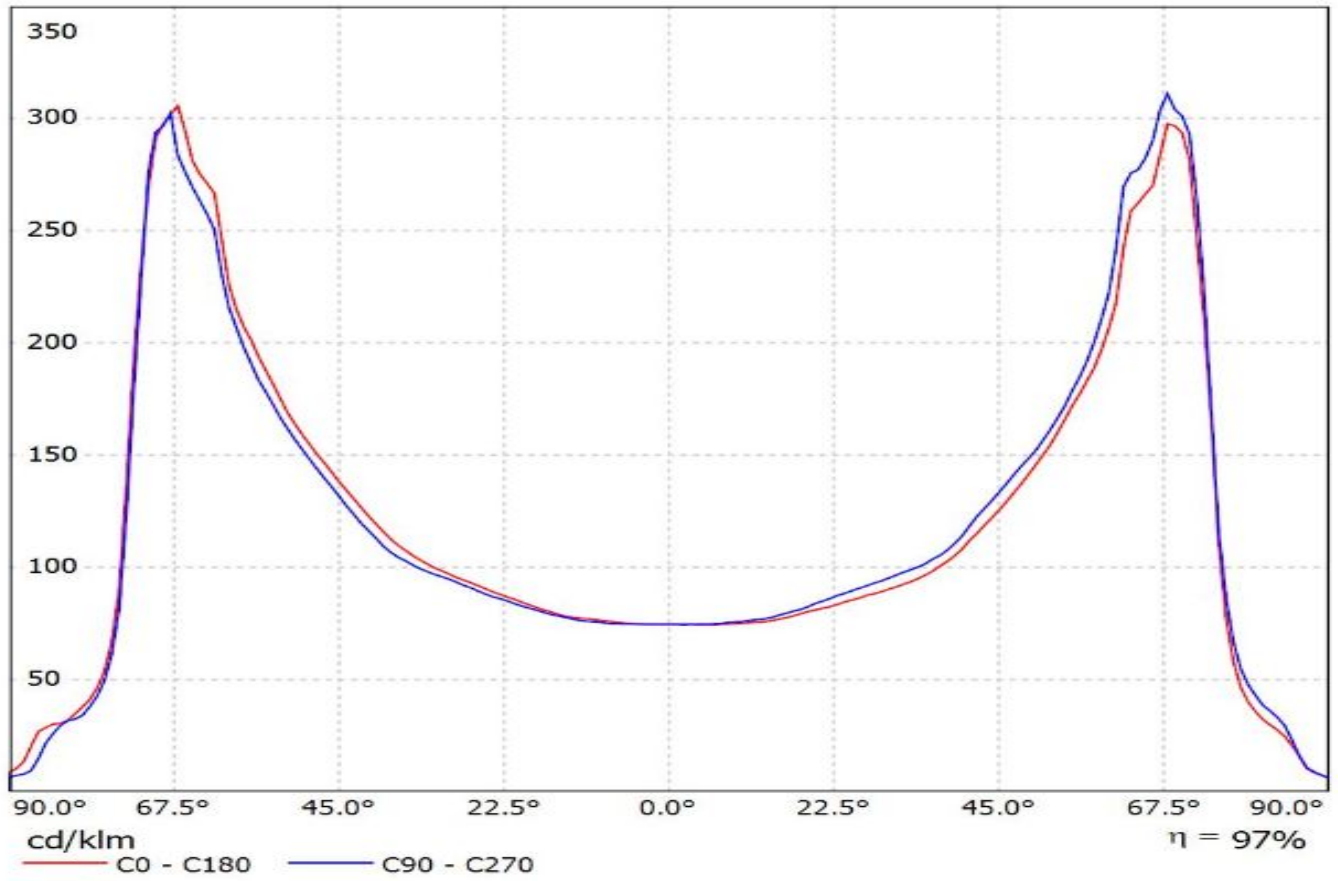

LEDiL Oy C12727_STRADA-SQ-VSM_(LG-3535-CERAMIC-GEN2) Eff.94.0% / LDC (Linear)

Luminaire: LEDiL Oy C12727_STRADA-SQ-VSM_(LG-3535-CERAMIC-GEN2) Eff.94.0%

Lamps: 1 x LG-3535-CERAMIC-GEN2_120.21lm@250mA_P=0.755298W_CCT=6235K_I=249.9mA

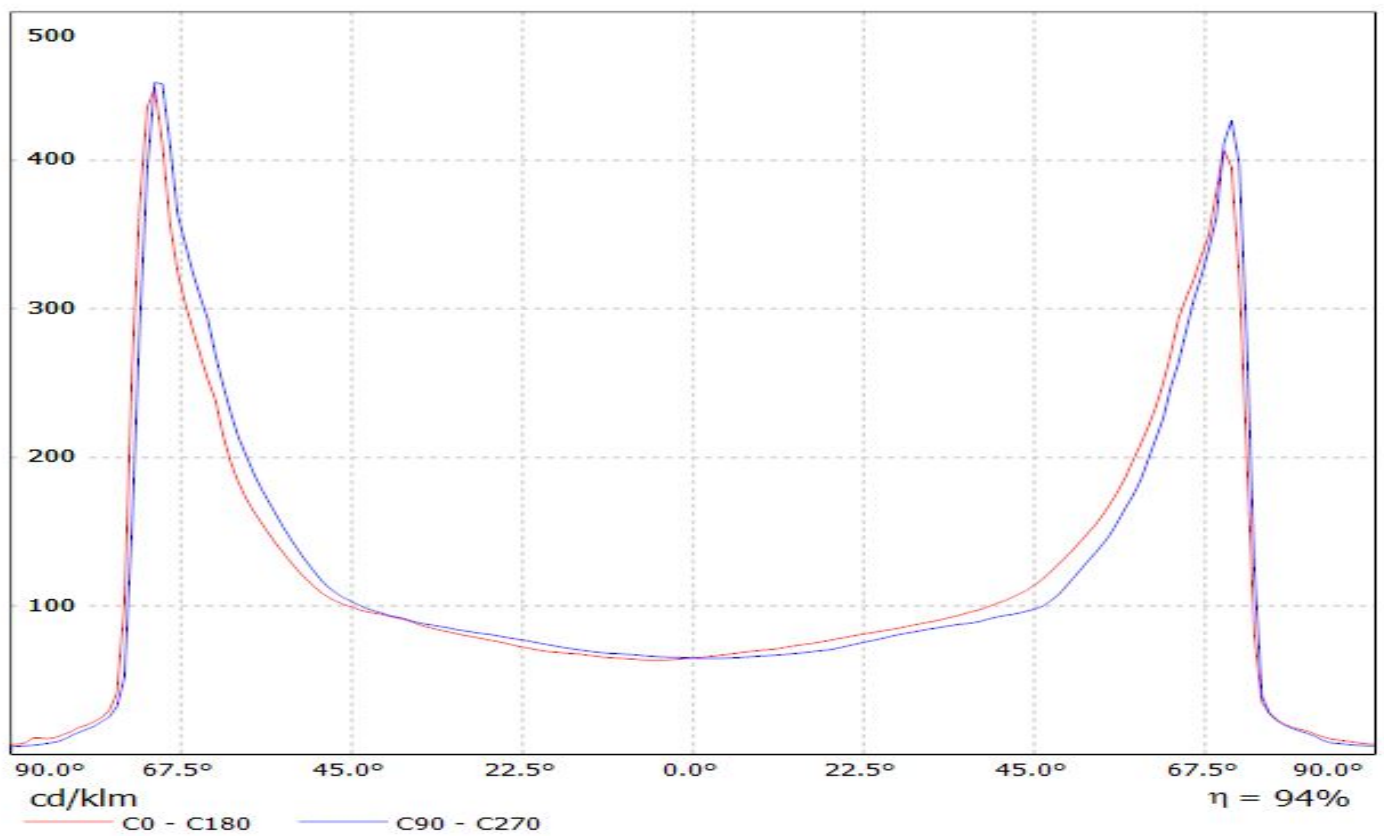

Luminaire: LEDIL OY C12727_STRADA-SQ-VSM (Luxeon M) Efficiency=95%
Lamps: 1 x Luxeon M (360lm@250mA)

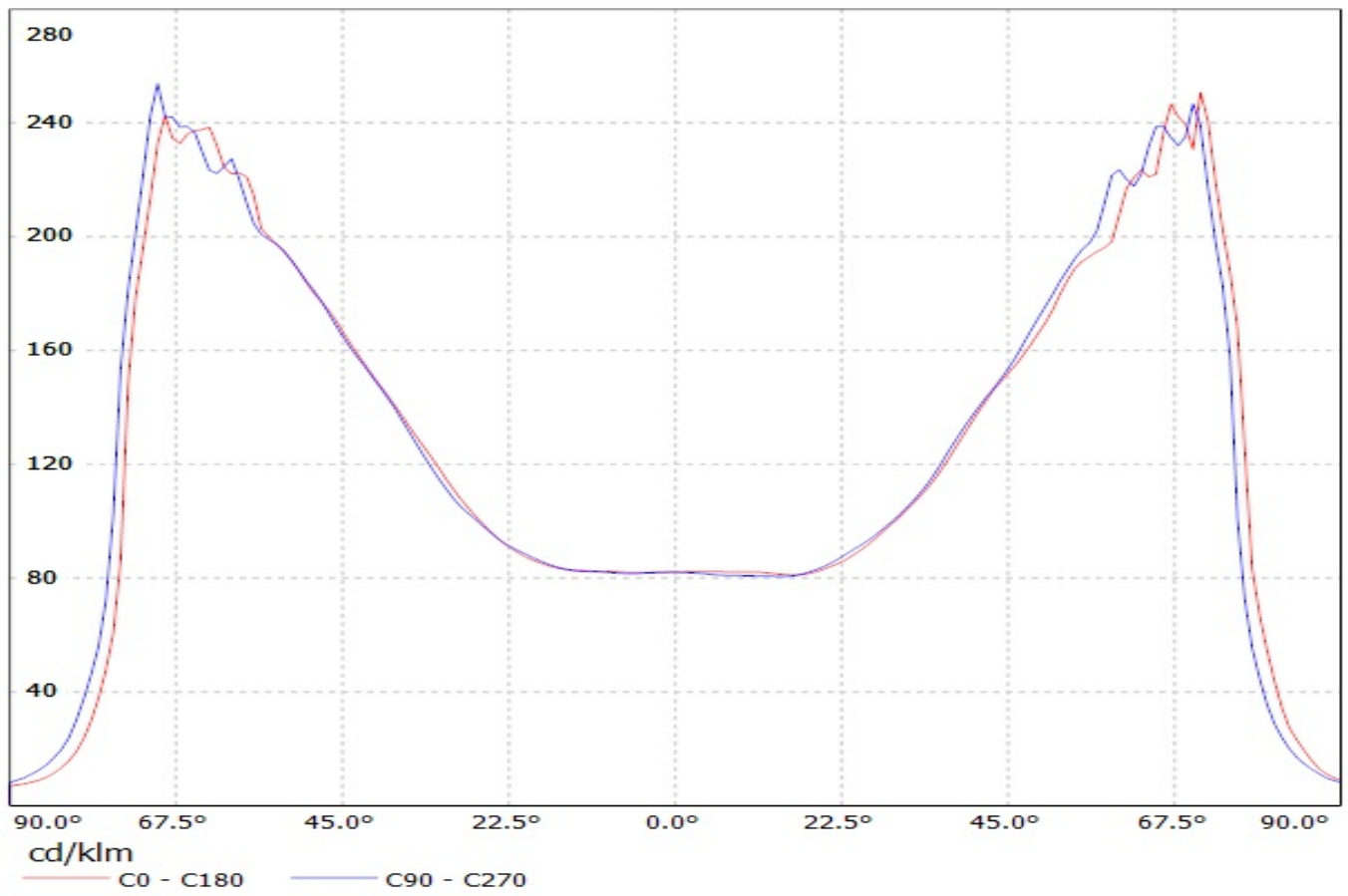

Luminaire: LEDil Oy C12727_STRADA-SQ-VSM_(Luxeon_MZ) Efficiency=94%
Lamps: 1 x Philips Lumileds Luxeon MZ (389lm @ 250mA) CCT=3800K P=2.8W I=250mA

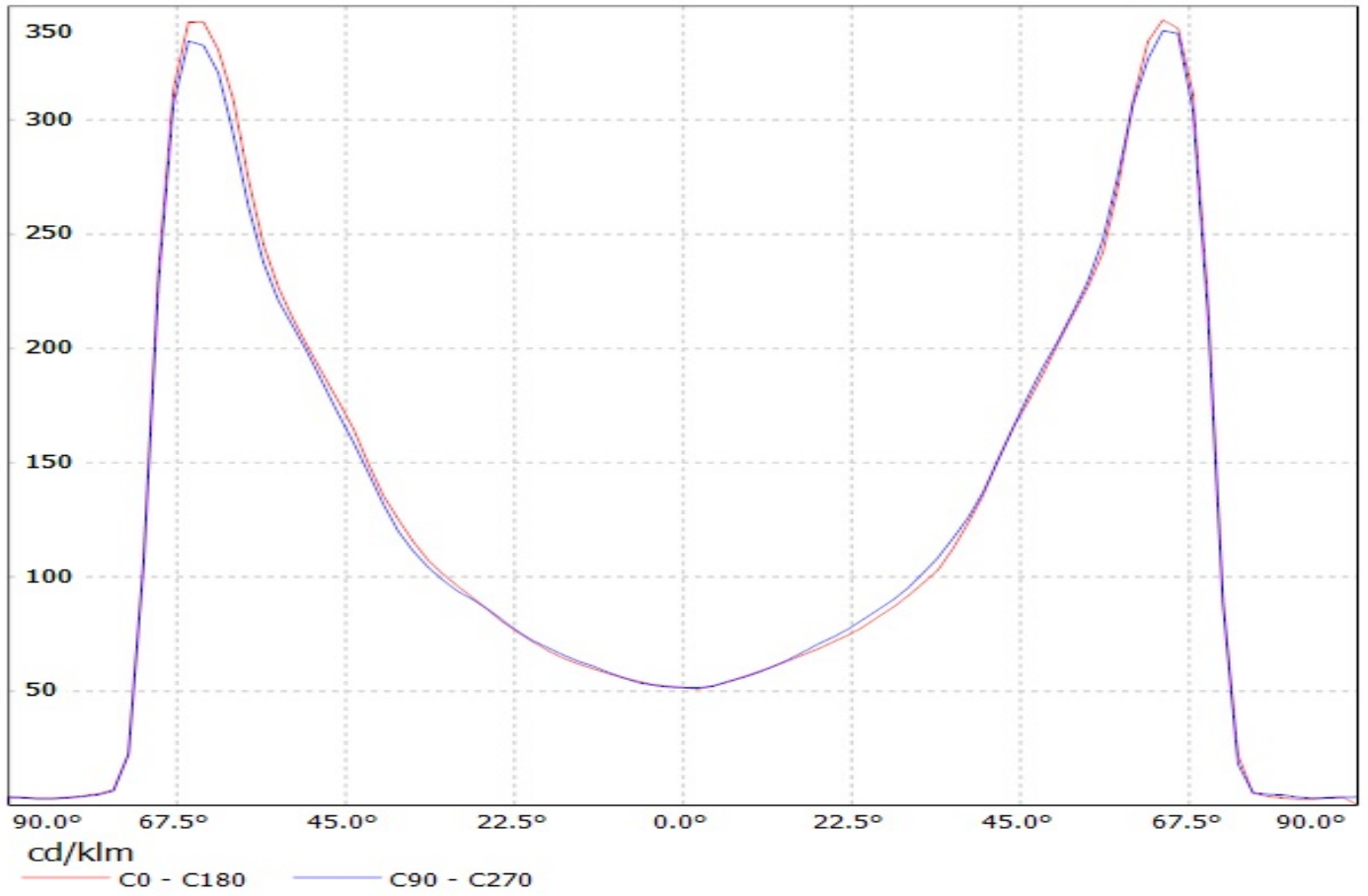

Luminaire: LEDiL Oy C12727_STRADA-SQ-VSM_(NFMx48xAR)

Lamps: 1 x Nichia_NFMx48xAR_(NFMW488AR)_574.333lm@100mA_P=4.0048W_I=0.100A

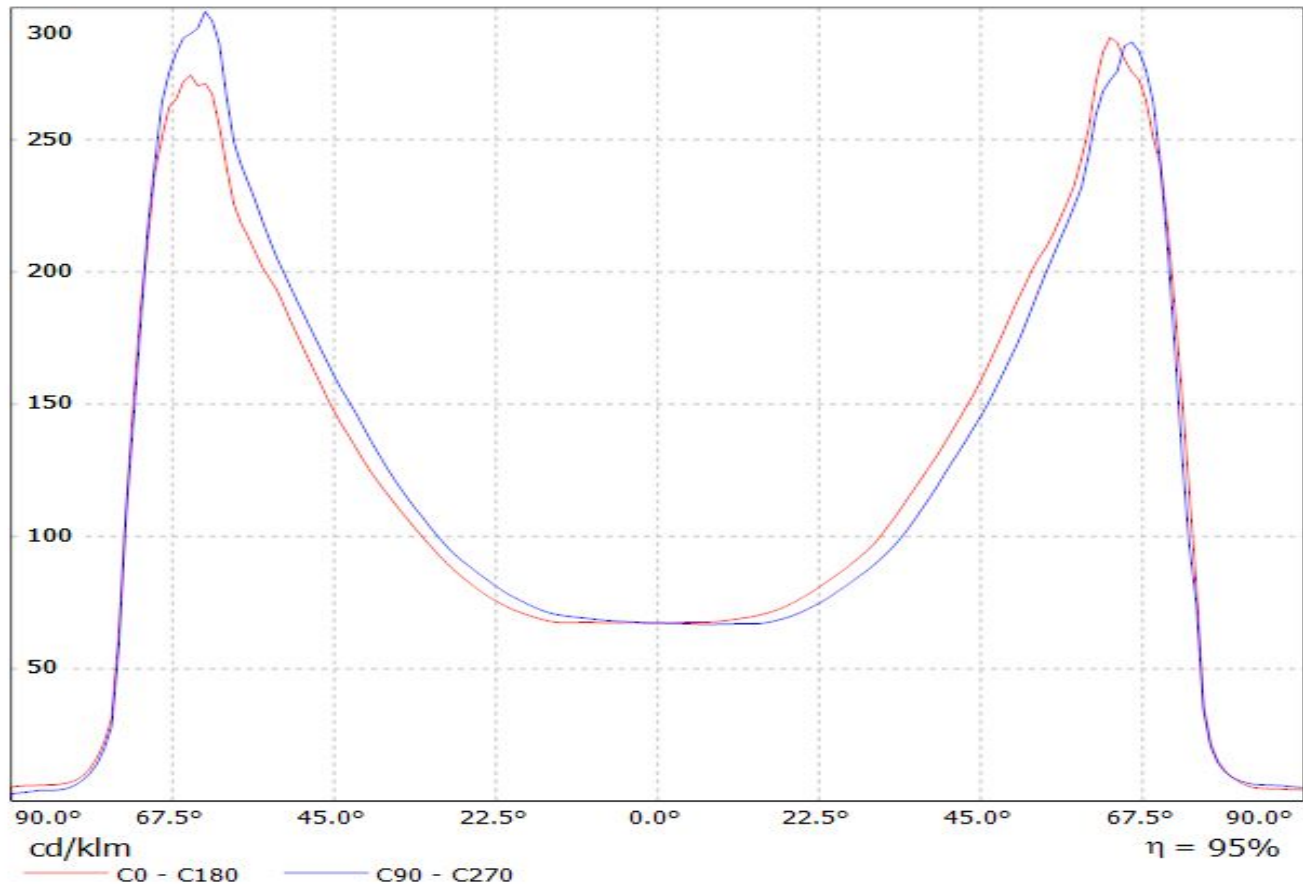

Luminaire: LEDiL Oy C12727_STRADA-SQ-VSM_(XM-L) Eff.93%
Lamps: 1 x CREE_XM-L_78.0576lm@250mA_P=0.71104W_I=249.9mA

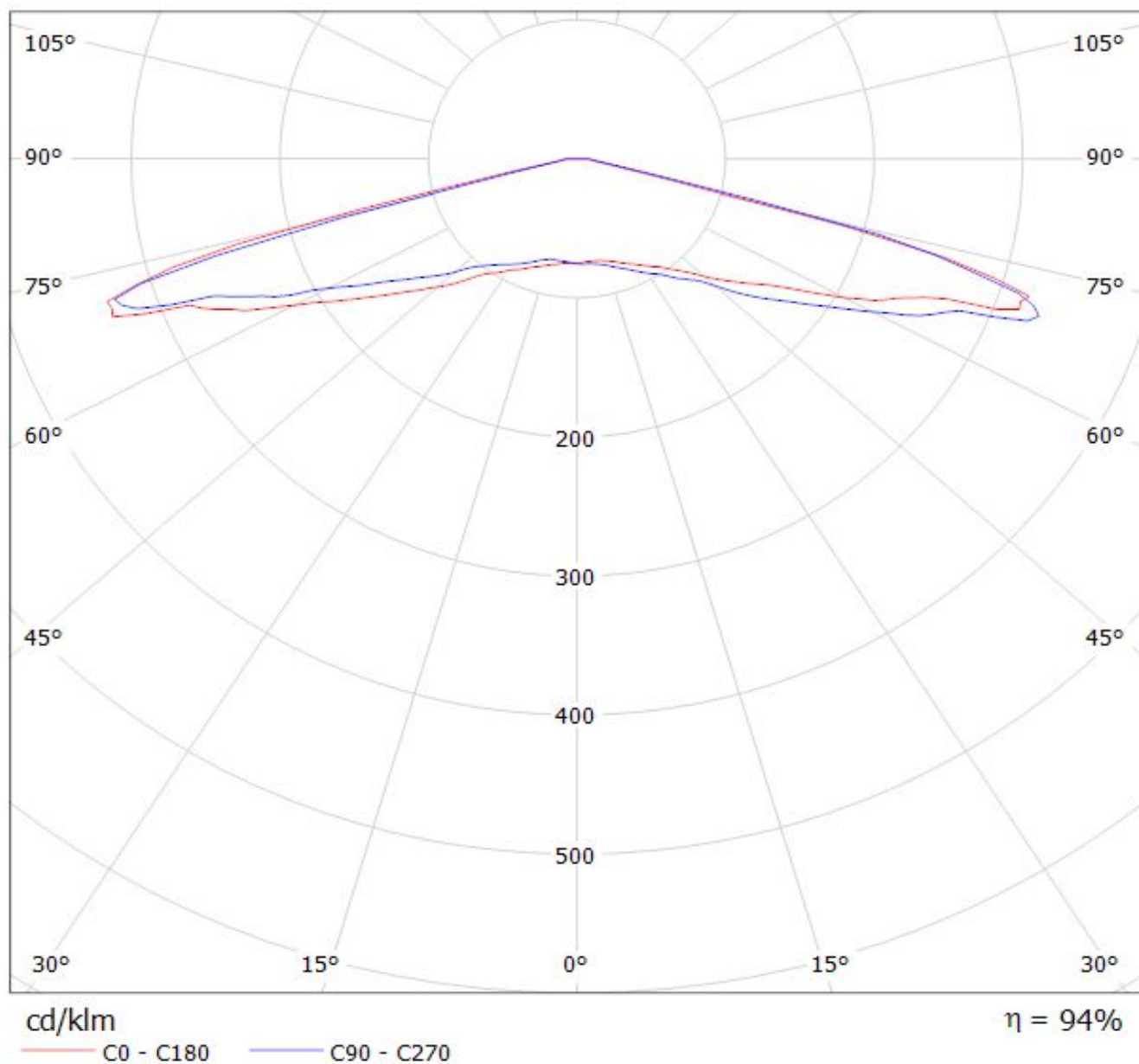

Luminaire: LEDiL Oy C12727_STRADA-SQ-VSM_(XT-E) Eff. 93%
Lamps: 1 x Cree XT-E 100lm @ 250mA

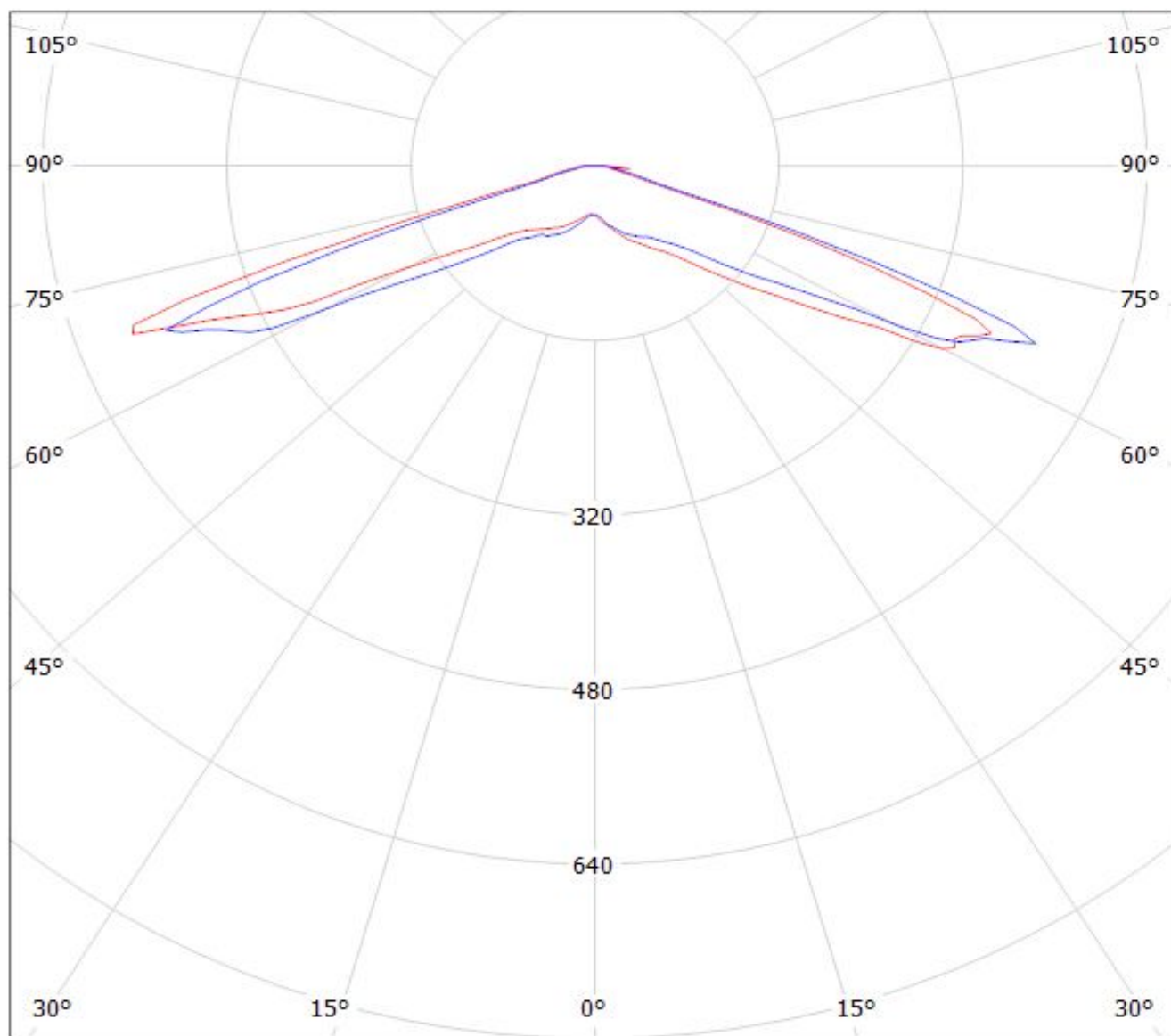

cd/klm

— C0 - C180 — C90 - C270

$\eta = 95\%$

Valaisin: LEDIL OY C12727_STRADA-SQ-VSM (XP-G2) Efficiency=95%
Lamput: 1 x Cree XP-G2 (109.1lm @ 250mA)

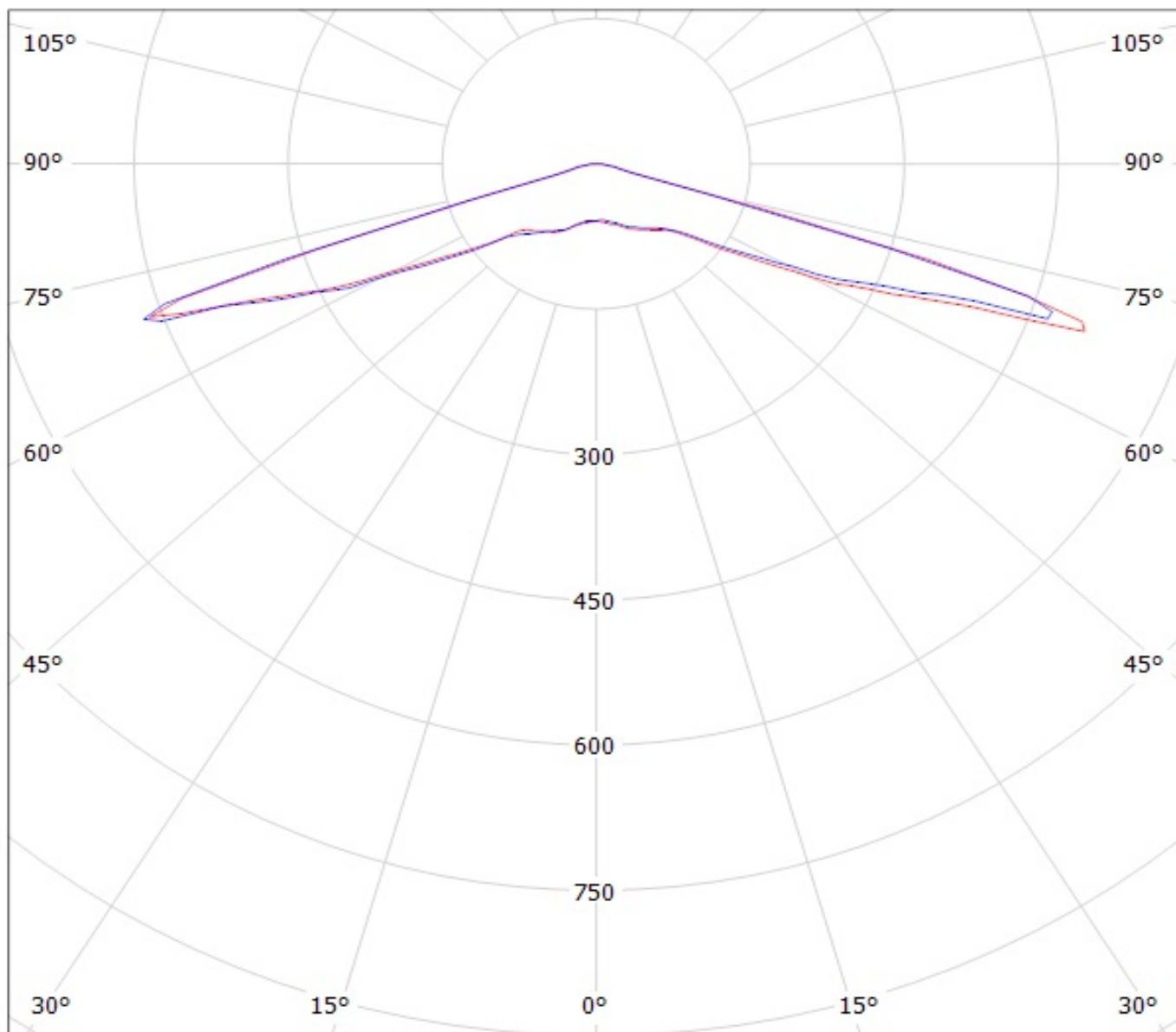

cd/klm

— C0 - C180 — C90 - C270

Luminaire: LEDil Oy C12727_STRADA-SQ-VSM_(XM-L2) Efficiency=94%

Lamps: 1 x Cree XM-L2 (XMLBWT-0-7B4-T30-0L-0001) 91lm @ 250mA CCT=3200K P=0.7W I=250mA

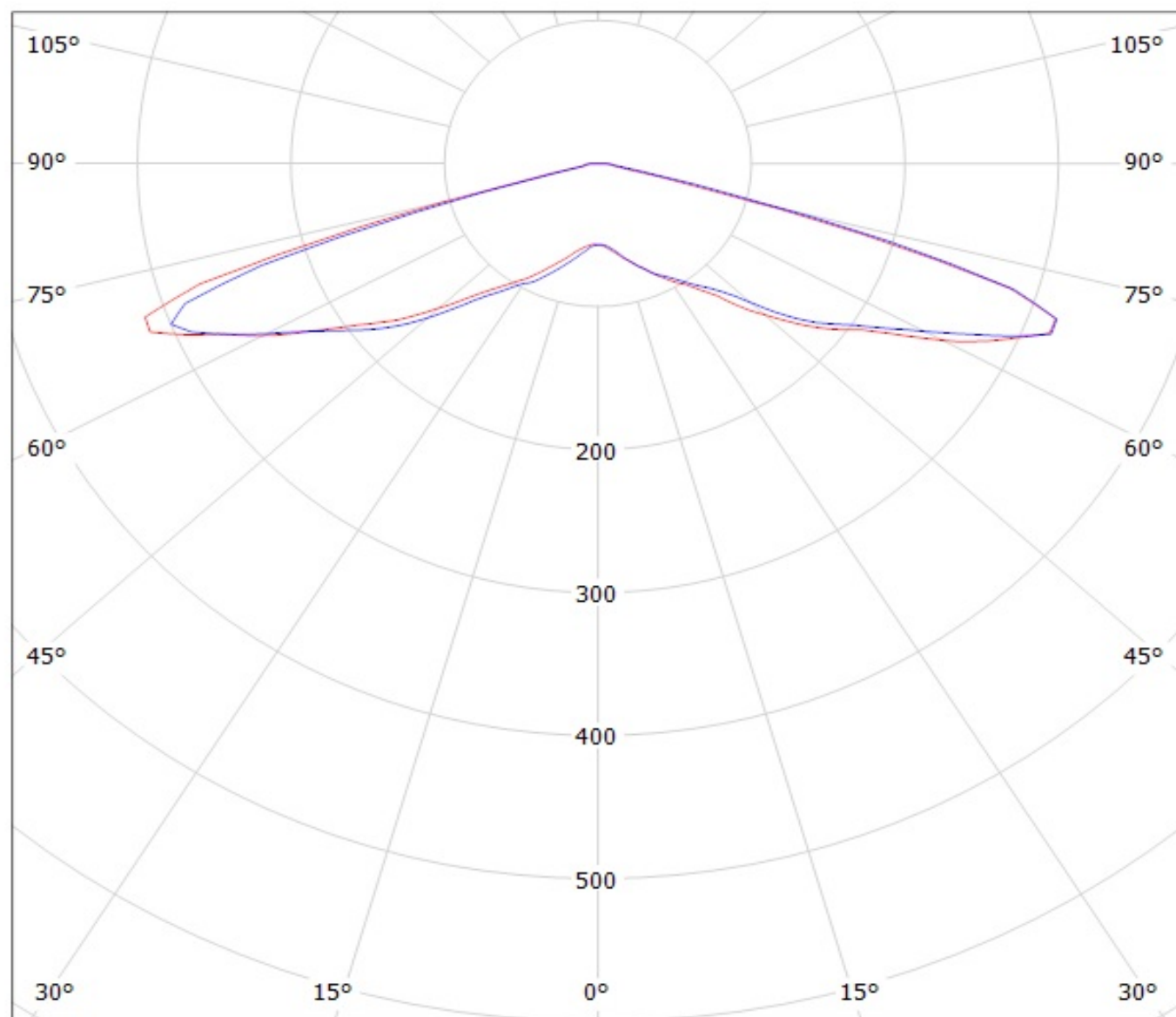

cd/klm

— C0 - C180 — C90 - C270

Luminaire: LEDiL Oy C12727_STRADA-SQ-VSM_(XP-E2) Eff. 94%

Lamps: 1 x CREE_XP-E2_(XPEBWT-L1-7B4-Q4-0-01)_82.2649lm@250mA_P=0.753923W_CCT=3194K_I=249.9mA

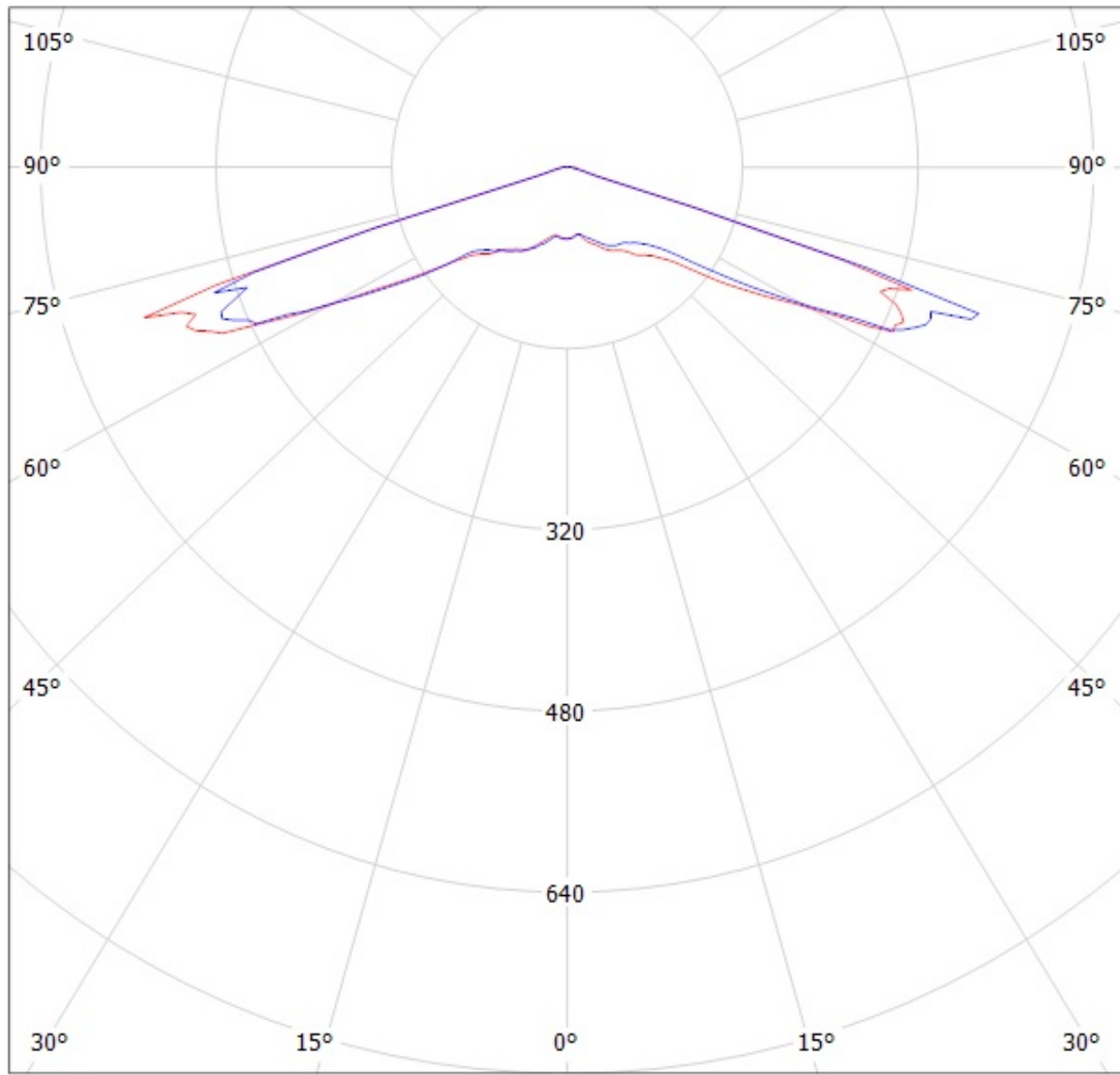

cd/klm

— C0 - C180 — C90 - C270

Luminaire: LEDiL Oy C12727_STRADA-SQ-VSM_(XP-L)
Lamps: 1 x Cree_XP-L_130.23lm@250mA_P=0.738255W_I=249.9mA

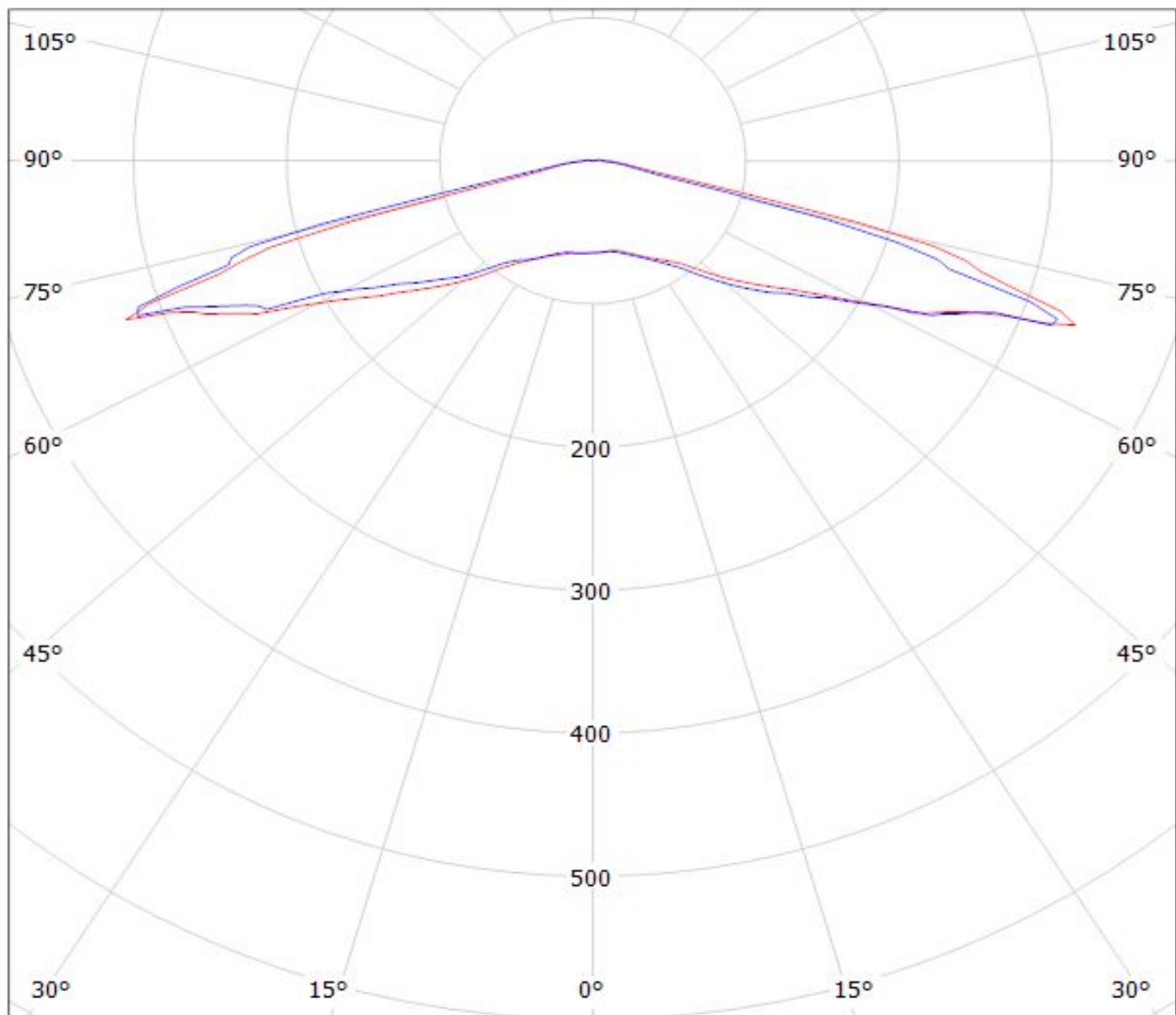

cd/klm

$\eta = 94\%$

— C0 - C180

— C90 - C270

Luminaire: LEDiL Oy C12727_STRADA-SQ-VSM_(CREE_XHP50_COOL_WHITE)

Lamps: 1 x CREE_XHP50_COOL_WHITE_242.068lm@250mA_CCT=COOLWHITE_I=02499mA_P=1.42958

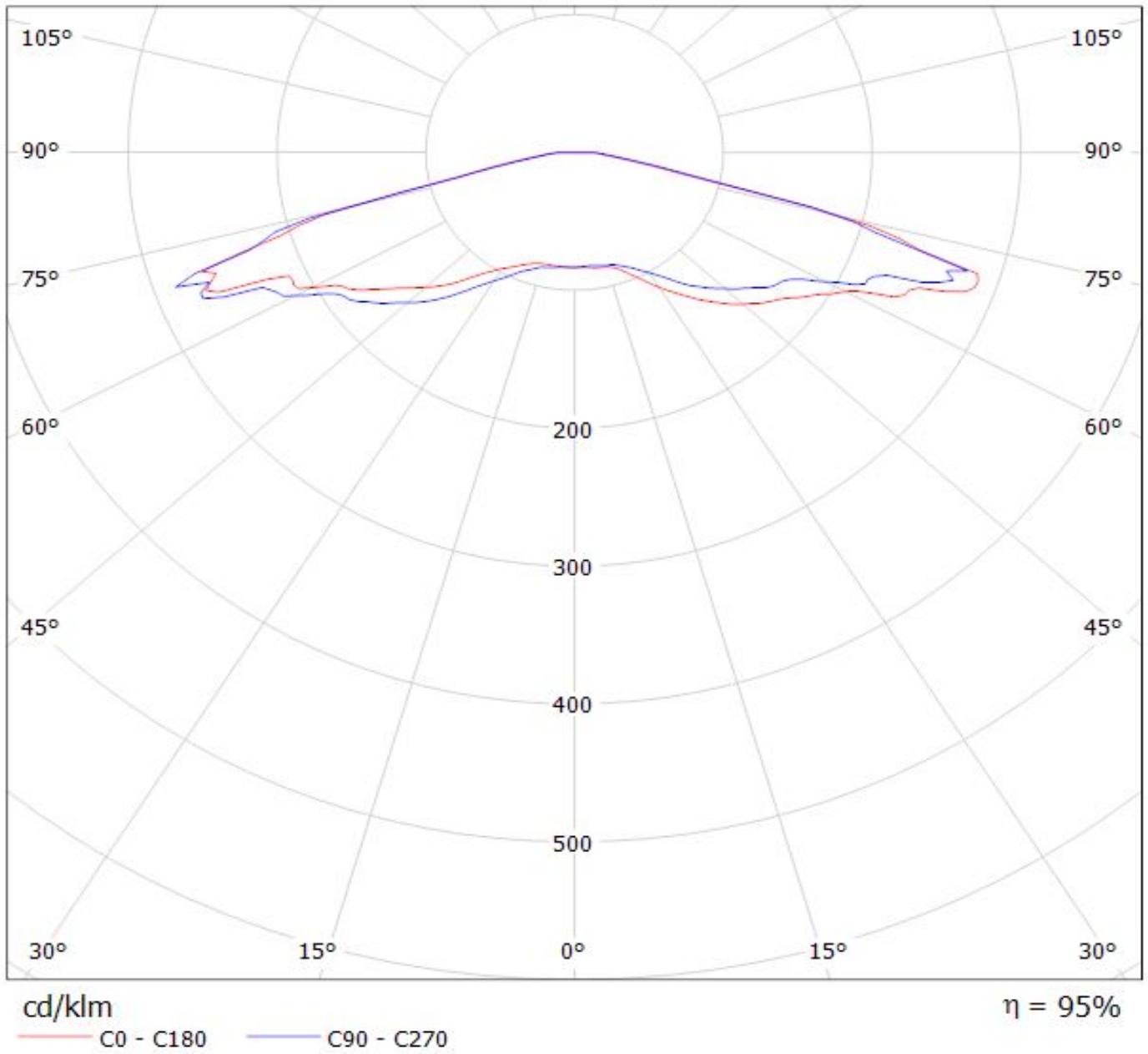

Luminaire: Ledil C12727_STRADA-SQ-VSM_(XP-L2)

Lamps: 1 x Cree_XP-L2_(XPLWT-00-0000-000HU630G)_115.868lm@250mA_P=0.717875W_I=0.25A

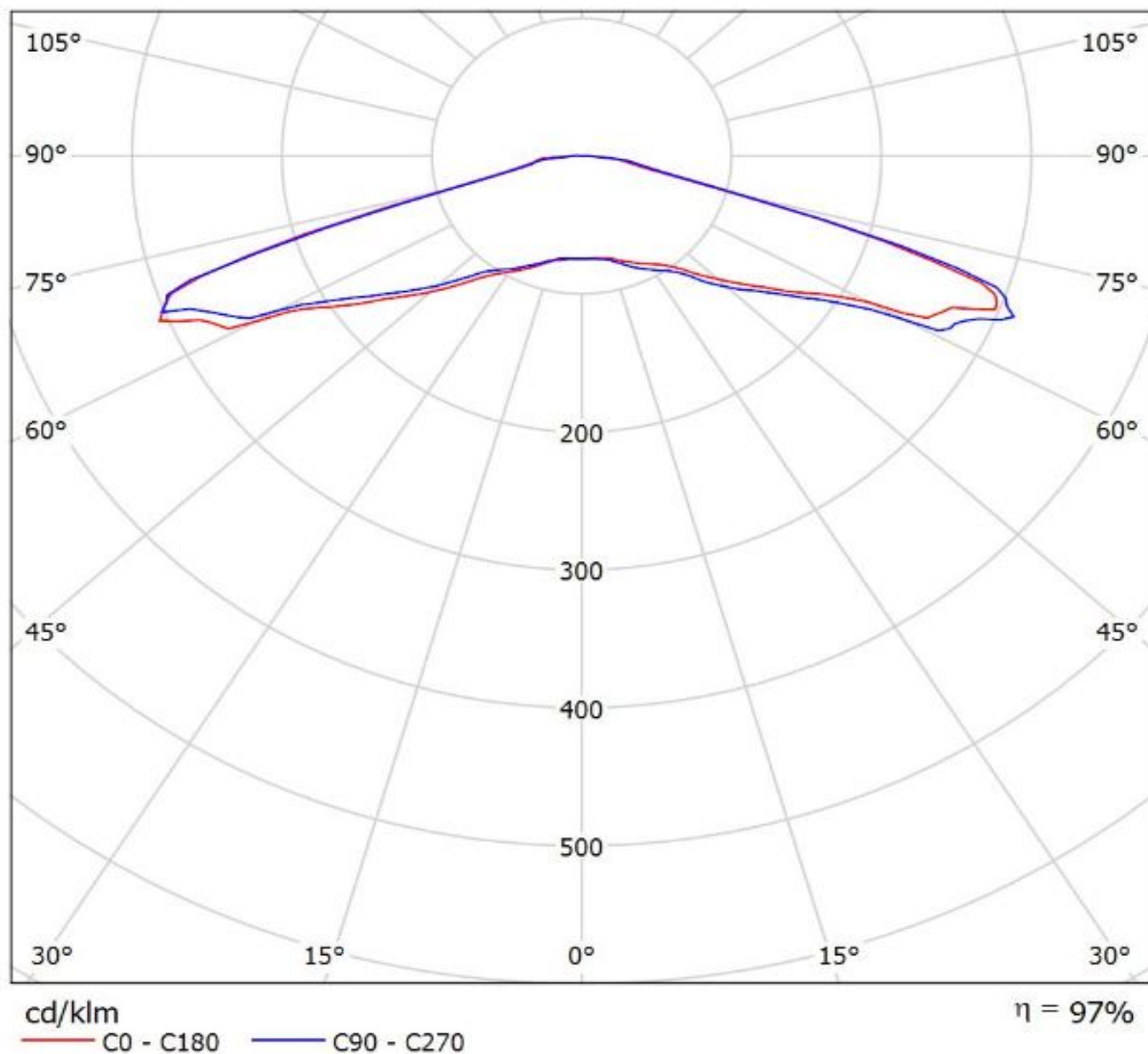

**LEDiL Oy C12727_STRADA-SQ-VSM_(LG-3535-CERAMIC-GEN2) Eff.94.0% /
LDC (Polar)**

Luminaire: LEDiL Oy C12727_STRADA-SQ-VSM_(LG-3535-CERAMIC-GEN2) Eff.94.0%
Lamps: 1 x LG-3535-CERAMIC-GEN2_120.21lm@250mA_P=0.755298W_CCT=6235K_I=249.9mA

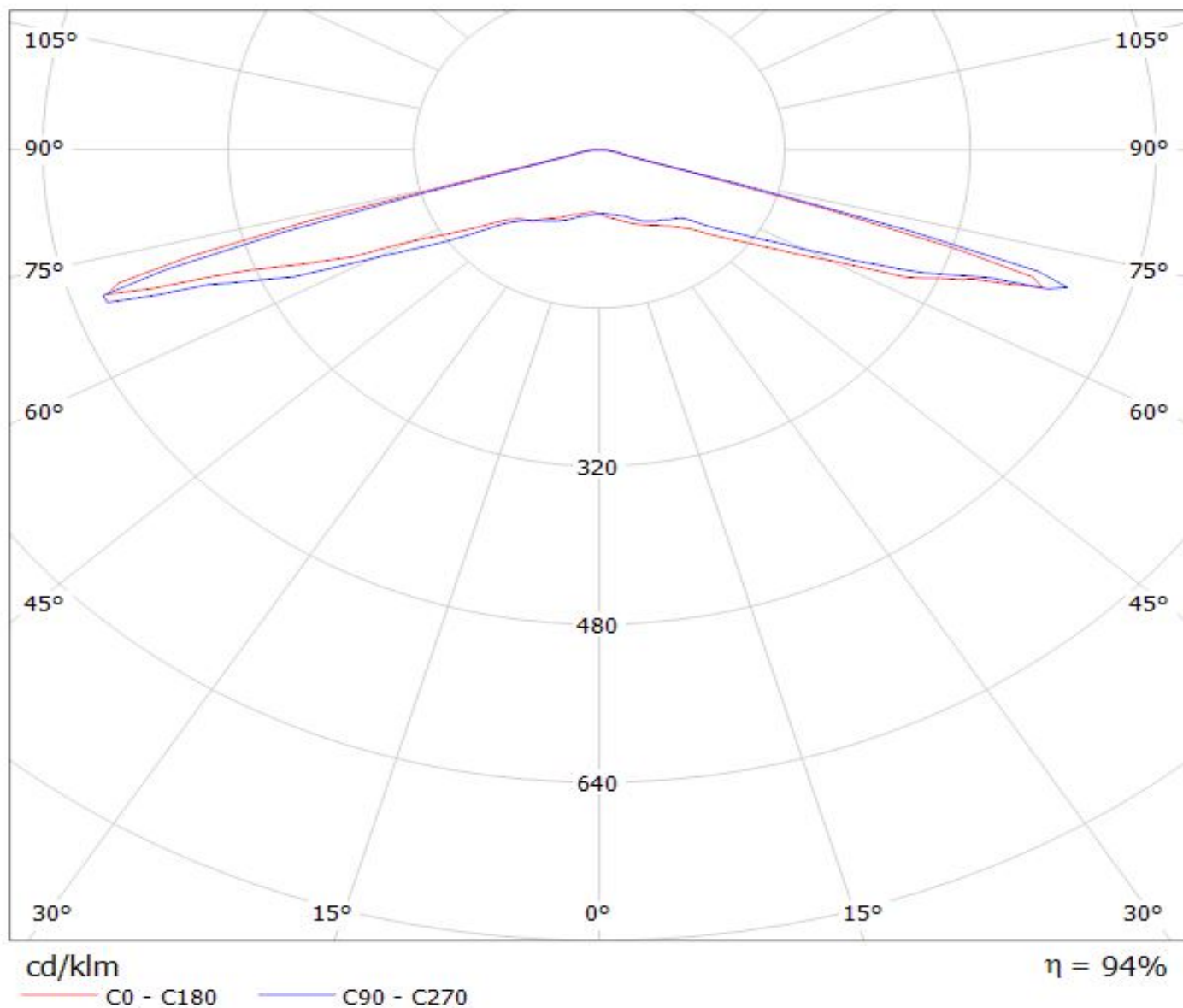

Luminaire: LEDIL OY C12727_STRADA-SQ-VSM (Luxeon M) Efficiency=95%
Lamps: 1 x Luxeon M (360lm@250mA)

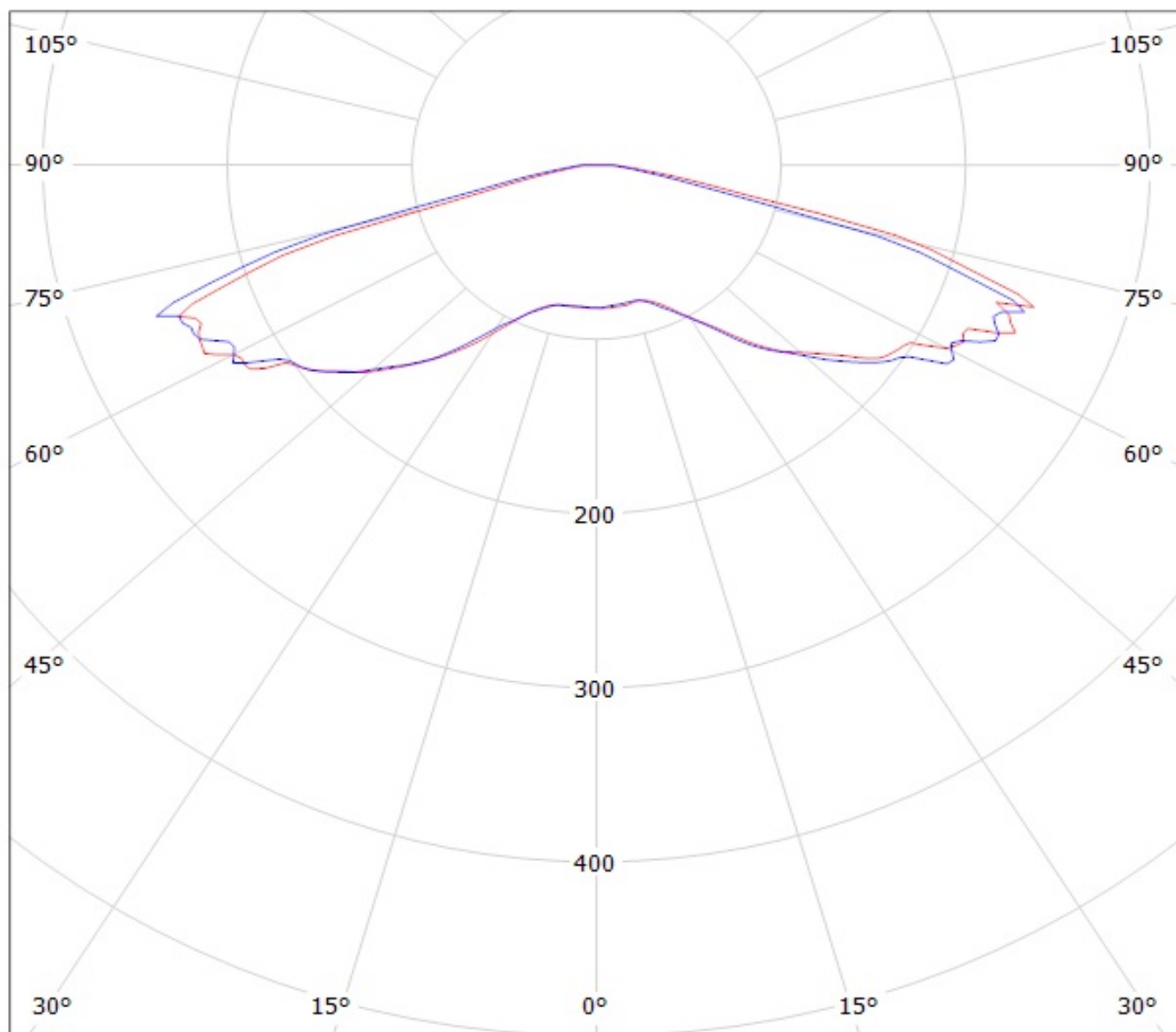

cd/klm

— C0 - C180

— C90 - C270

Luminaire: LEDil Oy C12727_STRADA-SQ-VSM_(Luxeon_MZ) Efficiency=94%
Lamps: 1 x Philips Lumileds Luxeon MZ (389lm @ 250mA) CCT=3800K P=2.8W I=250mA

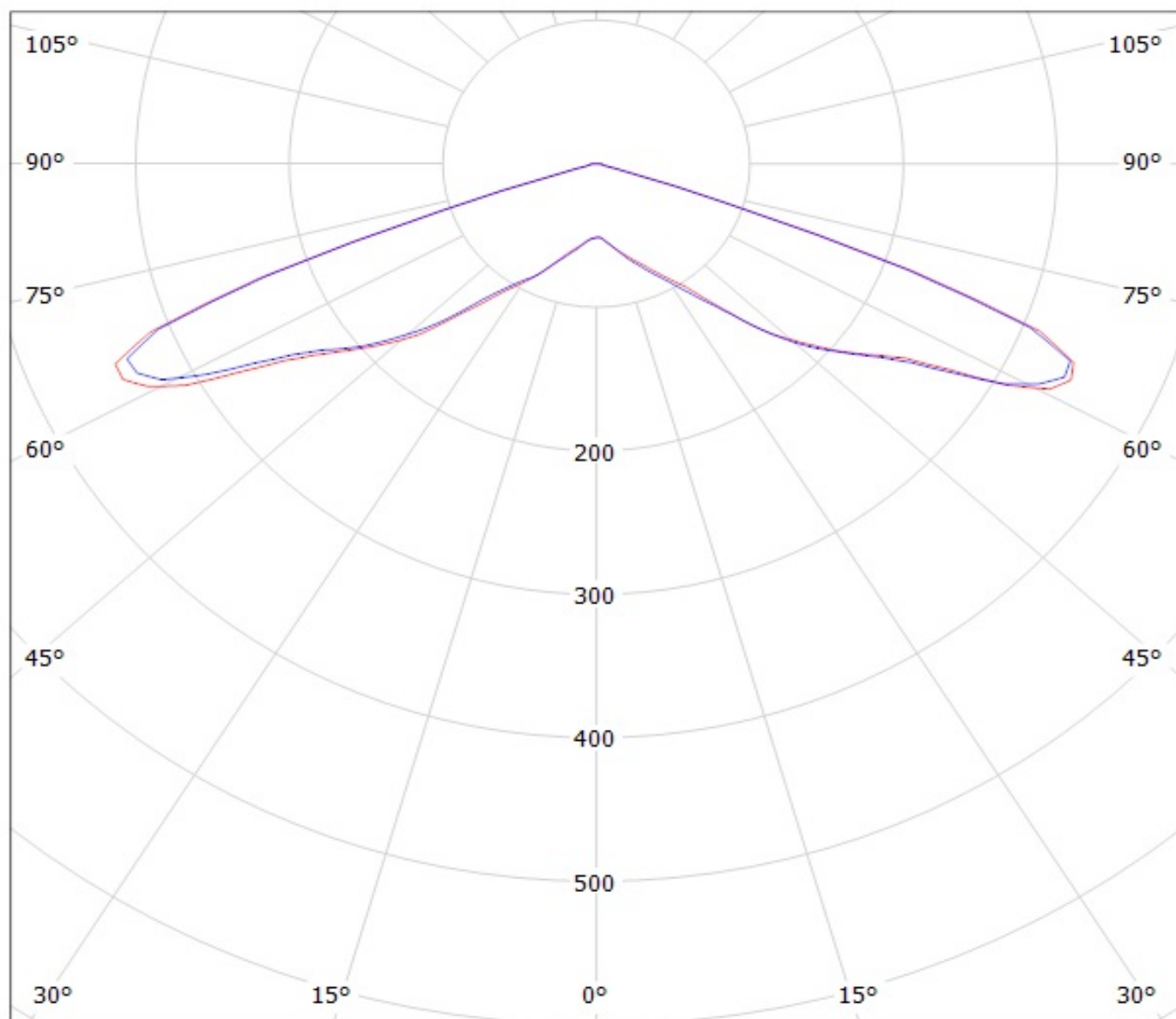

cd/klm

— C0 - C180 — C90 - C270

Luminaire: LEDiL Oy C12727_STRADA-SQ-VSM_(NFMx48xAR)

Lamps: 1 x Nichia_NFMx48xAR_(NFMW488AR)_574.333lm@100mA_P=4.0048W_I=0.100A

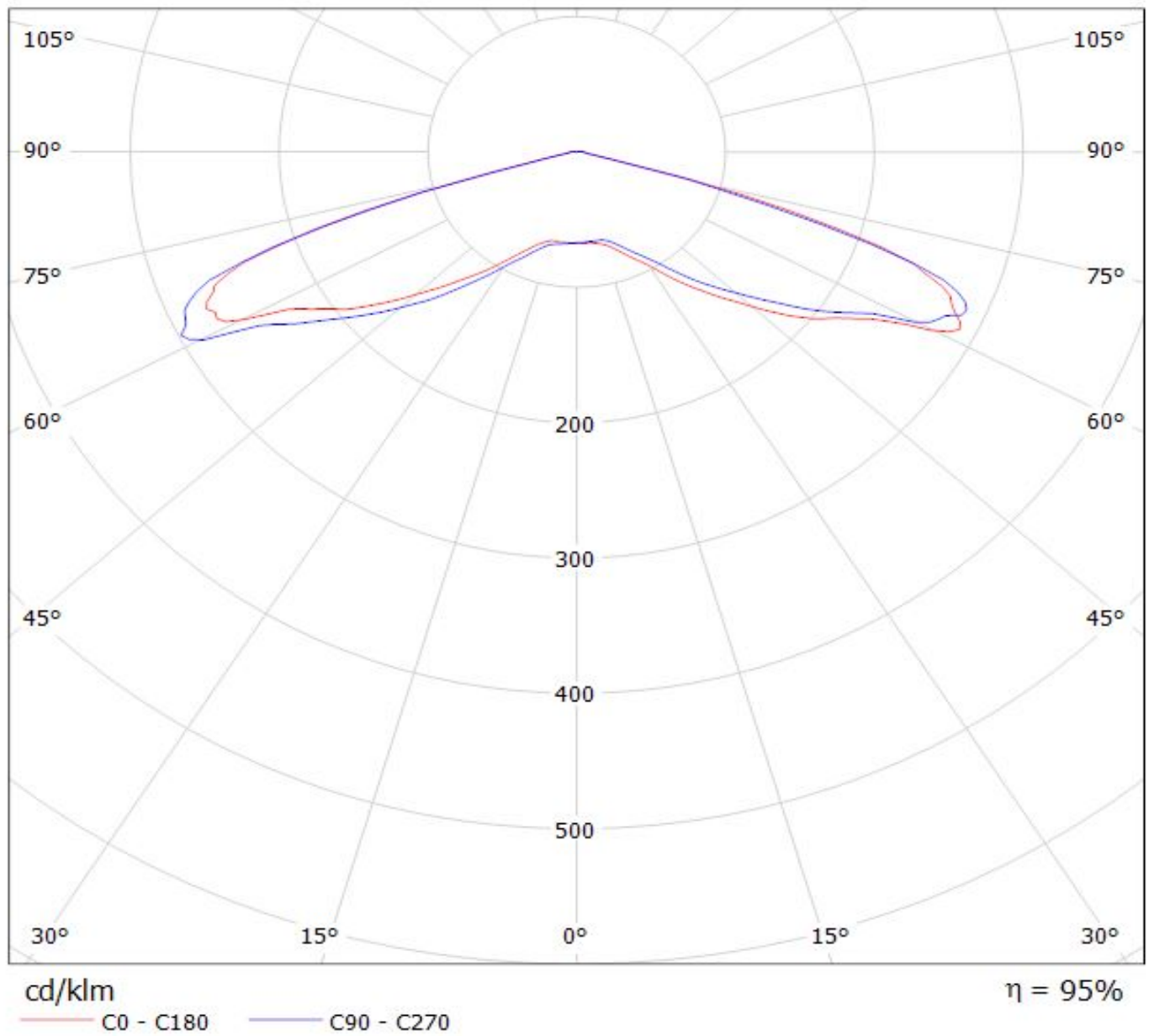

NOTE: The typical divergence will be changed by different color, chip size and chip position tolerance. The typical total divergence is the full angle measured where the luminous intensity is half of the peak value.