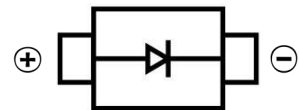

**GENERAL PURPOSE RECTIFIER DIODE**
**FEATURES**

- Diffused junction
- Low reverse leakage current
- Low forward voltage drop
- High current capability
- Surface Mount device

**SMA**

**MECHANICAL DATA**

- Case: SMA(DO-214AC)
- Case Material: Molded Plastic. UL flammability
- Classification Rating: 94V-0
- Weight: 0.065 grams (approximate)

**MAXIMUM RATINGS AND CHARACTERISTICS(T<sub>A</sub> = 25°C unless otherwise noted)**

Parameter	Symbol	Value	Unit
Maximum Recurrent Peak Reverse Voltage	V <sub>RRM</sub>	1000	V
DC Blocking Reverse Voltage	V <sub>R</sub>	1000	V
RMS Reverse Voltage	V <sub>R(RMS)</sub>	700	V
Maximum Average Forward Rectified Current	I <sub>F</sub>	1	A
Non-Repetitive Peak Forward Surge Current @t@=8.3ms	I <sub>FSM</sub>	30	A
Thermal Resistance From Junction To Ambient	R <sub>θJA</sub>	30	°C/W
Junction Temperature	T <sub>J</sub>	125	°C
Storage Temperature	T <sub>STG</sub>	-55 ~+150	°C

**ELECTRICAL CHARACTERISTICS (T<sub>A</sub> = 25°C unless otherwise specified)**

Parameter	Symbol	Min	Typ	Max	Unit	Conditions
Forward voltage	V <sub>F</sub>			1.1	V	I <sub>F</sub> =1A
Reverse current	I <sub>R</sub>			5	uA	V <sub>R</sub> =1000V
Diode capacitance	C <sub>D</sub>		10		pF	V <sub>R</sub> =4V,f=1MHz

GENERAL PURPOSE RECTIFIER DIODE

Typical Characteristics

FIG.1: FORWARD CURRENT DERATING CURVE

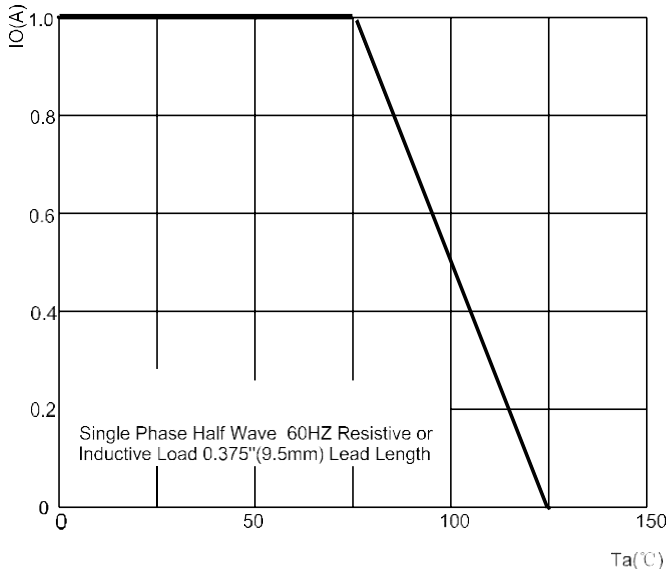

FIG.2: MAXIMUM NON-REPETITIVE FORWARD SURGE CURRENT

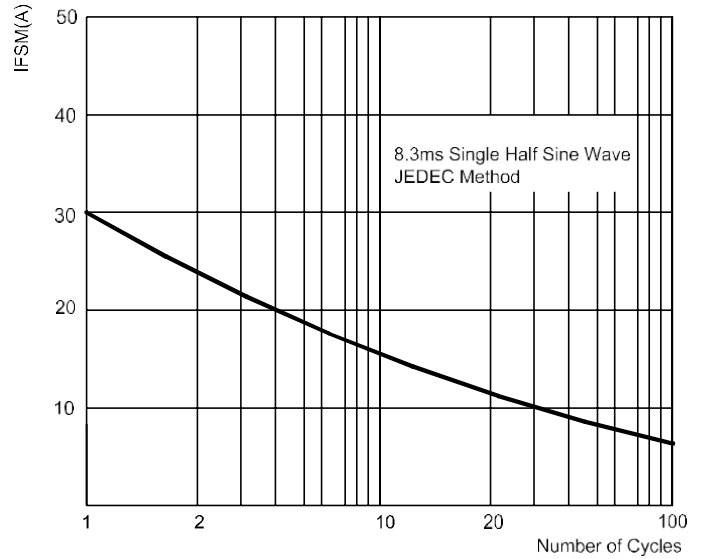

FIG.3: TYPICAL FORWARD CHARACTERISTICS

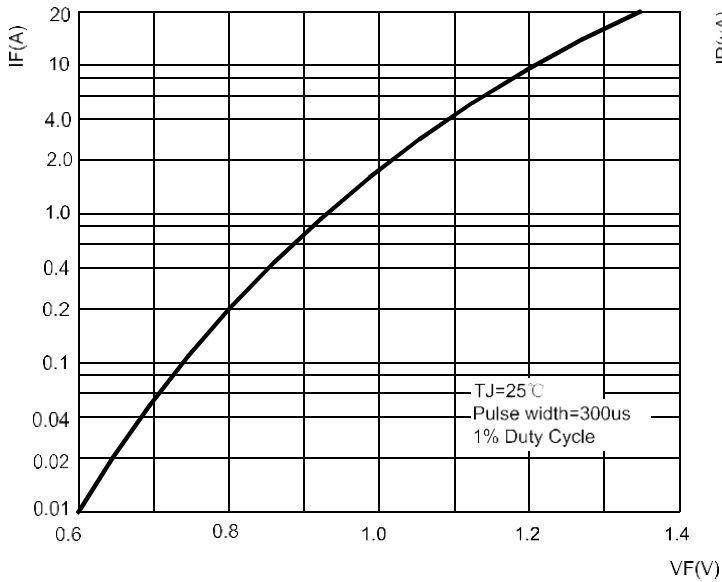
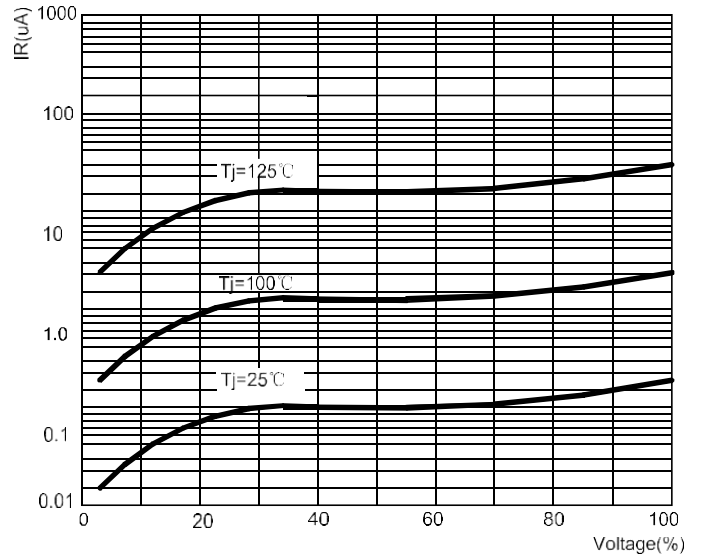
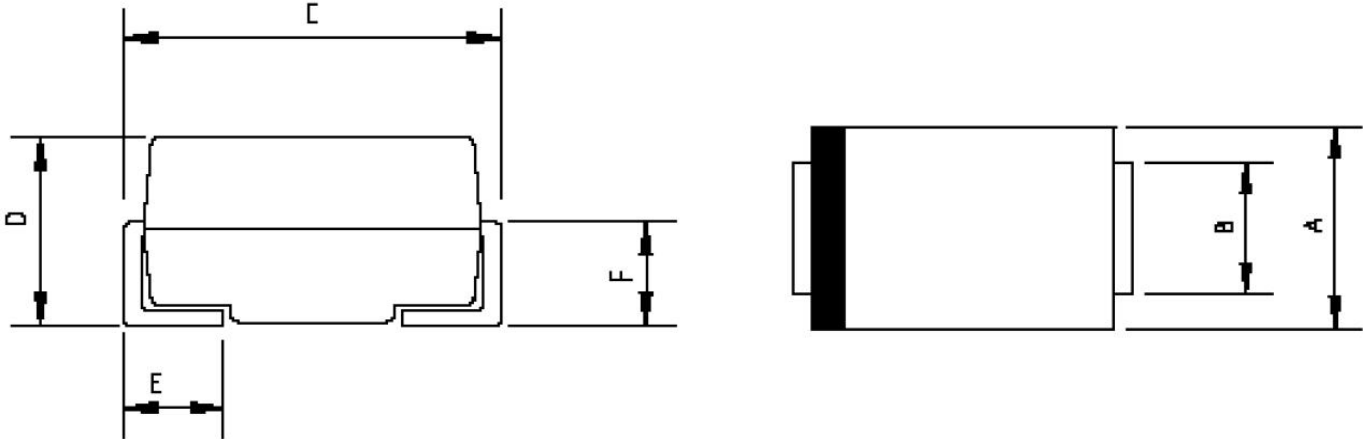
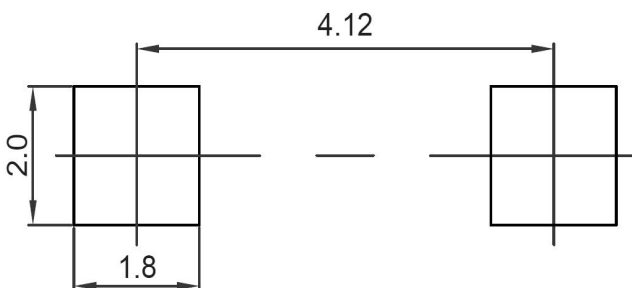

FIG.4: TYPICAL REVERSE CHARACTERISTICS



**GENERAL PURPOSE RECTIFIER DIODE**
**SMA Package Outline Dimensions**

Symbol	Dimensions In Millimeters		Dimensions In Inches	
	Min.	Max.	Min.	Max.
A	2.20	2.80	0.086	0.110
B	1.30	1.70	0.051	0.067
C	4.70	5.30	0.185	0.209
D	1.70	2.55	0.067	0.100
E	0.90	1.50	0.035	0.059
F	0.90	1.50	0.035	0.059

**SMA Suggested Pad Layout**

**Note:**

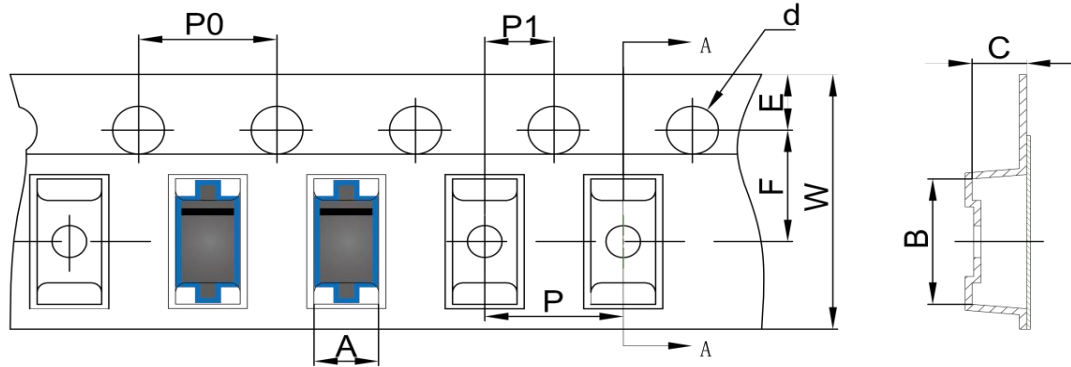
1. Controlling dimension: in millimeters
2. General tolerance:  $\pm 0.05\text{mm}$
3. The pad layout is for reference purposes only

**GENERAL PURPOSE RECTIFIER DIODE**
**SMA Tape and Reel**
**SMA Embossed Carrier Tape**

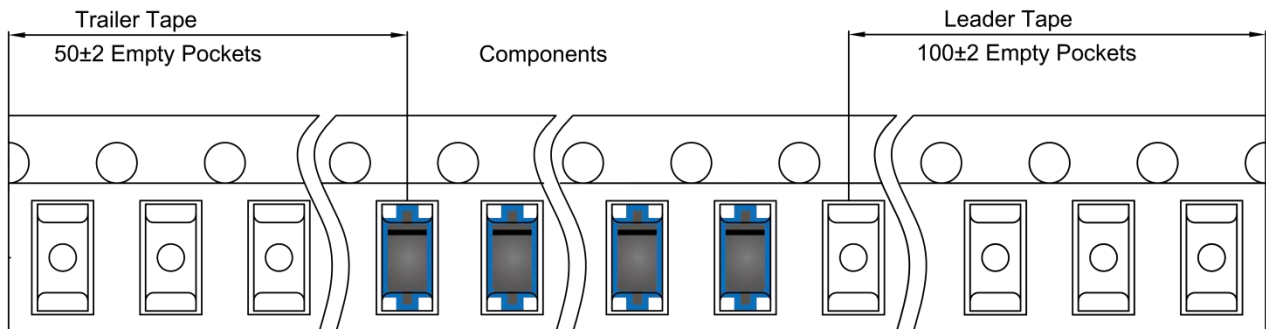
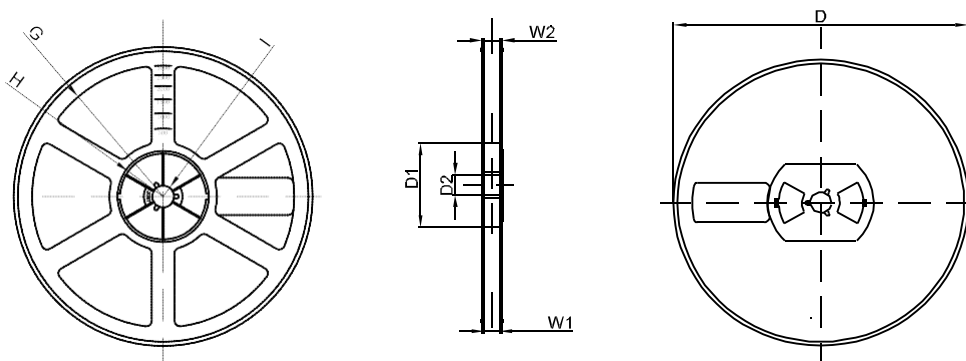
DIMENSIONS ARE IN MILLIMETER										
TYPE	A	B	C	d	E	F	P0	P	P1	W
SMA	2.89	5.35	2.68	Ø1.50	1.75	5.50	4.00	4.00	2.00	12.00
TOLERANCE	±0.1	±0.1	±0.1	±0.1	±0.1	±0.1	±0.1	±0.1	±0.1	±0.1

**SMA Tape Leader and Trailer**

**SMA Reel**

DIMENSIONS ARE IN MILLIMETER								
REEL OPTION	D	D1	D2	G	H	I	W1	W2
7" DIA	Ø178	54.40	13.00	R78	R25.60	R6.50	12.40	17.60
TOLERANCE	±2	±1	±1	±1	±1	±1	±1	±1