

Features

- Input Voltage Range: 1.75 V to 5.5 V
- Output Voltage Range: 0.9 V to 5 V
- $\pm 2\%$ Output Accuracy Over Line, Load Regulation, and Operating Temperature Range
- 300 mA Maximum Output Current
- Low Dropout Voltage: 150 mV Maximum at 300 mA
- High PSRR:
 - ◆ 81.9 dB at 1 kHz
 - ◆ 87.9 dB at 10 kHz
 - ◆ 61.4 dB at 100 kHz
 - ◆ 44.7 dB at 1 MHz
- 8.6 μV_{RMS} Output Voltage Noise
- Excellent Transient Response
- Output Reverse Current Protection
- Stable with a 1 μF or Larger Ceramic Output Capacitor
- Thermal Shutdown and Over-Current Protection
- Junction Temperature Range: -40°C to $+125^{\circ}\text{C}$
- Package Options:
 - ◆ SOT23-5
 - ◆ 1 \times 1 DFN-4
 - ◆ 0.65 \times 0.65 WLCSP-4

Applications

- Portable and Battery-Powered Equipment
- Mobile Phones and Tablets
- Digital Cameras and Audio Devices Power Supply
- Video Surveillance

Description

The TPL9032 series products are 300-mA high PSRR, ultra-low noise, low dropout linear regulators with high output accuracy. The TPL9032 series products support both fixed output voltage ranges from 0.9 V to 5 V and is stable with 1 μF or larger ceramic output capacitor.

The TPL9032 series products have high PSRR with 87.9 dB at 10 kHz and 8.6 μV_{RMS} ultra-low noise. These features make TPL9032 series products very suitable for noise-sensitive applications with high noise from previous stage power supply, such as high-performance analog devices, or high-definition imaging equipment. Output shortage protection and thermal overload protection circuits improves the reliability under heavy load conditions.

The TPL9032 series products provide SOT23-5, 1 \times 1 DFN-4, and 0.65 \times 0.65 WLCSP-4 packages with guaranteed operating junction temperature range (T_J) from -40°C to $+125^{\circ}\text{C}$.

Typical Application Schematic

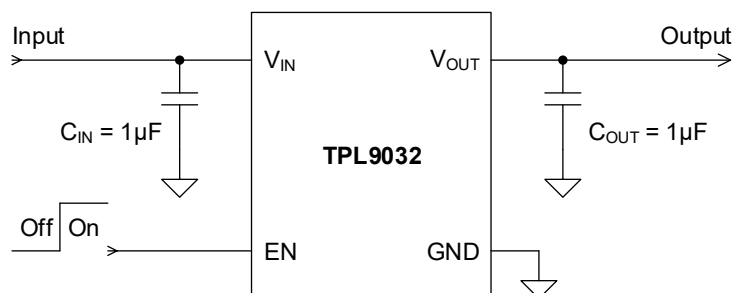

Product Family Table

Part Number	Orderable Number	Output Voltage	Package	Transport Media, Quantity	MSL	Marking information
TPL9032	TPL903209-S5TR ⁽¹⁾	0.9 V	SOT23-5	Tape and Reel, 3,000	MSL3	L8D
TPL9032	TPL903210-S5TR ⁽¹⁾	1.0 V	SOT23-5	Tape and Reel, 3,000	MSL3	L8E
TPL9032	TPL903211-S5TR ⁽¹⁾	1.1 V	SOT23-5	Tape and Reel, 3,000	MSL3	L8F
TPL9032	TPL903212-S5TR	1.2 V	SOT23-5	Tape and Reel, 3,000	MSL3	L8G
TPL9032	TPL903213-S5TR ⁽¹⁾	1.3 V	SOT23-5	Tape and Reel, 3,000	MSL3	L8H
TPL9032	TPL903215-S5TR	1.5 V	SOT23-5	Tape and Reel, 3,000	MSL3	L8I
TPL9032	TPL903216-S5TR ⁽¹⁾	1.6 V	SOT23-5	Tape and Reel, 3,000	MSL3	L8J
TPL9032	TPL903218-S5TR	1.8 V	SOT23-5	Tape and Reel, 3,000	MSL3	L8K
TPL9032	TPL903219-S5TR ⁽¹⁾	1.9 V	SOT23-5	Tape and Reel, 3,000	MSL3	L8L
TPL9032	TPL903221-S5TR ⁽¹⁾	2.1 V	SOT23-5	Tape and Reel, 3,000	MSL3	L8M
TPL9032	TPL903222-S5TR ⁽¹⁾	2.2 V	SOT23-5	Tape and Reel, 3,000	MSL3	L8N
TPL9032	TPL903224-S5TR ⁽¹⁾	2.4 V	SOT23-5	Tape and Reel, 3,000	MSL3	L8O
TPL9032	TPL903225-S5TR	2.5 V	SOT23-5	Tape and Reel, 3,000	MSL3	L8P
TPL9032	TPL903226-S5TR ⁽¹⁾	2.6 V	SOT23-5	Tape and Reel, 3,000	MSL3	L8Q
TPL9032	TPL903227-S5TR ⁽¹⁾	2.7 V	SOT23-5	Tape and Reel, 3,000	MSL3	L8R
TPL9032	TPL903228-S5TR	2.8 V	SOT23-5	Tape and Reel, 3,000	MSL3	L8T
TPL9032	TPL903229-S5TR	2.9 V	SOT23-5	Tape and Reel, 3,000	MSL3	L8V
TPL9032	TPL903230-S5TR	3.0 V	SOT23-5	Tape and Reel, 3,000	MSL3	L8W
TPL9032	TPL903231-S5TR ⁽¹⁾	3.1 V	SOT23-5	Tape and Reel, 3,000	MSL3	L8X
TPL9032	TPL903232-S5TR ⁽¹⁾	3.2 V	SOT23-5	Tape and Reel, 3,000	MSL3	L8Y
TPL9032	TPL903233-S5TR	3.3 V	SOT23-5	Tape and Reel, 3,000	MSL3	L8Z
TPL9032	TPL903235-S5TR ⁽¹⁾	3.5 V	SOT23-5	Tape and Reel, 3,000	MSL3	L81
TPL9032	TPL903236-S5TR	3.6 V	SOT23-5	Tape and Reel, 3,000	MSL3	L82
TPL9032	TPL903237-S5TR ⁽¹⁾	3.7 V	SOT23-5	Tape and Reel, 3,000	MSL3	L83
TPL9032	TPL903240-S5TR ⁽¹⁾	4.0 V	SOT23-5	Tape and Reel, 3,000	MSL3	L84
TPL9032	TPL903245-S5TR	4.5 V	SOT23-5	Tape and Reel, 3,000	MSL3	L85
TPL9032	TPL903250-S5TR ⁽¹⁾	5.0 V	SOT23-5	Tape and Reel, 3,000	MSL3	L86

(1) Future product, contact 3PEAK factory for more information and sample.

Part Number	Orderable Number	Output Voltage	Package	Transport Media, Quantity	MSL	Marking information
TPL9032	TPL903209-DF1R ⁽¹⁾	0.9 V	1×1 DFN-4	Tape and Reel, 12,000	MSL3	L8D
TPL9032	TPL903210-DF1R ⁽¹⁾	1.0 V	1×1 DFN-4	Tape and Reel, 12,000	MSL3	L8E
TPL9032	TPL903211-DF1R ⁽¹⁾	1.1 V	1×1 DFN-4	Tape and Reel, 12,000	MSL3	L8F
TPL9032	TPL903212-DF1R ⁽¹⁾	1.2 V	1×1 DFN-4	Tape and Reel, 12,000	MSL3	L8G
TPL9032	TPL903213-DF1R ⁽¹⁾	1.3 V	1×1 DFN-4	Tape and Reel, 12,000	MSL3	L8H
TPL9032	TPL903215-DF1R ⁽¹⁾	1.5 V	1×1 DFN-4	Tape and Reel, 12,000	MSL3	L8I
TPL9032	TPL903216-DF1R ⁽¹⁾	1.6 V	1×1 DFN-4	Tape and Reel, 12,000	MSL3	L8J
TPL9032	TPL903218-DF1R	1.8 V	1×1 DFN-4	Tape and Reel, 12,000	MSL3	L8K
TPL9032	TPL903219-DF1R ⁽¹⁾	1.9 V	1×1 DFN-4	Tape and Reel, 12,000	MSL3	L8L
TPL9032	TPL903221-DF1R ⁽¹⁾	2.1 V	1×1 DFN-4	Tape and Reel, 12,000	MSL3	L8M
TPL9032	TPL903222-DF1R ⁽¹⁾	2.2 V	1×1 DFN-4	Tape and Reel, 12,000	MSL3	L8N
TPL9032	TPL903224-DF1R ⁽¹⁾	2.4 V	1×1 DFN-4	Tape and Reel, 12,000	MSL3	L8O
TPL9032	TPL903225-DF1R	2.5 V	1×1 DFN-4	Tape and Reel, 12,000	MSL3	L8P
TPL9032	TPL903226-DF1R ⁽¹⁾	2.6 V	1×1 DFN-4	Tape and Reel, 12,000	MSL3	L8Q
TPL9032	TPL903227-DF1R ⁽¹⁾	2.7 V	1×1 DFN-4	Tape and Reel, 12,000	MSL3	L8R
TPL9032	TPL903228-DF1R ⁽¹⁾	2.8 V	1×1 DFN-4	Tape and Reel, 12,000	MSL3	L8T
TPL9032	TPL903229-DF1R	2.9 V	1×1 DFN-4	Tape and Reel, 12,000	MSL3	L8V
TPL9032	TPL903230-DF1R	3.0 V	1×1 DFN-4	Tape and Reel, 12,000	MSL3	L8W
TPL9032	TPL903231-DF1R	3.1 V	1×1 DFN-4	Tape and Reel, 12,000	MSL3	L8X
TPL9032	TPL903232-DF1R ⁽¹⁾	3.2 V	1×1 DFN-4	Tape and Reel, 12,000	MSL3	L8Y
TPL9032	TPL903233-DF1R	3.3 V	1×1 DFN-4	Tape and Reel, 12,000	MSL3	L8Z
TPL9032	TPL903235-DF1R ⁽¹⁾	3.5 V	1×1 DFN-4	Tape and Reel, 12,000	MSL3	L81
TPL9032	TPL903236-DF1R ⁽¹⁾	3.6 V	1×1 DFN-4	Tape and Reel, 12,000	MSL3	L82
TPL9032	TPL903237-DF1R ⁽¹⁾	3.7 V	1×1 DFN-4	Tape and Reel, 12,000	MSL3	L83
TPL9032	TPL903240-DF1R ⁽¹⁾	4.0 V	1×1 DFN-4	Tape and Reel, 12,000	MSL3	L84
TPL9032	TPL903245-DF1R ⁽¹⁾	4.5 V	1×1 DFN-4	Tape and Reel, 12,000	MSL3	L85
TPL9032	TPL903250-DF1R ⁽¹⁾	5.0 V	1×1 DFN-4	Tape and Reel, 12,000	MSL3	L86

(1) Future product, contact 3PEAK factory for more information and sample.

Part Number	Orderable Number	Output Voltage	Package	Transport Media, Quantity	MSL	Marking information
TPL9032	TPL903209-WS1R ⁽¹⁾	0.9 V	WLCSP-4	Tape and Reel, 3000	MSL3	8D
TPL9032	TPL903210-WS1R ⁽¹⁾	1.0 V	WLCSP-4	Tape and Reel, 3000	MSL3	8E
TPL9032	TPL903211-WS1R ⁽¹⁾	1.1 V	WLCSP-4	Tape and Reel, 3000	MSL3	8F
TPL9032	TPL903212-WS1R ⁽¹⁾	1.2 V	WLCSP-4	Tape and Reel, 3000	MSL3	8G
TPL9032	TPL903213-WS1R ⁽¹⁾	1.3 V	WLCSP-4	Tape and Reel, 3000	MSL3	8H
TPL9032	TPL903215-WS1R ⁽¹⁾	1.5 V	WLCSP-4	Tape and Reel, 3000	MSL3	8I
TPL9032	TPL903216-WS1R ⁽¹⁾	1.6 V	WLCSP-4	Tape and Reel, 3000	MSL3	8J
TPL9032	TPL903218-WS1R ⁽¹⁾	1.8 V	WLCSP-4	Tape and Reel, 3000	MSL3	8K
TPL9032	TPL903219-WS1R ⁽¹⁾	1.9 V	WLCSP-4	Tape and Reel, 3000	MSL3	8L
TPL9032	TPL903221-WS1R ⁽¹⁾	2.1 V	WLCSP-4	Tape and Reel, 3000	MSL3	8M
TPL9032	TPL903222-WS1R ⁽¹⁾	2.2 V	WLCSP-4	Tape and Reel, 3000	MSL3	8N
TPL9032	TPL903224-WS1R ⁽¹⁾	2.4 V	WLCSP-4	Tape and Reel, 3000	MSL3	8O
TPL9032	TPL903225-WS1R	2.5 V	WLCSP-4	Tape and Reel, 3000	MSL3	8P
TPL9032	TPL903226-WS1R ⁽¹⁾	2.6 V	WLCSP-4	Tape and Reel, 3000	MSL3	8Q
TPL9032	TPL903227-WS1R ⁽¹⁾	2.7 V	WLCSP-4	Tape and Reel, 3000	MSL3	8R
TPL9032	TPL903228-WS1R ⁽¹⁾	2.8 V	WLCSP-4	Tape and Reel, 3000	MSL3	8T
TPL9032	TPL903229-WS1R ⁽¹⁾	2.9 V	WLCSP-4	Tape and Reel, 3000	MSL3	8V
TPL9032	TPL903230-WS1R ⁽¹⁾	3.0 V	WLCSP-4	Tape and Reel, 3000	MSL3	8W
TPL9032	TPL903231-WS1R	3.1 V	WLCSP-4	Tape and Reel, 3000	MSL3	8X
TPL9032	TPL903232-WS1R ⁽¹⁾	3.2 V	WLCSP-4	Tape and Reel, 3000	MSL3	8Y
TPL9032	TPL903233-WS1R ⁽¹⁾	3.3 V	WLCSP-4	Tape and Reel, 3000	MSL3	8Z
TPL9032	TPL903235-WS1R ⁽¹⁾	3.5 V	WLCSP-4	Tape and Reel, 3000	MSL3	81
TPL9032	TPL903236-WS1R ⁽¹⁾	3.6 V	WLCSP-4	Tape and Reel, 3000	MSL3	82
TPL9032	TPL903237-WS1R ⁽¹⁾	3.7 V	WLCSP-4	Tape and Reel, 3000	MSL3	83
TPL9032	TPL903240-WS1R ⁽¹⁾	4.0 V	WLCSP-4	Tape and Reel, 3000	MSL3	84
TPL9032	TPL903245-WS1R ⁽¹⁾	4.5 V	WLCSP-4	Tape and Reel, 3000	MSL3	85
TPL9032	TPL903250-WS1R ⁽¹⁾	5.0 V	WLCSP-4	Tape and Reel, 3000	MSL3	86

(1) Future product, contact 3PEAK factory for more information and sample.

Table of Contents

Features	1
Applications	1
Description	1
Typical Application Schematic	1
Product Family Table	2
Table of Contents	5
Revision History	6
Pin Configuration and Functions	7
Specifications	8
Absolute Maximum Ratings	8
ESD Ratings	8
Recommended Operating Conditions	8
Thermal Information	8
Electrical Characteristics	9
Typical Performance Characteristics	10
Detailed Description	12
Overview	12
Functional Block Diagram	12
Feature Description	12
Application and Implementation	14
Application Information	14
Typical Application	14
Layout Requirements	15
Tape and Reel Information	16
Package Outline Dimensions	17
SOT23-5	17
1×1 DFN-4	18
0.65×0.65 WLCSP-4	19

Revision History

Date	Revision	Notes
2019/08/31	Rev.Pre	Preliminary Version
2020/04/08	Rev.A.0	Initial Released
2021/05/14	Rev.A.1	Add Tape and Reel Information in Page 16

Pin Configuration and Functions

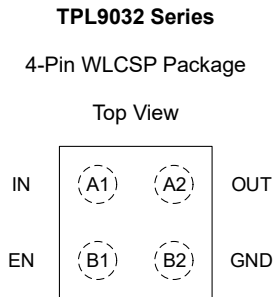
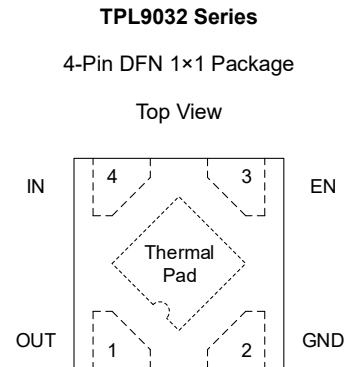
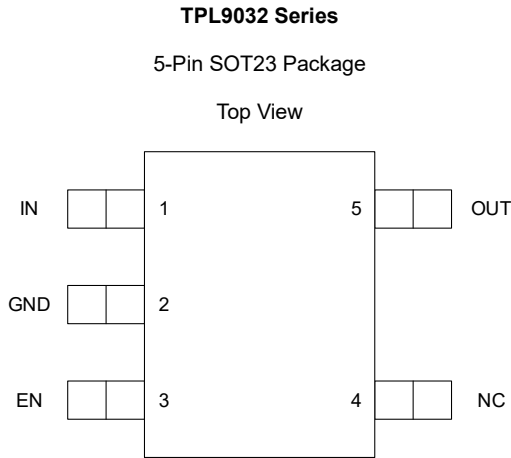

Pin Functions

NAME	PIN NUMBER			TYPE	DESCRIPTION
	SOT23-5	DFN-4	WLCSP-4		
EN	3	3	B1	I	Regulator enable pin. Drive EN high to turn on the regulator; drive EN low to turn off the regulator. For automatic startup, connect EN to IN directly.
GND	2	2	B2	–	Ground reference pin. Connect GND pin to PCB ground plane directly.
IN	1	4	A1	I	Input voltage pin. Bypass IN to GND with a 1 μ F or greater capacitor.
NC	4	–	–	–	No connection.
OUT	5	1	A2	O	Regulated output voltage pin. Bypass OUT to GND with a 1 μ F or greater capacitor.

(1) Thermal Pad **MUST** be connected to PCB ground plane directly.

Specifications

Absolute Maximum Ratings

		MIN	MAX	UNIT
IN, EN		-0.3	6	V
OUT		-0.3	6	V
T _J	Junction Temperature Range	-40	150	°C
T _{STG}	Storage Temperature Range	-65	150	°C
T _L	Lead Temperature (Soldering 10 sec)		260	°C

(1) Stresses beyond the Absolute Maximum Ratings may permanently damage the device.

(2) All voltage values are with respect to GND.

ESD Ratings

		Condition	Minimum Level	UNIT
HBM	Human Body Model ESD	ANSI/ESDA/JEDEC JS-001	±6000	V
CDM	Charged Device Model ESD	ANSI/ESDA/JEDEC JS-002	±1500	V

Recommended Operating Conditions

		MIN	MAX	UNIT
IN		1.75	5.5	V
EN		0	V _{IN}	V
OUT		0	5.5	V
C _{OUT}		1	10	μF
ESR of C _{OUT}		0.001	0.1	Ω
T _J	Junction Temperature Range	-40	125	°C
P _D	Power Dissipation	0	400	mW

Thermal Information

PACKAGE	θ _{JA}	θ _{JC}	UNIT
SOT23-5	280	62	°C/W
1×1 DFN-4	210	110	°C/W
0.65×0.65 WLCSP-4	TBD	TBD	°C/W

Electrical Characteristics

All test condition: $V_{IN} = V_{OUT(NOM)} + 1V$, $I_{OUT} = 1\text{ mA}$, $C_{IN} = 1\text{ }\mu\text{F}$, $C_{OUT} = 1\text{ }\mu\text{F}$, $-40^{\circ}\text{C} \leq T_J \leq +125^{\circ}\text{C}$, unless otherwise noted.

PARAMETER		TEST CONDITIONS	MIN	TYP	MAX	UNIT
Supply Input Voltage and Current						
V_{IN}	Input supply voltage range		1.75		5.5	V
I_{GND}	Ground pin current	$I_{OUT} = 0\text{ mA}$		120		μA
I_{SHDN}	Shutdown current	EN = GND		0.02	2	μA
Enable Input Voltage and Current						
$V_{IH(EN)}$	EN logic-input high level (enable)		1.2		V_{IN}	V
$V_{IL(EN)}$	EN logic-input low level (disable)		0		0.4	V
I_{EN}	EN pin leakage current	$V_{EN} = 5\text{ V}$		1	2	μA
Regulated Output Voltage and Current						
V_{OUT}	Output voltage accuracy	$-40^{\circ}\text{C} \leq T_J \leq +125^{\circ}\text{C}$	-2%		2%	
ΔV_{OUT}	Line regulation	$V_{IN} = V_{OUT(NOM)} + 1\text{ V to } 5.5\text{ V}$		1		mV
	Load regulation	$V_{IN} = V_{OUT(NOM)} + 1\text{ V}$, $I_{OUT} = 1\text{ mA to } 300\text{ mA}$		5		mV
$V_{DO}^{(1)}$	Dropout voltage	$V_{OUT} = 3.3\text{V}$, $I_{OUT} = 100\text{mA}$		28		mV
		$V_{OUT} = 3.3\text{V}$, $I_{OUT} = 300\text{mA}$		80	180	mV
I_{OUT}	Output voltage	V_{OUT} in regulation	0		300	mA
I_{CL}	Output current limit	$V_{OUT} = 0.9 \times V_{OUT(NOM)}$	500	800		mA
I_{SC}	Short-circuit current limit	$R_{LOAD} = 20\text{ m}\Omega$, $T_A = 25^{\circ}\text{C}$		100		mA
R_{DIS}	Active output discharge resistance	$V_{EN} < V_{IL(EN)}$		290		Ω
PSRR	Power supply rejection ratio	$I_{OUT} = 20\text{ mA}$, $f = 100\text{ Hz}$		82.1		dB
		$I_{OUT} = 20\text{ mA}$, $f = 1\text{ kHz}$		81.9		dB
		$I_{OUT} = 20\text{ mA}$, $f = 10\text{ kHz}$		87.9		dB
		$I_{OUT} = 20\text{ mA}$, $f = 100\text{ kHz}$		61.4		dB
		$I_{OUT} = 20\text{ mA}$, $f = 1\text{ MHz}$		44.7		dB
V_N	Output noise voltage	$I_{OUT} = 150\text{ mA}$, BW = 10Hz to 100 kHz		8.6		μV_{RMS}
t_{STR}	Start-up time	V_{OUT} reaches 95% of nominal output voltage after EN = high		750		μs
Temperature Range						
T_{SD}	Thermal shutdown temperature			165		$^{\circ}\text{C}$
	Thermal shutdown hysteresis			15		$^{\circ}\text{C}$

(1) Dropout voltage is the minimum input to output voltage differential needed to maintain regulation at a specified output current and measure for $V_{OUT(NOM)} \geq 1.8\text{V}$. In dropout, the output voltage will be equal to: $V_{IN} - V_{DROPOUT}$.

Typical Performance Characteristics

All test condition: $V_{IN} = V_{OUT(NOM)} + 1V$, $I_{OUT} = 1\text{ mA}$, $C_{IN} = 1\text{ }\mu\text{F}$, $C_{OUT} = 1\text{ }\mu\text{F}$, $-40^{\circ}\text{C} \leq T_J \leq +125^{\circ}\text{C}$, unless otherwise noted.

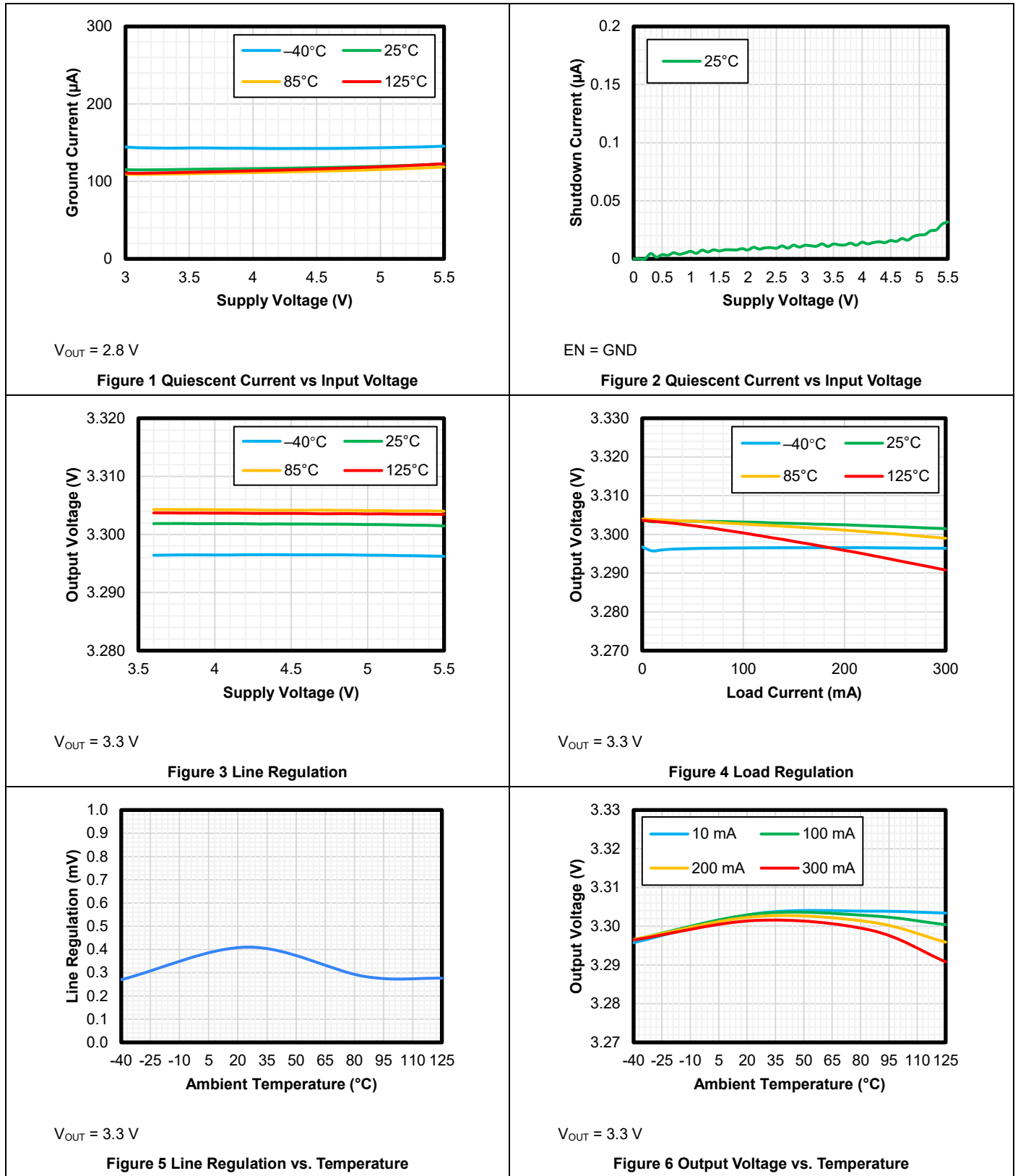

Typical Performance Characteristics (continued)

All test condition: $V_{IN} = V_{OUT(NOM)} + 1V$, $I_{OUT} = 1\text{ mA}$, $C_{IN} = 1\text{ }\mu\text{F}$, $C_{OUT} = 1\text{ }\mu\text{F}$, $-40^{\circ}\text{C} \leq T_J \leq +125^{\circ}\text{C}$, unless otherwise noted.

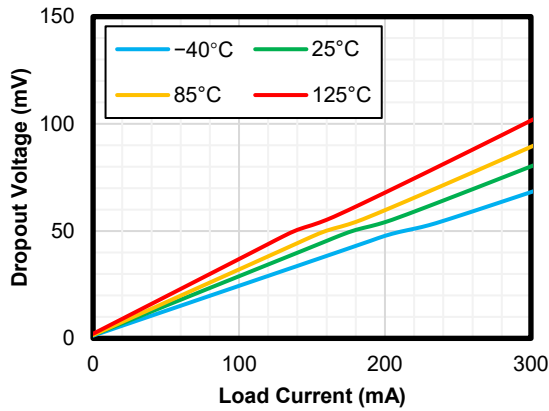

Figure 7. Dropout Voltage vs Output Current

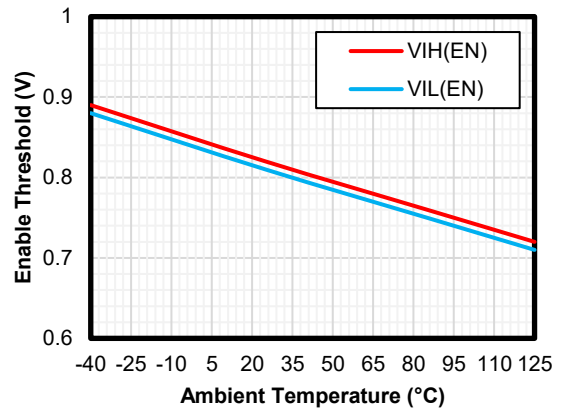

Figure 8. Enable Threshold vs. Temperature

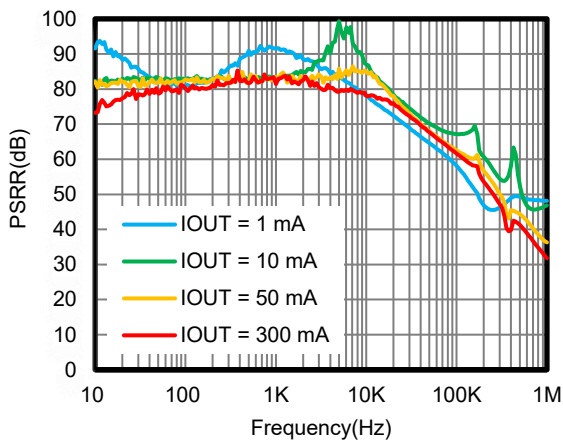

Figure 9. PSRR

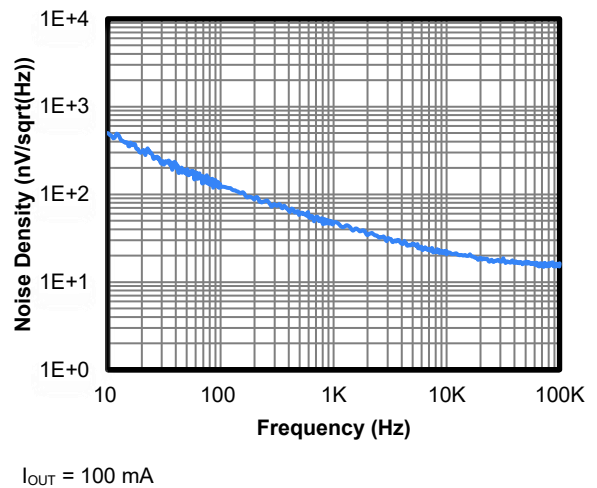
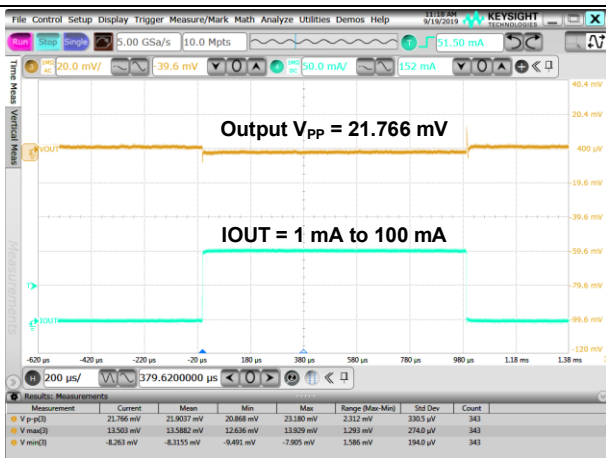
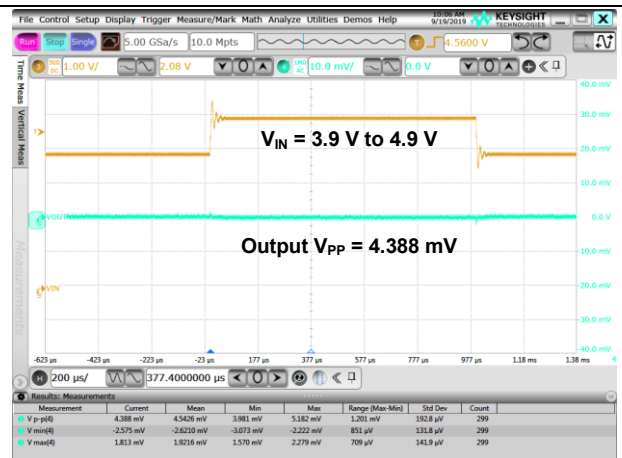

Figure 10. Noise



$I_{OUT} = 1\text{ mA to }100\text{ mA}$ $V_{PP} = 21.77\text{ mV}$

Figure 11 Load Transient



$V_{IN} = 3.9\text{ V to }4.9\text{ V}$ $V_{PP} = 4.388\text{ mV}$

Figure 12 Line Transient

Detailed Description

Overview

The TPL9032 series products are 300-mA high PSRR, ultra-low noise, low dropout linear regulators with high output accuracy. The TPL9032 series products support both fixed output voltage ranges from 0.9 V to 5 V is stable with 1 μ F or larger ceramic output capacitor.

The TPL9032 series products have high PSRR with 87.9 dB at 10 kHz and 8.6 μ V_{RMS} ultra-low noise. These features make TPL9032 series products very suitable for noise-sensitive applications with high noise from previous stage power supply, such as high-performance analog devices, or high-definition imaging equipment. Output shortage protection and thermal overload protection circuits improves the reliability under heavy load conditions.

Functional Block Diagram

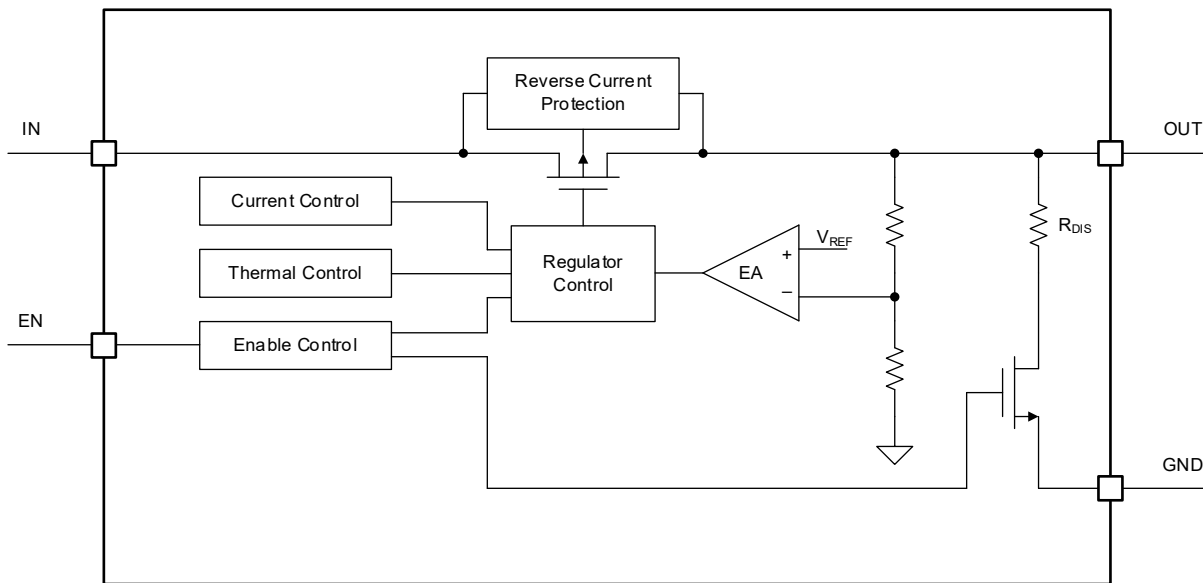

Figure 13 Functional Block Diagram

Feature Description

Enable (EN)

The enable pin (EN) is active high. Connect this pin to the GPIO of an external processor or digital logic control circuit to enable and disable the device. Or connect this pin to the IN pin for self-bias applications.

Operating Voltage Range (VIN)

The TPL9032 series does not include any dedicated UVLO circuitry. The output voltage of the TPL9032 series is not well regulated until VIN exceeds 1.75 V or (VOUT + VDO).

Regulated Output Voltage (VOUT)

The TPL9032 series are available in fixed voltage versions of 0.9 V to 5 V. When the input voltage is higher than $V_{OUT(NOM)} + 1$, output pin is the regulated output based on the selected voltage version. When the input voltage falls below $V_{OUT(NOM)} + 1$, output pin tracks the input voltage minus the dropout voltage based on the load current.

Reverse-Current Protection (RCP)

The TPL9032 series provide the reverse-current protection (RCP) to prevent output reverse current. If large capacitors been used at the output, there would be large reverse current when the input voltage is lower than output voltage. The TPL9032 series can shut off the regulator and body diode path to prevent the device damaged from reverse current fault.

Current Limit

The TPL9032 series integrate an internal current limit that helps to protect the regulator during fault conditions. When the output is shorted, the LDO supplies a typical current of 100 mA. Output voltage is not regulated when the device is in current limit, and $V_{OUT} = I_{CL} \times R_{LOAD}$.

Thermal Shutdown

During normal operation, LDO junction temperature should not exceed 125°C. When the junction temperature exceeds the thermal shutdown threshold, the LDO shut down the output immediately. Until when the junction temperature falls below the thermal shutdown threshold minus thermal shutdown hysteresis, the output turns on again.

Application and Implementation

NOTE

Information in the following applications sections is not part of the 3PEAK's component specification and 3PEAK does not warrant its accuracy or completeness. 3PEAK's customers are responsible for determining suitability of components for their purposes. Customers should validate and test their design implementation to confirm system functionality.

Application Information

The TPL9032 devices are a series of 300-mA high PSRR, ultra-low noise, low-dropout linear regulator. The following application schematic shows a typical usage of the TPL9032 series.

Typical Application

Figure 14 shows the typical application schematic of the TPL9032 series.

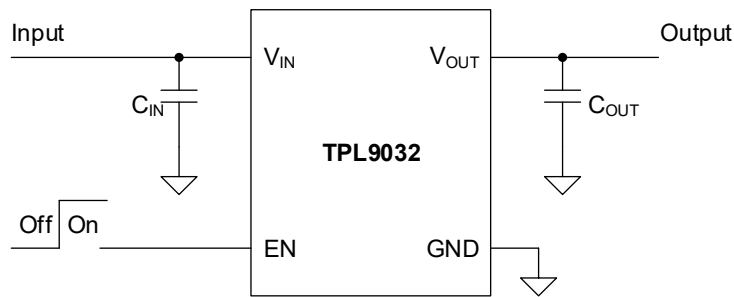

Figure 14 Typical Application Schematic

Input Capacitor and Output Capacitor

3PEAK recommends adding a 1 μF or greater capacitor with a 0.1 μF bypass capacitor in parallel at IN pin to keep the input voltage stable. The voltage rating of the capacitors must be greater than the maximum input voltage.

To ensure loop stability, the TPL9032 series requires an output capacitor of 1 μF or greater. 3PEAK recommends selecting a X5R- or X7R-type ceramic capacitor with low ESR over temperature.

Both input capacitors and output capacitors must be placed as close to the device pins as possible.

Power Dissipation

During normal operation, LDO junction temperature should not exceed 125°C. Using below equations to calculate the power dissipation and estimate the junction temperature.

The power dissipation can be calculated using [Equation 1](#).

$$P_D = (V_{IN} - V_{OUT}) \times I_{OUT} + V_{IN} \times I_{GND} \tag{1}$$

The junction temperature can be estimated using [Equation 2](#). θ_{JA} is the junction-to-ambient thermal resistance.

$$T_J = T_A + P_D \times \theta_{JA} \tag{2}$$

Layout Requirements

- Both input capacitors and output capacitors must be placed as close to the device pins as possible.
- It is recommended to bypass the input pin to ground with a 0.1 μF bypass capacitor. The loop area formed by the bypass capacitor connection, IN pin and the GND pin of the system must be as small as possible.
- It is recommended to use wide trace lengths or thick copper weight to minimize $I \times R$ drop and heat dissipation.

Tape and Reel Information

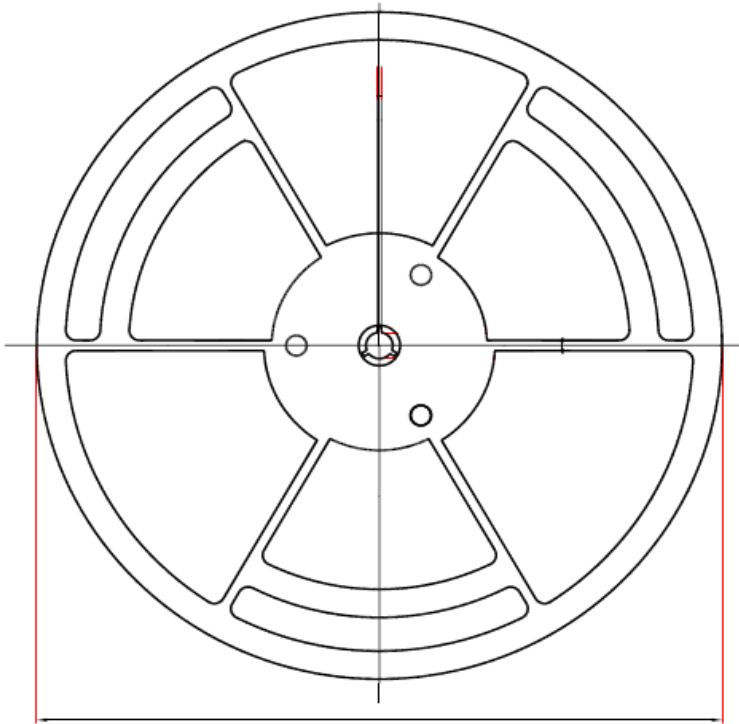

D1: Reel Diameter

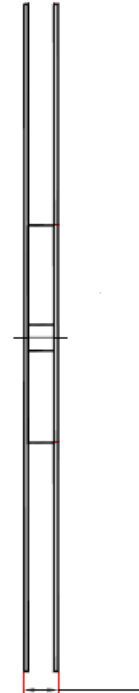

W1: Reel Width

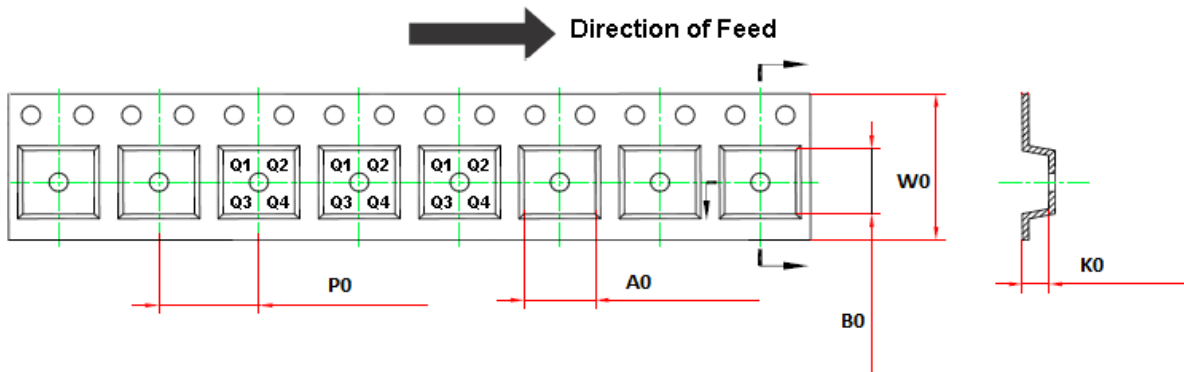

Order Number	Package	D1	W1	A0	B0	K0	P0	W0	Pin1 Quadrant
TPL9032xx-S5TR ⁽¹⁾	SOT23-5	180.0	13.1	3.2	3.2	1.4	4.0	8.0	Q3
TPL9032xx-DF1R ⁽²⁾	1×1 DFN-4	180.0	10.0	1.16	1.16	0.5	2.0	8.0	Q1
TPL903228-DF1R	1×1 DFN-4	180.0	10.0	1.16	1.16	0.5	2.0	8.0	Q2
TPL903229-DF1R	1×1 DFN-4	180.0	10.0	1.16	1.16	0.5	2.0	8.0	Q2
TPL9032xx-WS1R ⁽¹⁾	0.65×0.65 WLCSP-4	180.0	12.3	0.75	0.75	0.5	4	8	Q1

(1) Output voltage value, xx = 09 to 50. e.g. 33 means 3.3 V output voltage.

(2) Output voltage 2.8V and 2.9V are not included.

Package Outline Dimensions

SOT23-5

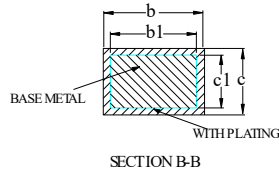
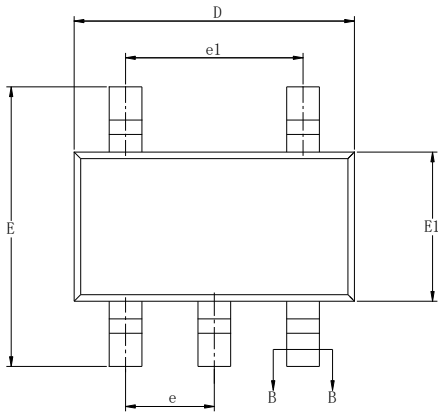
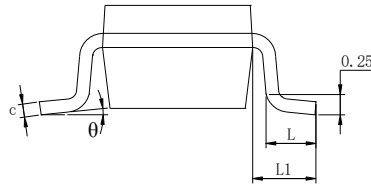
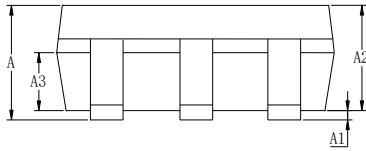

SYMBOL	MILLIMETER		
	MIN	NOM	MAX
A	—	—	1.25
A1	0.04	—	0.10
A2	1.00	1.10	1.20
A3	0.60	0.65	0.70
b	0.33	—	0.41
b1	0.32	0.35	0.38
c	0.15	—	0.19
c1	0.14	0.15	0.16
D	2.82	2.92	3.02
E	2.60	2.80	3.00
E1	1.50	1.60	1.70
e	0.95BSC		
e1	1.90BSC		
L	0.30	—	0.60
L1	0.60REF		
θ	0	—	8°

1×1 DFN-4

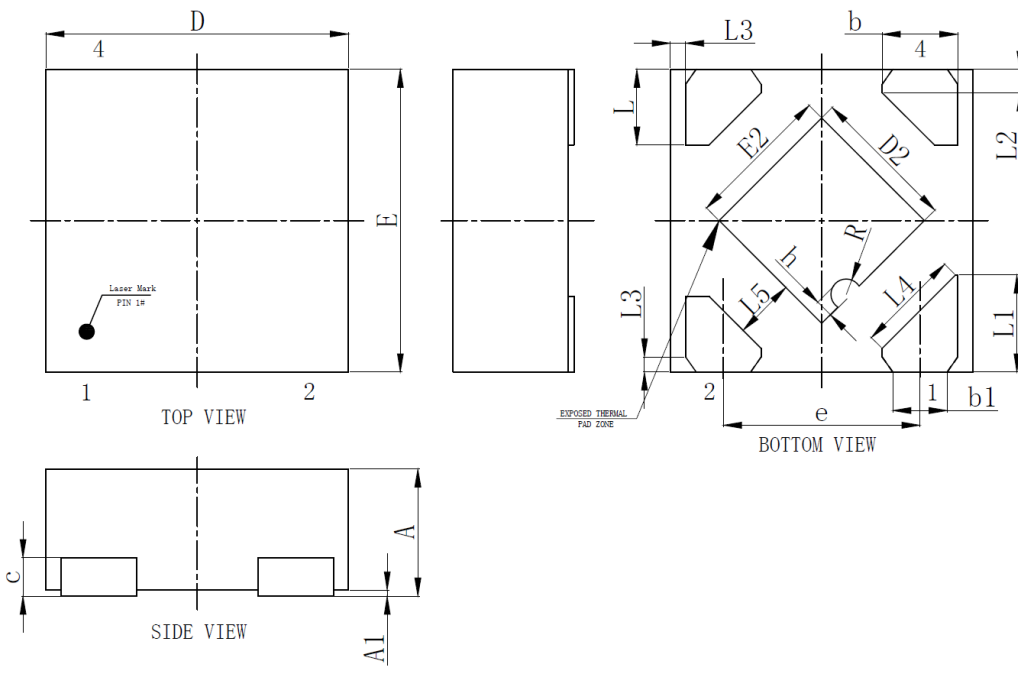

SYMBOL	MILLIMETER		
	MIN	NOM	MAX
A	0.35	-	0.40
A1	0.00	0.02	0.05
b	0.20	0.25	0.30
b1	0.13	0.18	0.23
c	0.07	0.12	0.17
D	0.95	1.00	1.05
D2	0.43	0.48	0.53
e	0.65BSC		
E	0.95	1.00	1.05
E2	0.43	0.48	0.53
L	0.20	0.25	0.30
L1	0.27	0.32	0.37
L2	0.077REF		
L3	0.05REF		
L4	0.34REF		
L5	0.20REF		
R	0.05REF		
h	0.06REF		

0.65×0.65 WLCSP-4

CSP-4L_μ

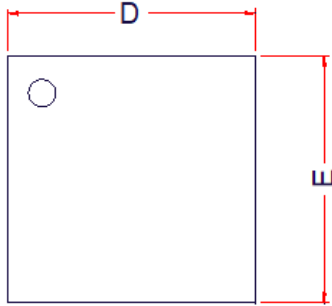

TOP VIEW

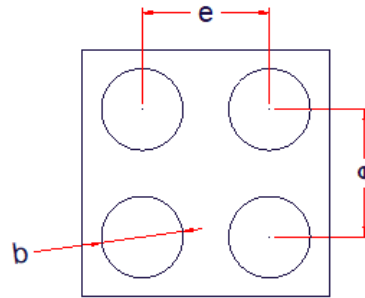

BOTTOM VIEW

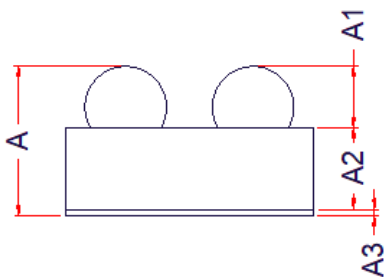

SIDE VIEW

Symbol	Dimensions in Millimeters		
	Min.	Typ.	Max.
A	0.390	0.420	0.450
A1	0.130	0.145	0.160
A2	0.230	0.240	0.250
A3	0.025 Ref.		
D	0.630	0.655	0.680
E	0.630	0.655	0.680
e	0.35 BSC		
b	0.165	0.185	0.205

 **3PEAK and the 3PEAK logo are registered trademarks of 3PEAK INCORPORATED. All other trademarks are the property of their respective owners.**