

HFD4

SUBMINIATURE SIGNAL RELAY



File No.:E133481



File No.:R50333270



File No.:CQC16002154335(Single side stable)
CQC16002154336(Latching)

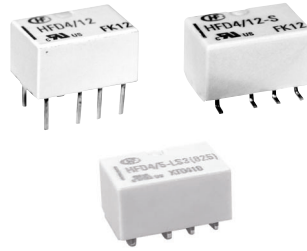

Features

- Subminiature signal relay of 4th generation
- Surge withstand voltage up to 2500V
- Meets EC62368-1
- High contact capacity 2A 30VDC
- Providing J-leg SMT version for intensive installation
- Single side stable and latching type available
- High temperature resistant products at 105°C are available
- Products compliant with IEC60079 available
- Products compliant with IEC 60335-1 available
- Monostable sensitive type with 100mV coil power is available
- Low halogen products conforming to IEC 61249-2-21 are available

RoHS compliant

CONTACT DATA

Contact arrangement	2C
Contact resistance ¹⁾	100mΩ max. (at 10mA 30mVDC)
Contact material	AgNi + Au plated
Contact rating (Res. load)	1A 30VDC 0.3A 125VAC
Max. switching current	2A
Max. switching voltage	250VAC / 220VDC
Max. switching power	62.5VA / 60W
Min. applicable load ²⁾	10mV 10μA
Mechanical endurance	1 x 10 ⁸ ops
Electrical endurance ³⁾	1 x 10 ⁵ ops (AgNi + Au plated, 0.3A 125VAC, Resistive load, at 85°C, 1s on 9s off)

- Notes:**1) The data shown above are initial values.
2) Min. applicable load is reference value. Please perform the confirmation test with the actual load before production since reference value may change according to switching frequencies, environmental conditions and expected contact resistance and reliability.
3) Electric endurance data are collected in the NO or NC contact test.

COIL

Coil power	Single side stable	See "COIL DATA"
	1 coil latching	See "COIL DATA"
Temperature rise	50K max.(At 1A load, 85°C environment)	

HIGH FREQUENCY¹⁾

Frequency	100MHz
Insertion loss	0.04dB (Typ.)
Voltage standing wave ratio V.SWR	1.06 (Typ.)
Isolation	43dB (Typ.)

- Notes:**1) Applicable to 428 version. Please refer to the "ORDERING INFORMATION" for more details;
2) The characteristic impedance of the measuring system is 50 Ω;
3) The data shown above are initial values;
4) If you need higher frequency band, please contact us.

CHARACTERISTICS

Insulation resistance	1000MΩ (at 500VDC)	
Dielectric strength	Between coil & contacts	1600VAC 1min
	Between open contacts	1000VAC 1min
	Between contact sets	1800VAC 1min
Surge withstand voltage	Between open contacts (10/160μs)	1500VAC (FCC part 68)
	Between coil & contacts (2/10μs)	2500VAC (Telecordia)
Operate time (Set time)	3ms max.	
Release time (Reset time)	3ms max.	
Ambient temperature	-40°C to 85°C -40°C to 105°C ²⁾	
Humidity	5% to 85% RH	
Vibration resistance	10Hz to 55Hz 3.3mm DA	
Shock resistance	Functional	735m/s ²
	Destructive	980m/s ²
Termination	DIP, SMT	
Unit weight	Approx. 0.8g	
Moisture sensitivity levels (Only for SMT type, JEDEC-STD-020)	MSL 3	
Construction	Plastic sealed	

- Notes:** 1) The data shown above are initial values;
2) The 888 version is for applications at 105°C.

SAFETY APPROVAL RATINGS

UL/CUL	AgNi + Au plated	1A 30VDC at 85°C
		2A 30VDC at 40°C
TUV	AgNi + Au plated	0.5A 125VDC at 40°C
		0.3A 125VAC at 85°C
		0.5A 125VAC at 40°C
		1A 30VDC at 85°C
		0.3A 125VAC at 85°C
		0.5A 125VAC at 85°C

- Notes:** 1) All values unspecified are at room temperature.
2) Only typical loads are listed above. Other load specifications can be available upon request.



HONGFA RELAY

ISO9001, IATF16949, ISO14001, OHSAS18001, IECQ QC 080000 CERTIFIED

2023 Rev. 1.00

COIL DATA

at 23°C

Single side stable and Standard type

Coil Code	Nominal Voltage VDC ⁽¹⁾	Initial Pick-up Voltage VDC ₁ max. ⁽¹⁾	Initial Drop-out Voltage VDC min. ⁽¹⁾	Coil Resistance Ω	Rated coil power mW approx.	Max. Voltage VDC ⁽⁴⁾
HFD4/1.5	1.5	1.13	0.15	16 x (1±10%)	140	3.0
HFD4/2.4	2.4	1.8	0.24	41 x (1±10%)	140	4.8
HFD4/3	3	2.25	0.3	64.3 x (1±10%)	140	6.0
HFD4/4.5	4.5	3.38	0.45	145 x (1±10%)	140	9.0
HFD4/5	5	3.75	0.5	178 x (1±10%)	140	10
HFD4/6	6	4.5	0.6	257 x (1±10%)	140	12
HFD4/9	9	6.75	0.9	579 x (1±10%)	140	18
HFD4/12	12	9	1.2	1028 x (1±10%)	140	24
HFD4/24	24	18	2.4	2880 x (1±10%)	200	48

Monostable sensitive type(478 version)

Coil Code	Nominal Voltage VDC ⁽¹⁾	Initial Pick-up Voltage VDC ₁ max. ⁽¹⁾	Initial Drop-out Voltage VDC min. ⁽¹⁾	Coil Resistance Ω	Rated coil power mW approx.	Max. Voltage VDC ⁽⁴⁾
HFD4/1.5	1.5	1.2	0.15	22.5 x (1±10%)	100	3.0
HFD4/2.4	2.4	1.92	0.24	58 x (1±10%)	100	4.8
HFD4/3	3	2.4	0.3	90 x (1±10%)	100	6.0
HFD4/4.5	4.5	3.6	0.45	203 x (1±10%)	100	9.0
HFD4/5	5	4	0.5	250 x (1±10%)	100	10
HFD4/6	6	4.8	0.6	360 x (1±10%)	100	12
HFD4/9	9	7.2	0.9	810 x (1±10%)	100	18
HFD4/12	12	9.6	1.2	1440 x (1±10%)	100	24
HFD4/24	24	19.2	2.4	5760 x (1±10%)	100	48

1 coil latching

Coil Code	Nominal Voltage VDC ⁽¹⁾	Initial Pick-up Voltage VDC ₁ max. ⁽¹⁾	Initial Drop-out Voltage VDC ₁ min. ⁽¹⁾	Coil Resistance Ω	Rated coil power mW approx.	Max. Voltage VDC ⁽⁴⁾
HFD4/1.5-L	1.5	1.13	1.13	22.5 x (1±10%)	100	3.0
HFD4/2.4-L	2.4	1.8	1.8	58x (1±10%)	100	4.8
HFD4/3-L	3	2.25	2.25	90 x (1±10%)	100	6.0
HFD4/4.5-L	4.5	3.38	3.38	203 x (1±10%)	100	9.0
HFD4/5-L	5	3.75	3.75	250 x (1±10%)	100	10
HFD4/6-L	6	4.5	4.5	360 x (1±10%)	100	12
HFD4/9-L	9	6.75	6.75	810 x (1±10%)	100	18
HFD4/12-L	12	9	9	1440 x (1±10%)	100	24
HFD4/24-L	24	18	18	2880 x (1±10%)	200	48

COIL DATA

at 23°C

Notes:1) The data shown above are initial values.

2) To supply rated step voltage to coil is the foundation of relay proper operation. Please make sure the applied voltage to the coil reach at rated values.

Please refer to the typical diagram below for single side stable relay. The "V_coil" is the rated voltage:

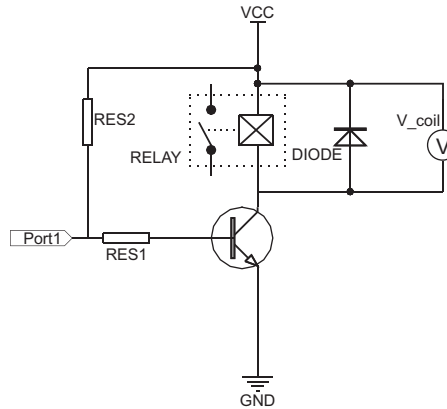

3) In case 5V of transistor drive circuit, it is recommended to use 4.5V type relay, and 3V to use 2.4V type relay.

4) For monostable relays, if you need to drop down voltage and hold mode after reliably operating, make sure that the effective value of holding voltage is not less than 60% of the rated voltage.

5) Maximum voltage refers to the maximum voltage which relay coil could endure in a short period of time.

6) When user's requirements can't be found in the above table, special order allowed.

7) During the relay pick-up or drop-out processes, there are stages of contact pressure change, contact vibration and unstable contact etc. When the voltage applied to coil is gradually changed, it will lengthen the unstable stage and affect relay endurance. To reduce this influence, please apply step voltage (switching circuit) to relay coil.

ORDERING INFORMATION

Type	HFD4 /	24	-L	S	R	(XXX)
Coil voltage	1.5, 2.4, 3, 4.5, 5, 6, 9, 12, 24VDC					
Sort	L: 1 coil latching		Nil: Single side stable			
Terminal type	S: Standard SMT		S1: Short terminal SMT			
	S3: J-legs SMT		Nil: DIP			
Packing style	R: Tape and reel packing (Only for SMT type) ¹⁾					
	Nil: Tube packing (Only for DIP type)					
Special code ³⁾	XXX: Customer special requirement		Nil: Standard			
	For instance: (478) indicates a monostable sensitive product with a rated coil power of 100mW;					
	Product with 888 suffix is for application at 105°C;					
	(356) indicates a low-halogen product that meets the requirements of IEC 61249-2-21.					

Notes: 1) R type (tape and reel) packing is moisture-proof which meets requirement of MSL-3. Please choose R type packing for SMT products.

For R type, the letter "R" will only be printed on packing tag but not on relay cover. Tube packing is normally not available for SMT products unless specially requested by customer. But please note that tube packing is not moisture-proof so please bake the products before use according to description of Notice 10 herewith. In addition, tube packaging will be adopted when the ordering quantity of R type is equal to or less than 100 pieces unless otherwise specified.

2) When coil sort, contact material, terminal type or packing style are needed, please add "-" after coil voltage is selected. For instance, HFD4/24-SR.

3) The customer special requirement express as special code after evaluating by Hongfa.

4) The standard tube length is 520mm. Any special requirement needed, please contact us for more details.

5) For products that should meet the explosion-proof requirements of "IEC 60079 series", please note [Ex] after the specification while placing orders. Not all products have explosion-proof certification, so please contact us if necessary, in order to select the suitable products.

OUTLINE DIMENSIONS, WIRING DIAGRAM AND PC BOARD LAYOUT

Unit: mm

Outline Dimensions

PCB Layout (Bottom view)

DIP type

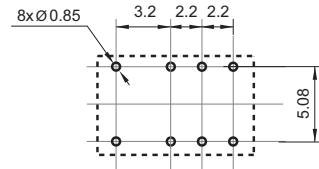
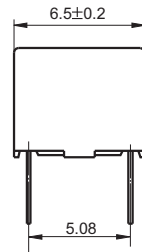
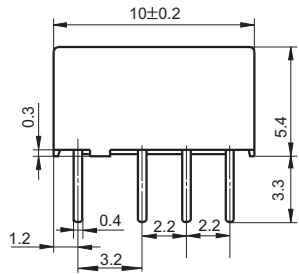

Standard SMT type

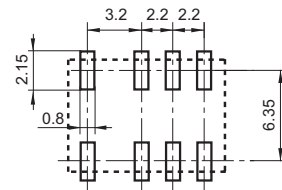
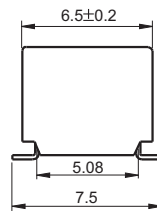
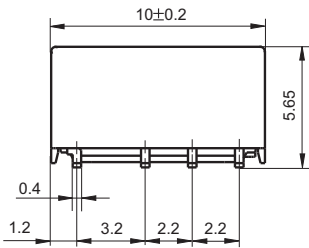

Short terminal SMT type

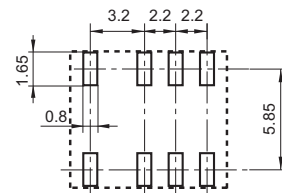
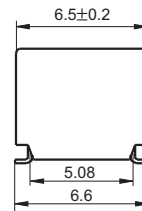
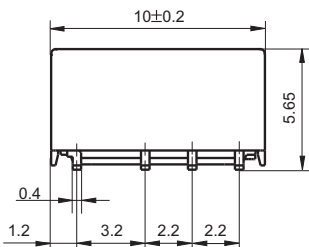

OUTLINE DIMENSIONS, WIRING DIAGRAM AND PC BOARD LAYOUT

Unit: mm

Outline Dimensions

PCB Layout (Bottom view)

J-legs
SMT type

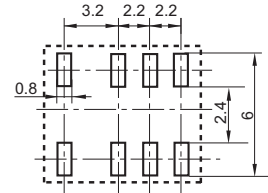
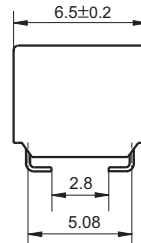
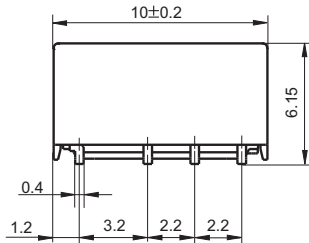

Wiring Diagram
(Bottom view)

Single side stable

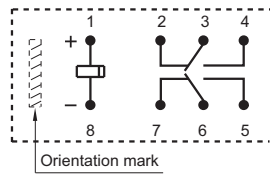

No energized condition

1 coil latching

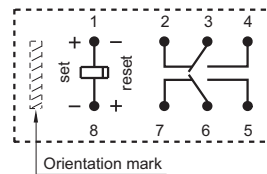

Reset condition

Pin Layout

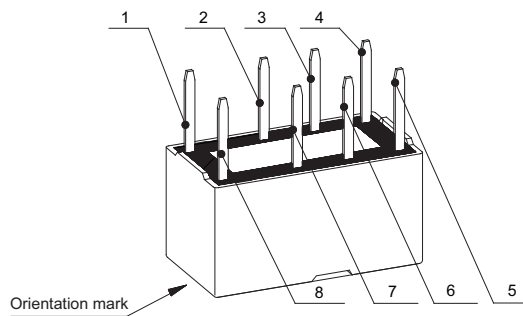

Remark: 1) In case of no tolerance shown in outline dimension: outline dimension $\leq 1\text{mm}$, tolerance should be $\pm 0.2\text{mm}$; outline dimension $> 1\text{mm}$ and $\leq 5\text{mm}$, tolerance should be $\pm 0.3\text{mm}$; outline dimension $> 5\text{mm}$, tolerance should be $\pm 0.4\text{mm}$.

2) The tolerance without indicating for PCB layout is always $\pm 0.1\text{mm}$;

3) The width of the gridding is 2.54mm.

TAPE PACKING

Direction of Relay Insertion

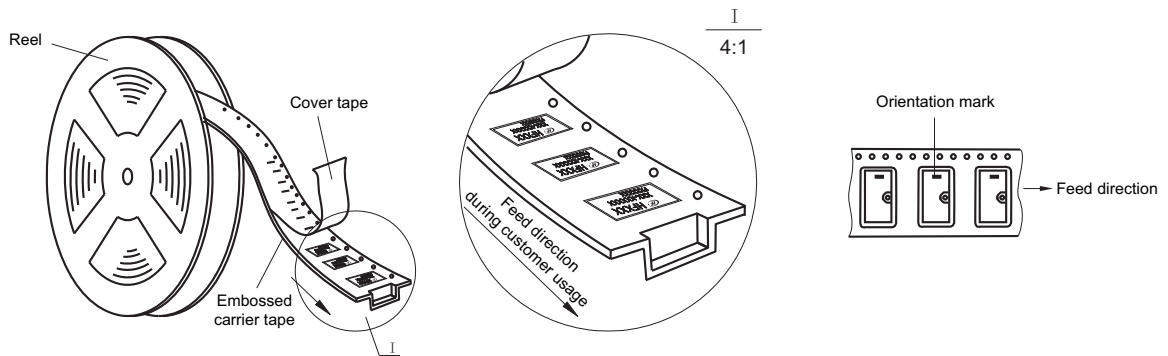

- Notes:**
1. S type/S1 type: 1) Packing: 900pcs/reel, 4 reels/carton.
2) MOQ for reel packing is 900pcs
 2. S3 type: 1) Packing: 850pcs/reel, 4 reels/carton.
2) MOQ for reel packing is 850pcs..

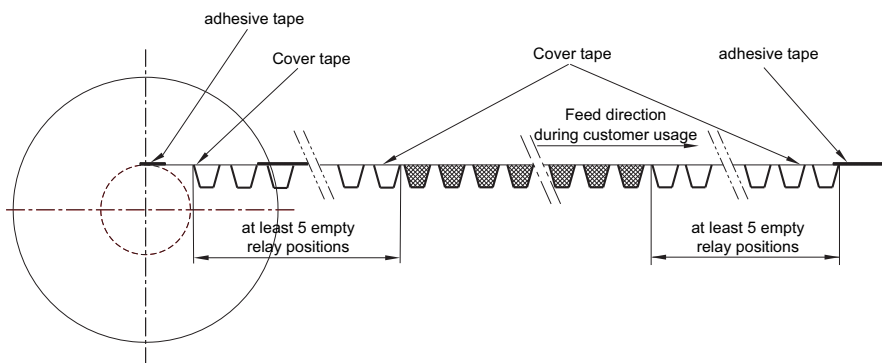

Reel Dimensions

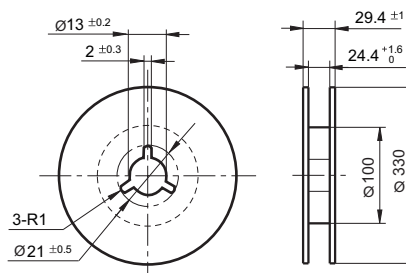

CHARACTERISTIC CURVES

MAXIMUM SWITCHING POWER

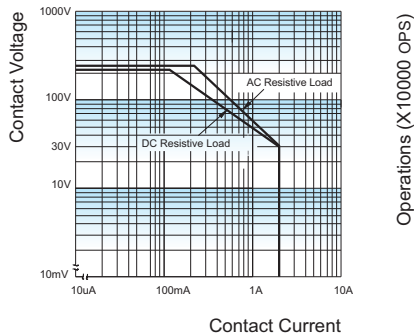

ENDURANCE CURVE

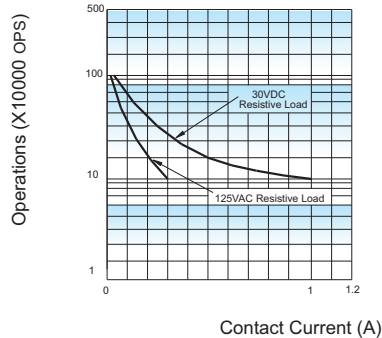

REFLOW WELDING, TEMPERATURE ON PCB BOARD
RECOMMENDED WELDING TEMPERATURE

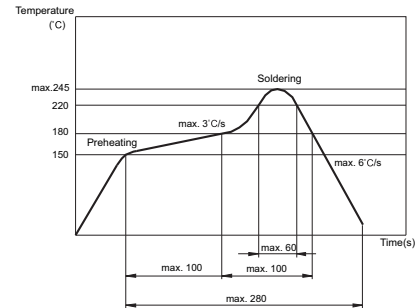

Test conditions:

- Energized with rated voltage
- Resistive load, at 85°C, 1s on 9s off.

Notice

- 1) This relay is highly sensitive polarized relay, if correct polarity is not applied to the coil terminals, the relay does not operate properly.
- 2) To avoid using relays under strong magnetic field which will change the parameters of relays such as pick-up voltage and drop-out voltage.
- 3) Relay is on the "reset" status when being released from stock, with the consideration of shock risen from transit and relay mounting, it should be changed to the "set" status when application(connecting to the power supply). Please reset the relay to "set" or "reset" status on request.
- 4) Energizing coil with rated voltage is basic for normal operation of a relay, please make sure the energized voltage to relay coil have reached the rated voltage. Regarding latching relay, in order to maintain the "set" or "reset" status, impulse width of the rated voltage applied to coil should be more than 5 times of "set" or "reset" time.
- 5) For a monosteady state relay, after the relay is reliably operated, if it needs to be kept under pressure, make sure that the effective value of the voltage is not less than 60% of the rated voltage;
- 6) The relay may be damaged because of falling or when shocking conditions exceed the requirement.
- 7) For SMT products, validation with real application should be done before your series production, if the reflow-soldering temperature curve is out of our recommendation. Generally, two-time reflow-soldering is not recommended for the relay. However, if two-time reflow-soldering is required, a 60-min. interval should be guaranteed and a validation should be done before production.
- 8) Please use wave soldering or manual soldering for straight-in relay. If you need reflow welding, please confirm the feasibility with us.
- 9) Contact is recommended for suitable condition and specifications if water cleaning or surface process is involved in assembling relays on PCB.
- 10) Regarding the plastic sealed relay, we should leave it cooling naturally until below 40°C after welding, then clean it and deal with coating, remarkably the temperature of solvents should also be controlled below 40°C. Please avoid cleaning the relay by ultrasonic, avoid using the solvents like gasoline, Freon, and so on, which would affect the configuration of relay or influence the environment.
- 11) Relays packaged in moisture barrier bags meet MSL-3 requirements. The relays should be stored at ambient conditions of $\leq 30^{\circ}\text{C}$ and $\leq 60\%$ RH after they are removed from their packaging, and should be used within 168 hours. If the relays cannot be used within 168 hours, please repack them or store them in a drying oven at $25^{\circ}\text{C} \pm 5^{\circ}\text{C}$, $\leq 10\%$ RH. Otherwise, relays may be subjected to a soldering test to check their performance, or they may be used after keeping them in an oven for 72 hours at with $50^{\circ}\text{C} \pm 5^{\circ}\text{C}$, $\leq 30\%$ RH.
- 12) When applied with continuous current, the heat from relay coil will age its isolation. Thus, please do not ground connected the coil to reduce electrical erosion if possible. And please provide protection circuit to avoid broken wire and losses.
- 13) Please make sure that there are no silicon-based substances (such as silicon rubber, silicone oil, silicon-based coating agents, silicon fillers, etc.) around the relay, because it will generate silicon-containing volatile gas, which may cause poor contact in case of silicon-containing volatile gas sticking on contact
- 14) About preferable condition of operation, storage and transportation, please refer to "Explanation to terminology and guidelines of relay".
- 15) During the relay pick-up or drop-out processes, there are stages of contact pressure change, contact vibration and unstable contact etc. When the voltage applied to coil is gradually changed, it will lengthen the unstable stage and affect relay endurance. To reduce this influence, please apply step voltage (switching circuit) to relay coil.

Disclaimer

The specification is for reference only. See to "Terminology and Guidelines" for more information. Specifications subject to change without notice. We could not evaluate all the performance and all the parameters for every possible application. Thus the user should be in a right position to choose the suitable product for their own application. If there is any query, please contact Hongfa for the technical service. However, it is the user's responsibility to determine which product should be used only.