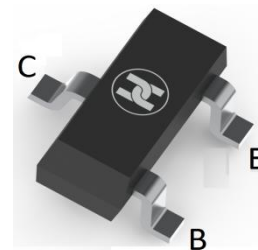
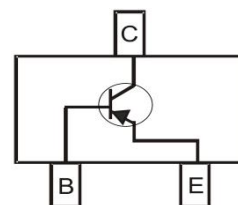

**BIPOLAR TRANSISTOR (PNP)**
**FEATURES**

- High current And High voltage
- Excellent  $h_{FE}$  Linearity
- Low Noise
- Surface Mount device
- Complementary to 2SC1815

**SOT-23**

**MECHANICAL DATA**

- Case: SOT-23
- Case Material: Molded Plastic. UL flammability
- Classification Rating: 94V-0
- Weight: 0.008 grams (approximate)

**MAXIMUM RATINGS ( $T_A = 25^\circ\text{C}$  unless otherwise noted)**

Parameter	Symbol	Value	Unit
Collector-Base Voltage	$V_{CBO}$	-50	V
Collector-Emitter Voltage	$V_{CEO}$	-50	V
Emitter-Base Voltage	$V_{EBO}$	-5	V
Collector Current	$I_C$	-150	mA
Collector Power Dissipation	$P_C$	200	mW
Thermal Resistance From Junction To Ambient	$R_{\theta JA}$	625	$^\circ\text{C}/\text{W}$
Junction Temperature	$T_J$	150	$^\circ\text{C}$
Storage Temperature	$T_{STG}$	-55 ~+150	$^\circ\text{C}$

**ELECTRICAL CHARACTERISTICS ( $T_A = 25^\circ\text{C}$  unless otherwise specified)**

Parameter	Symbol	Min	Typ	Max	Unit	Conditions
Collector-base breakdown voltage	$V_{(BR)CBO}$	-50			V	$I_C = -100\mu\text{A}$ , $I_E = 0$
Collector-emitter breakdown voltage	$V_{(BR)CEO}$	-50			V	$I_C = -0.1\text{mA}$ , $I_B = 0$
Emitter-base breakdown voltage	$V_{(BR)EBO}$	-5			V	$I_E = -100\mu\text{A}$ , $I_C = 0$
Collector cut-off current	$I_{CBO}$			-0.1	$\mu\text{A}$	$V_{CB} = -50\text{V}$ , $I_E = 0$
Collector cut-off current	$I_{CEO}$			-1	$\mu\text{A}$	$V_{CE} = -50\text{V}$ , $I_B = 0$
Emitter cut-off current	$I_{EBO}$			-0.1	$\mu\text{A}$	$V_{EB} = 5\text{V}$ , $I_C = 0$
DC current gain	$h_{FE}$	130		400		$V_{CE} = 6\text{V}$ , $I_C = 2\text{mA}$
Collector-emitter saturation voltage	$V_{CE(sat)}$			-0.3	V	$I_C = -100\text{mA}$ , $I_B = -10\text{mA}$
Base-emitter saturation voltage	$V_{BE(sat)}$			-1	V	$I_C = -100\text{mA}$ , $I_B = -10\text{mA}$
Transition frequency	$f_T$	80			MHz	$V_{CE} = -10\text{V}$ , $I_C = -1\text{mA}$ , $f = 30\text{MHz}$

**CLASSIFICATION OF  $h_{FE}$** 

Rank	L	H
Range	130-200	200-400
Marking	BA	

**BIPOLAR TRANSISTOR (PNP)**

**Typical Characteristics**

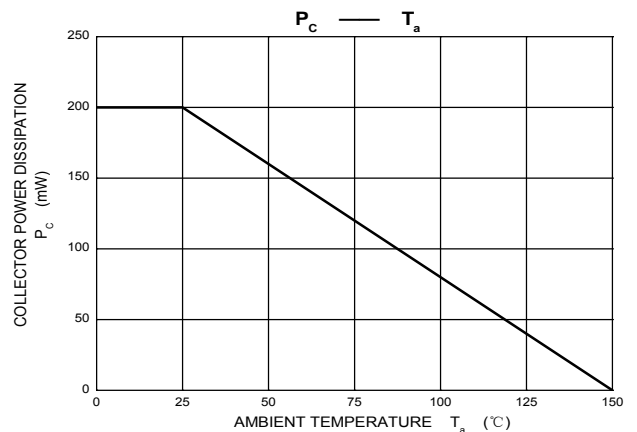
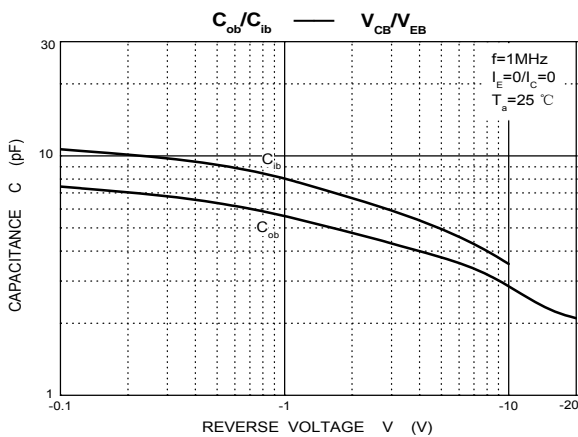
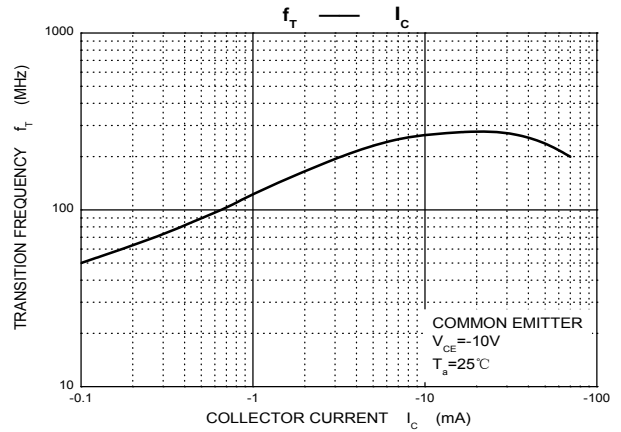
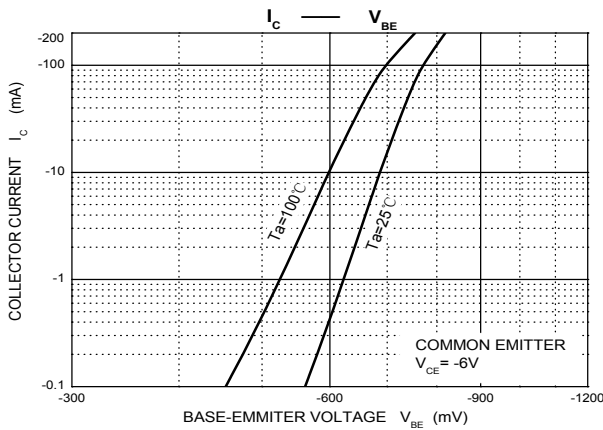
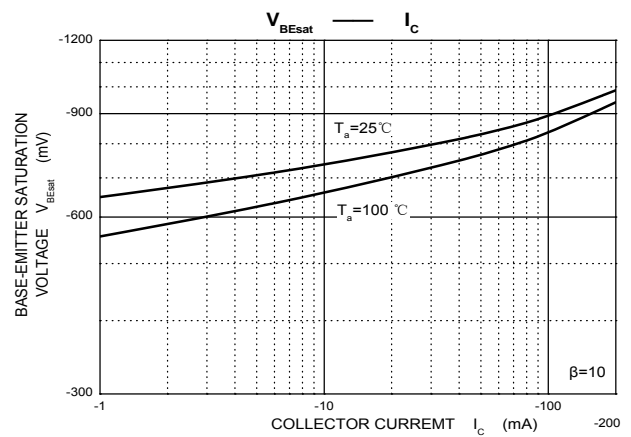
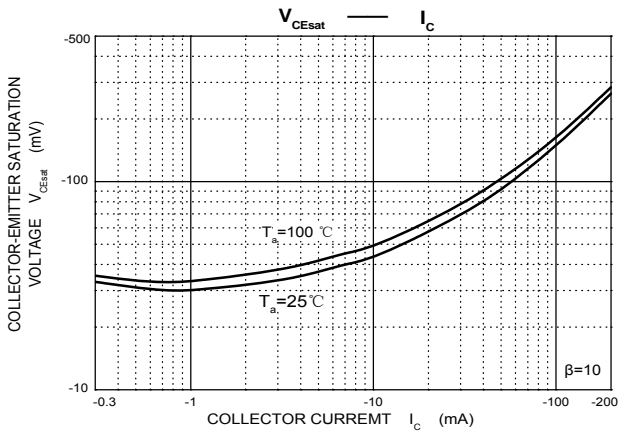
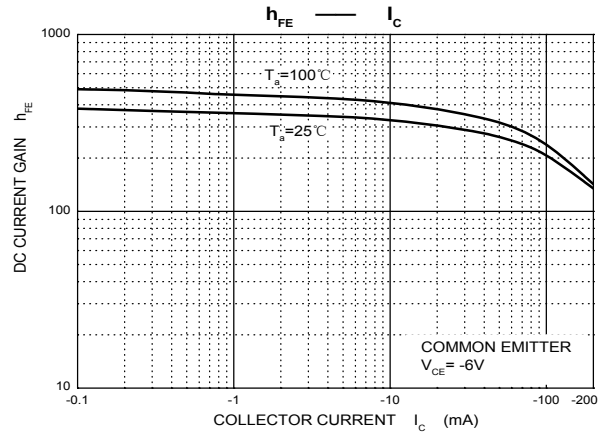
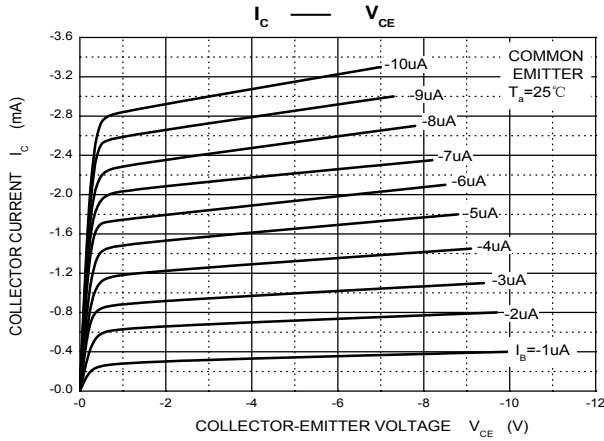

BIPOLAR TRANSISTOR (PNP)

SOT-23 Package Outline Dimensions

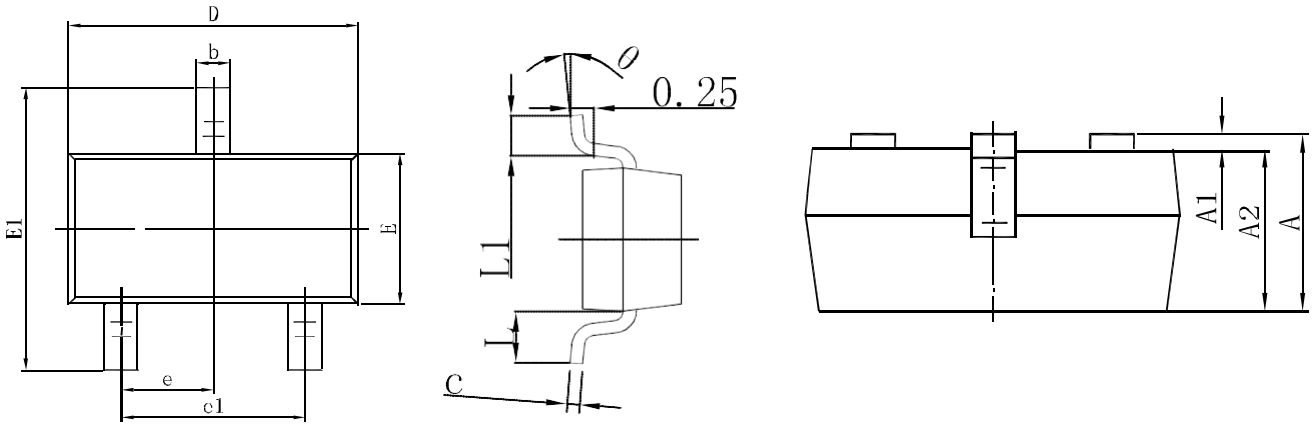

Symbol	Dimensions In Millimeters		Dimensions In Inches	
	Min.	Max.	Min.	Max.
A	0.900	1.150	0.035	0.045
A1	0.000	0.100	0.000	0.004
A2	0.900	1.050	0.035	0.041
b	0.300	0.500	0.012	0.020
c	0.080	0.150	0.003	0.006
D	2.800	3.000	0.110	0.118
E	1.200	1.400	0.047	0.055
E1	2.250	2.550	0.089	0.100
e	0.950 TYP		0.037 TYP	
e1	1.800	2.000	0.071	0.079
L	0.550 REF		0.022 REF	
L1	0.300	0.500	0.012	0.020
θ	0°	8°	0°	8°

SOT-23 Suggested Pad Layout

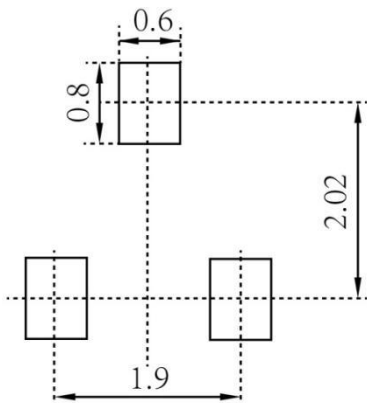

Note:

1. Controlling dimension: in millimeters
2. General tolerance: ±0.05mm
3. The pad layout is for reference purposes only

BIPOLAR TRANSISTOR (PNP)

SOT-23 Tape and Reel

SOT-23 Embossed Carrier Tape

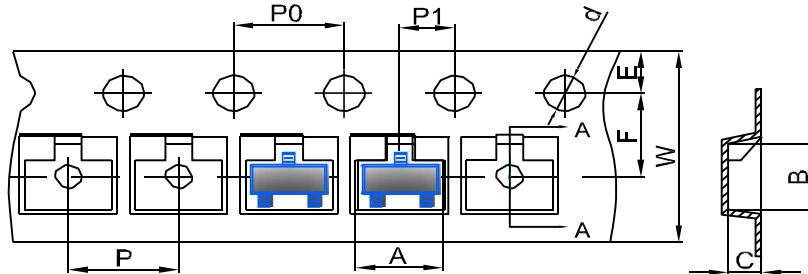

DIMENSIONS ARE IN MILLIMETER										
TYPE	A	B	C	d	E	F	P0	P	P1	W
SOT-23	3.15	2.77	1.22	Ø1.50	1.75	3.50	4.00	4.00	2.00	8.00
TOLERANCE	±0.1	±0.1	±0.1	±0.1	±0.1	±0.1	±0.1	±0.1	±0.1	±0.1

SOT-23 Tape Leader and Trailer

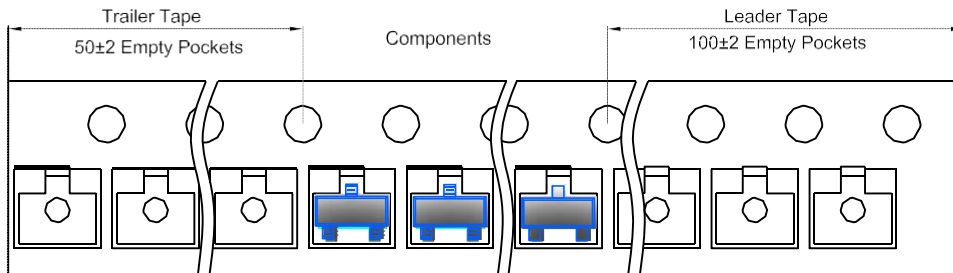

SOT-23 Reel

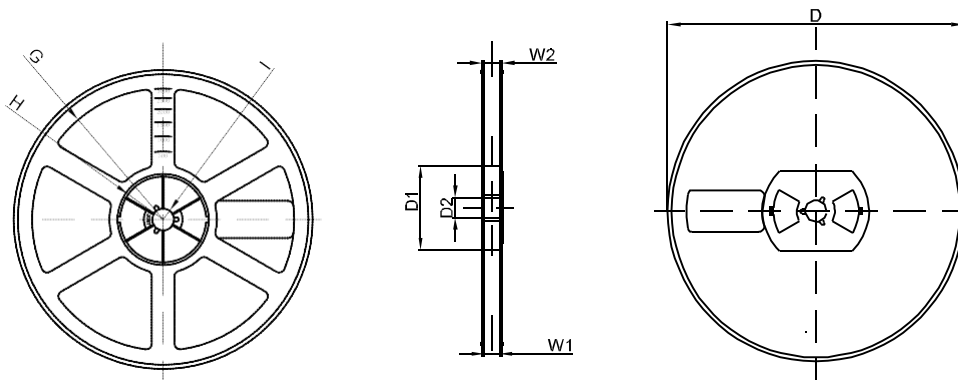

DIMENSIONS ARE IN MILLIMETER								
REEL OPTION	D	D1	D2	G	H	I	W1	W2
7" DIA	Ø178	54.40	13.00	R78	R25.60	R6.50	9.50	12.30
TOLERANCE	±2	±1	±1	±1	±1	±1	±1	±1