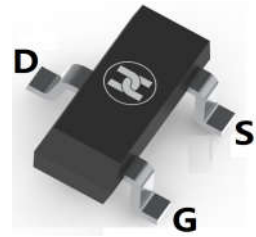
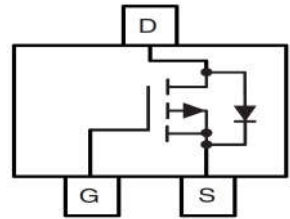

LOW VOLTAGE MOSFET (P-CHANNEL)
FEATURES

- $V_{DS}=-20V, R_{DS(ON)} \leq 100m\Omega @ V_{GS}=-4.5V, I_D=-3A$
- Low on-resistance
- For Low power DC to DC converter and Load switch applications
- Surface Mount device

SOT-23

MECHANICAL DATA

- Case: SOT-23
- Case Material: Molded Plastic. UL flammability
- Classification Rating: 94V-0
- Weight: 0.008 grams (approximate)
- Marking: A1SHB

MAXIMUM RATINGS (T_A = 25°C unless otherwise noted)

Parameter	Symbol	Value	Unit
Drain-source voltage	V_{DS}	-20	V
Gate-source voltage	V_{GS}	± 12	V
Continuous drain current	I_D	-3	A
Pulsed drain current (Note 1)	I_{DM}	-10	A
Power dissipation	P_D	1.25	W
Thermal resistance from Junction to ambient	$R_{\theta JA}$	100	°C/W
Junction temperature	T_J	150	°C
Storage temperature	T_{STG}	-55 ~ +150	°C

ELECTRICAL CHARACTERISTICS (T_A = 25°C unless otherwise specified)

Parameter	Symbol	Min	Typ	Max	Unit	Conditions
Drain-Source breakdown voltage	$V_{(BR)DSS}$	-20			V	$V_{GS}=0V, I_D=-250\mu A$
Zero gate voltage drain current	I_{DSS}			-1	μA	$V_{DS}=-20V, V_{GS}=0V$
Gate-body leakage current	I_{GSS}			± 100	nA	$V_{DS}=0V, V_{GS}=\pm 12V$
Gate-threshold voltage (note 1)	$V_{GS(th)}$	-0.5		-1	V	$V_{DS}=V_{GS}, I_D=-250\mu A$
Drain-source on-resistance (note 1)	$R_{DS(ON)}$		80	100	m Ω	$V_{GS}=-4.5V, I_D=-3A$
			105	135	m Ω	$V_{GS}=-2.5V, I_D=-2A$
Forward transconductance (note 1)	g_{FS}		5		S	$V_{DS}=-5V, I_D=-3A$
Input capacitance	C_{iss}		405		pF	$V_{DS}=-10V, V_{GS}=0V, f=1MHz$
Output capacitance	C_{oss}		75		pF	
Reverse transfer capacitance	C_{rss}		55		pF	
Turn-on delay time	$t_{d(on)}$		11	20	nS	$V_{DD}=-10V, I_D=-3A, V_{GEN}=-4.5V, R_{GEN}=3\Omega$
Turn-on rise time	t_r		35	60	nS	
Turn-off delay time	$t_{d(off)}$		30	50	nS	
Turn-off fall time	t_f		10	20	nS	
Total gate charge	Q_g		5.5	10	nC	$V_{DD}=-10V, V_{GS}=-4.5V, I_D=-3A$
Gate-source charge	Q_{gs}		1.1		nC	
Gate-drain charge	Q_{gd}		1.3		nC	
Diode forward voltage (note 1)	V_{SD}			-1.2	V	$I_S=-0.7A, V_{GS}=0V$
Diode forward current	I_S			-3A	A	$T_C = 25^\circ C$

Note: 1. Pulse test Pulse width $\leq 300 \mu s$ $\leq 2\%$.

LOW VOLTAGE MOSFET (P-CHANNEL)
ELECTRICAL CHARACTERISTICS ($T_A=25^{\circ}\text{C}$ unless otherwise specified)

Parameter	Symbol	Min	Typ	Max	Unit	Conditions
Static						
Drain-source breakdown voltage	V_{DS}	-20			V	$V_{DS}=0V, I_D=-250\mu A$
V_{DS} temperature coefficient	$\Delta V_{DS}/T_J$		-18		mV/ $^{\circ}\text{C}$	$I_D=-250\mu A$
$V_{GS(th)}$ temperature coefficient	$\Delta V_{GS(th)}/T_J$		2.2			
Gate-source threshold voltage	$V_{GS(th)}$	-0.4		-1	V	$V_{DS}=V_{GS}, I_D=-250\mu A$
Gate-source leakage	I_{GSS}			± 100	nA	$V_{DS}=0V, V_{GS}=\pm 8V$
Zero gate voltage drain current	I_{DSS}			-1	μA	$V_{DS}=-20V, V_{GS}=0V$
				-30		$V_{DS}=-20V, V_{GS}=0V, T_J=85^{\circ}\text{C}$
On-state drain current (note 5)	$I_{D(on)}$	-6			A	$V_{DS}\leq -5V, V_{GS}=-4.5V$
Drain-source on-state resistance (note 5)	$R_{DS(on)}$		66	85	m Ω	$V_{GS}=-4.5V, I_D=-3.0A$
			88	115		$V_{GS}=-2.5V, I_D=-1.0A$
Forward transconductance (note 5)	g_{fs}		2.0		S	$V_{DS}=-5V, I_D=-3.0A$
Dynamic (note 6)						
Input capacitance	C_{iss}		405		pF	$V_{DS}=-10V, V_{GS}=0V, f=1\text{MHz}$
Output capacitance	C_{oss}		75			
Reverse transfer capacitance	C_{rss}		55			
Total gate charge	Q_g		5.5	10	nC	$V_{DS}=-10V, V_{GS}=-4.5V, I_D=-3A$
			3.3	6		
Gate-source charge	Q_{gs}		0.7		nC	$V_{DS}=-10V, V_{GS}=-2.5V, I_D=-3A$
Gate-drain charge	Q_{gd}		1.3			
Gate resistance	R_g		6.0		Ω	$f=1\text{MHz}$
Turn-on delay time	$t_{d(on)}$		11	20	ns	$V_{DD}=-10V, R_L=10\Omega, I_D=-1A, V_{GEN}=-4.5V, R_G=1\Omega$
Rise time	t_r		35	60		
Turn-off delay time	$t_{d(off)}$		30	50		
Fall time	t_f		10	20		
Drain-source body diode characteristics						
Continuous source-drain diode current	I_S			-1.3	A	$T_C=25^{\circ}\text{C}$
Pulse diode forward current (Note 5)	I_{SM}			-10		
Body diode voltage	V_{SD}		-0.7	-1.3	V	$I_S=-0.7A$
Body diode reverse recovery time	t_{rr}		30	50	ns	$I_F=-3.0A, di/dt=100A/\mu s, T_J=25^{\circ}\text{C}$
Body diode reverse recovery charge	Q_{rr}		25	50	nC	
Reverse recovery fall time	t_a		15		ns	
Reverse recovery rise time	t_b		15			

Note:

 5. Pulse test : pulse width $\leq 300\mu s$, duty cycle $\leq 2\%$.

6. Guaranteed by design, not subject to production testing.

LOW VOLTAGE MOSFET (P-CHANNEL)

TYPICAL CHARACTERISTICS

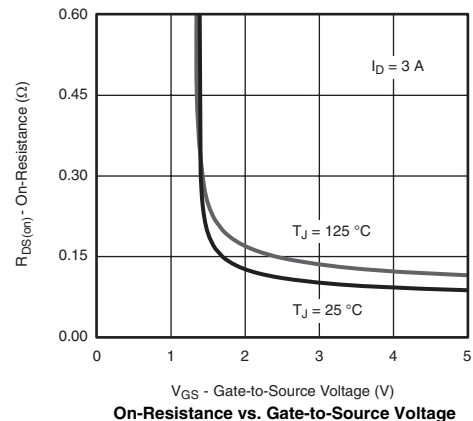
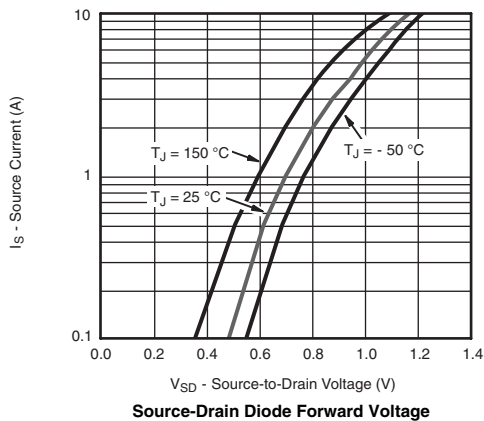
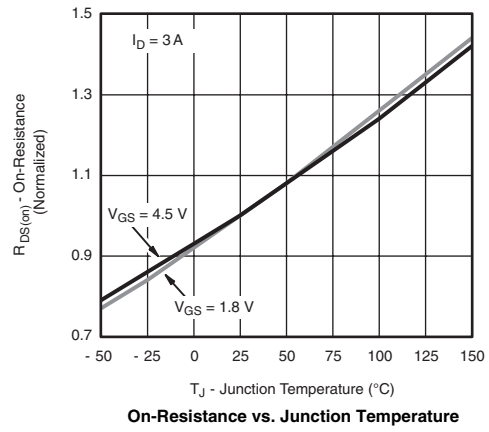
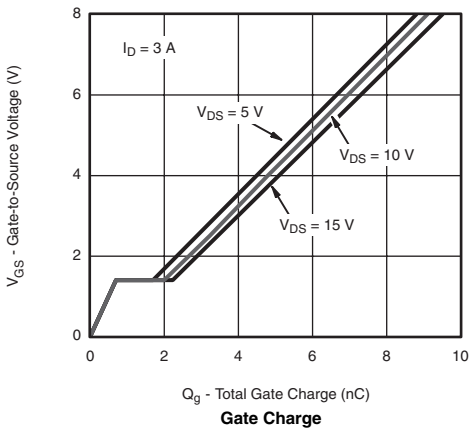
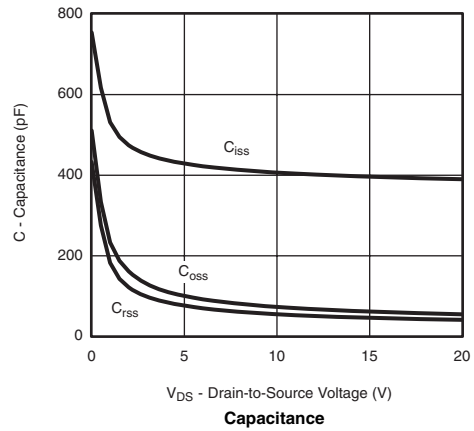
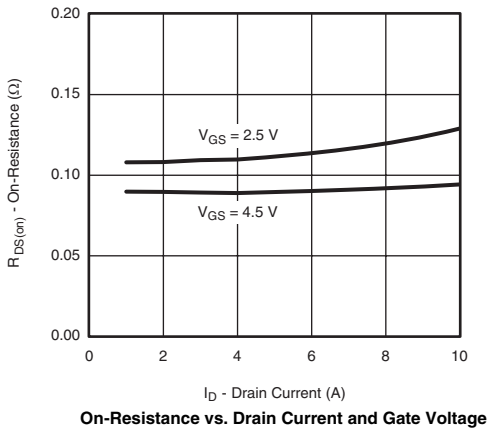
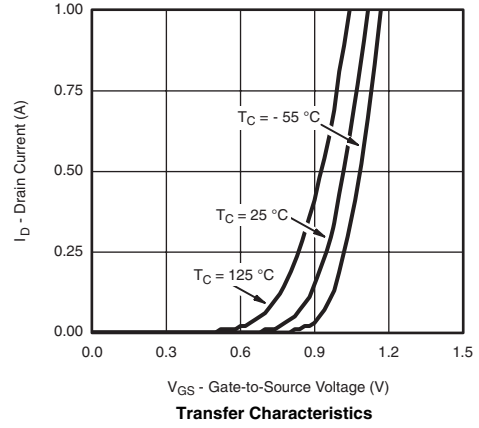
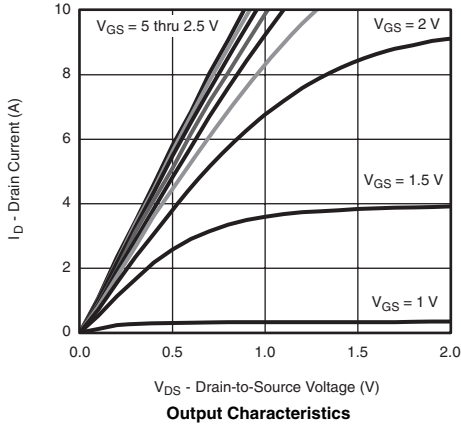

LOW VOLTAGE MOSFET (P-CHANNEL)

TYPICAL CHARACTERISTICS (continued)

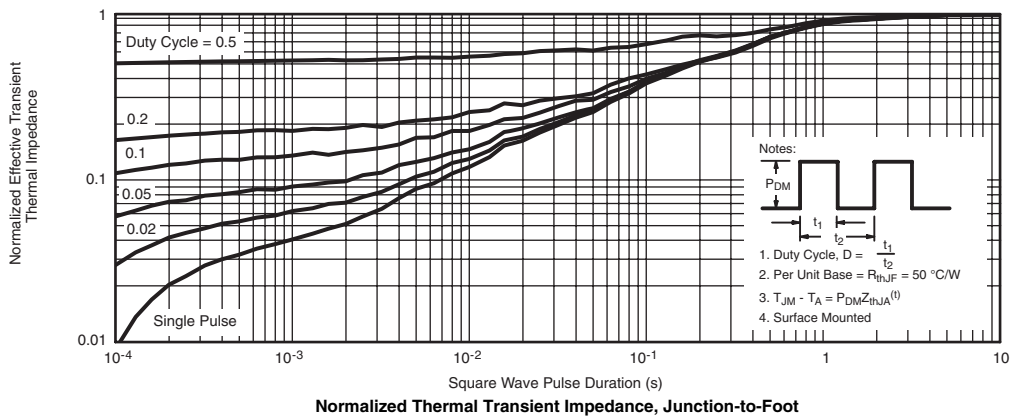
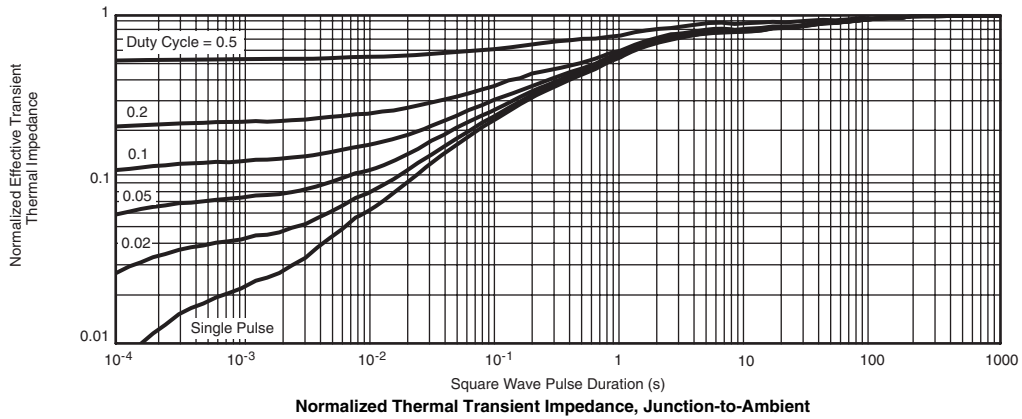
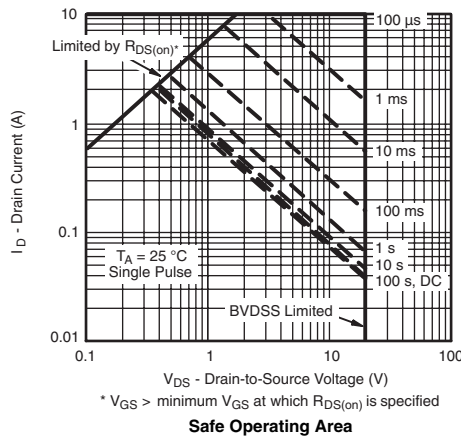
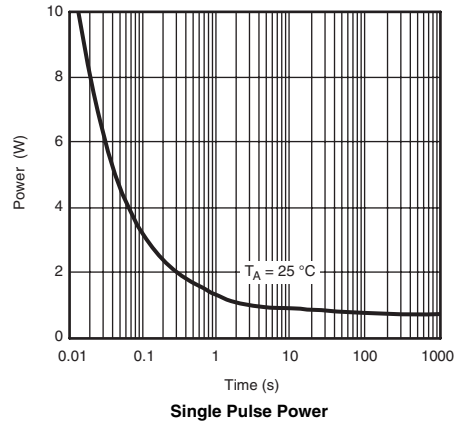
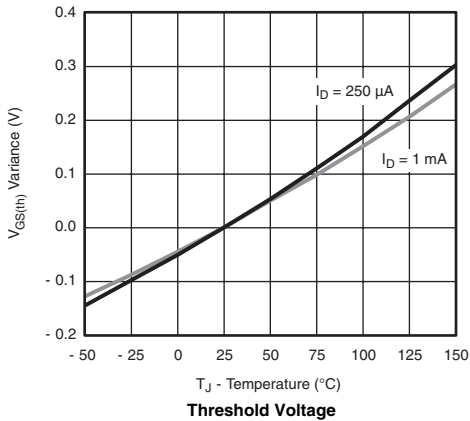

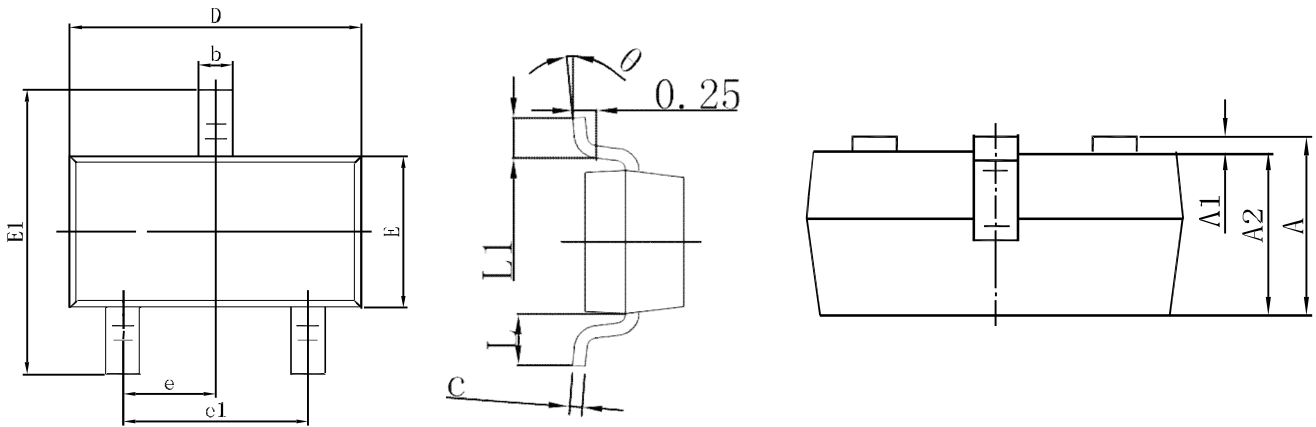
LOW VOLTAGE MOSFET (P-CHANNEL)
SOT-23 PACKAGE OUTLINE DIMENSIONS

Symbol	Dimensions In Millimeters		Dimensions In Inches	
	Min.	Max.	Min.	Max.
A	0.900	1.150	0.035	0.045
A1	0.000	0.100	0.000	0.004
A2	0.900	1.050	0.035	0.041
b	0.300	0.500	0.012	0.020
c	0.080	0.150	0.003	0.006
D	2.800	3.000	0.110	0.118
E	1.200	1.400	0.047	0.055
E1	2.250	2.550	0.089	0.100
e	0.950 TYP		0.037 TYP	
e1	1.800	2.000	0.071	0.079
L	0.550 REF		0.022 REF	
L1	0.300	0.500	0.012	0.020
θ	0°	8°	0°	8°

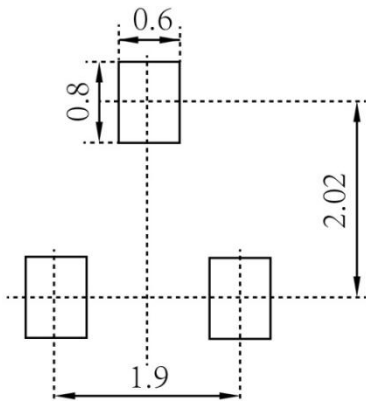
SOT-23 SUGGESTED PAD LAYOUT

Note:

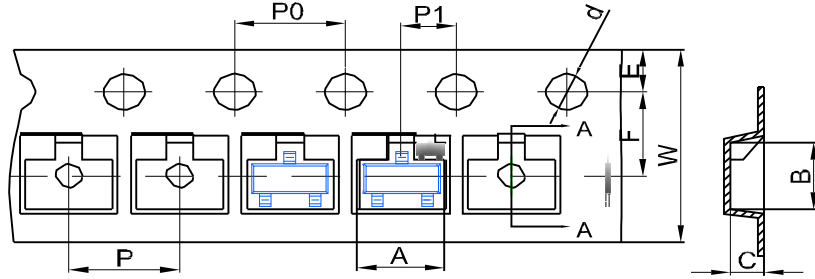
1. Controlling dimension: in millimeters
2. General tolerance: $\pm 0.05\text{mm}$
3. The pad layout is for reference purposes only

LOW VOLTAGE MOSFET (P-CHANNEL)
SOT-23 TAPE AND REEL
SOT-23 Embossed Carrier Tape

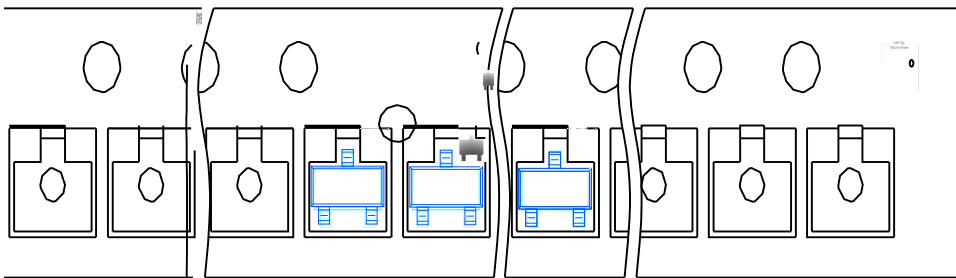
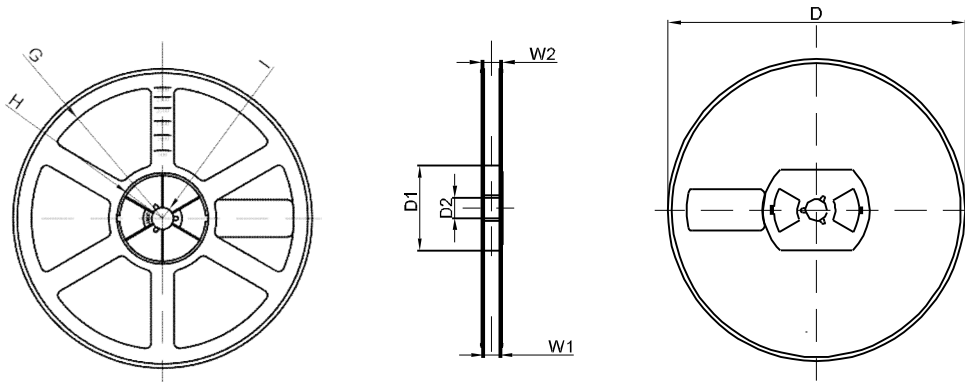
DIMENSIONS ARE IN MILLIMETER										
TYPE	A	B	C	d	E	F	P0	P	P1	W
SOT-23	3.15	2.77	1.22	Ø1.50	1.75	3.50	4.00	4.00	2.00	8.00
TOLERANCE	±0.1	±0.1	±0.1	±0.1	±0.1	±0.1	±0.1	±0.1	±0.1	±0.1

SOT-23 Tape Leader and Trailer

SOT-23 Reel

DIMENSIONS ARE IN MILLIMETER								
REEL OPTION	D	D1	D2	G	H	I	W1	W2
7" DIA	Ø178	54.40	13.00	R78	R25.60	R6.50	9.50	12.30
TOLERANCE	±2	±1	±1	±1	±1	±1	±1	±1