

MC 1,5/12-STF-3,81 - PCB connector



1827800

<https://www.phoenixcontact.com/us/products/1827800>

Please be informed that the data shown in this PDF document is generated from our Online Catalog. Please find the complete data in the user documentation. Our General Terms of Use for Downloads are valid.

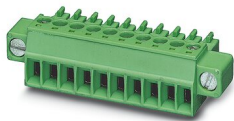

PCB connector, nominal cross section: 1.5 mm², color: green, nominal current: 8 A, rated voltage (III/2): 160 V, contact surface: Tin, type of contact: Female connector, number of potentials: 12, number of rows: 1, number of positions: 12, number of connections: 12, product range: MC 1,5/..-STF, pitch: 3.81 mm, connection method: Screw connection with tension sleeve, screw head form: L Slotted, conductor/PCB connection direction: 0 °, plug-in system: COMBICON MC 1,5, locking: Screw locking, mounting: Screw flange, type of packaging: packed in cardboard

Your advantages

- Well-known connection principle allows worldwide use
- Low temperature rise, thanks to maximum contact force
- Allows connection of two conductors
- Screwable flange for superior mechanical stability

Commercial Data

Item number	1827800
Packing unit	1 pc
Minimum order quantity	1 pc
Sales Key	AA02
Product Key	AABABB
Catalog Page	Page 191 (C-1-2013)
GTIN	4017918050269
Weight per Piece (including packing)	9.971 g
Weight per Piece (excluding packing)	9.323 g
Customs tariff number	85366990
Country of origin	US

MC 1,5/12-STF-3,81 - PCB connector



1827800

<https://www.phoenixcontact.com/us/products/1827800>

Technical Data

Product properties

Type	Standard
Product line	COMBICON Connectors S
Product type	PCB plug
Product family	MC 1,5/...-STF
Number of positions	12
Pitch	3.81 mm
Number of connections	12
Number of rows	1
Mounting flange	Screw flange
Number of potentials	12

Electrical properties

Nominal current I_N	8 A
Nominal voltage U_N	160 V
Degree of pollution	3
Contact resistance	1.3 m Ω
Rated voltage (III/3)	160 V
Rated surge voltage (III/3)	2.5 kV
Rated voltage (III/2)	160 V
Rated surge voltage (III/2)	2.5 kV
Rated voltage (II/2)	320 V
Rated surge voltage (II/2)	2.5 kV

Connection data

Connection technology

Type	Standard
Connector system	COMBICON MC 1,5
Nominal cross section	1.5 mm ²
Type of contact	Female connector

Interlock

Locking type	Screw locking
Mounting flange	Screw flange
Tightening torque	0.3 Nm

Conductor connection

Connection method	Screw connection with tension sleeve
Conductor/PCB connection direction	0 °
Conductor cross section solid	0.14 mm ² ... 1.5 mm ²
Conductor cross section flexible	0.14 mm ² ... 1.5 mm ²
Conductor cross section AWG	28 ... 16

MC 1,5/12-STF-3,81 - PCB connector



1827800

<https://www.phoenixcontact.com/us/products/1827800>

Conductor cross section flexible, with ferrule without plastic sleeve	0.25 mm ² ... 1.5 mm ²
Conductor cross section, flexible, with ferrule, with plastic sleeve	0.25 mm ² ... 0.75 mm ²
2 conductors with same cross section, solid	0.08 mm ² ... 0.5 mm ²
2 conductors with same cross section, flexible	0.08 mm ² ... 0.75 mm ²
2 conductors with same cross section, flexible, with ferrule without plastic sleeve	0.25 mm ² ... 0.34 mm ²
2 conductors with the same cross section, flexible, with TWIN ferrule with plastic sleeve	0.5 mm ² ... 0.5 mm ²
Cylindrical gauge a x b / diameter	2.4 mm x 1.5 mm / 1.6 mm
Stripping length	7 mm
Tightening torque	0.22 Nm ... 0.25 Nm

Material specifications

Material data - contact

Note	WEEE/RoHS-compliant, free of whiskers according to IEC 60068-2-82/JEDEC JESD 201
Contact material	Cu alloy
Surface characteristics	hot-dip tin-plated
Metal surface terminal point (top layer)	Tin (4 - 8 µm Sn)
Metal surface contact area (top layer)	Tin (4 - 8 µm Sn)

Material data - housing

Color (Housing)	green (6021)
Insulating material	PA
Insulating material group	I
CTI according to IEC 60112	600
Flammability rating according to UL 94	V0
Glow wire flammability index GWFI according to EN 60695-2-12	850
Glow wire ignition temperature GWIT according to EN 60695-2-13	775
Temperature for the ball pressure test according to EN 60695-10-2	125 °C

Material data – actuating element

Color ()	()
-----------	-----

Dimensions

Dimensional drawing	
Pitch	3.81 mm
Width [w]	56.11 mm
Height [h]	11.1 mm

MC 1,5/12-STF-3,81 - PCB connector



1827800

<https://www.phoenixcontact.com/us/products/1827800>

Length [l]	16.1 mm
------------	---------

Mounting

Drive form screw head	Slotted (L)
Drive form screw head	Slotted (L)

Flange

Tightening torque	0.3 Nm
-------------------	--------

Mechanical tests

Test for conductor damage and slackening

Specification	IEC 60999-1:1999-11
Result	Test passed

Pull-out test

Specification	IEC 60999-1:1999-11
Conductor cross section/conductor type/tractive force setpoint/actual value	0.14 mm ² / solid / > 7 N
	0.14 mm ² / flexible / > 7 N
	1.5 mm ² / solid / > 40 N
	1.5 mm ² / flexible / > 40 N

Insertion and withdrawal forces

Result	Test passed
No. of cycles	25
Insertion strength per pos. approx.	6 N
Withdraw strength per pos. approx.	4 N

Torque test

Specification	IEC 60999-1:1999-11
---------------	---------------------

Contact holder in insert

Specification	IEC 60512-15-1:2008-05
Contact holder in insert Requirements >20 N	Test passed

Resistance of inscriptions

Specification	IEC 60068-2-70:1995-12
Result	Test passed

Polarization and coding

Specification	IEC 60512-13-5:2006-02
Result	Test passed

Visual inspection

Specification	IEC 60512-1-1:2002-02
Result	Test passed

Dimension check

MC 1,5/12-STF-3,81 - PCB connector



1827800

<https://www.phoenixcontact.com/us/products/1827800>

Specification	IEC 60512-1-2:2002-02
Result	Test passed

Environmental and real-life conditions

Vibration test

Specification	IEC 60068-2-6:2007-12
Frequency	10 - 150 - 10 Hz
Sweep speed	1 octave/min
Amplitude	0.35 mm (10 Hz ... 60.1 Hz)
Sweep speed	5g (60.1 Hz ... 150 Hz)
Test duration per axis	2.5 h

Durability test

Specification	IEC 60512-9-1:2010-03
Impulse withstand voltage at sea level	2.95 kV
Contact resistance R ₁	1.3 mΩ
Contact resistance R ₂	1.5 mΩ
Insertion/withdrawal cycles	25
Insulation resistance, neighboring positions	> 5 MΩ

Climatic test

Specification	ISO 6988:1985-02
Corrosive stress	0.2 dm ³ SO ₂ on 300 dm ³ /40 °C/1 cycle
Thermal stress	100 °C/168 h
Power-frequency withstand voltage	1.39 kV

Shocks

Specification	IEC 60068-2-27:2008-02
Pulse shape	Semi-sinusoidal
Acceleration	30g
Shock duration	18 ms
Test directions	X-, Y- and Z-axis (pos. and neg.)

Ambient conditions

Ambient temperature (operation)	-40 °C ... 100 °C (dependent on the derating curve)
Ambient temperature (storage/transport)	-40 °C ... 70 °C
Relative humidity (storage/transport)	30 % ... 70 %
Ambient temperature (assembly)	-5 °C ... 100 °C

Electrical tests

Thermal test | Test group C

Specification	IEC 60512-5-1:2002-02
Tested number of positions	20

Insulation resistance

MC 1,5/12-STF-3,81 - PCB connector



1827800

<https://www.phoenixcontact.com/us/products/1827800>

Specification	IEC 60512-3-1:2002-02
Insulation resistance, neighboring positions	> 5 MΩ

Air clearances and creepage distances |

Specification	IEC 60664-1:2007-04
Insulating material group	I
Comparative tracking index (IEC 60112)	CTI 600
Rated insulation voltage (III/3)	160 V
Rated surge voltage (III/3)	2.5 kV
minimum clearance value - non-homogenous field (III/3)	1.5 mm
minimum creepage distance (III/3)	2 mm
Note on connection cross section	With connected conductor 1.5 mm ² (solid).
Rated insulation voltage (III/2)	160 V
Rated surge voltage (III/2)	2.5 kV
minimum clearance value - non-homogenous field (III/2)	1.5 mm
minimum creepage distance (III/2)	1.5 mm
Rated insulation voltage (II/2)	320 V
Rated surge voltage (II/2)	2.5 kV
minimum clearance value - non-homogenous field (II/2)	1.5 mm
minimum creepage distance (II/2)	1.6 mm

Packaging specifications

Type of packaging	packed in cardboard
-------------------	---------------------

MC 1,5/12-STF-3,81 - PCB connector



1827800

<https://www.phoenixcontact.com/us/products/1827800>

Drawings

Diagram

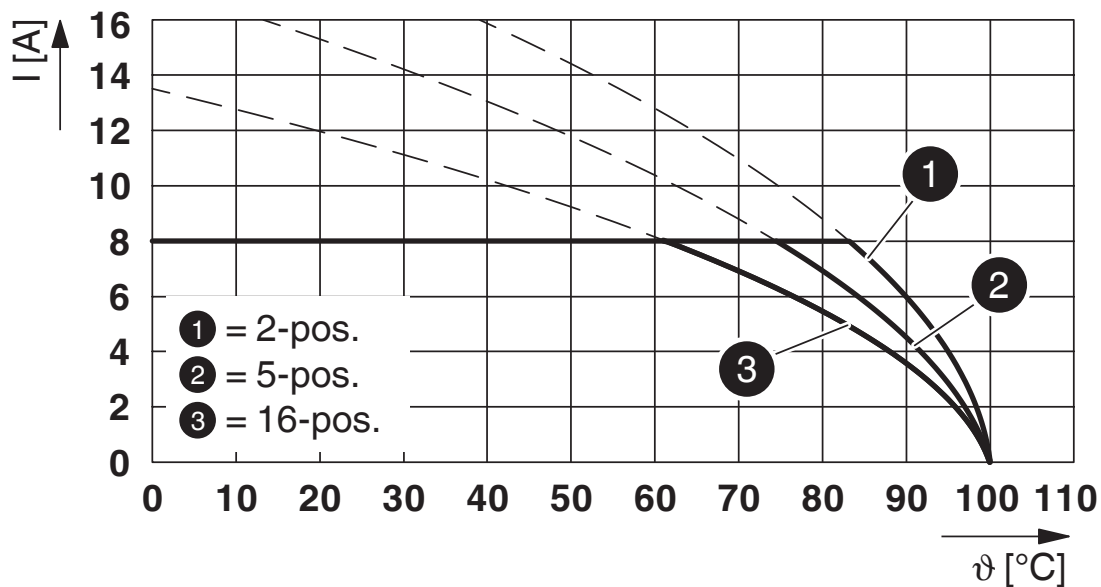

Type: MC 1,5/...-STF-3,81 with MCD 1,5/...-GF-3,81

Diagram

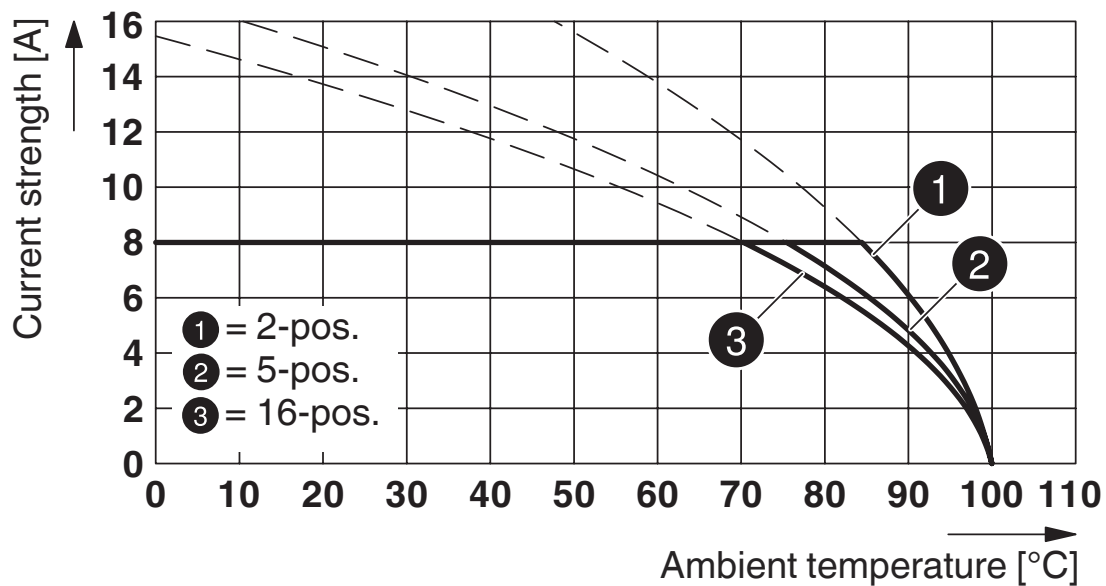

Type: MC 1,5/...-STF-3,81 with IMC 1,5/...-STGF-3,81

MC 1,5/12-STF-3,81 - PCB connector



1827800

<https://www.phoenixcontact.com/us/products/1827800>

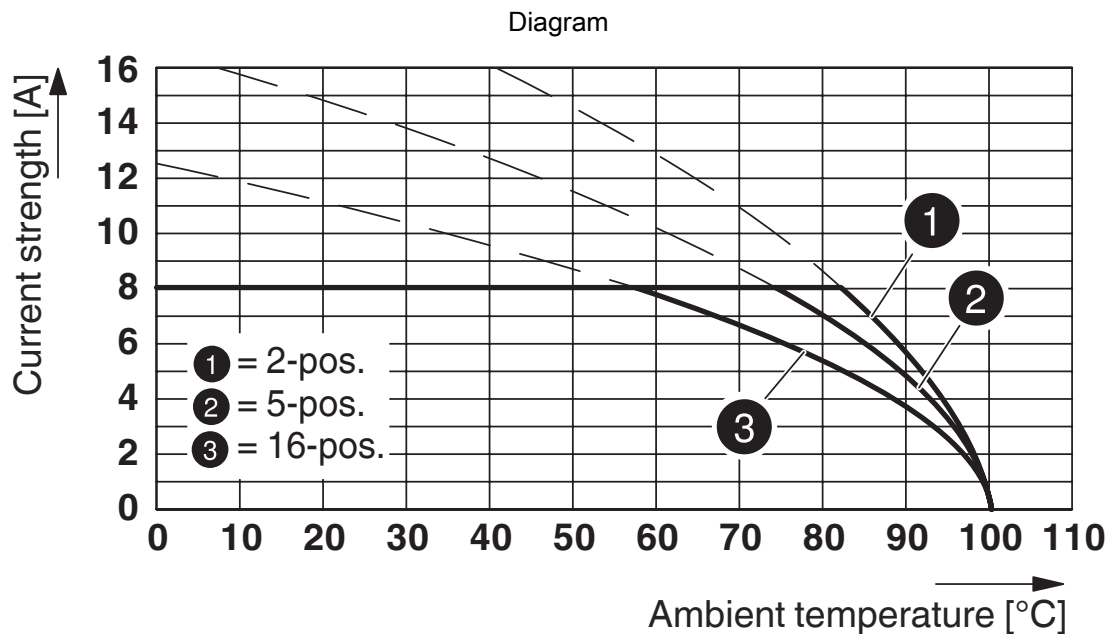

Type: MC 1,5/...-STF-3,81 with MCD 1,5/...-G1F-3,81

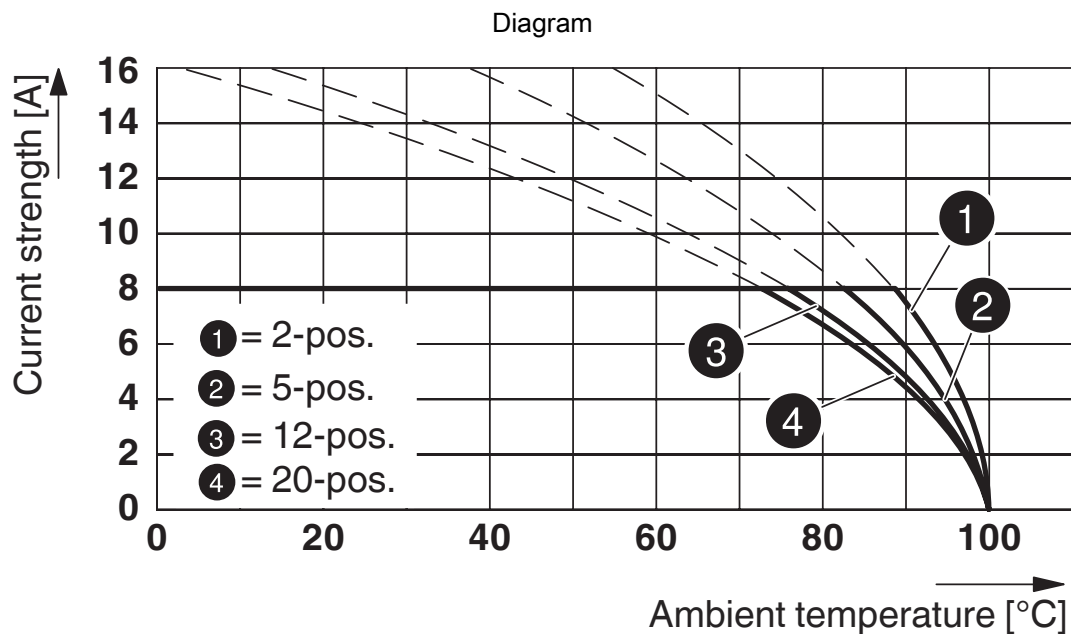

Type: MC 1,5/...-STF-3,81 with MCV 1,5/...-GF-3,81

MC 1,5/12-STF-3,81 - PCB connector



1827800

<https://www.phoenixcontact.com/us/products/1827800>

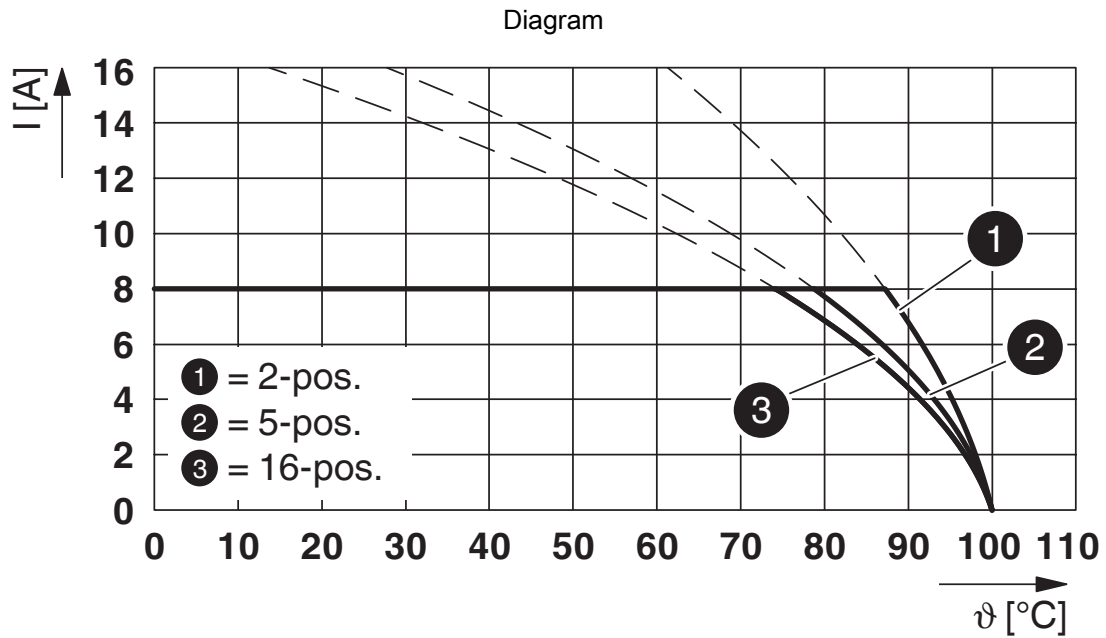

Type: MC 1,5/...-STF-3,81 with SMC 1,5/...-GF-3,81

Dimensional drawing

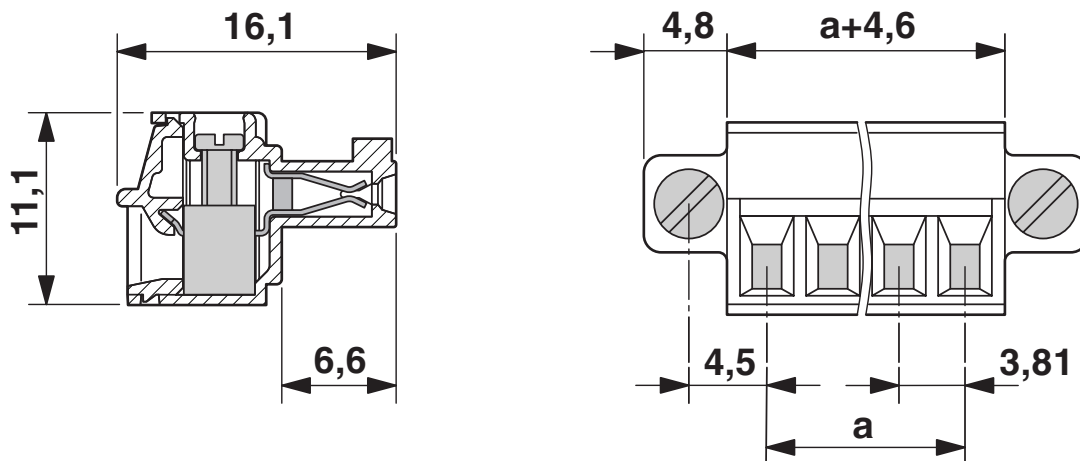

MC 1,5/12-STF-3,81 - PCB connector



1827800

<https://www.phoenixcontact.com/us/products/1827800>

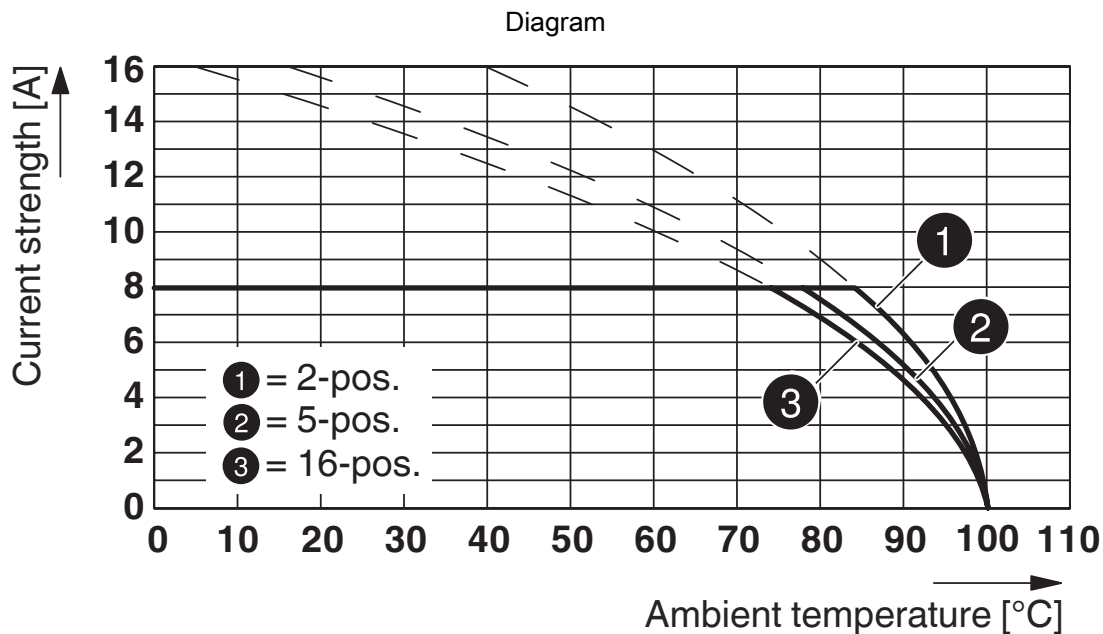

Type: MC 1,5/...-STF-3,81 with DFK-MC 1,5/...-GF-3,81 (with solder connection)

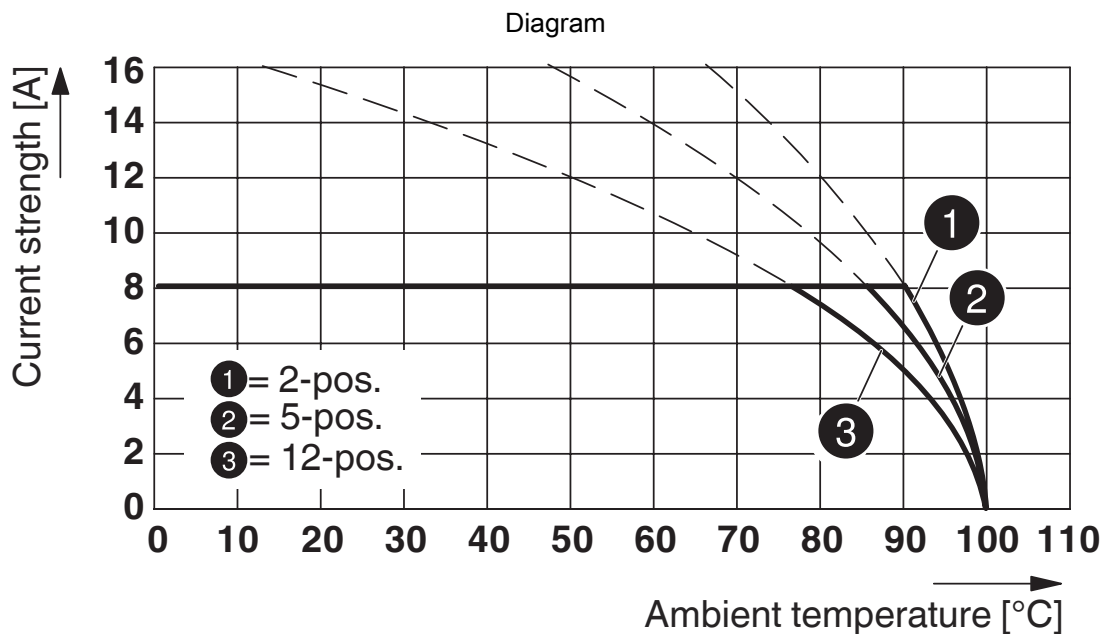

Type: MC 1,5/...-STF-3,81 with MCV 1,5/...-GF-3,81 P26 THR

MC 1,5/12-STF-3,81 - PCB connector



1827800

<https://www.phoenixcontact.com/us/products/1827800>

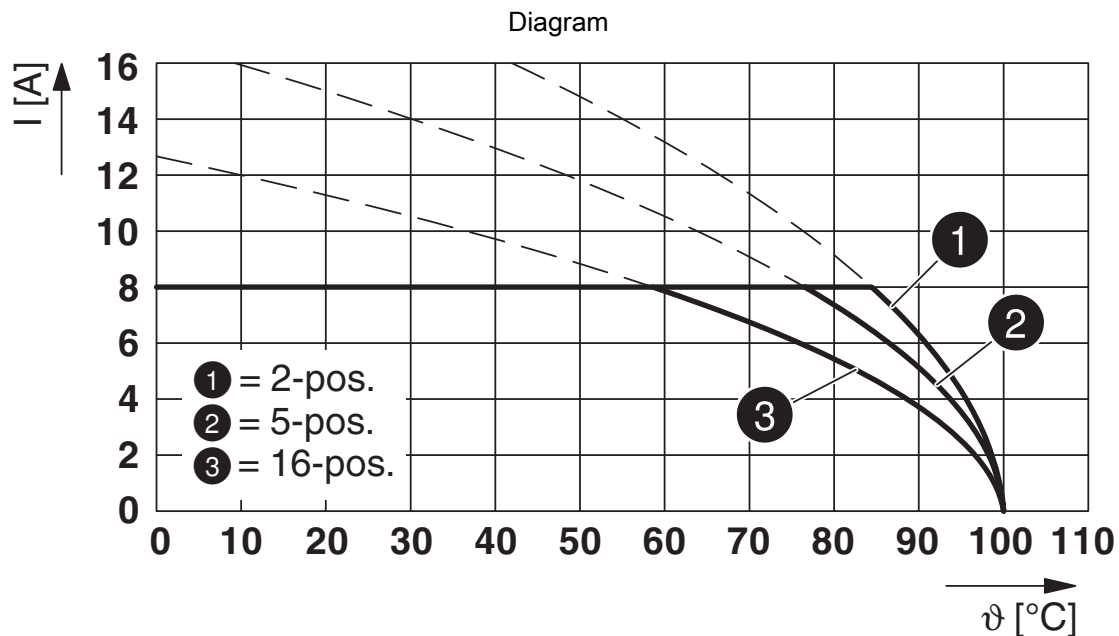

Type: MC 1,5/...-STF-3,81 with MCDV 1,5/...-GF-3,81

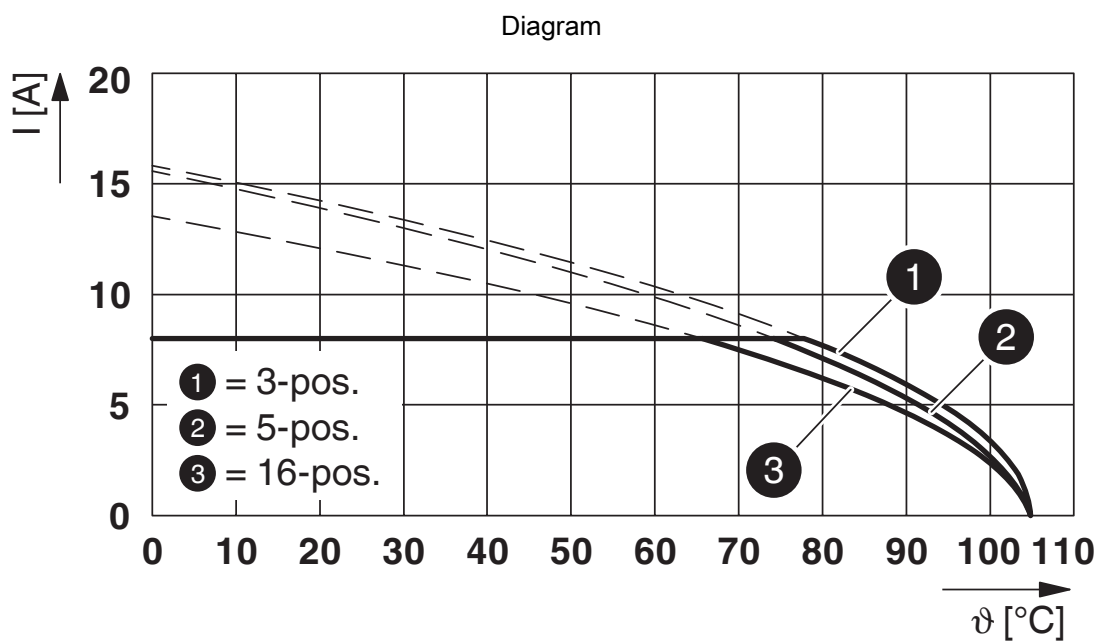

Type: MC 1,5/...-STF-3,81 with MCVK 1,5/...-GF-3,81

MC 1,5/12-STF-3,81 - PCB connector



1827800

<https://www.phoenixcontact.com/us/products/1827800>

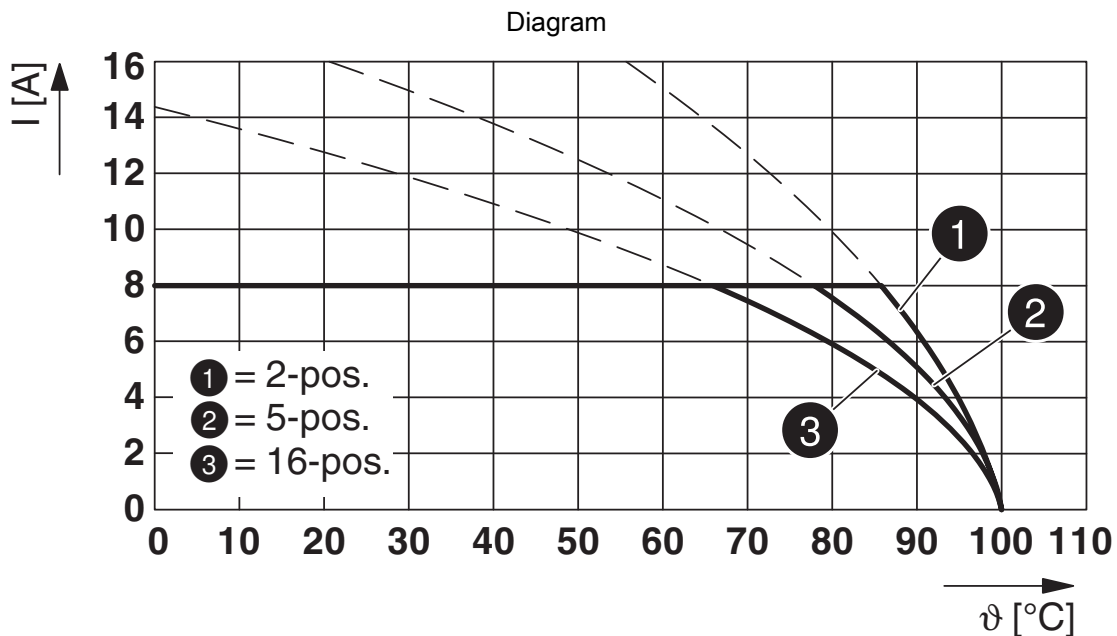

Type: MC 1,5/...-STF-3,81 with MCDV 1,5/...-G1F-3,81

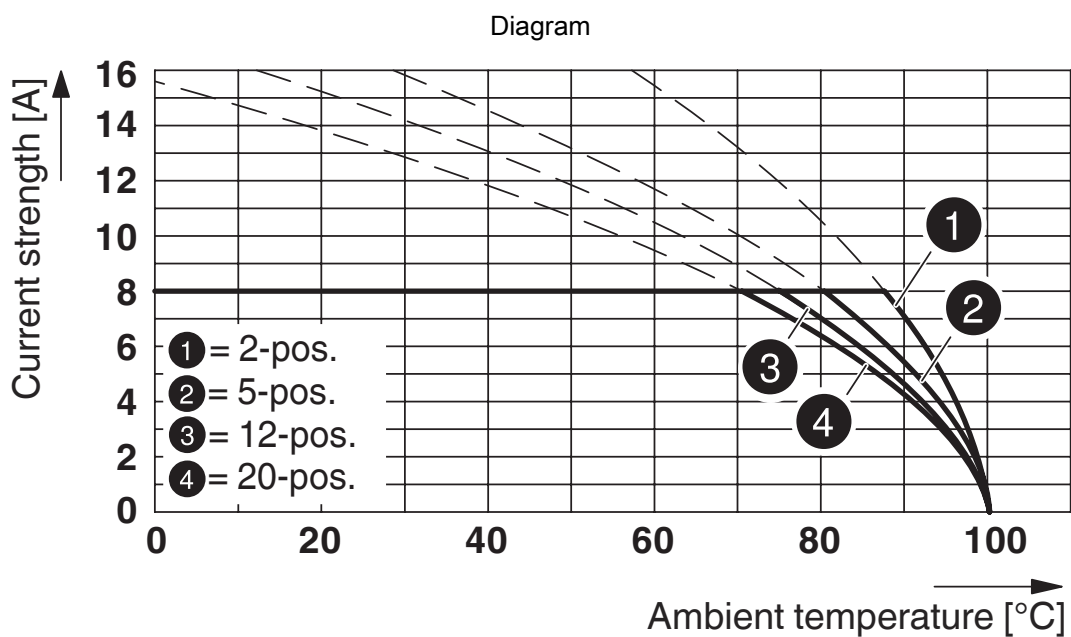

Type: MC 1,5/...-STF-3,81 with MC 1,5/...-GF-3,81

MC 1,5/12-STF-3,81 - PCB connector



1827800

<https://www.phoenixcontact.com/us/products/1827800>

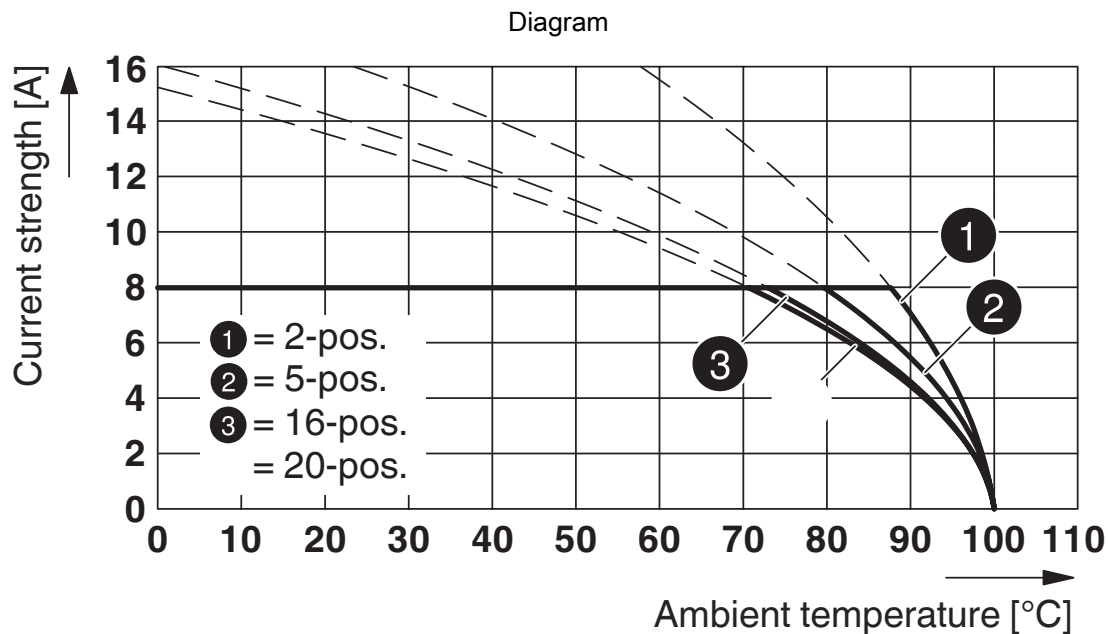

Type: MC 1,5/...-STF-3,81 with MC 1,5/...-GF-3,81 P26THR

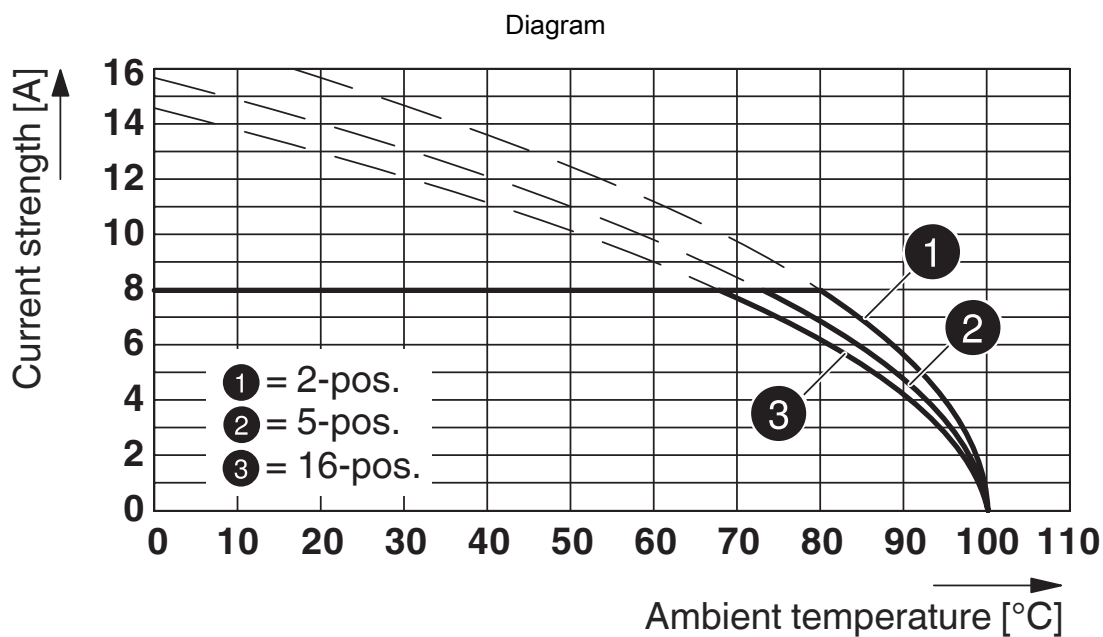

Type: MC 1,5/...-STF-3,81 with DFK-MC 1,5/...-GF-3,81 (with flat plug)

MC 1,5/12-STF-3,81 - PCB connector

1827800

<https://www.phoenixcontact.com/us/products/1827800>



Accessories

SK 3,81/2,8:FORTL.ZAHLEN - Marker card

0804109

<https://www.phoenixcontact.com/us/products/0804109>

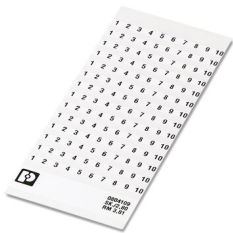

Marker card, white, labeled, horizontal: consecutive numbers 1 ... 10, 11 ... 20, etc. up to 91 ... (99)100, mounting type: adhesive, for terminal block width: 3.81 mm, lettering field size: 3.81 x 2.8 mm

B-STIFT - Marker pen

1051993

<https://www.phoenixcontact.com/us/products/1051993>



Marker pen, for manual labeling of unprinted Zack strips, smear-proof and waterproof, line thickness 0.5 mm

MC 1,5/12-STF-3,81 - PCB connector

1827800

<https://www.phoenixcontact.com/us/products/1827800>



KGG-MC 1,5/12 - Cable housing

1834440

<https://www.phoenixcontact.com/us/products/1834440>



Cable housing, pitch: 3.81 mm, number of positions: 12, dimension a: 48.11 mm, color: green

SZS 0,4X2,5 VDE - Screwdriver

1205037

<https://www.phoenixcontact.com/us/products/1205037>



Screwdriver, slot-headed, VDE insulated, size: 0.4 x 2.5 x 80 mm, 2-component grip, with non-slip grip

MC 1,5/12-STF-3,81 - PCB connector

1827800

<https://www.phoenixcontact.com/us/products/1827800>



EBPL 2-3,81 - Insertion bridge

1733495

<https://www.phoenixcontact.com/us/products/1733495>

Insertion bridge for plugs featuring a screw connection with a 3.81 mm pitch



EBPL 3-3,81 - Insertion bridge

1733505

<https://www.phoenixcontact.com/us/products/1733505>

Insertion bridge for plugs featuring a screw connection with a 3.81 mm pitch



MC 1,5/12-STF-3,81 - PCB connector

1827800

<https://www.phoenixcontact.com/us/products/1827800>



EBPL 4-3,81 - Insertion bridge

1733518

<https://www.phoenixcontact.com/us/products/1733518>

Insertion bridge for plugs featuring a screw connection with a 3.81 mm pitch



MCV 1,5/12-GF-3,81 P14 THR - PCB header

1707311

<https://www.phoenixcontact.com/us/products/1707311>

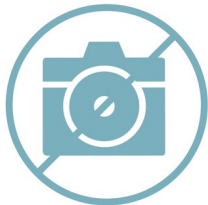

PCB headers, nominal cross section: 1.5 mm², color: black, nominal current: 8 A, rated voltage (III/2): 160 V, contact surface: Tin, type of contact: Male connector, number of potentials: 12, number of rows: 1, number of positions: 12, number of connections: 12, product range: MCV 1,5/..-GF-THR, pitch: 3.81 mm, mounting: THR soldering, pin layout: Linear pinning, solder pin [P]: 1.4 mm, number of solder pins per potential: 1, plug-in system: COMBICON MC 1,5, Pin connector pattern alignment: Standard, locking: Screw locking, mounting: Threaded flange, type of packaging: packed in cardboard, For user information and design recommendations for through-hole reflow technology, go to: Downloads

MC 1,5/12-STF-3,81 - PCB connector

1827800

<https://www.phoenixcontact.com/us/products/1827800>



MCV 1,5/12-GF-3,81 P26 THR - PCB header

1707735

<https://www.phoenixcontact.com/us/products/1707735>

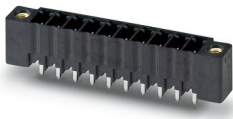

PCB headers, nominal cross section: 1.5 mm², color: black, nominal current: 8 A, rated voltage (III/2): 160 V, contact surface: Tin, type of contact: Male connector, number of potentials: 12, number of rows: 1, number of positions: 12, number of connections: 12, product range: MCV 1,5/..-GF-THR, pitch: 3.81 mm, mounting: THR soldering, pin layout: Linear pinning, solder pin [P]: 2.6 mm, number of solder pins per potential: 1, plug-in system: COMBICON MC 1,5, Pin connector pattern alignment: Standard, locking: Screw locking, mounting: Threaded flange, type of packaging: packed in cardboard, For user information and design recommendations for through-hole reflow technology, go to: Downloads

MCD 1,5/12-G1F-3,81 - PCB header

1843017

<https://www.phoenixcontact.com/us/products/1843017>



PCB headers, nominal cross section: 1.5 mm², color: green, nominal current: 8 A, rated voltage (III/2): 160 V, contact surface: Tin, type of contact: Male connector, number of potentials: 24, number of rows: 2, number of positions: 12, number of connections: 24, product range: MCD 1,5/..-G1F, pitch: 3.81 mm, mounting: Wave soldering, pin layout: Linear pinning, solder pin [P]: 3.5 mm, number of solder pins per potential: 1, plug-in system: COMBICON MC 1,5, Pin connector pattern alignment: Standard, locking: Screw locking, mounting: Threaded flange, type of packaging: packed in cardboard, In combination with MCV plug components, both an MCVW and an MCVR plug must be used.

Phoenix Contact 2023 © - all rights reserved
<https://www.phoenixcontact.com>

Phoenix Contact USA
586 Fulling Mill Road
Middletown, PA 17057, United States
(+717) 944-1300
info@phoenixcon.com