

GENERAL DESCRIPTION

The BL9352A is a wide input range, high-efficiency, and high frequency DC-to-DC step-down switching regulator, capable of delivering up to 0.6A of output current.

With a fixed switching frequency of 1.6MHz, this current mode PWM controlled converter allows the use of small external components, such as ceramic input and output caps, as well as small inductors.

Including cold crank and double battery jump-starts, the minimum input voltage may be as low as 4.5V and the maximum up to 45V, with even higher transient voltages. With these high input voltages, linear regulators cannot be used for high supply currents without overheating the regulator. Instead, high efficiency switching regulators such as BL9352A must be used to minimize thermal dissipation.

BL9352A is available SOT23-6 Packages.

FEATURES

- Wide Input Operating Range from 4.5V to 45V
- 420mΩ internal NMOS
- Up to 95% Efficiency at 16V in 12V out L=47uH with 300mA loading
- Internal compensation
- Capable of Delivering 600mA continuous output current
- Fixed 1.6MHz PWM operation
- Internal soft start
- Output voltage adjustable down to 0.795V
- Cycle-by-cycle current limit
- Current Mode control
- Short-circuit protection
- Logic Control Shutdown EN can be short to VIN
- Thermal shutdown and UVLO
- Available in SOT23-6 Package

APPLICATIONS

- Smart/Industrial/Power Meters
- Industrial Applications
- Automotive Applications

PIN OUT

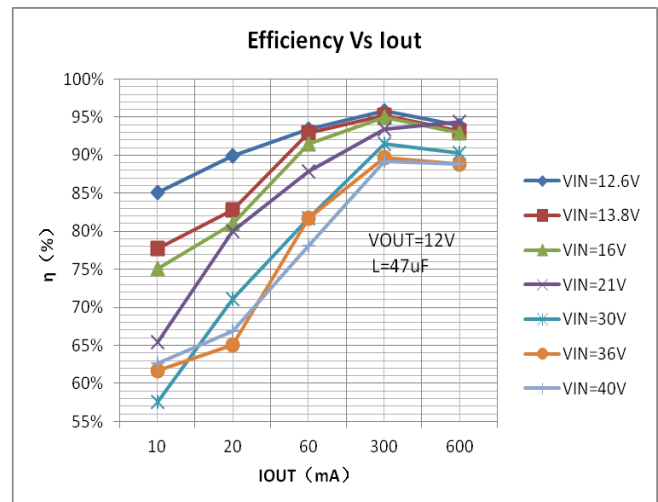
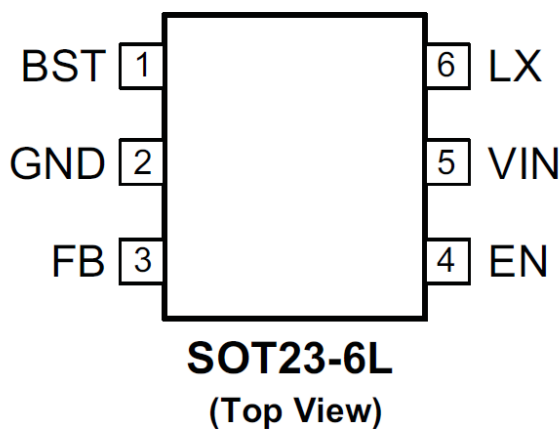

PINOUT DESCRIPTION

Pin #	Name	Description
1	BST	Bootstrap pin for top Switch. In Typ. application, a 0.1uF or larger capacitor should be connected between this pin and the LX pin to supply current to the top Switch gate and top Switch driver.
2	GND	Analog Ground
3	FB	Output feedback pin. In Typ. application, FB senses the output voltage and is regulated by the control loop to 800mV. Connect a resistive divider at FB.
4	EN	Drive EN pin high to turn on the regulator and low to turn off the regulator.
5	VIN	Input voltage pin, In Typ. application, VIN supplies power to the IC. Connect a 4.5V to 45V supply to VIN and bypass VIN to GND with a suitably large capacitor to eliminate noise on the input to the IC.
6	LX	LX is the Switching node that supplies power to the output Connect the output LC filter from LX to the output load.

TYPICAL APPLICATION

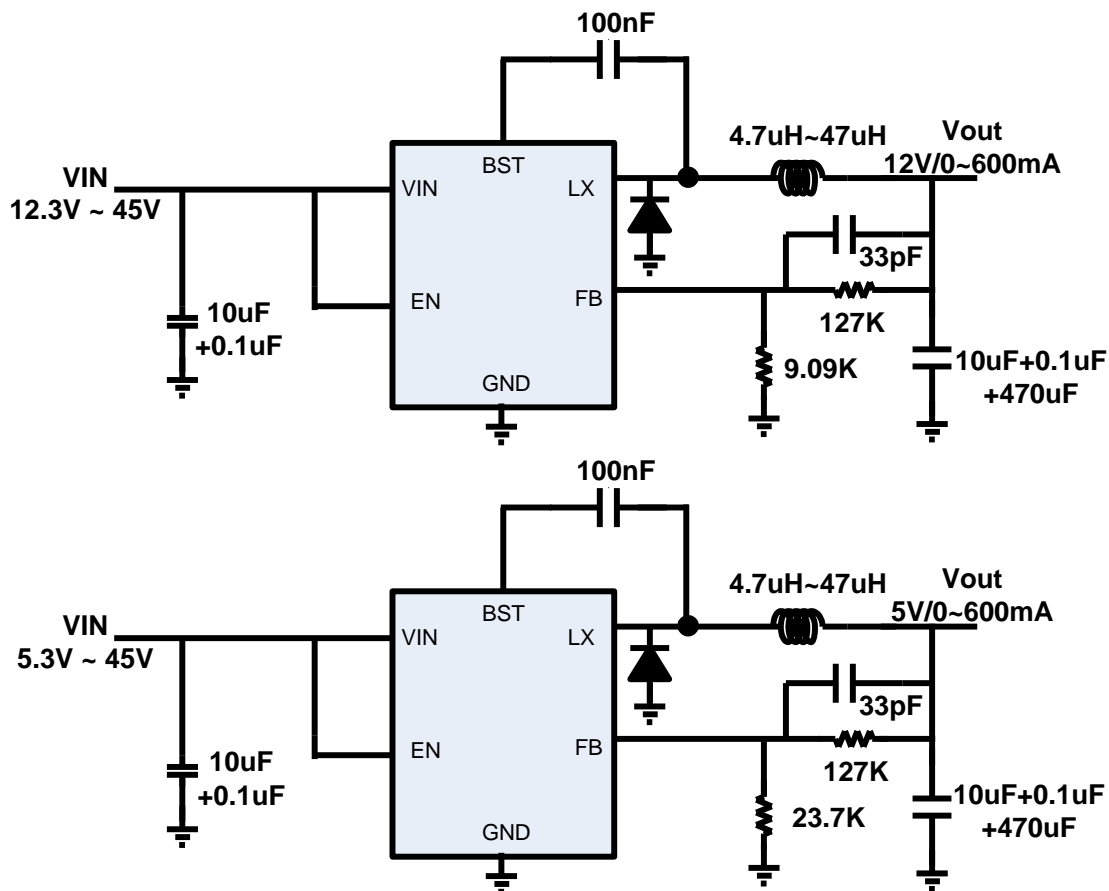

ELECTRICAL CHARACTERISTICS

(VIN = VEN = 16V, unless otherwise specified. Typical values are at TA = 25°C.)

SYMBOL	PARAMETER	Test conditions	MIN	TYP	MAX	UNITS
VIN	Input Voltage Range		4.5		45	V
Vin(UVLO)	Input UVLO		2.3		2.9	V
Vin(UVLO)hys	Input UVLO Hysteresis			0.26		V
IQ	Input Supply Current	Vfb=5V no loading		690		uA
Isd	Input Shutdown Current	Ven<0.3V			8	uA
VFB		3.3<Vin<40V	0.778	0.795	0.810	V
VFB_LOAD	Load regulation	120mA<load<600mA		0.5		%
VFB_line	Line regulation	Load =600mA		0.03		%/V
IFB	Feedback voltage input current	VFB=800mV		400		nA
ENABLE						
Ven_OFF	En high level	VFB=0V,rising	1.2			V
Ven_OFF	En low level	VFB=0V,falling			0.4	
En hys	En Hysteresis	VFB=0V		0.2		V
IEN	Enable input current				3	uA
MODULATOR						
Fosc	OSC frequency		1.28	1.6	1.92	MHz
Dmax				87		%
Ton min	Min on time			130		ns
Ilim	Limited current		0.75	0.95		A
Iswleak	LX Leakage Current	Ven=0V, Vlx=0V, Vin=40V			10	uA
Temp	Termal shutdown	Temp rising		150		℃
		Temp falling		110		℃
Tss	Soft start time	FB from 0 To 0.8V		1.8		msec
Power stage output						
Ileakage	NMOS leakage	VEN=0V, VLX=0V			10	uA
RDSON	NMOS on resistance	VIN=12V Vbst-Vlx=5V		420		mΩ

TYPICAL PERFORMANCE CHARACTERISTICS

(Typical values are at TA = 25°C unless otherwise specified.)

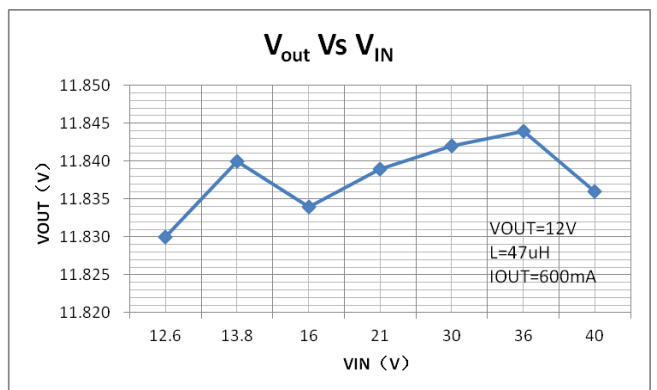
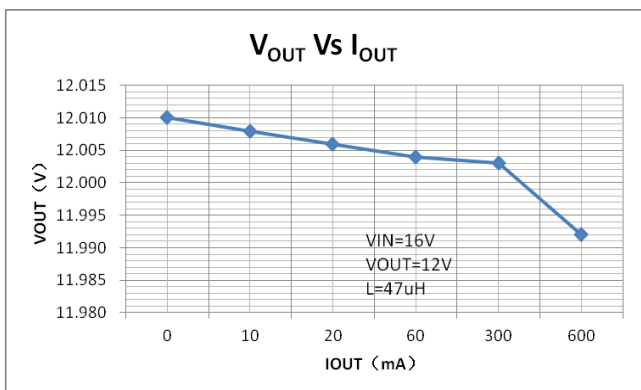
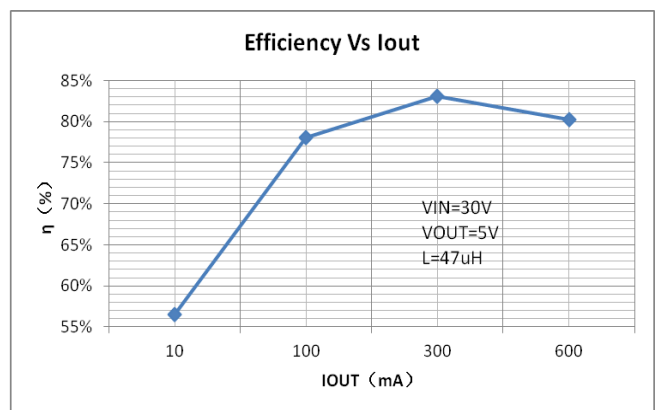
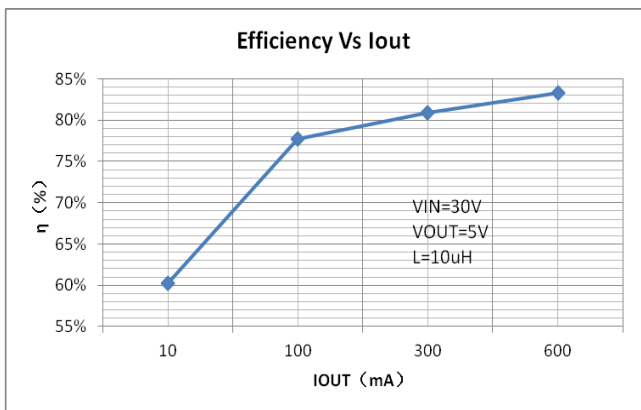
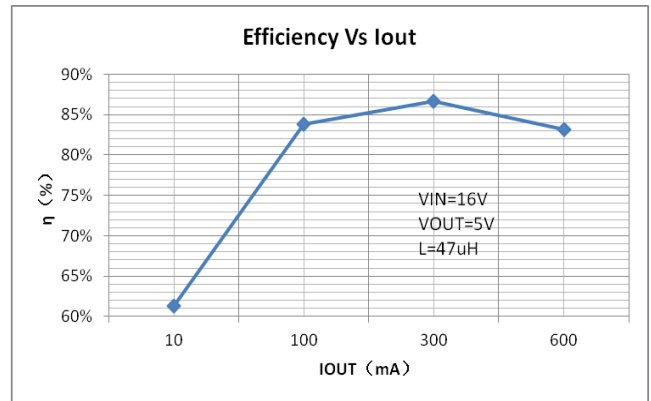
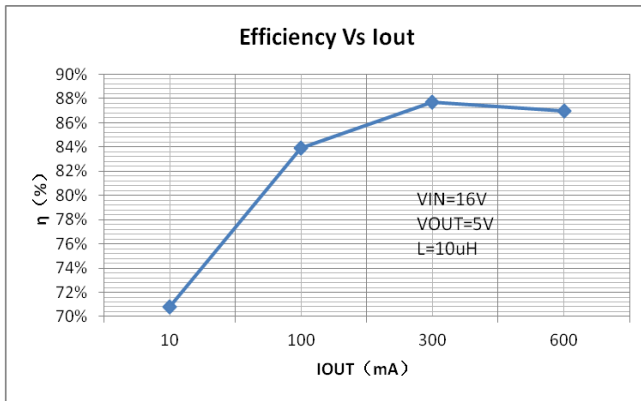

TYPICAL CHARACTERISTICS

(Typical values are at TA = 25°C unless otherwise specified.)

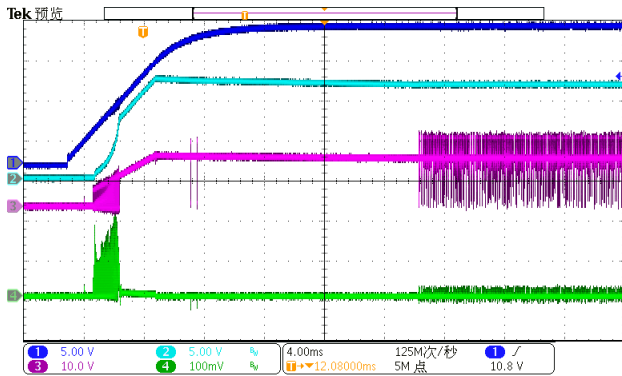

Start-up Waveform with EN=VIN
VIN=18V,VOUT=12V,IOU=0A,L=47uH
CH1 (VIN),CH2(VOUT),CH3(LX),CH4(IL)

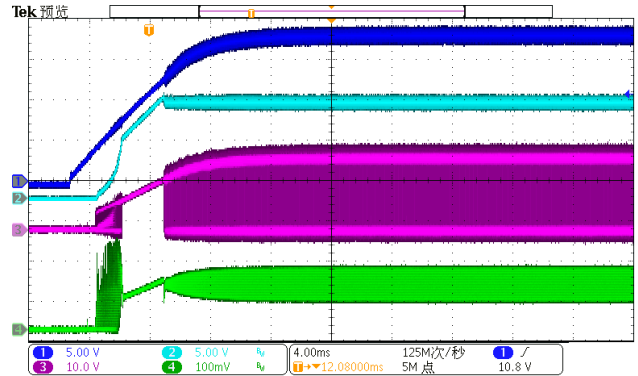

Start-up Waveform with EN=VIN
VIN=18V,VOUT=12V,IOU=125mA,L=47uH
CH1 (VIN),CH2(VOUT),CH3(LX),CH4(IL)

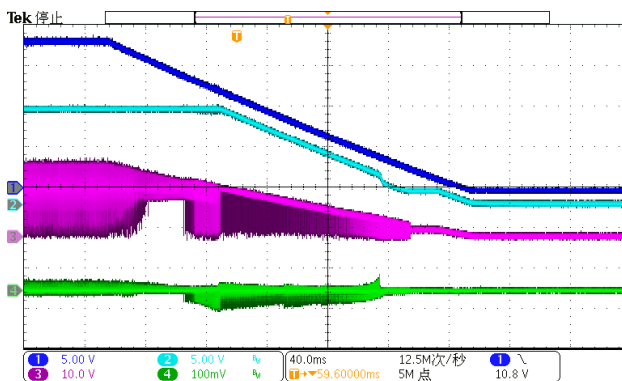

Shutdown Waveform with EN=VIN
VIN=18V,VOUT=12V,IOU=0A,L=47uH
CH1 (VIN),CH2(VOUT),CH3(LX),CH4(IL)

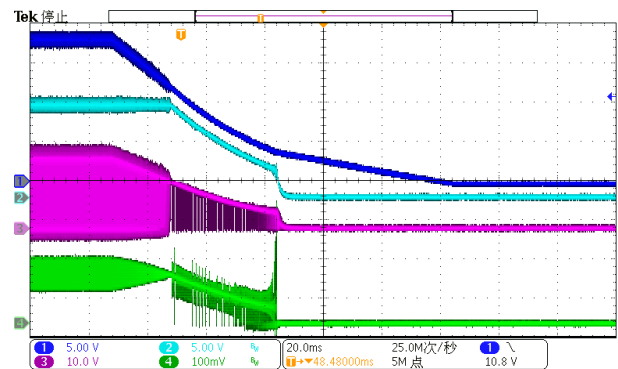

Shutdown Waveform with EN=VIN
VIN=18V,VOUT=12V,IOU=125mA,L=47uH
CH1 (VIN),CH2(VOUT),CH3(LX),CH4(IL)

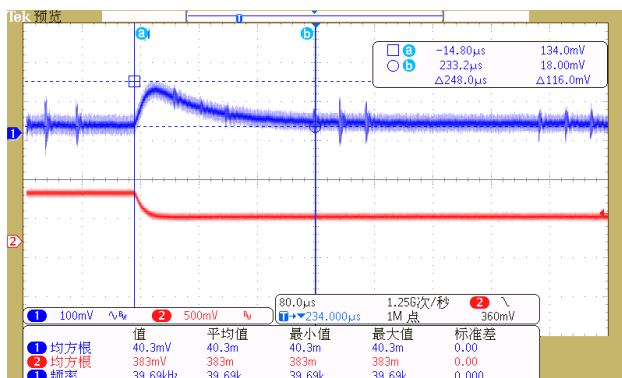

Trans response Waveform
VIN=16V,VOUT=12V, L=47uH
IOU=600mA to 300mA
CH1 (VOUT),CH2(Iload)

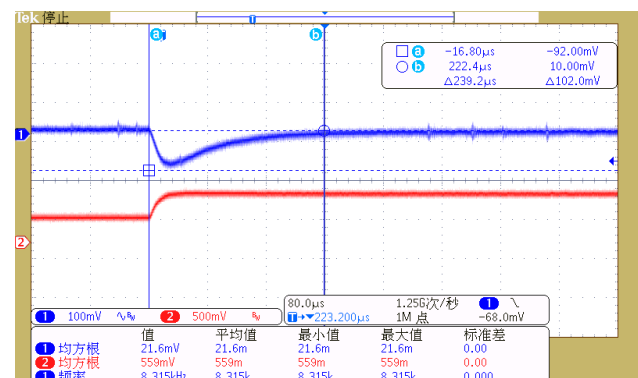

Trans response Waveform
VIN=16V,VOUT=12V, L=47uH
IOU=300mA to 600mA
CH1 (VOUT),CH2(Iload)

FUNCTIONAL DESCRIPTIONS

Loop Operation

The BL9352A is a wide input range, high-efficiency, DC-to-DC step-down switching regulator, capable of delivering up to 0.6A of output current, integrated with a 420mΩ high side MOSFET. It uses a PWM current-mode control scheme. An error amplifier integrates error between the FB signal and the internal reference voltage. The output of the integrator is then compared to the sum of a current-sense signal and the slope compensation ramp. This operation generates a PWM signal that modulates the duty cycle of the power MOSFETs to achieve regulation for output voltage.

APPLICATION INFORMATION

Setting Output Voltages

Output voltages are set by external resistors. The FB threshold is 0.8V.

$$R_{TOP} = R_{BOTTOM} \times [(V_{OUT} / 0.795) - 1]$$

Inductor Selection

The peak-to-peak ripple is limited to 30% of the maximum output current. This places the peak current far enough from the minimum over current trip level to ensure reliable operation while providing enough current ripples for the current mode converter to operate stably. In this case, for 0.6A maximum output current, the maximum inductor ripple current is 300 mA. The inductor size is estimated as following equation:

$$L_{IDEAL} = (V_{IN(MAX)} - V_{OUT}) / (I_{RIPPLE} \times D_{MIN} \times (1 / f_{OSC}))$$

Therefore, for $V_{OUT}=5V$, The inductor values is calculated to be $L = 13\mu H$. Chose $10\mu H$ or $15\mu H$

For $V_{OUT}=3.3V$, The inductor values is calculated to be $L = 9.2\mu H$. Chose $10\mu H$

Output Capacitor Selection

For most applications a nominal 22μF or larger capacitor is suitable. The BL9352A internal compensation is designed for a fixed corner frequency that is equal to $f_C = 8.7KHz$

For example, for $V_{OUT}=5V$, $L=15\mu H$, $C_{OUT}=22\mu F$.

The output capacitor keeps output ripple small and ensures control-loop stability. The output capacitor must also have low impedance at the switching frequency. Ceramic, polymer, and tantalum capacitors are suitable, with ceramic exhibiting the lowest ESR and high-frequency impedance. Output ripple with a ceramic output capacitor is approximately as follows: $V_{RIPPLE} = I_L(PEAK) [1 / (2\pi \times f_{OSC} \times C_{OUT})]$

If the capacitor has significant ESR, the output ripple component due to capacitor ESR is as follows:

$$V_{RIPPLE(ESR)} = I_L(PEAK) \times ESR$$

Input Capacitor Selection

The input capacitor in a DC-to-DC converter reduces current peaks drawn from the battery or other input power source and reduces switching noise in the controller. The impedance of the input capacitor at the switching frequency should be less than that of the input source so high-frequency switching currents do not pass through the input source. The output capacitor keeps output ripple small and ensures control-loop stability.

Components Selection

VOUT (V)	COUT (μF)	L (μH)
12	22	15 to 22
5	22	10 to 15
3.3	22	6.8 to 10

PACKAGE OUTLINE

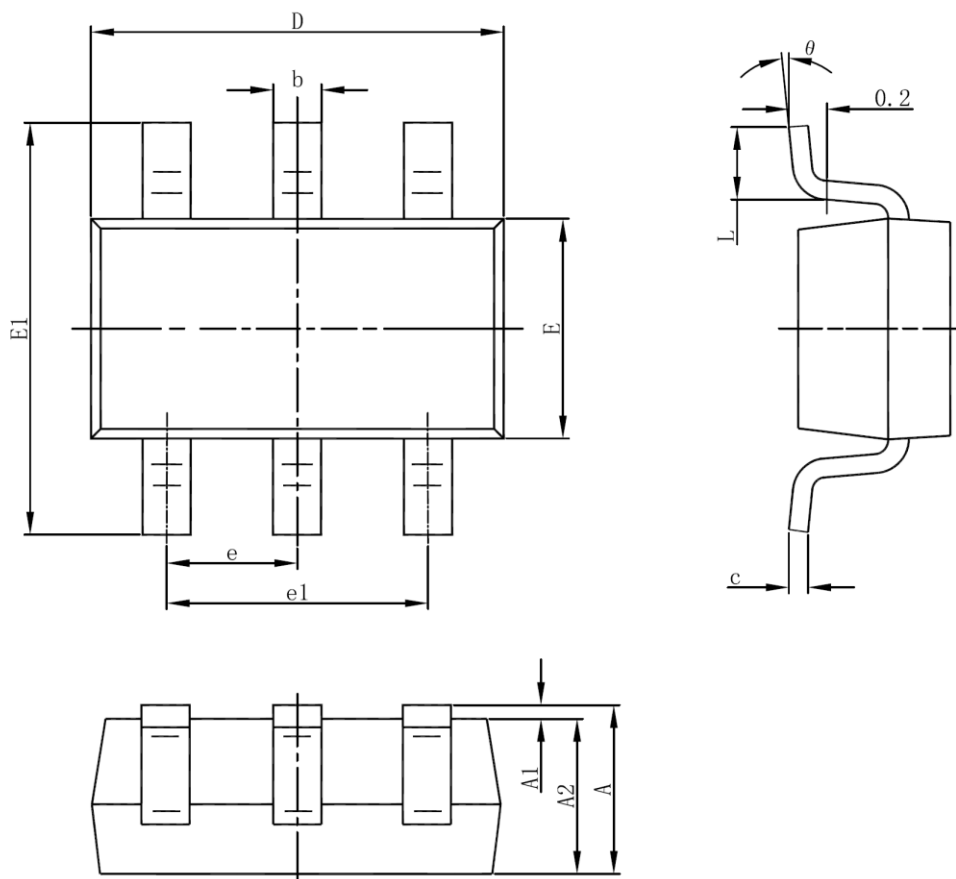

Symbol	Dimensions In Millimeters		Dimensions In Inches	
	Min	Max	Min	Max
A	1.050	1.250	0.041	0.049
A1	0.000	0.100	0.000	0.004
A2	1.050	1.150	0.041	0.045
b	0.300	0.500	0.012	0.020
c	0.100	0.200	0.004	0.008
D	2.820	3.020	0.111	0.119
E	1.500	1.700	0.059	0.067
E1	2.650	2.950	0.104	0.116
e	0.950(BSC)		0.037(BSC)	
e1	1.800	2.000	0.071	0.079
L	0.300	0.600	0.012	0.024
θ	0°	8°	0°	8°