

RoHS

Specification

规格书

Customer Name:

客户名称: _____

Customer P/N:

客户品号: _____

Factory P/N:

公司品号: GL-5250R01C2-2.5

Sending Date:

送样日期: _____

Client approval 客户审核			Goozo approval 鸿利国泽审核		
Approval 核准	Audit 确认	Confirmation 制作	Approval 核准	Audit 确认	Confirmation 制作
<input type="checkbox"/> Qualified 接受		<input type="checkbox"/> Disqualified 不接受		DATE: 日期:	

Address: Dangui Road NO. 1 Dantu Area Zhenjiang City Jiangsu Province

地址: 江苏省镇江市丹徒区丹桂路 1 号

Tel/电话: 0511-88786599

Fax/传真: 0511-88786599

Web/网址: www.goozo.com.cn

注:

1. 此规格书以中英文方式书写,若有冲突以中文版本为准文本.

2. 此规格书的最终解释权归属江苏鸿利国泽光电科技有限公司

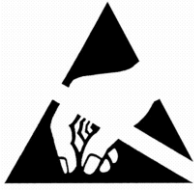

ATTENTION 注意
 OBSERVE PRECAUTIONS
 FOR HANDLING
 ELECTROSTATIC
 DISCHARGE
 SENSITIVE
 DEVICES

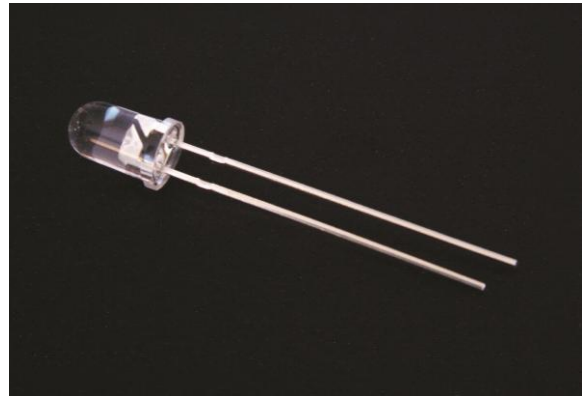

Features

φ5 LAMP LED/5mm 外形
 Low Power Consumption/低功耗
 Cabined Viewing Angle/小角度
 Ideal For Traffic\Backlight Lighting And Indicator
 /交通信号、背光、指示用

Description/描述

This devices are made with AlGaInP/LED
 芯片组成元素 AlGaInP.

Package Dimensions

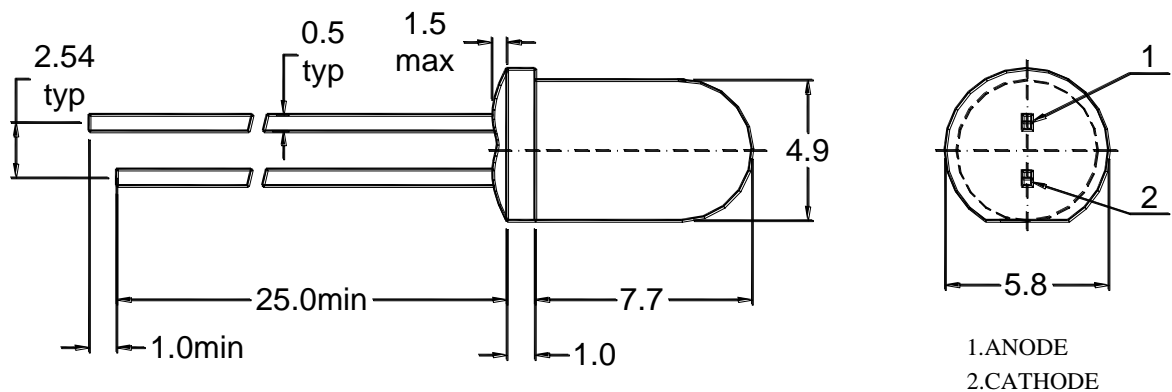

Tolerance Grade/公差等级	Dimension Tolerance/尺寸 (Unit:mm)			
	0.5~3	3~6	6~30	30~120
	±0.1	±0.2	±0.3	±0.5
Chip/晶片		Lens Color/胶体颜色		
Material/材质	Emitting Color/ 发光颜色	Water Clear/无色透明		
AlGaInP	Red/红色			

■ Absolute Maximum Rating

Item 项目	Symbol 符号	Value 数值	Unit 单位
Forward Current 正向电流	IF	30	mA
Peak Forward Current* 峰值正向电流	IFP	100	mA
Reverse Voltage 反向电压	VR	5	V
Power Dissipation 功耗	PD	110	mW
Electrostatic discharge 抗静电能力	ESD	2000	V
Operation Temperature 操作温度	Topr	-30~+80	°C
Storage Temperature 储存温度	Tstg	-40~+100	°C
Lead Soldering Temperature* 引脚焊接温度	Tsol	Max. 260°C for 5sec Max.	

*IFP Conditions: Pulse Width≤10msec /IFP 正向峰值电流使用条件: 脉冲宽度≤10 毫秒

*Tsol Conditions: 1.6mm from the base of the epoxy bulb/Tsol 焊接条件: 焊接位置离胶体底部 1.6 毫米

■ Typical Optical/ Electrical Characteristics Ta=25°C

Item/项目	Symbol/符号	Condition/条件	Rank/档次	Min. 最小值	Typ. 典型值	Max. 最大值	Unit 单位
Luminous Intensity/光强	Iv	IF=20mA		--	5000	--	mcd
Forward Voltage/正向电压	VF			1.8	2.2	2.6	V
Viewing Angle/角度	2θ 1/2			--	30	--	deg
Dominant Wavelength/主波长	λD			618	--	627	nm
Recommend Forward Current/推荐使用正向电流	IF(rec)	--		--	--	20	mA
Reverse Current/反向电流	IR	Vr=5V		--	--	10	uA

Notes/注释:

Tolerance : VF±0.1V, λd±2 nm, IV(φV) ±15%, 2θ 1/2±15%, X/Y±0.005.

公差: 正向电压±0.1V, 主波长±2 nm, 光强 (光通量) ±15%, 角度±15%, X/Y±0.005.

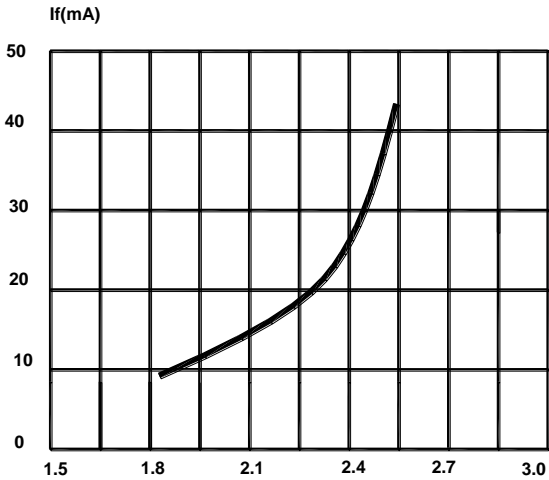

Forward Current vs. Forward Voltage

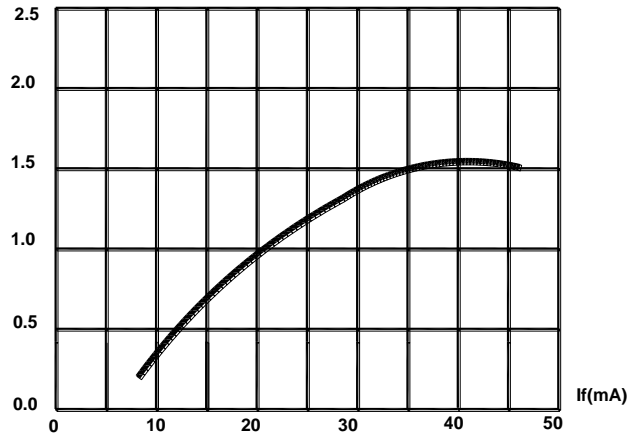

Relative Luminous Intensity vs. Forward Current

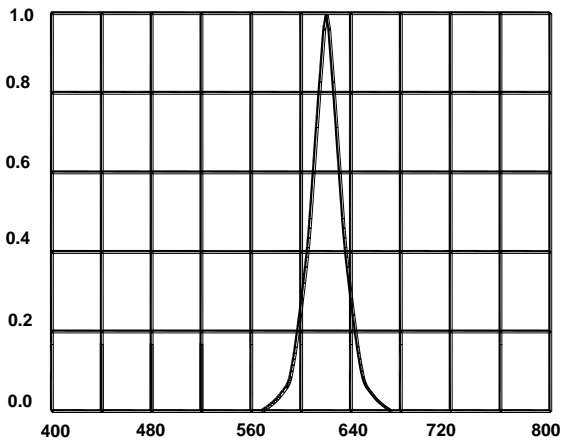

Relative Luminous Intensity vs. Wavelength

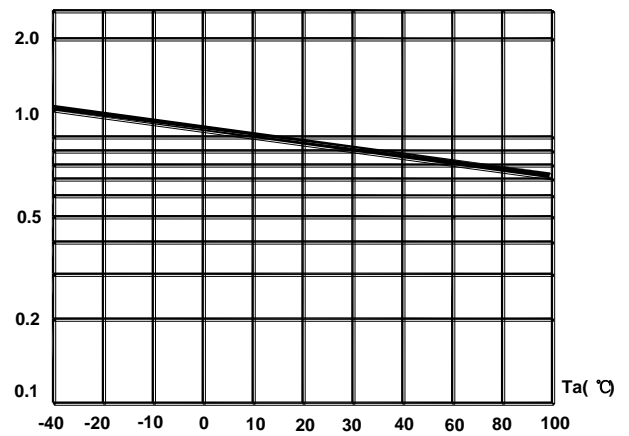

Relative Luminous Intensity vs. Ambient Temperature

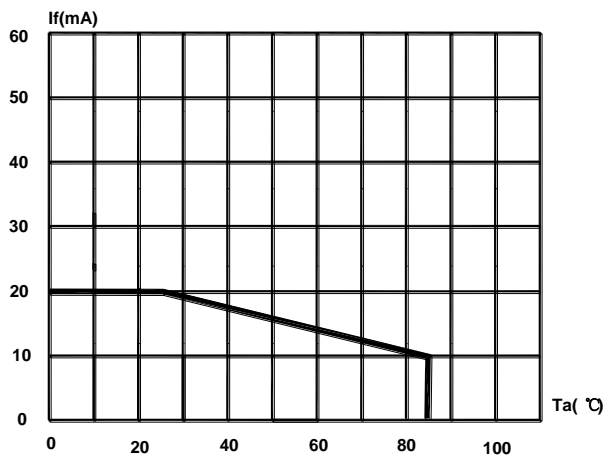

Maximum Forward Current vs. Ambient Temperature

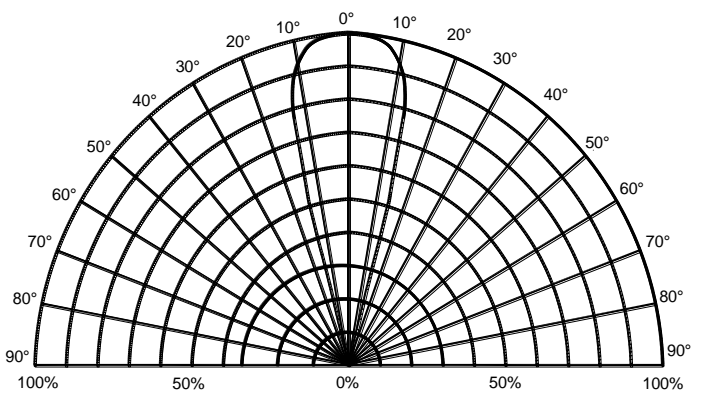

Relative Luminous Intensity vs. Radiation Angle

■ Reliability Performance 可靠性
Test Items And Result 测试项目和判定

Test Classification 测试类别	Test Item 测试项目	Test Conditions 测试条件	Test Duration 测试持续时间	Sample Size 样品数量	AC/RE 接受/拒收
Life Test 寿命测试	Room Temperature DC Operating Life Test 室温直流寿命测试	$T_a=25^{\circ}\text{C}\pm 5^{\circ}\text{C}$, $I_f=20\text{mA}$	1000 hrs	22 pcs	0/1
Environment Test 环境模拟 实验	Thermal Shock Test 冷热冲击	$100^{\circ}\text{C}\pm 5^{\circ}\text{C}$ 5min ↑↓ $-40^{\circ}\text{C}\pm 5^{\circ}\text{C}$ 5min.	100 cycles	22 pcs	0/1
	Temperature Cycle Test 高低温循环实验	$100^{\circ}\text{C}\pm 5^{\circ}\text{C}$ 30min ↑↓5min $-40^{\circ}\text{C}\pm 5^{\circ}\text{C}$ 30min.	100 cycles	22 pcs	0/1
	High Temperature & High Humidity Test 高温高湿实验	$85^{\circ}\text{C}\pm 5^{\circ}\text{C}/85\% \text{RH}$ $I_F=5\text{mA}$	1000 hrs	22 pcs	0/1
	High Temperature Storage 高温储存	$T_a=100^{\circ}\text{C}\pm 5^{\circ}\text{C}$	1000 hrs	22 pcs	0/1
	Low Temperature Storage 低温储存	$T_a=-40^{\circ}\text{C}\pm 5^{\circ}\text{C}$	1000 hrs	22 pcs	0/1
Mechanica Test 机械测试	Resistance to Soldering Heat 耐焊接实验	Temp= 260°C max T=5sec max	1 times	22 pcs	0/1
	Lead Integrity 引脚折弯实验	Load 2.5N(0.25kgf) $0^{\circ} \sim 90^{\circ} \sim 0^{\circ}$	3 times	22 pcs	0/1

■ Dip Soldering/焊接

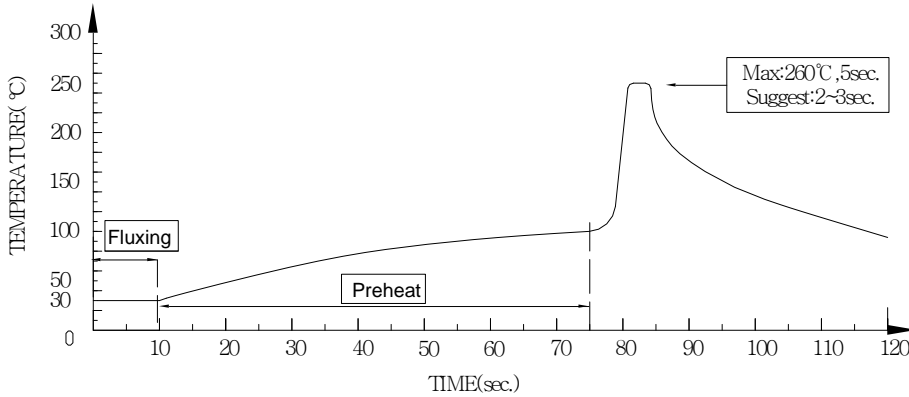

1. Please avoid any external stress applied to the lead-frames and epoxy while the LEDs are at high temperature, especially during soldering/在高温焊接过程中，不可有任何外力施加在 LED 的引脚、环氧上；
2. DIP soldering and hand soldering should not be done more than one time/浸焊、手工焊接次数不可超过 1 次；
3. After soldering, avoid the epoxy lens from mechanical shock or vibration until the LEDs are back to room temperature/焊接后，在 LED 温度恢复到室温的过程中，不可受到震动或其它外力的冲击；
4. Avoid rapid cooling during temperature ramp-down process/在 LED 降温过程中，避免急剧的冷却；
5. Although the soldering condition is recommended above, soldering at the lowest possible temperature is feasible for the LEDs/LED 在焊接过程中，应尽可能的降低焊接温度，以减少高温对 LED 的损伤；

■ IRON Soldering/手动焊接

300°C Within 3 sec., One time only/300°C，3 秒，1 次；