

# TPS53915 1.5 to 18-V (4.5 to 25-V Bias) Input, 12-A Synchronous Step-Down SWIFT™ Converter With PMBus™

## 1 Features

- Integrated 13.8– and 5.9-mΩ MOSFETs Support 12-A Continuous Output Current
- Adjustments Available Through PMBus™
  - Voltage Margin and Adjustment
  - Soft-Start Time
  - Power-On Delay
  - VDD UVLO Level
  - Fault Reporting
  - Switching Frequency
- Supports All Ceramic Output Capacitors
- Reference Voltage 600 mV ±0.5% Tolerance
- Output Voltage Range: 0.6 V to 5.5 V
- D-CAP3™ Control Mode With Fast Load-Step Response
- Auto-Skipping Eco-Mode™ for High Light-Load Efficiency
- FCCM for Tight Output Ripple and Voltage Requirements
- Eight Selectable Frequency Settings from 200 kHz to 1 MHz
- 3.5 mm × 4.5 mm, 28-Pin, QFN Package

## 2 Applications

- Server and Cloud-Computing Point-of-Load (POL) Products
- Broadband, Networking, and Optical Communications Infrastructure
- I/O Supplies
- Supported at the [WEBENCH™ Design Center](#)

## 3 Description

The TPS53915 is a small-sized, synchronous buck converter with an adaptive on-time D-CAP3 control mode. The device offers ease-of-use and low external-component count for space-conscious power systems.

This device features high-performance integrated MOSFETs, accurate 0.5% 0.6-V reference, and an integrated boost switch. Competitive features include very-low external-component count, fast load-transient response, auto-skip mode operation, internal soft-start control, and no requirement for compensation. The device also features programmability and fault report via PMBus™ to simplify the power supply design.

A forced continuous conduction mode helps meet tight voltage regulation accuracy requirements for performance DSPs and FPGAs. The TPS53915 is available in a 28-pin QFN package and is specified from –40°C to 85°C ambient temperature.

### Device Information<sup>(1)</sup>

| PART NUMBER | PACKAGE        | BODY SIZE (NOM)   |
|-------------|----------------|-------------------|
| TPS53915    | VQFN-CLIP (28) | 4.50 mm x 3.50 mm |

(1) For all available packages, see the orderable addendum at the end of the datasheet.

### Simplified Schematic

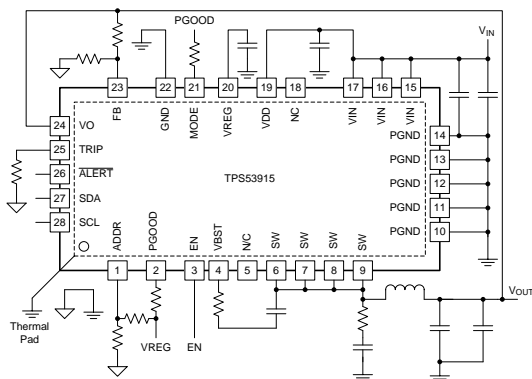

### Efficiency vs Output Current

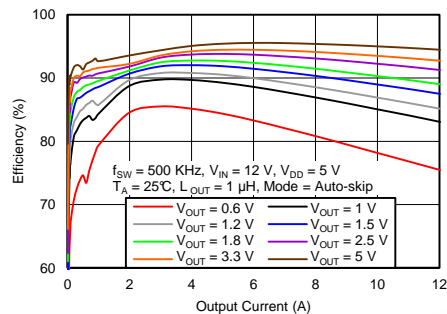

## Table of Contents

|  |           |  |           |
|--|-----------|--|-----------|
| <b>1 Features</b> .....                        | <b>1</b>  | 7.3 Feature Description.....                                     | <b>17</b> |
| <b>2 Applications</b> .....                    | <b>1</b>  | 7.4 Device Functional Modes.....                                 | <b>23</b> |
| <b>3 Description</b> .....                     | <b>1</b>  | 7.5 Programming.....   | <b>24</b> |
| <b>4 Revision History</b> .....                | <b>2</b>  | <b>8 Application and Implementation</b> .....                    | <b>35</b> |
| <b>5 Pin Configuration and Functions</b> ..... | <b>3</b>  | 8.1 Application Information.....                                 | <b>35</b> |
| <b>6 Specifications</b> .....                  | <b>4</b>  | 8.2 Typical Application .....                                    | <b>35</b> |
| 6.1 Absolute Maximum Ratings .....             | <b>4</b>  | <b>9 Power Supply Recommendations</b> .....                      | <b>40</b> |
| 6.2 ESD Ratings.....                           | <b>4</b>  | <b>10 Layout</b> .....   | <b>40</b> |
| 6.3 Recommended Operating Conditions .....     | <b>5</b>  | 10.1 Layout Guidelines .....                                     | <b>40</b> |
| 6.4 Thermal Information .....                  | <b>5</b>  | 10.2 Layout Example .....  | <b>41</b> |
| 6.5 Electrical Characteristics.....            | <b>5</b>  | <b>11 Device and Documentation Support</b> .....                 | <b>42</b> |
| 6.6 Typical Characteristics.....               | <b>9</b>  | 11.1 Documentation Support .....                                 | <b>42</b> |
| 6.7 Thermal Performance .....                  | <b>15</b> | 11.2 Trademarks .....  | <b>42</b> |
| <b>7 Detailed Description</b> .....            | <b>16</b> | 11.3 Electrostatic Discharge Caution.....                        | <b>42</b> |
| 7.1 Overview .....                             | <b>16</b> | 11.4 Glossary .....  | <b>42</b> |
| 7.2 Functional Block Diagrams .....            | <b>17</b> | <b>12 Mechanical, Packaging, and Orderable Information</b> ..... | <b>42</b> |

## 4 Revision History

NOTE: Page numbers for previous revisions may differ from page numbers in the current version.

| <b>Changes from Revision A (December 2013) to Revision B</b>  | <b>Page</b> |
|---|-------------|
| <ul style="list-style-type: none"> <li>Added <i>Pin Configuration and Functions</i> section, <i>Handling Rating</i> table, <i>Feature Description</i> section, <i>Device Functional Modes</i>, <i>Application and Implementation</i> section, <i>Power Supply Recommendations</i> section, <i>Layout</i> section, <i>Device and Documentation Support</i> section, and <i>Mechanical, Packaging, and Orderable Information</i> section .....</li> </ul> | <b>1</b>    |

| <b>Changes from Original (November 2013) to Revision A</b>  | <b>Page</b> |
|---|-------------|
| <ul style="list-style-type: none"> <li>Changed device dimensions from 3,5 mm × 4,5 mm to 3.5 mm × 4.5 mm .....</li> </ul> | <b>1</b>    |



## 5 Pin Configuration and Functions

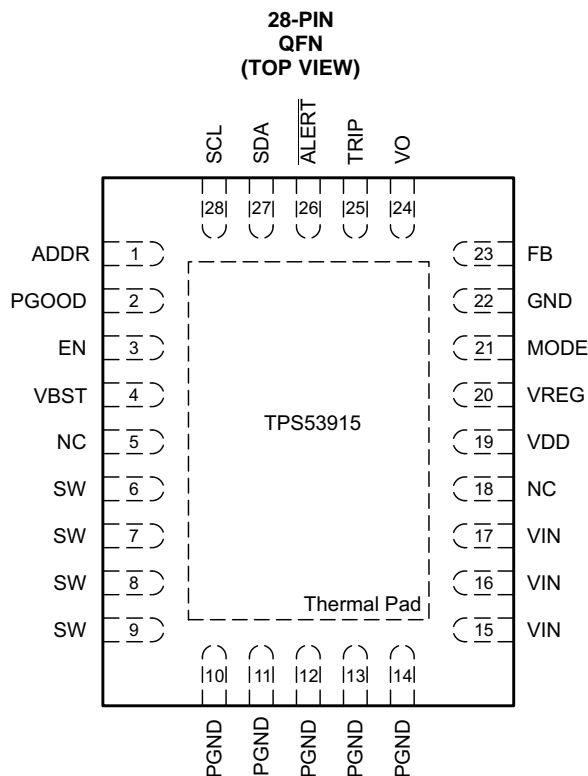

**Pin Functions<sup>(1)</sup>**

| PIN   |                            | I/O | DESCRIPTION  |
|-------|----------------------------|-----|--|
| NAME  | NO.                        |     |  |
| ADDR  | 1                          | I   | PMBus address configuration pin. Connect this pin into a resistor divider between VREG and GND to program different address settings   |
| ALERT | 26                         | O   | Alert output for the PMBus interface   |
| EN    | 3                          | I   | The enable pin turns on the DC-DC switching converter.   |
| FB    | 23                         | I   | V <sub>OUT</sub> feedback input. Connect this pin to a resistor divider between the VOUT pin and GND.  |
| GND   | 22                         | G   | This pin is the ground of internal analog circuitry and driver circuitry. Connect GND to the PGND plane with a short trace (For example, connect this pin to the thermal pad with a single trace and connect the thermal pad to PGND pins and PGND plane). |
| MODE  | 21                         | I   | The MODE pin sets the forced continuous-conduction mode (FCCM) or Skip-mode operation. It also selects the ramp coefficient of D-CAP3 mode.  |
| NC    | 5<br>18                    | —   | Not connected. These pins are floating internally.   |
| PGND  | 10<br>11<br>12<br>13<br>14 | G   | These ground pins are connected to the return of the internal low-side MOSFET.   |
| PGOOD | 2                          | O   | Open-drain power-good status signal which provides startup delay after the FB voltage falls within the specified limits. After the FB voltage moves outside the specified limits, PGOOD goes low within 2 $\mu$ s.   |
| SCL   | 28                         | I   | Clock input for the PMBus interface  |
| SDA   | 27                         | I/O | Data I/O for the PMBus interface   |

(1) I = Input, O = Output, P = Supply, G = Ground

**Pin Functions<sup>(1)</sup> (continued)**

| PIN  |     | I/O | DESCRIPTION  |
|------|-----|-----|--|
| NAME | NO. |     |  |
| SW   | 6   | I/O | SW is the output switching terminal of the power converter. Connect this pin to the output inductor.   |
|      | 7   |     |  |
|      | 8   |     |  |
|      | 9   |     |  |
| TRIP | 25  | I/O | TRIP is the OCL detection threshold setting pin. $I_{TRIP} = 10 \mu A$ at $T_A = 25^\circ C$ , 3000 ppm/ $^\circ C$ current is sourced and sets the OCL trip voltage. See the <a href="#">Current Sense and Overcurrent Protection</a> section for detailed OCP setting. |
| VBST | 4   | P   | VBST is the supply rail for the high-side gate driver (boost terminal). Connect the bootstrap capacitor from this pin to the SW node. Internally connected to VREG via bootstrap PMOS switch.  |
| VDD  | 19  | P   | Power-supply input pin for controller. Input of the VREG LDO. The input range is from 4.5 to 25 V.   |
| VIN  | 15  | P   | VIN is the conversion power-supply input pins.   |
|      | 16  |     |  |
|      | 17  |     |  |
| VREG | 20  | O   | VREG is the 5-V LDO output. This voltage supplies the internal circuitry and gate driver.  |
| VO   | 24  | I   | VO is the VOUT voltage input to the controller.  |

**6 Specifications**

**6.1 Absolute Maximum Ratings**

over operating free-air temperature range (unless otherwise noted)<sup>(1)</sup>

|                                    |                             | MIN               | MAX | UNIT       |    |
|------------------------------------|-----------------------------|-------------------|-----|------------|----|
| Input voltage range <sup>(2)</sup> | EN                          | -0.3              | 7.7 | V          |    |
|                                    | SW                          | DC                | -3  |            | 30 |
|                                    |                             | Transient < 10 ns | -5  |            | 32 |
|                                    | VBST                        | -0.3              | 36  |            |    |
|                                    | VBST <sup>(3)</sup>         | -0.3              | 6   |            |    |
|                                    | VBST when transient < 10 ns |                   | 38  |            |    |
|                                    | VDD                         | -0.3              | 28  |            |    |
|                                    | VIN                         | -0.3              | 30  |            |    |
| ADDR, FB, MODE, SDA, SCL, VO       | -0.3                        | 6                 |     |            |    |
| Output voltage range               | PGOOD                       | -0.3              | 7.7 | V          |    |
|                                    | ALERT, TRIP, VREG           | -0.3              | 6   |            |    |
| Junction Temperature, $T_J$        |                             | -40               | 150 | $^\circ C$ |    |
| Storage Temperature, $T_{stg}$     |                             | -55               | 150 | $^\circ C$ |    |

(1) Stresses beyond those listed under [Absolute Maximum Ratings](#) may cause permanent damage to the device. These are stress ratings only, and functional operation of the device at these or any other conditions beyond those indicated under [Recommended Operating Conditions](#) is not implied. Exposure to absolute-maximum-rated conditions for extended periods may affect device reliability.

(2) All voltages are with respect to network ground terminal.

(3) Voltage values are with respect to the SW terminal.

**6.2 ESD Ratings**

|                                     |  | VALUE      | UNIT |
|-------------------------------------|--|------------|------|
| $V_{(ESD)}$ Electrostatic discharge | Human-body model (HBM), per ANSI/ESDA/JEDEC JS-001 <sup>(1)</sup>              | $\pm 2500$ | V    |
|                                     | Charged-device model (CDM), per JEDEC specification JESD22-C101 <sup>(2)</sup> | $\pm 1500$ |      |

(1) JEDEC document JEP155 states that 500-V HBM allows safe manufacturing with a standard ESD control process.

(2) JEDEC document JEP157 states that 250-V CDM allows safe manufacturing with a standard ESD control process.

### 6.3 Recommended Operating Conditions

over operating free-air temperature range (unless otherwise noted)

|                      |                                | MIN  | MAX | UNIT |
|----------------------|--------------------------------|------|-----|------|
| Input voltage range  | EN                             | -0.1 | 7   | V    |
|                      | SW                             | -3   | 27  |      |
|                      | VBST                           | -0.1 | 28  |      |
|                      | VBST <sup>(1)</sup>            | -0.1 | 5.5 |      |
|                      | VDD                            | 4.5  | 25  |      |
|                      | VIN                            | 1.5  | 18  |      |
|                      | ADDR, FB, MODE, SDA, SCL, VO   | -0.1 | 5.5 |      |
| Output voltage range | PGOOD                          | -0.1 | 7   | V    |
|                      | ALERT, TRIP, VREG              | -0.1 | 5.5 |      |
| T <sub>A</sub>       | Operating free-air temperature | -40  | 85  | °C   |

(1) Voltage values are with respect to the SW pin.

### 6.4 Thermal Information

| THERMAL METRIC <sup>(1)</sup> |   | TPS53915 | UNIT |
|-------------------------------|---|----------|------|
|                               |   | RVE      |      |
|                               |   | 28 PINS  |      |
| $\theta_{JA}$                 | Junction-to-ambient thermal resistance <sup>(2)</sup>       | 37.5     | °C/W |
| $\theta_{JCTop}$              | Junction-to-case (top) thermal resistance <sup>(3)</sup>    | 34.1     |      |
| $\theta_{JB}$                 | Junction-to-board thermal resistance <sup>(4)</sup>         | 18.1     |      |
| $\psi_{JT}$                   | Junction-to-top characterization parameter <sup>(5)</sup>   | 1.8      |      |
| $\psi_{JB}$                   | Junction-to-board characterization parameter <sup>(6)</sup> | 18.1     |      |
| $\theta_{JCbott}$             | Junction-to-case (bottom) thermal resistance <sup>(7)</sup> | 2.2      |      |

- (1) For more information about traditional and new thermal metrics, see the *IC Package Thermal Metrics* application report, [SPRA953](#).
- (2) The junction-to-ambient thermal resistance under natural convection is obtained in a simulation on a JEDEC-standard, high-K board, as specified in JESD51-7, in an environment described in JESD51-2a.
- (3) The junction-to-case (top) thermal resistance is obtained by simulating a cold plate test on the package top. No specific JEDEC-standard test exists, but a close description can be found in the ANSI SEMI standard G30-88.
- (4) The junction-to-board thermal resistance is obtained by simulating in an environment with a ring cold plate fixture to control the PCB temperature, as described in JESD51-8.
- (5) The junction-to-top characterization parameter,  $\psi_{JT}$ , estimates the junction temperature of a device in a real system and is extracted from the simulation data for obtaining  $R_{\theta JA}$ , using a procedure described in JESD51-2a (sections 6 and 7).
- (6) The junction-to-board characterization parameter,  $\psi_{JB}$ , estimates the junction temperature of a device in a real system and is extracted from the simulation data for obtaining  $R_{\theta JA}$ , using a procedure described in JESD51-2a (sections 6 and 7).
- (7) The junction-to-case (bottom) thermal resistance is obtained by simulating a cold plate test on the exposed (power) pad. No specific JEDEC standard test exists, but a close description can be found in the ANSI SEMI standard G30-88.

### 6.5 Electrical Characteristics

over operating free-air temperature range,  $V_{REG} = 5\text{ V}$ ,  $V_{EN} = 5\text{ V}$  (unless otherwise noted)

| PARAMETER             |                             | TEST CONDITIONS   | MIN   | TYP  | MAX  | UNIT |
|-----------------------|-----------------------------|---|-------|------|------|------|
| <b>SUPPLY CURRENT</b> |                             |   |       |      |      |      |
| $I_{VDD}$             | VDD bias current            | T <sub>A</sub> = 25°C, No load<br>Power conversion enabled (no switching) |       | 1350 | 1850 | μA   |
| $I_{VDDSTBY}$         | VDD standby current         | T <sub>A</sub> = 25°C, No load<br>Power conversion disabled               |       | 850  | 1150 | μA   |
| $I_{VIN(leak)}$       | VIN leakage current         | V <sub>EN</sub> = 0 V   |       |      | 0.5  | μA   |
| <b>VREF OUTPUT</b>    |                             |   |       |      |      |      |
| V <sub>VREF</sub>     | Reference voltage           | FB w/r/t GND, T <sub>A</sub> = 25°C                                       | 597   | 600  | 603  | mV   |
| V <sub>VREFTOL</sub>  | Reference voltage tolerance | FB w/r/t GND, T <sub>J</sub> = 0°C to 85°C                                | -0.6% |      | 0.5% |      |
|                       |                             | FB w/r/t GND, T <sub>J</sub> = -40°C to 85°C                              | -0.7% |      | 0.5% |      |

**Electrical Characteristics (continued)**

 over operating free-air temperature range,  $V_{REG} = 5\text{ V}$ ,  $V_{EN} = 5\text{ V}$  (unless otherwise noted)

| PARAMETER                     |                              | TEST CONDITIONS  | MIN  | TYP  | MAX  | UNIT          |
|-------------------------------|------------------------------|--|------|------|------|---------------|
| <b>OUTPUT VOLTAGE</b>         |                              |  |      |      |      |               |
| $I_{FB}$                      | FB input current             | $V_{FB} = 600\text{ mV}$   |      | 50   | 100  | nA            |
| $I_{VODIS}$                   | VO discharge current         | $V_{VO} = 0.5\text{ V}$ , Power Conversion Disabled  | 10   | 12   | 15   | mA            |
| <b>INTERNAL DAC REFERENCE</b> |                              |  |      |      |      |               |
| $V_{DACTOL1}$                 | DAC voltage tolerance 1      | FB w/r/t GND, $0^\circ\text{C} \leq T_A \leq 85^\circ\text{C}$ , with certain VOUT_ADJUSTMENT settings only <sup>(1)</sup> | -4.8 |      | 4.8  | mV            |
| $V_{DACTOL2}$                 | DAC voltage tolerance 2      | FB w/r/t GND, $0^\circ\text{C} \leq T_A \leq 85^\circ\text{C}$ , with certain VOUT_MARGIN settings only <sup>(2)</sup>     | -4.8 |      | 4.8  | mV            |
| $V_{DACTOL3}$                 | DAC voltage tolerance 3      | FB w/r/t GND, $0^\circ\text{C} \leq T_A \leq 85^\circ\text{C}$ , with VOUT_ADJUSTMENT=0Dh and VOUT_MARGIN=70h for 5%       | -4.8 |      | 4.8  | mV            |
| $V_{DACTOL4}$                 | DAC voltage tolerance 4      | FB w/r/t GND, $0^\circ\text{C} \leq T_A \leq 85^\circ\text{C}$ , with VOUT_ADJUSTMENT=13h and VOUT_MARGIN=07h for -5%      | -4.8 |      | 4.8  | mV            |
| <b>SMPS FREQUENCY</b>         |                              |  |      |      |      |               |
| $f_{SW}$                      | VO switching frequency       | $V_{IN} = 12\text{ V}$ , $V_{VO} = 3.3\text{ V}$ , FS<2:0> = 000   |      | 250  |      | kHz           |
|                               |                              | $V_{IN} = 12\text{ V}$ , $V_{VO} = 3.3\text{ V}$ , FS<2:0> = 001   |      | 300  |      |               |
|                               |                              | $V_{IN} = 12\text{ V}$ , $V_{VO} = 3.3\text{ V}$ , FS<2:0> = 010   |      | 400  |      |               |
|                               |                              | $V_{IN} = 12\text{ V}$ , $V_{VO} = 3.3\text{ V}$ , FS<2:0> = 011   |      | 500  |      |               |
|                               |                              | $V_{IN} = 12\text{ V}$ , $V_{VO} = 3.3\text{ V}$ , FS<2:0> = 100   |      | 600  |      |               |
|                               |                              | $V_{IN} = 12\text{ V}$ , $V_{VO} = 3.3\text{ V}$ , FS<2:0> = 101   |      | 750  |      |               |
|                               |                              | $V_{IN} = 12\text{ V}$ , $V_{VO} = 3.3\text{ V}$ , FS<2:0> = 110   |      | 850  |      |               |
|                               |                              | $V_{IN} = 12\text{ V}$ , $V_{VO} = 3.3\text{ V}$ , FS<2:0> = 111   |      | 1000 |      |               |
| $t_{ON(min)}$                 | Minimum on-time              | $T_A = 25^\circ\text{C}$ <sup>(3)</sup>  |      | 60   |      | ns            |
| $t_{OFF(min)}$                | Minimum off-time             | $T_A = 25^\circ\text{C}$   | 175  | 240  | 310  | ns            |
| <b>INTERNAL BOOTSTRAP SW</b>  |                              |  |      |      |      |               |
| $V_F$                         | Forward Voltage              | $V_{VREG-VBST}$ , $T_A = 25^\circ\text{C}$ , $I_F = 10\text{ mA}$  |      | 0.15 | 0.25 | V             |
| $I_{VBST}$                    | VBST leakage current         | $T_A = 25^\circ\text{C}$ , $V_{VBST} = 33\text{ V}$ , $V_{SW} = 28\text{ V}$   |      | 0.01 | 1.5  | $\mu\text{A}$ |
| <b>LOGIC THRESHOLD</b>        |                              |  |      |      |      |               |
| $V_{ENH}$                     | EN enable threshold voltage  |  | 1.3  | 1.4  | 1.5  | V             |
| $V_{ENL}$                     | EN disable threshold voltage |  | 1.1  | 1.2  | 1.3  | V             |
| $V_{ENHYST}$                  | EN hysteresis voltage        |  |      | 0.22 |      | V             |
| $V_{ENLEAK}$                  | EN input leakage current     |  | -1   | 0    | 1    | $\mu\text{A}$ |
| <b>SOFT-START</b>             |                              |  |      |      |      |               |
| $t_{SS}$                      | Soft-start time              | SST <1:0> = 00   |      | 1    |      | ms            |
|                               |                              | SST <1:0> = 01   |      | 2    |      |               |
|                               |                              | SST <1:0> = 10   |      | 4    |      |               |
|                               |                              | SST <1:0> = 11   |      | 8    |      |               |
| <b>POWERGOOD COMPARATOR</b>   |                              |  |      |      |      |               |
| $V_{PGTH}$                    | PGOOD threshold              | PGOOD in from higher   |      | 104% | 108% | 111%          |
|                               |                              | PGOOD in from lower  |      | 89%  | 92%  | 96%           |
|                               |                              | PGOOD out to higher  |      | 113% | 116% | 120%          |
|                               |                              | PGOOD out to lower   |      | 80%  | 84%  | 87%           |

(1) Tested at these VOUT\_ADJUSTMENT settings: -9.0%, -8.25%, -5.25%, -2.25%, 0.0%, 3.00%, 6.00%, 9.0%

(2) Tested at these VOUT\_MARGIN settings: -11.62%, -10.74%, -7.06%, -3.15%, 0%, 3.7%, 7.74%, 12.05%

(3) Specified by design. Not production tested.

**Electrical Characteristics (continued)**

over operating free-air temperature range,  $V_{REG} = 5\text{ V}$ ,  $V_{EN} = 5\text{ V}$  (unless otherwise noted)

| PARAMETER                |  | TEST CONDITIONS                             | MIN    | TYP   | MAX    | UNIT          |
|--------------------------|--|---|--------|-------|--------|---------------|
| $t_{PGDLY}$              | PGOOD delay time                                   | Delay for PGOOD going in PGD<2:0>=000       | 165    | 256   | 320    | $\mu\text{s}$ |
|                          |  | Delay for PGOOD going in PGD<2:0>=001       | 409    | 512   | 614    | $\mu\text{s}$ |
|                          |  | Delay for PGOOD going in PGD<2:0>=010       | 0.819  | 1.024 | 1.228  | ms            |
|                          |  | Delay for PGOOD going in PGD<2:0>=011       | 1.638  | 2.048 | 2.458  | ms            |
|                          |  | Delay for PGOOD going in PGD<2:0>=100       | 3.276  | 4.096 | 4.915  | ms            |
|                          |  | Delay for PGOOD going in PGD<2:0>=101       | 6.553  | 8.192 | 9.83   | ms            |
|                          |  | Delay for PGOOD going in PGD<2:0>=110       | 13.104 | 16.38 | 19.656 | ms            |
|                          |  | Delay for PGOOD going in PGD<2:0>=111       | 105    | 131   | 157    | ms            |
|                          |  | Delay tolerance for PGOOD coming out        |        | 2     |        | $\mu\text{s}$ |
| $I_{PG}$                 | PGOOD sink current                                 | $V_{PGOOD} = 0.5\text{ V}$                  | 4      | 6     |        | mA            |
| $I_{PGLK}$               | PGOOD leakage current                              | $V_{PGOOD} = 5.0\text{ V}$                  | -1     | 0     | 1      | $\mu\text{A}$ |
| <b>POWER-ON DELAY</b>    |  |   |        |       |        |               |
| $t_{PODLY}$              | Power-on delay time                                | Delay from enable to switching POD<2:0>=000 |        | 356   |        | $\mu\text{s}$ |
|                          |  | Delay from enable to switching POD<2:0>=001 |        | 612   |        | $\mu\text{s}$ |
|                          |  | Delay from enable to switching POD<2:0>=010 |        | 1.124 |        | ms            |
|                          |  | Delay from enable to switching POD<2:0>=011 |        | 2.148 |        | ms            |
|                          |  | Delay from enable to switching POD<2:0>=100 |        | 4.196 |        | ms            |
|                          |  | Delay from enable to switching POD<2:0>=101 |        | 8.292 |        | ms            |
|                          |  | Delay from enable to switching POD<2:0>=110 |        | 16.48 |        | ms            |
|                          |  | Delay from enable to switching POD<2:0>=111 |        | 32.86 |        | ms            |
| <b>CURRENT DETECTION</b> |  |   |        |       |        |               |
| $R_{TRIP}$               | TRIP pin resistance range                          |   | 20     |       | 70     | k $\Omega$    |
| $I_{OCL}$                | Current limit threshold, valley                    | $R_{TRIP} = 52.3\text{ k}\Omega$            | 10.1   | 12.0  | 13.9   | A             |
|                          |  | $R_{TRIP} = 38\text{ k}\Omega$              | 7.2    | 9.1   | 11.0   |               |
| $I_{OCLN}$               | Negative current limit threshold, valley           | $R_{TRIP} = 52.3\text{ k}\Omega$            | -15.3  | -11.9 | -8.5   | A             |
|                          |  | $R_{TRIP} = 38\text{ k}\Omega$              | -12    | -9    | -6     |               |
| $V_{ZC}$                 | Zero cross detection offset                        |   |        | 0     |        | mV            |
| <b>PROTECTIONS</b>       |  |   |        |       |        |               |
| $V_{VREGUVLO}$           | VREG undervoltage-lockout (UVLO) threshold voltage | Wake-up                                     | 3.25   | 3.34  | 3.41   | V             |
|                          |  | Shutdown                                    | 3.00   | 3.12  | 3.19   |               |
| $V_{VDDUVLO}$            | VDD UVLO threshold voltage                         | Wake-up (default)                           | 4.15   | 4.25  | 4.35   | V             |
|                          |  | Shutdown                                    | 3.95   | 4.05  | 4.15   |               |
| $V_{OVP}$                | Overshoot-protection (OVP) threshold voltage       | OVP detect voltage                          | 116%   | 120%  | 124%   |               |
| $t_{OVDPDY}$             | OVP propagation delay                              | With 100-mV overdrive                       |        | 300   |        | ns            |

**Electrical Characteristics (continued)**

 over operating free-air temperature range,  $V_{REG} = 5\text{ V}$ ,  $V_{EN} = 5\text{ V}$  (unless otherwise noted)

| PARAMETER  |   | TEST CONDITIONS   | MIN  | TYP  | MAX  | UNIT |
|--|---|---|------|------|------|------|
| $V_{UVP}$  | Undervoltage-protection (UVP) threshold voltage                           | UVP detect voltage  | 64%  | 68%  | 71%  |      |
| $t_{UVPDLY}$   | UVP delay   | UVP filter delay  |      | 1    |      | ms   |
| <b>THERMAL SHUTDOWN</b>                                |   |   |      |      |      |      |
| $T_{SDN}$  | Thermal shutdown threshold <sup>(3)</sup>                                 | Shutdown temperature  |      | 140  |      | °C   |
|  |   | Hysteresis  |      | 40   |      |      |
| <b>LDO VOLTAGE</b>                                     |   |   |      |      |      |      |
| $V_{REG}$  | LDO output voltage  | $V_{IN} = 12\text{ V}$ , $I_{LOAD} = 10\text{ mA}$  | 4.65 | 5    | 5.45 | V    |
| $V_{DOVREG}$   | LDO low droop drop-out voltage  | $V_{IN} = 4.5\text{ V}$ , $I_{LOAD} = 30\text{ mA}$ , $T_A = 25^\circ\text{C}$                                      |      |      | 365  | mV   |
| $I_{LDO MAX}$  | LDO over-current limit  | $V_{IN} = 12\text{ V}$ , $T_A = 25^\circ\text{C}$   | 170  | 200  |      | mA   |
| <b>INTERNAL MOSFETS</b>                                |   |   |      |      |      |      |
| $R_{DS(on)H}$  | High-side MOSFET on-resistance  | $T_A = 25^\circ\text{C}$  |      | 13.8 | 15.5 | mΩ   |
| $R_{DS(on)L}$  | Low-side MOSFET on-resistance   | $T_A = 25^\circ\text{C}$  |      | 5.9  | 7.0  | mΩ   |
| <b>PMBus SCL and SDA INPUT BUFFER LOGIC THRESHOLDS</b> |   |   |      |      |      |      |
| $V_{IL-PMBUS}$   | SCL and SDA low-level input voltage <sup>(3)</sup>                        | $0^\circ\text{C} \leq T_J \leq 85^\circ\text{C}$  |      |      | 0.8  | V    |
| $V_{IH-PMBUS}$   | SCL and SDA high-level input voltage <sup>(3)</sup>                       | $0^\circ\text{C} \leq T_J \leq 85^\circ\text{C}$  | 2.1  |      |      | V    |
| $V_{HY-PMBUS}$   | SCL and SDA hysteresis voltage <sup>(3)</sup>                             | $0^\circ\text{C} \leq T_J \leq 85^\circ\text{C}$  |      | 240  |      | mV   |
| <b>PMBus SDA and ALERT OUTPUT PULLDOWN</b>             |   |   |      |      |      |      |
| $V_{OL1-PMBUS}$  | SDA and $\overline{\text{ALERT}}$ low-level output voltage <sup>(3)</sup> | $V_{DDPMBUS} = 5.5\text{ V}$ , $R_{PULLUP} = 1.1\text{ k}\Omega$ , $0^\circ\text{C} \leq T_J \leq 85^\circ\text{C}$ |      |      | 0.4  | V    |
| $V_{OL2-PMBUS}$  | SDA and $\overline{\text{ALERT}}$ low-level output voltage <sup>(3)</sup> | $V_{DDPMBUS} = 3.6\text{ V}$ , $R_{PULLUP} = 0.7\text{ k}\Omega$ , $0^\circ\text{C} \leq T_J \leq 85^\circ\text{C}$ |      |      | 0.4  | V    |

## 6.6 Typical Characteristics

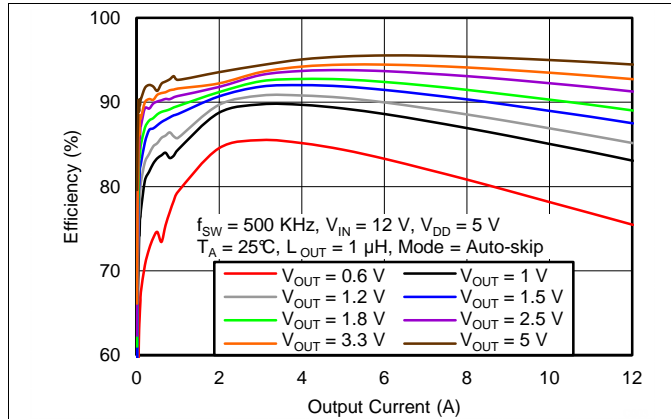

Figure 1. Efficiency vs. Output Current

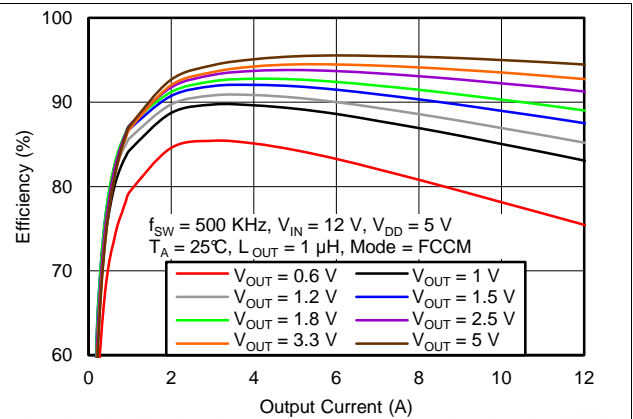

Figure 2. Efficiency vs. Output Current

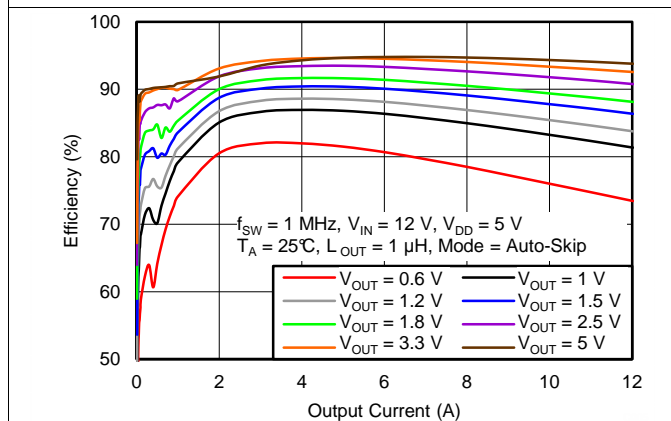

Figure 3. Efficiency vs. Output Current

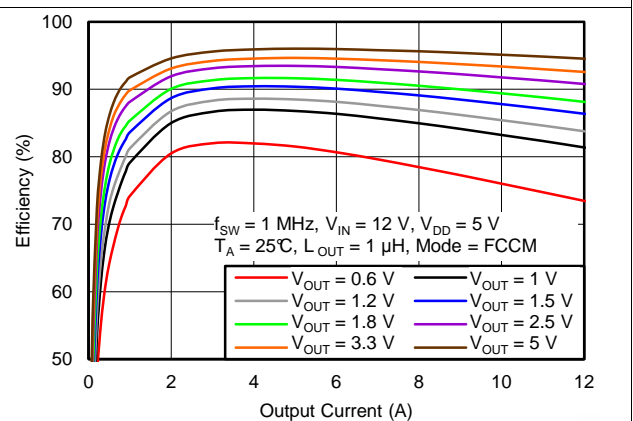

Figure 4. Efficiency vs. Output Current

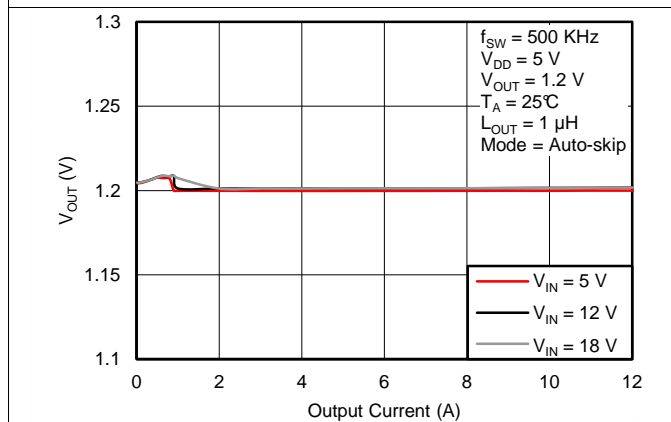

Figure 5. Output Voltage vs. Output Current

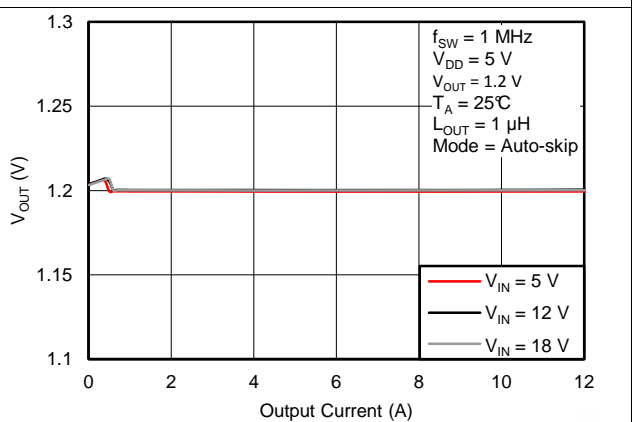
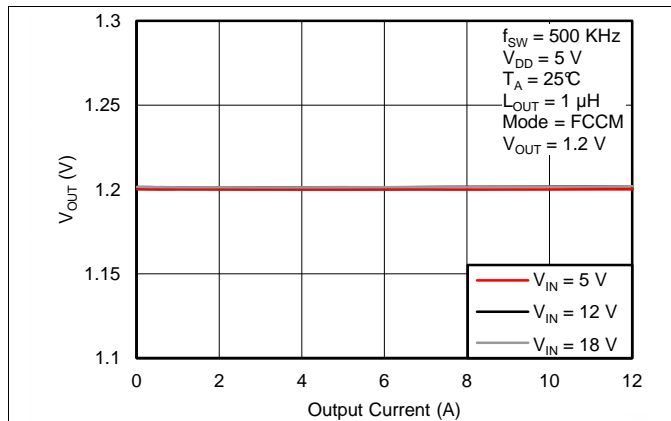
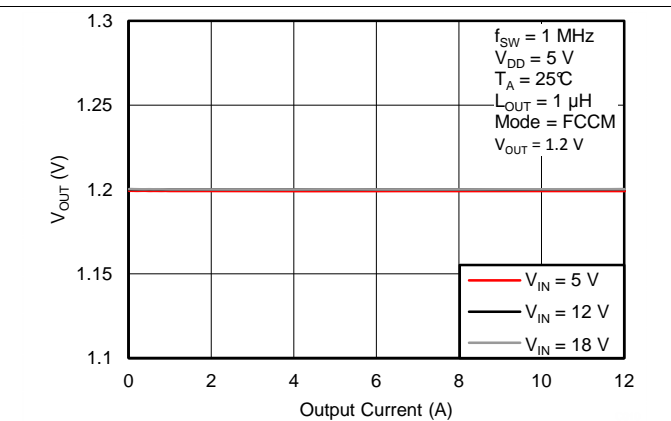
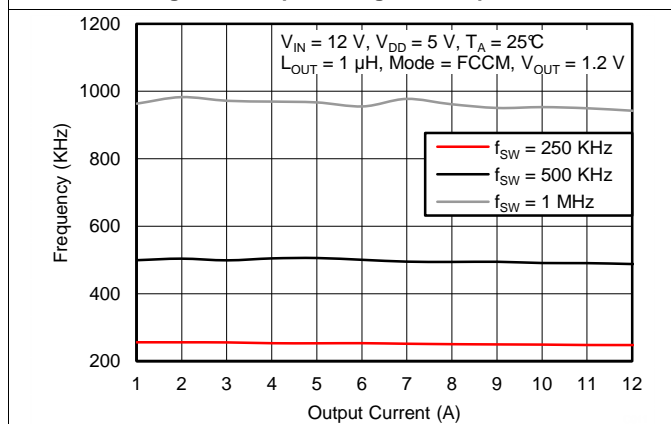
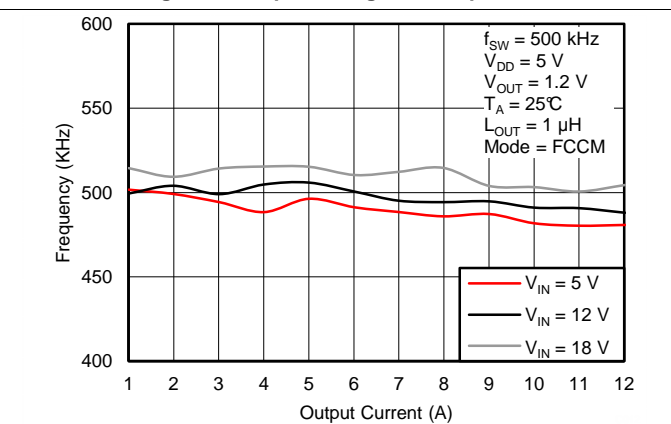
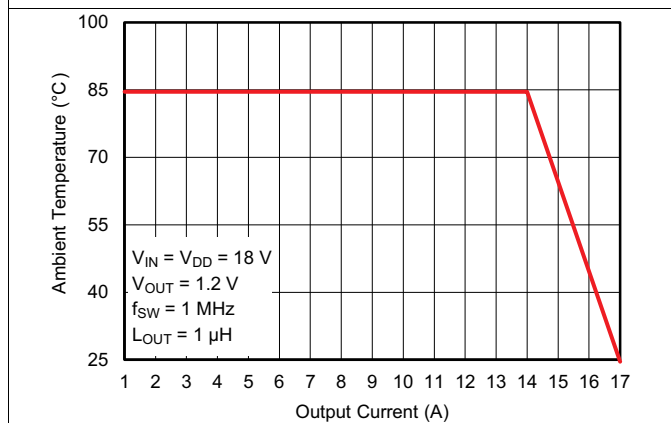
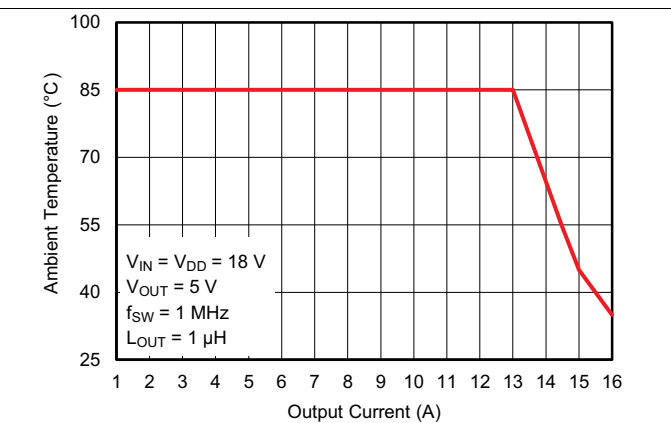

Figure 6. Output Voltage vs. Output Current



**Typical Characteristics (continued)**

**Figure 7. Output Voltage vs. Output Current**

**Figure 8. Output Voltage vs. Output Current**

**Figure 9. Switching Frequency vs. Output Current**

**Figure 10. Switching Frequency vs. Output Current**

**Figure 11. Safe Operating Area,  $V_{OUT} = 1.2 \text{ V}$** 

**Figure 12. Safe Operating Area,  $V_{OUT} = 5 \text{ V}$**

Typical Characteristics (continued)

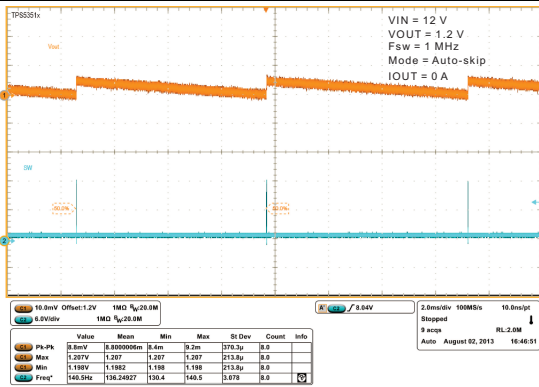

Figure 13. Auto-Skip Steady-State Operation

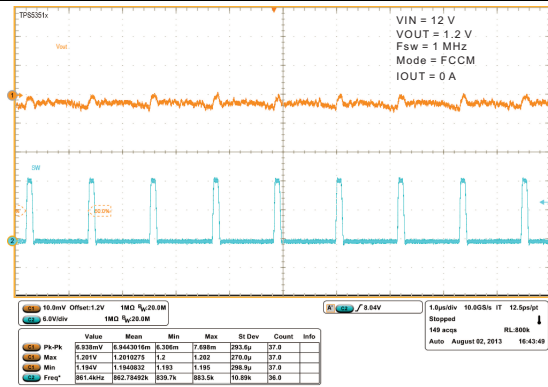

Figure 14. FCCM Steady-State Operation

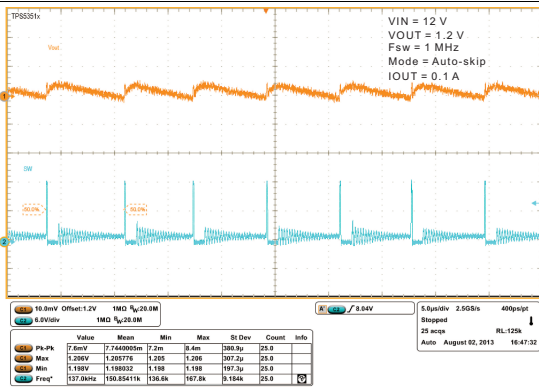

Figure 15. Auto-Skip Steady-State Operation

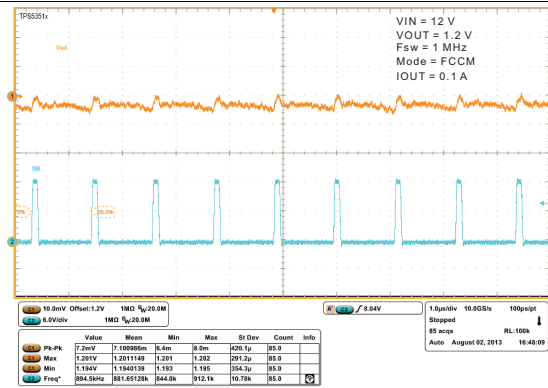

Figure 16. FCCM Steady-State Operation

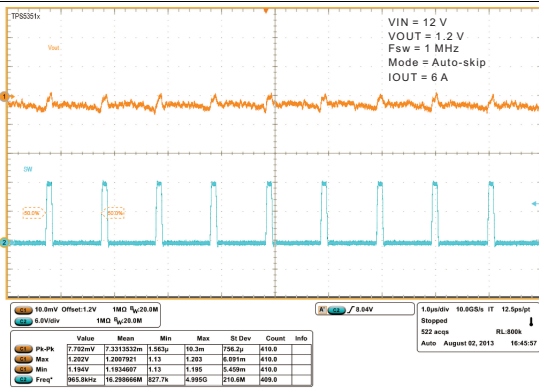

Figure 17. Auto-Skip Steady-State Operation

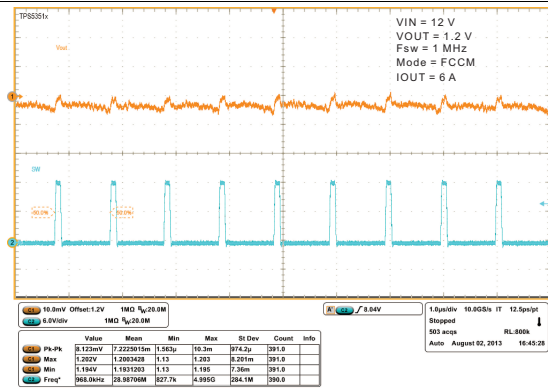

Figure 18. FCCM Steady-State Operation

Typical Characteristics (continued)

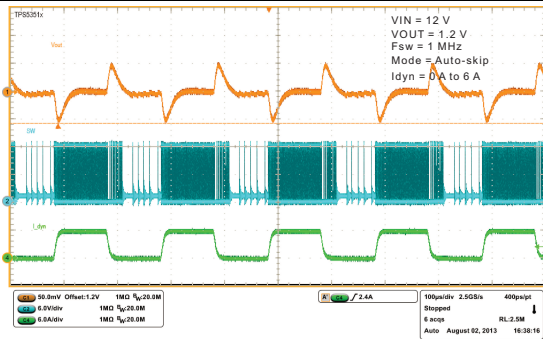

Figure 19. Auto-Skip Mode Load Transient

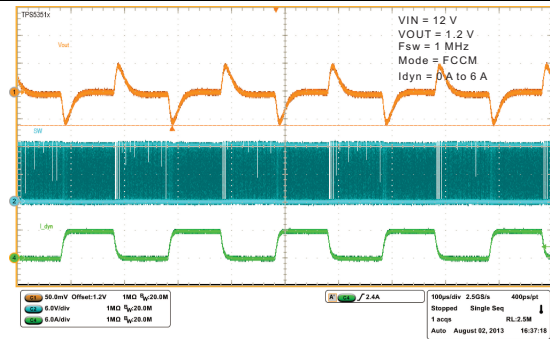

Figure 20. FCCM Mode Load Transient

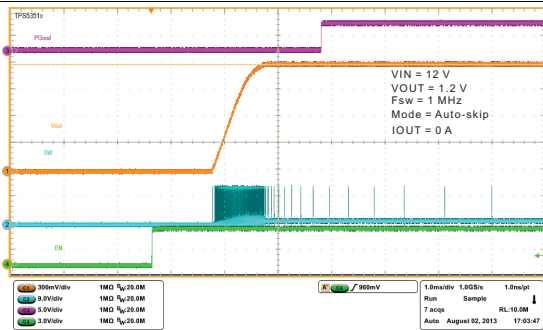

Figure 21. Start-Up

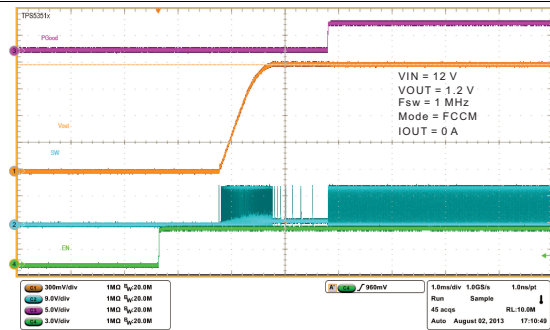

Figure 22. Start-Up

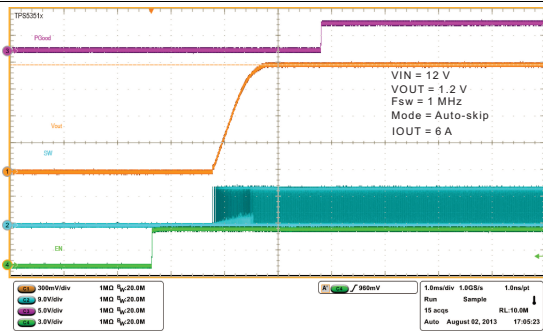

Figure 23. Start-Up

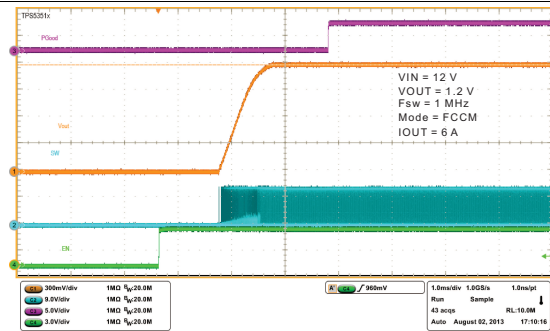

Figure 24. Start-Up

Typical Characteristics (continued)

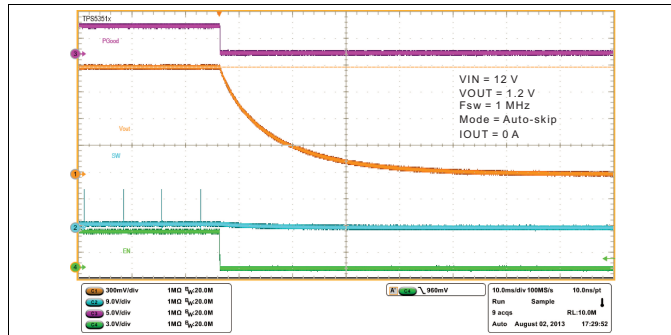

Figure 25. Shutdown Operation

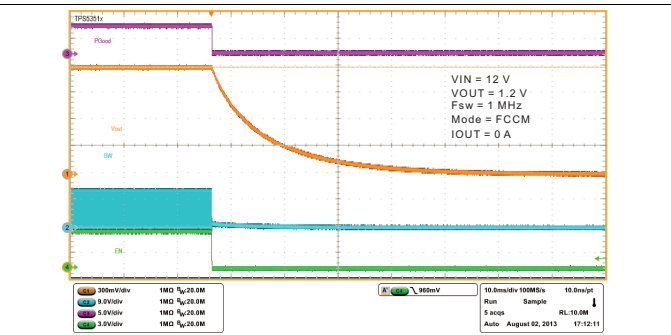

Figure 26. Shutdown Operation

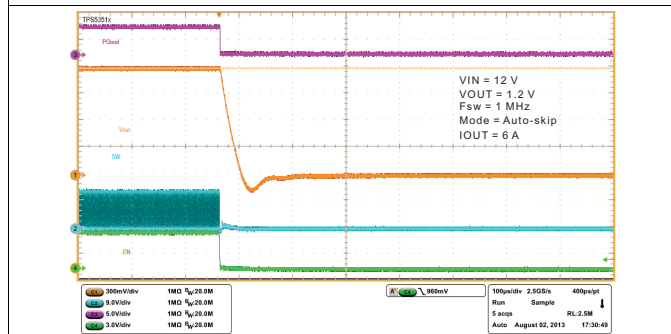

Figure 27. Shutdown Operation

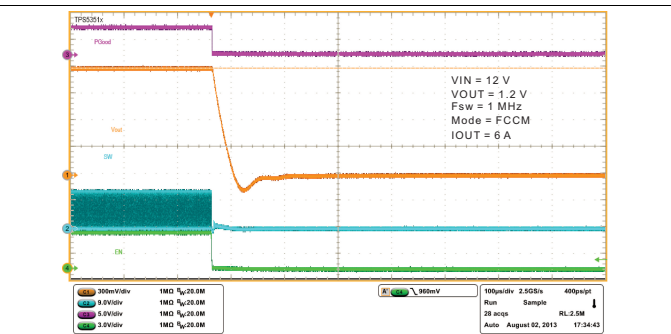

Figure 28. Shutdown Operation

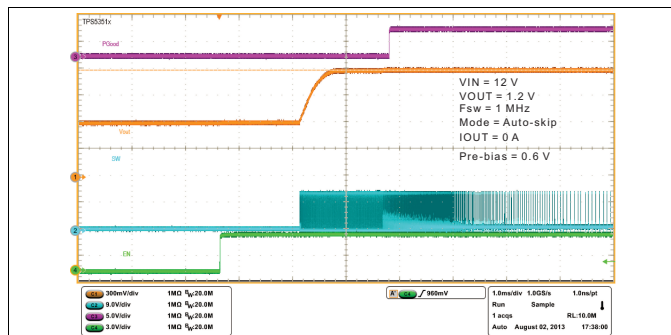

Figure 29. Pre-Bias Operation

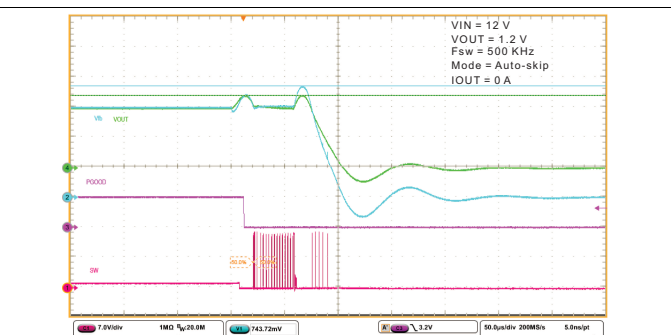

Figure 30. Overvoltage Protection

Typical Characteristics (continued)

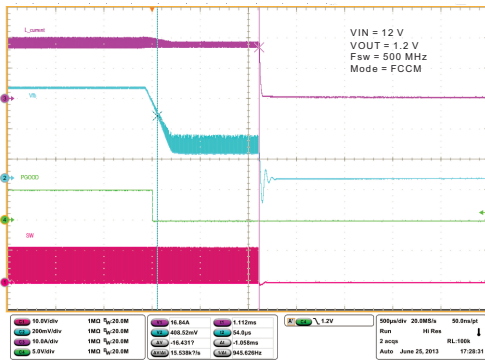

Figure 31. Overcurrent Protection



Figure 32. I<sup>2</sup>C READ (Address=31d, Cmd=0x79): ACK 0x10C8. I<sub>OC</sub> = 15 A

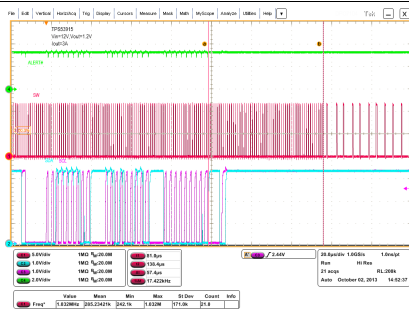

Figure 33. 1 MHz to 250 KHz

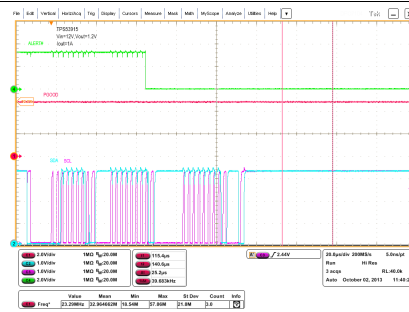

Figure 34. 31d\_FFh\_FFh

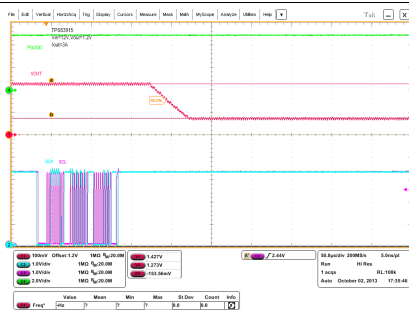
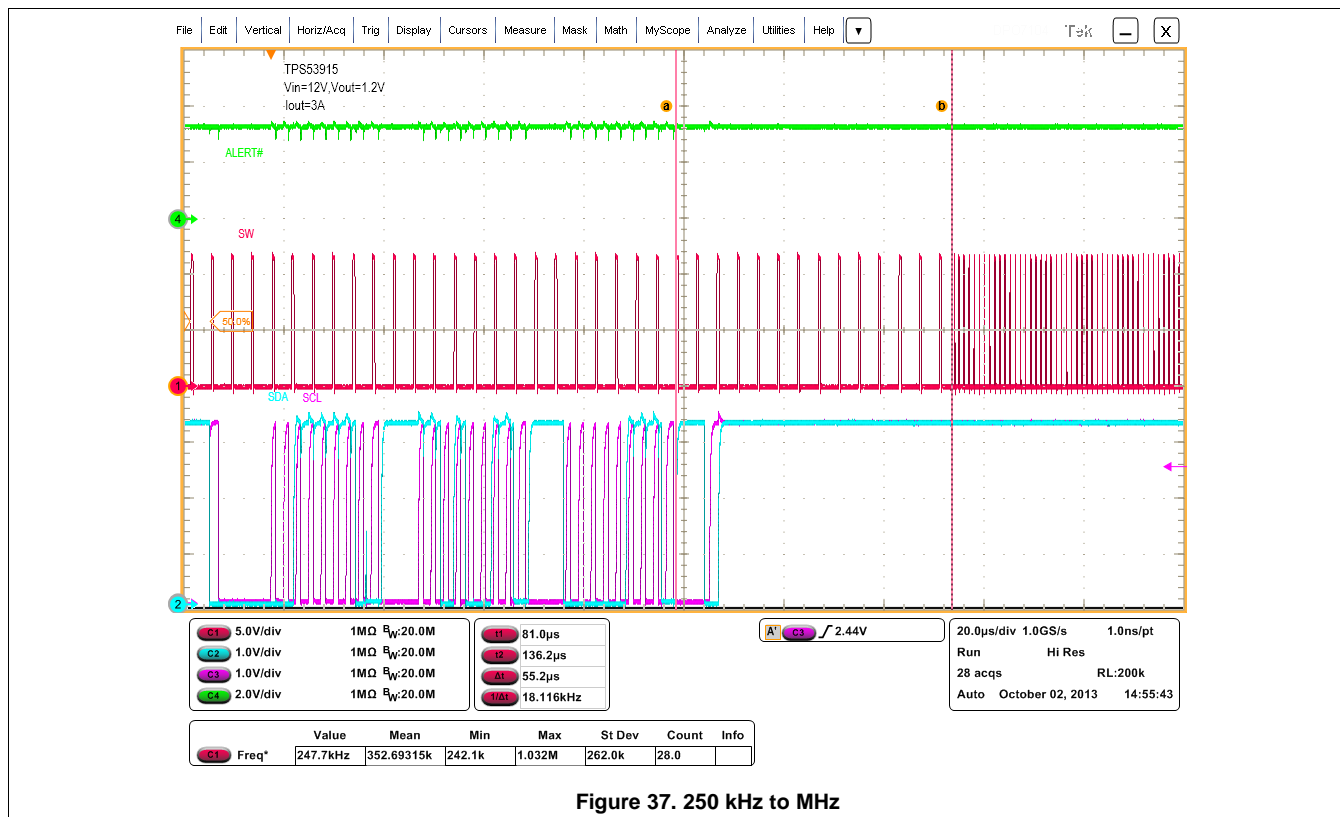

Figure 35. V<sub>OUT(adj)</sub> = 6%, V<sub>OMH</sub> = 12% to 0%



Figure 36. V<sub>OUT(adj)</sub> = 9%, V<sub>OMH</sub> = 0% to 12%

Typical Characteristics (continued)



6.7 Thermal Performance

$f_{SW} = 500 \text{ kHz}$ ,  $V_{IN} = 12 \text{ V}$ ,  $V_{OUT} = 5 \text{ V}$ ,  $I_{OUT} = 12 \text{ A}$ ,  $C_{OUT} = 10 \times 22 \mu\text{F}$  (1206, 6.3V, X5R),  $R_{BOOT} = 0 \Omega$ ,  $SNB = 3 \Omega + 470 \text{ pF}$   
 Inductor:  $L_{OUT} = 1 \mu\text{H}$ , PCMC135T-1R0MF, 12.6 mm x 13.8 mm x 5 mm, 2.1 mΩ (typ)

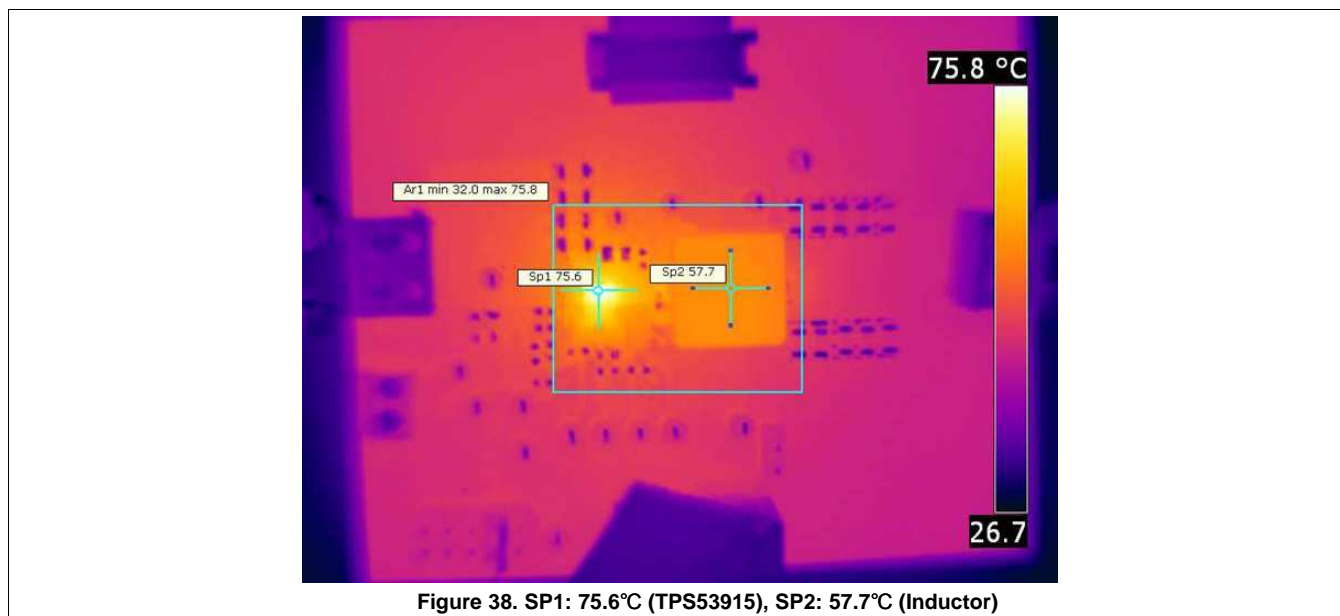

## 7 Detailed Description

### 7.1 Overview

The TPS53915 is a high-efficiency, single-channel, synchronous-buck converter. The device suits low-output voltage point-of-load applications with 12-A or lower output current in computing and similar digital consumer applications. The TPS53915 features proprietary D-CAP3 mode control combined with adaptive on-time architecture. This combination builds modern low-duty-ratio and ultra-fast load-step-response DC-DC converters in an ideal fashion. The output voltage ranges from 0.6 V to 5.5 V. The conversion input voltage ranges from 1.5 V to 18 V and the VDD input voltage ranges from 4.5 V to 25 V. The D-CAP3 mode uses emulated current information to control the modulation. An advantage of this control scheme is that it does not require a phase-compensation network outside which makes the device easy-to-use and also allows low-external component count. Adaptive on-time control tracks the preset switching frequency over a wide range of input and output voltage while increasing switching frequency as needed during load-step transient.



## 7.2 Functional Block Diagrams

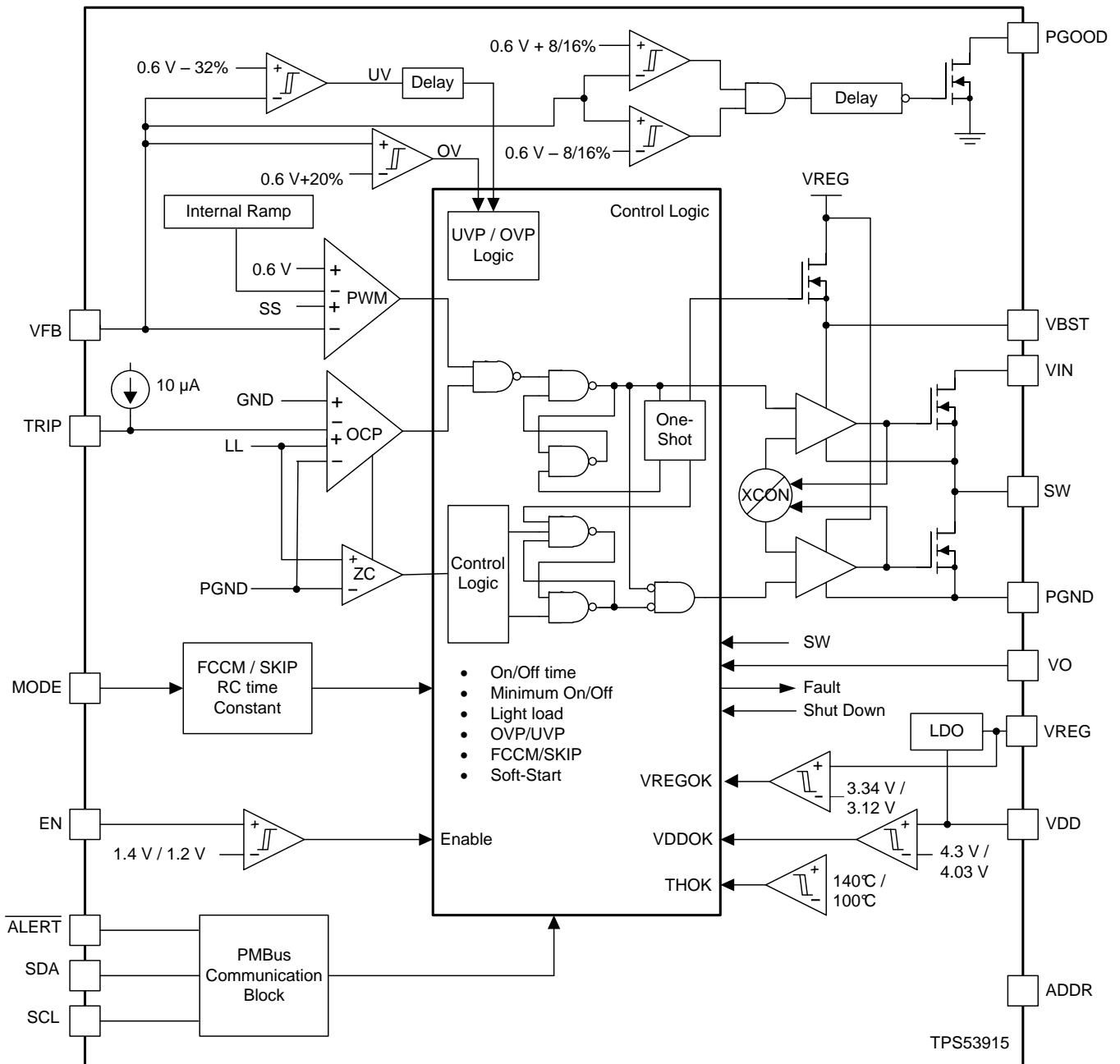

## 7.3 Feature Description

### 7.3.1 Powergood

The TPS53915 has powergood output that indicates high when switcher output is within the target. The power-good function is activated after the soft-start operation is complete. If the output voltage becomes within  $\pm 8\%$  of the target value, internal comparators detect the power-good state and the power-good signal becomes high after a 1-ms internal delay. If the output voltage goes outside of  $\pm 16\%$  of the target value, the power-good signal becomes low after a 2- $\mu$ s internal delay. The power-good output is an open-drain output and must be pulled-up externally.

## Feature Description (continued)

### 7.3.2 D-CAP3 Control and Mode Selection

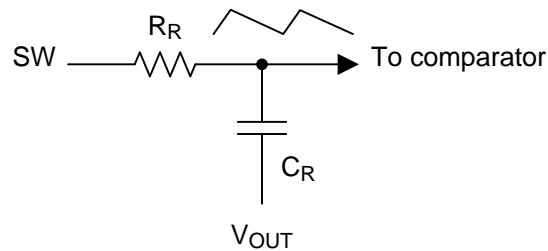

**Figure 39. Internal RAMP Generation Circuit**

The TPS53915 uses D-CAP3 mode control to achieve fast load transient while maintaining the ease-of-use feature. An internal RAMP is generated and fed to the VFB pin to reduce jitter and maintain stability. The amplitude of the ramp is determined by the R-C time-constant as shown in Figure 39. At different switching frequencies, ( $f_{SW}$ ) the R-C time-constant varies to maintain relatively constant RAMP amplitude.

The default switching frequency ( $f_{SW}$ ) is pre-set at 400 kHz. The switching frequency can be changed via PMBus function (see Table 13).

### 7.3.3 D-CAP3 Mode

From small-signal loop analysis, a buck converter using the D-CAP3 mode control architecture can be simplified as shown in Figure 40.

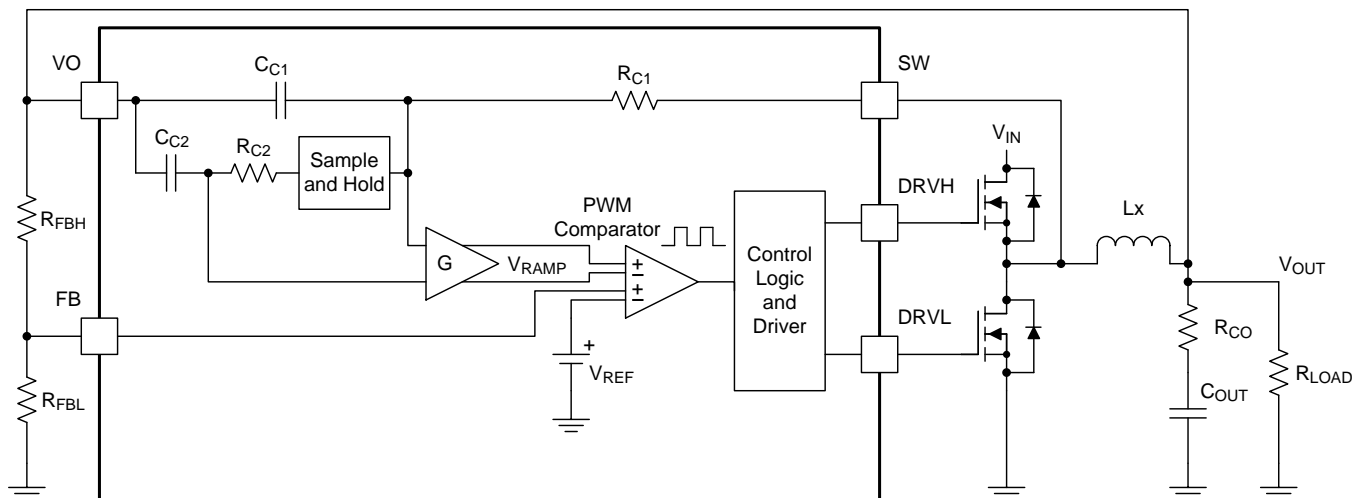

**Figure 40. D-CAP3 Mode**

The D-CAP3 control architecture includes an internal ripple generation network enabling the use of very low-ESR output capacitors such as multi-layered ceramic capacitors (MLCC). No external current sensing network or voltage compensators are required with D-CAP3 control architecture. The role of the internal ripple generation network is to emulate the ripple component of the inductor current information and then combine it with the voltage feedback signal to regulate the loop operation. For any control topologies supporting no external compensation design, there is a minimum and/or maximum range of the output filter it can support. The output filter used with the TPS53513 is a lowpass L-C circuit. This L-C filter has double pole that is described in Equation 1.

$$f_p = \frac{1}{2 \times \pi \times \sqrt{L_{OUT} \times C_{OUT}}} \quad (1)$$

## Feature Description (continued)

At low frequencies, the overall loop gain is set by the output set-point resistor divider network and the internal gain of the TPS53513. The low frequency L-C double pole has a 180 degree in phase. At the output filter frequency, the gain rolls off at a –40dB per decade rate and the phase drops rapidly. The internal ripple generation network introduces a high-frequency zero that reduces the gain roll off from –40dB to –20dB per decade and increases the phase to 90 degree one decade above the zero frequency.

The inductor and capacitor selected for the output filter must be such that the double pole of [Equation 1](#) is located close enough to the high-frequency zero so that the phase boost provided by the high-frequency zero provides adequate phase margin for the stability requirement.

**Table 1. Locating the Zero**

| SWITCHING FREQUENCIES ( $f_{SW}$ ) (kHz) | ZERO ( $f_z$ ) LOCATION (kHz) |
|--|-------------------------------|
| 250 and 300                              | 6                             |
| 400 and 500                              | 7                             |
| 600 and 750                              | 9                             |
| 850 and 1000                             | 12                            |

After identifying the application requirements, the output inductance should be designed so that the inductor peak-to-peak ripple current is approximately between 25% and 35% of the  $I_{CC(max)}$  (peak current in the application). Use [Table 1](#) to help locate the internal zero based on the selected switching frequency. In general, where reasonable (or smaller) output capacitance is desired, [Equation 2](#) can be used to determine the necessary output capacitance for stable operation.

$$f_p = \frac{1}{2 \times \pi \times \sqrt{L_{OUT} \times C_{OUT}}} = f_z \quad (2)$$

If MLCC is used, consider the derating characteristics to determine the final output capacitance for the design. For example, when using an MLCC with specifications of 10- $\mu$ F, X5R and 6.3 V, the deratings by DC bias and AC bias are 80% and 50% respectively. The effective derating is the product of these two factors, which in this case is 40% and 4- $\mu$ F. Consult with capacitor manufacturers for specific characteristics of the capacitors to be used in the system/applications.

[Table 2](#) shows the recommended output filter range for an application design with the following specifications:

- Input voltage,  $V_{IN} = 12$  V
- Switching frequency,  $f_{SW} = 600$  kHz
- Output current,  $I_{OUT} = 8$  A

The minimum output capacitance is verified by the small signal measurement conducted on the EVM using the following two criteria:

- Loop crossover frequency is less than one-half the switching frequency (300 kHz)
- Phase margin at the loop crossover is greater than 50 degrees

For the maximum output capacitance recommendation, simplify the procedure to adopt an unrealistically high output capacitance for this type of converter design, then verify the small signal response on the EVM using the following one criteria:

- Phase margin at the loop crossover is greater than 50 degrees

As indicated by the phase margin, the actual maximum output capacitance ( $C_{OUT(max)}$ ) can continue to go higher. However, small signal measurement (bode plot) should be done to confirm the design.

Select a MODE pin configuration as shown in [Table 3](#) to double the R-C time constant option for the maximum output capacitance design and application. Select a MODE pin configuration to use single R-C time constant option for the normal (or smaller) output capacitance design and application.

The MODE pin also selects SKIP-mode or FCCM-mode operation.

**Table 2. Recommended Component Values**

| V <sub>OUT</sub> (V) | R <sub>LOWER</sub> (kΩ) | R <sub>UPPER</sub> (kΩ) | L <sub>OUT</sub> (μH)  | C <sub>OUT(min)</sub> (μF) <sup>(1)</sup> | CROSS-OVER (kHz) | PHASE MARGIN (°) | C <sub>OUT(max)</sub> (μF) <sup>(1)</sup> | INTERNAL RC SETTING (μs) | INDUCTOR ΔI/I <sub>CC(max)</sub> | I <sub>CC(max)</sub> (A) |
|----------------------|-------------------------|-------------------------|------------------------|---|------------------|------------------|---|--------------------------|----------------------------------|--------------------------|
| 0.6                  | 10                      | 0                       | 0.36<br>PIMB065T-R36MS | 3 × 100                                   | 247              | 70               |   | 40                       | 33%                              | 8                        |
|                      |                         |                         |                        |   |                  |                  | 48  | 62                       |                                  |                          |
| 1.2                  |                         | 10                      | 0.68<br>PIMB065T-R68MS | 9 × 22                                    | 207              | 53               |   | 40                       | 33%                              |                          |
|                      |                         |                         |                        |   |                  |                  | 25  | 84                       |                                  |                          |
| 2.5                  |                         | 31.6                    | 1.2<br>PIMB065T-1R2MS  | 4 × 22                                    | 185              | 57               |   | 40                       | 34%                              |                          |
|                      |                         |                         |                        |   |                  |                  | 11  | 63                       |                                  |                          |
| 3.3                  |                         | 45.3                    | 1.5<br>PIMB065T-1R5MS  | 3 × 22                                    | 185              | 57               |   | 40                       | 33%                              |                          |
|                      |                         |                         |                        |   |                  |                  | 9   | 59                       |                                  |                          |
| 5.5                  |                         | 82.5                    | 2.2<br>PIMB065T-2R2MS  | 2 × 22                                    | 185              | 51               |   | 40                       | 28%                              |                          |
|                      |                         |                         |                        |   |                  |                  | 7   | 58                       |                                  |                          |

(1) All C<sub>OUT(min)</sub> and C<sub>OUT(max)</sub> capacitor specifications are 1206, X5R, 10 V.

For higher output voltage at or above 2.0 V, additional phase boost might be required in order to secure sufficient phase margin due to phase delay/loss for higher output voltage (large on-time (t<sub>ON</sub>)) setting in a fixed on time topology based operation.

A feedforward capacitor placing in parallel with R<sub>UPPER</sub> is found to be very effective to boost the phase margin at loop crossover.

**Table 3. Mode Selection and Internal RAMP RC Time Constant**

| MODE SELECTION            | ACTION           | R <sub>MODE</sub> (kΩ) | R-C TIME CONSTANT (μs) | SWITCHING FREQUENCIES f <sub>sw</sub> (kHz) |
|---------------------------|------------------|------------------------|------------------------|---|
| <b>Skip Mode</b>          | Pull down to GND | 0                      | 60                     | 275 and 325                                 |
|                           |                  |                        | 50                     | 425 and 525                                 |
|                           |                  |                        | 40                     | 625 and 750                                 |
|                           |                  |                        | 30                     | 850 and 1000                                |
|                           |                  | 150                    | 120                    | 275 and 325                                 |
|                           |                  |                        | 100                    | 425 and 525                                 |
|                           |                  |                        | 80                     | 625 and 750                                 |
|                           |                  |                        | 60                     | 850 and 1000                                |
| <b>FCCM<sup>(1)</sup></b> | Connect to PGOOD | 20                     | 60                     | 275 and 325                                 |
|                           |                  |                        | 50                     | 425 and 525                                 |
|                           |                  |                        | 40                     | 625 and 750                                 |
|                           |                  |                        | 30                     | 850 and 1000                                |
|                           |                  | 150                    | 120                    | 275 and 325                                 |
|                           |                  |                        | 100                    | 425 and 525                                 |
|                           |                  |                        | 80                     | 625 and 750                                 |
|                           |                  |                        | 60                     | 850 and 1000                                |
| <b>FCCM</b>               | Connect to VREG  | 0                      | 120                    | 275 and 325                                 |
|                           |                  |                        | 100                    | 425 and 525                                 |
|                           |                  |                        | 80                     | 625 and 750                                 |
|                           |                  |                        | 60                     | 850 and 1000                                |

(1) Device goes into Forced CCM (FCCM) after PGOOD becomes high.

7.3.4 Sample and Hold Circuitry

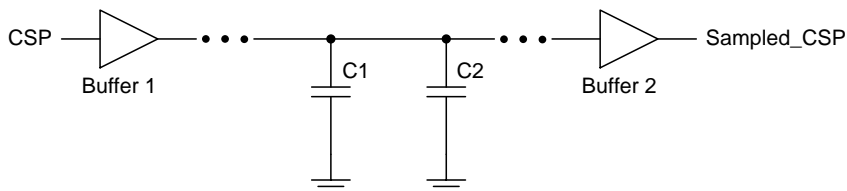
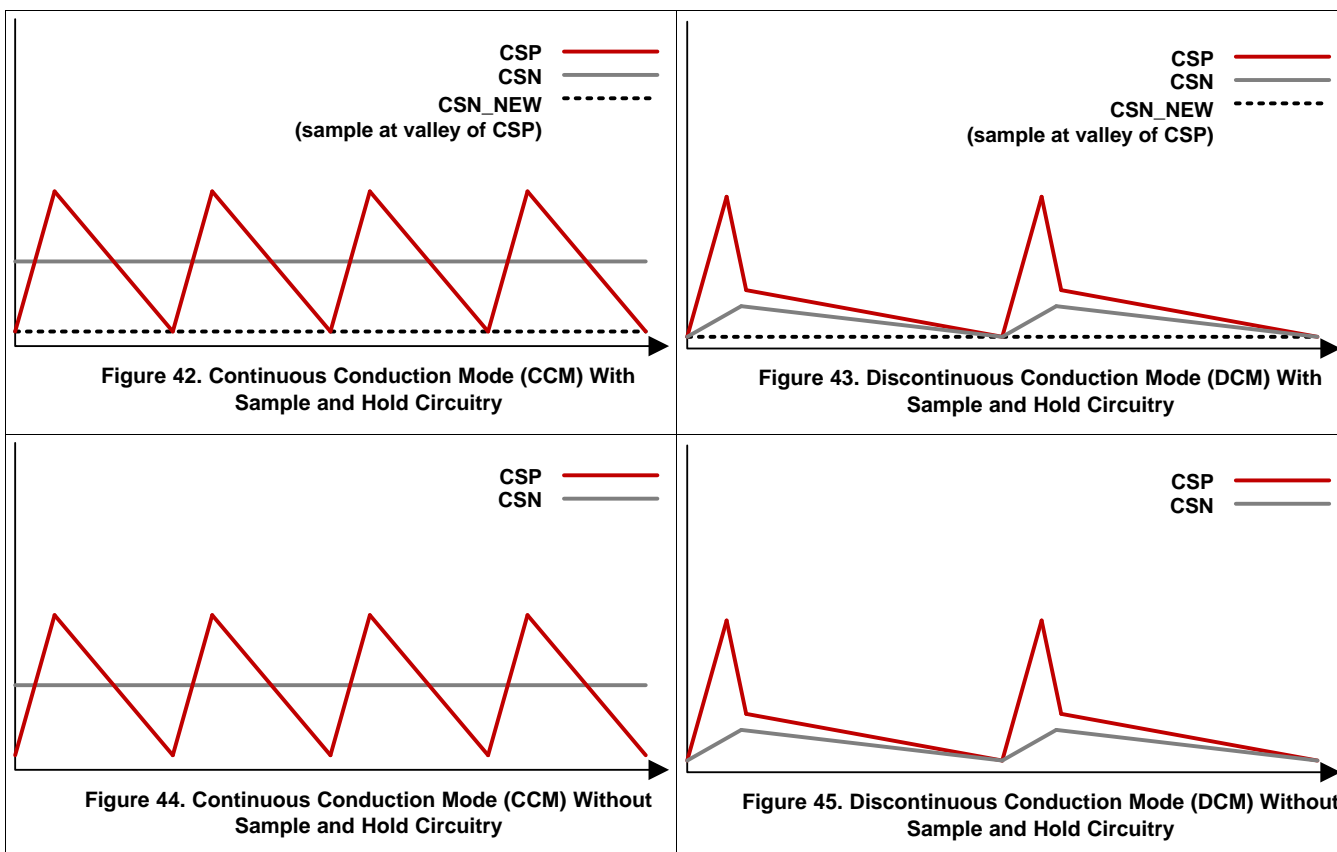
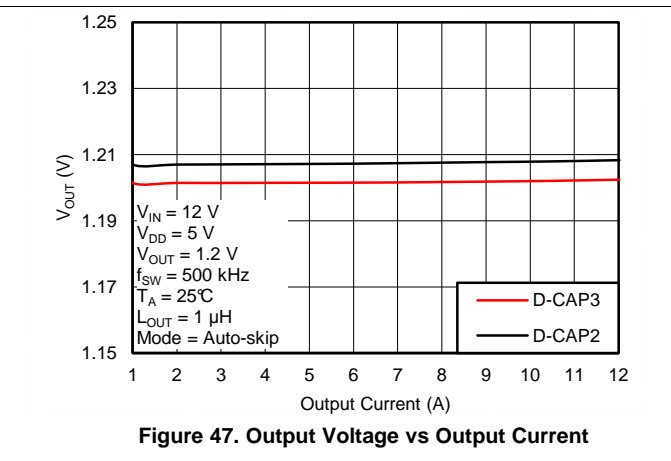
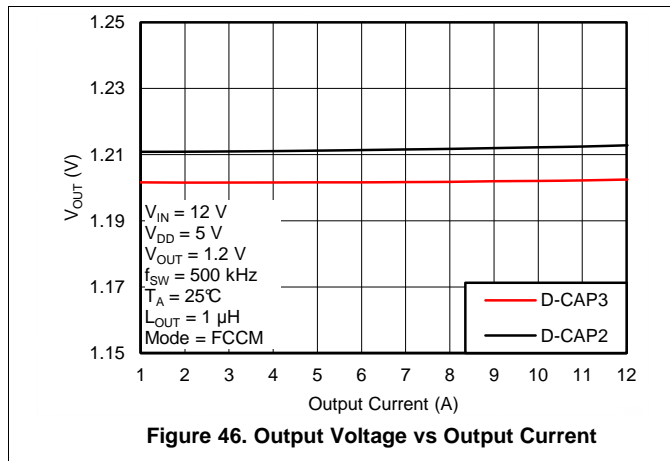

Figure 41. Sample and Hold Circuitry (Patent Pending)

The sample and hold circuitry is the difference between D-CAP3 and D-CAP2. The sample and hold circuitry, which is an advance control scheme to boost output voltage accuracy higher on the TPS53915, is one of features of the TPS53915. The sample and hold circuitry generates a new DC voltage of CSN instead of the voltage which is produced by  $R_{C2}$  and  $C_{C2}$  which allows for tight output-voltage accuracy and makes the TPS53915 more competitive.





### 7.3.5 Adaptive Zero-Crossing

The TPS53915 uses an adaptive zero-crossing circuit to perform optimization of the zero inductor-current detection during skip-mode operation. This function allows ideal low-side MOSFET turn-off timing. The function also compensates the inherent offset voltage of the Z-C comparator and delay time of the Z-C detection circuit. Adaptive zero-crossing prevents SW-node swing-up caused by too-late detection and minimizes diode conduction period caused by too-early detection. As a result, the device delivers better light-load efficiency.

### 7.3.6 Forced Continuous-Conduction Mode

When the MODE pin is tied to the PGOOD pin through a resistor, the controller operates in continuous conduction mode (CCM) during light-load conditions. During CCM, the switching frequency maintained to an almost constant level over the entire load range which is suitable for applications requiring tight control of the switching frequency at the cost of lower efficiency.

### 7.3.7 Current Sense and Overcurrent Protection

The TPS53915 has cycle-by-cycle overcurrent limiting control. The inductor current is monitored during the OFF state and the controller maintains the OFF state during the period that the inductor current is larger than the overcurrent trip level. In order to provide good accuracy and a cost-effective solution, the TPS53915 supports temperature compensated MOSFET  $R_{DS(on)}$  sensing. Connect the TRIP pin to GND through the trip-voltage setting resistor,  $R_{TRIP}$ . The TRIP terminal sources  $I_{TRIP}$  current, which is 10  $\mu$ A typically at room temperature, and the trip level is set to the OCL trip voltage  $V_{TRIP}$  as shown in [Equation 3](#).

$$V_{TRIP} = R_{TRIP} \times I_{TRIP}$$

where

- $V_{TRIP}$  is in mV
- $R_{TRIP}$  is in k $\Omega$
- $I_{TRIP}$  is in  $\mu$ A

(3)

[Equation 4](#) calculates the typical DC OCP level (typical low-side on-resistance [ $R_{DS(on)}$ ] of 5.9 m $\Omega$  should be used); in order to design for worst case minimum OCP, maximum low-side on-resistance value of 8 m $\Omega$  should be used. The inductor current is monitored by the voltage between the GND pin and SW pin so that the SW pin is properly connected to the drain terminal of the low-side MOSFET.  $I_{TRIP}$  has a 3000-ppm/ $^{\circ}$ C temperature slope to compensate the temperature dependency of  $R_{DS(on)}$ . The GND pin acts as the positive current-sensing node. Connect the GND pin to the proper current sensing device, (for example, the source terminal of the low-side MOSFET.)

Because the comparison occurs during the OFF state,  $V_{TRIP}$  sets the valley level of the inductor current. Thus, the load current at the overcurrent threshold,  $I_{OCP}$ , is calculated as shown in [Equation 4](#).

$$I_{OCP} = \frac{V_{TRIP}}{(8 \times R_{DS(on)})} + \frac{I_{IND(ripple)}}{2} = \frac{V_{TRIP}}{(8 \times R_{DS(on)L})} + \frac{1}{2 \times L \times f_{SW}} \times \frac{(V_{IN} - V_{OUT}) \times V_{OUT}}{V_{IN}}$$

where

- $R_{DS(on)}$  is the on-resistance of the low-side MOSFET
  - $R_{TRIP}$  is in  $k\Omega$
- (4)

In an overcurrent condition, the current to the load exceeds the current to the output capacitor thus the output voltage tends to decrease. Eventually, the output voltage crosses the undervoltage-protection threshold and shuts down.

### 7.3.8 Overvoltage and Undervoltage Protection

The TPS53915 monitors a resistor-divided feedback voltage to detect overvoltage and undervoltage. When the feedback voltage becomes lower than 68% of the target voltage, the UVP comparator output goes high and an internal UVP delay counter begins counting. After 1 ms, the TPS53915 latches OFF both high-side and low-side MOSFETs drivers. The UVP function enables after soft-start is complete.

When the feedback voltage becomes higher than 120% of the target voltage, the OVP comparator output goes high and the circuit latches OFF the high-side MOSFET driver and turns on the low-side MOSFET until reaching a negative current limit. Upon reaching the negative current limit, the low-side FET is turned off and the high-side FET is turned on again for a minimum on-time. The TPS53915 operates in this cycle until the output voltage is pulled down under the UVP threshold voltage for 1 ms. After the 1-ms UVP delay time, the high-side FET is latched off and low-side FET is latched on. The fault is cleared with a reset of VDD or by re-toggling EN pin.

### 7.3.9 Out-Of-Bounds Operation (OOB)

The TPS53915 has an out-of-bounds (OOB) overvoltage protection that protects the output load at a much lower overvoltage threshold of 8% above the target voltage. OOB protection does not trigger an overvoltage fault, so the device is not latched off after an OOB event. OOB protection operates as an early no-fault overvoltage-protection mechanism. During the OOB operation, the controller operates in forced PWM mode only by turning on the low-side FET. Turning on the low-side FET beyond the zero inductor current quickly discharges the output capacitor thus causing the output voltage to fall quickly towards the setpoint. During the operation, the cycle-by-cycle negative current limit is also activated to ensure the safe operation of the internal FETs.

### 7.3.10 UVLO Protection

The TPS53915 monitors the voltage on the VDD pin. If the VDD pin voltage is lower than the UVLO off-threshold voltage, the switch mode power supply shuts off. If the VDD voltage increases beyond the UVLO on-threshold voltage, the controller turns back on. UVLO is a non-latch protection.

### 7.3.11 Thermal Shutdown

The TPS53915 monitors internal temperature. If the temperature exceeds the threshold value (typically 140°C), TPS53915 shuts off. When the temperature falls approximately 40°C below the threshold value, the device turns on. Thermal shutdown is a non-latch protection.

## 7.4 Device Functional Modes

### 7.4.1 Auto-Skip Eco-Mode Light-Load Operation

While the MODE pin is pulled to GND directly or through a 150-k $\Omega$  resistor, the TPS53915 device automatically reduces the switching frequency at light-load conditions to maintain high efficiency. This section describes the operation in detail.

As the output current decreases from heavy-load condition, the inductor current also decreases until the rippled valley of the inductor current touches zero level. Zero level is the boundary between the continuous-conduction and discontinuous-conduction modes. The synchronous MOSFET turns off when this zero inductor current is detected. As the load current decreases further, the converter runs into discontinuous-conduction mode (DCM). The on-time is maintained to a level approximately the same as during continuous-conduction mode operation so that discharging the output capacitor with a smaller load current to the level of the reference voltage requires more time. The transition point to the light-load operation  $I_{O(LL)}$  (for example: the threshold between continuous- and discontinuous-conduction mode) is calculated as shown in [Equation 5](#).

$$I_{OUT(LL)} = \frac{1}{2 \times L \times f_{SW}} \times \frac{(V_{IN} - V_{OUT}) \times V_{OUT}}{V_{IN}}$$



## Device Functional Modes (continued)

where

- $f_{SW}$  is the PWM switching frequency (5)

TI recommends only using ceramic capacitors for Auto-skip mode.

### 7.4.2 Forced Continuous-Conduction Mode

When the MODE pin is tied to the PGOOD pin through a resistor, the controller operates in continuous conduction mode (CCM) during light-load conditions. During CCM, the switching frequency maintained to an almost constant level over the entire load range which is suitable for applications requiring tight control of the switching frequency at the cost of lower efficiency.

## 7.5 Programming

### 7.5.1 The PMBus General Descriptions

The TPS53915 has seven internal custom user-accessible 8-bit registers. The PMBus interface has been designed for program flexibility, supporting a direct format for write operation. Read operations are supported for both combined format and stop separated format. While there is no auto increment/decrement capability in the TPS53915 PMBus logic, a tight software loop can be designed to randomly access the next register, regardless of which register was accessed first. The START and STOP commands frame the data packet and the REPEAT START condition is allowed when necessary.

The device can operate in either standard mode (100 kb/s) or fast mode (400 kb/s).

### 7.5.2 PMBus Slave Address Selection

The seven-bit slave address is  $001A_3A_2A_1A_0x$ , where  $A_3A_2A_1A_0$  is set by the ADDR pin on the device. Bit 0 is the data direction bit, i.e.,  $001A_3A_2A_1A_00$  is used for write operation and  $001A_3A_2A_1A_01$  is used for read operation.

### 7.5.3 PMBus Address Selection

The TPS53915 allows up to 16 different chip addresses for PMBus communication, with the first three bits fixed as 001. The address selection process is defined by the resistor divider ratio from VREG pin to ADDR pin, and the address detection circuit starts to work only after VDD input supply has risen above its UVLO threshold. The table below lists the divider ratio and some example resistor values. The 1% tolerance resistors with typical temperature coefficient of  $\pm 100$  ppm/°C are recommended. Higher performance resistors can be used if tighter noise margin is required for more reliable address detection, as shown in [Table 4](#).

**Table 4. PMBus Address Selection Settings**

| PMBus ADDRESS | RESISTOR DIVIDER RATIO ( $\Omega$ ) |        |        | $(R_{HIGH})$ (k $\Omega$ )<br>HIGH-SIDE<br>RESISTOR | $(R_{LOW})$ (k $\Omega$ )<br>LOW-SIDE<br>RESISTOR |
|---------------|-------------------------------------|--------|--------|---|---|
|               | $(R_{LOW}/R_{LOW}+R_{HIGH})$        | MIN    | MAX    |   |   |
| 0011111       | > 0.557                             |        |        | 1   | 300   |
| 0011110       | 0.5100                              | 0.4958 | 0.5247 | 160   | 165   |
| 0011101       | 0.4625                              | 0.4482 | 0.4772 | 180   | 154   |
| 0011100       | 0.4182                              | 0.4073 | 0.4294 | 200   | 143   |
| 0011011       | 0.3772                              | 0.3662 | 0.3886 | 200   | 120   |
| 0011010       | 0.3361                              | 0.3249 | 0.3476 | 220   | 110   |
| 0011001       | 0.2985                              | 0.2905 | 0.3067 | 249   | 105   |
| 0011000       | 0.2641                              | 0.2560 | 0.2725 | 249   | 88.7  |
| 0010111       | 0.2298                              | 0.2215 | 0.2385 | 240   | 71.5  |
| 0010110       | 0.1955                              | 0.1870 | 0.2044 | 249   | 60.4  |
| 0010101       | 0.1611                              | 0.1524 | 0.1703 | 249   | 47.5  |
| 0010100       | 0.1268                              | 0.1179 | 0.1363 | 249   | 36.0  |
| 0010011       | 0.0960                              | 0.0900 | 0.1024 | 255   | 27.0  |
| 0010010       | 0.0684                              | 0.0622 | 0.0752 | 255   | 18.7  |

**Table 4. PMBus Address Selection Settings (continued)**

| PMBus ADDRESS | RESISTOR DIVIDER RATIO ( $\Omega$ )                      |        |        | (R <sub>HIGH</sub> ) (k $\Omega$ )<br>HIGH-SIDE<br>RESISTOR | (R <sub>LOW</sub> ) (k $\Omega$ )<br>LOW-SIDE<br>RESISTOR |
|---------------|--|--------|--------|---|---|
|               | (R <sub>LOW</sub> /R <sub>LOW</sub> +R <sub>HIGH</sub> ) | MIN    | MAX    |   |   |
| 0010001       | 0.0404   | 0.0340 | 0.0480 | 270   | 11.5  |
| 0010000       | < 0.013  |        |        | 300   | 1   |

## 7.5.4 Supported Formats

The supported formats are described in this section.

### 7.5.4.1 Direct Format: Write

The simplest format for a PMBus write is direct format. After the START condition [S], the slave chip address is sent, followed by an eighth bit indicating a write. The TPS53915 then acknowledges that it is being addressed, and the master responds with an 8-bit register address byte. The slave acknowledges and the master sends the appropriate 8-bit data byte. Again the slave acknowledges and the master terminates the transfer with the STOP condition [P].

### 7.5.4.2 Combined Format: Read

After the START condition [S], the slave chip address is sent, followed by an eighth bit indicating a write. The TPS53915 then acknowledges that it is being addressed, and the master responds with an 8-bit register address byte. The slave acknowledges and the master sends the repeated START condition [Sr]. Again the slave chip address is sent, followed by an eighth bit indicating a read. The slave responds with an acknowledge followed by previously addressed 8 bit data byte. The master then sends a non-acknowledge (NACK) and finally terminates the transfer with the STOP condition [P].

### 7.5.4.3 Stop-Separated Reads

Stop-separated read features are also available. This format allows a master to initialize the register address pointer for a read and return to that slave at a later time to read the data. In this format the slave chip address followed by a write bit are sent after a START [S] condition. The TPS53915 then acknowledges it is being addressed, and the master responds with the 8-bit register address byte. The master then sends a STOP or RESTART condition and may then address another slave. After performing other tasks, the master can send a START or RESTART condition to the device with a read command. The device acknowledges this request and returns the data from the register location that had been set up previously.

## 7.5.5 Supported PMBus Commands

The TPS53915 supports the PMBus commands shown in [Table 5](#) only. Not all features of each PMBus command are supported. The CLEAR\_FAULTS, STORE\_DEFAULT\_ALL and RESTORE\_DEFAULT\_ALL commands have no data bytes. The non-volatile memory (NVM) cells inside the TPS53915 can permanently store some registers.

**Table 5. Supported PMBus Commands**

| COMMAND                | NOTES  |
|------------------------|--|
| OPERATION              | Turn on or turn off switching converter only                             |
| ON_OFF_CONFIG          | ON/OFF configuration   |
| CLEAR_FAULTS           | Clear all latched status flags   |
| WRITE_PROTECT          | Control writing to the PMBus device                                      |
| STORE_DEFAULT_ALL      | Store contents of user-accessible registers to non-volatile memory cells |
| RESTORE_DEFAULT_ALL    | Copy contents of non-volatile memory cells to user-accessible registers  |
| STATUS_WORD            | PMBus read-only status and flag bits                                     |
| CUSTOM_REG             | MFR_SPECIFIC_00 (Custom Register 0): Custom register                     |
| DELAY_CONTROL          | MFR_SPECIFIC_01 (Custom Register 1): Power on and power good delay times |
| MODE_SOFT_START_CONFIG | MFR_SPECIFIC_02 (Custom Register 2): Mode and soft-start time            |
| FREQUENCY_CONFIG       | MFR_SPECIFIC_03 (Custom Register 3): Switching frequency control         |

**Table 5. Supported PMBus Commands (continued)**

| COMMAND         | NOTES   |
|-----------------|---|
| VOUT_ADJUSTMENT | MFR_SPECIFIC_04 (Custom Register 4): Output voltage adjustment control    |
| VOUT_MARGIN     | MFR_SPECIFIC_05 (Custom Register 5): Output voltage margin levels         |
| UVLO_THRESHOLD  | MFR_SPECIFIC_06 (Custom Register 6): Turn-on input voltage UVLO threshold |

### 7.5.5.1 Unsupported PMBus Commands

Do not send any unsupported commands to the TPS53915. Even though the device receives an unsupported commands, it can acknowledge the unsupported commands and any related data bytes by properly sending the ACK bits. However, the device ignores the unsupported commands and any related data bytes, which means they do not affect the device operation in any way. Although the TPS53915 may acknowledge but ignore unsupported commands and data bytes, it can however, set the CML bit in the STATUS\_BYTE register and then pull down the ALERT pin to notify the host. For this reason, unsupported commands and data bytes should not be sent to TPS53915.

### 7.5.5.2 OPERATION [01h] (R/W Byte)

The TPS53915 supports only the functions of the OPERATION command shown in [Table 6](#).

**Table 6. OPERATION Command Supported Functions**

| COMMAND        | DEFINITION    | DESCRIPTION   | NVM |
|----------------|---------------|---|-----|
| OPERATION<7>   | ON_OFF        | 0: turn off switching converter<br>1: turn on switching converter   | —   |
| OPERATION<6>   | —             | not supported and don't care  | —   |
| OPERATION<5:2> | OPMARGIN<3:0> | 00xx: turn off output voltage margin function<br>0101: turn on output voltage margin low and ignore fault<br>0110: turn on output voltage margin low and act on fault<br>1001: turn on output voltage margin high and ignore fault<br>1010: turn on output voltage margin high and act on fault | —   |
| OPERATION<1>   | —             | not supported and don't care  | —   |
| OPERATION<0>   | —             | not supported and don't care  | —   |

### 7.5.5.3 ON\_OFF\_CONFIG [02h] (R/W Byte)

The TPS53915 supports only the functions of the ON\_OFF\_CONFIG command shown in [Table 7](#).

**Table 7. ON\_OFF\_CONFIG Command Supported Functions**

| COMMAND          | DEFINITION | DESCRIPTION   | NVM |
|------------------|------------|---|-----|
| ON_OFF_CONFIG<7> | —          | not supported and don't care  | —   |
| ON_OFF_CONFIG<6> | —          | not supported and don't care  | —   |
| ON_OFF_CONFIG<5> | —          | not supported and don't care  | —   |
| ON_OFF_CONFIG<4> | PU         | not supported and always set to 1   | —   |
| ON_OFF_CONFIG<3> | CMD        | 0: ignore ON_OFF bit (OPERATION<7>) <sup>(1)</sup><br>1: act on ON_OFF bit (OPERATION<7>) | Yes |
| ON_OFF_CONFIG<2> | CP         | 0: ignore EN pin<br>1: act on EN pin <sup>(1)</sup>                                       | Yes |
| ON_OFF_CONFIG<1> | PL         | not supported and always set to 1   | —   |
| ON_OFF_CONFIG<0> | SP         | not supported and always set to 1   | —   |

(1) TI default

Conditions required to enable the switcher:

- If CMD is cleared and CP is set, then the switcher can be enabled only by the EN pin.
- If CMD is set and CP is cleared, then the switcher can be enabled only by the ON\_OFF bit (OPERATION<7>) via PMBus.
- If both CMD and CP are set, then the switcher can be enabled only when both the ON\_OFF bit

(OPERATION<7>) and the EN pin are commanding to enable the device.

- If both CMD and CP are cleared, then the switcher is automatically enabled after the ADDR detection sequence completes, regardless of EN pin and ON\_OFF bit polarities.

#### 7.5.5.4 WRITE\_PROTECT [10h] (R/W Byte)

The WRITE\_PROTECT command is used to control writing to the PMBus device. The intent of this command is to provide protection against accidental changes. This command has one data byte as described in [Table 8](#).

**Table 8. WRITE\_PROTECT Command Supported Functions**

| COMMAND            | DEFINITION | DESCRIPTION | NVM  |   |
|--------------------|------------|-------------|--|---|
| WRITE_PROTECT<7:0> | WP<7:0>    | 10000000:   | Disable all writes, except the WRITE_PROTECT command.                                | — |
|                    |            | 01000000:   | Disable all writes, except the WRITE_PROTECT and OPERATION commands.                 | — |
|                    |            | 00100000:   | Disable all writes, except the WRITE_PROTECT, OPERATION, and ON_OFF_CONFIG commands. | — |
|                    |            | 00000000:   | Enable writes to all commands.   | — |
|                    |            | Others:     | Fault data   | — |

#### 7.5.6 CLEAR\_FAULTS [03h] (Send Byte)

The CLEAR\_FAULTS command is used to clear any fault bits in the STATUS\_WORD and STATUS\_BYTE registers that have been set. This command clears all bits in all status registers. Simultaneously, the TPS53915 releases its  $\overline{\text{ALERT}}$  signal output if the device is asserting the  $\overline{\text{ALERT}}$  signal. If the FAULT condition is still present when the bit is cleared, the fault bits shall immediately be set again, and the  $\overline{\text{ALERT}}$  signal should also be re-asserted.

The CLEAR\_FAULTS does not cause a unit that has latched off for a FAULT condition to restart. Units that have been shut down for a FAULT condition can be restarted with one of the following conditions.

- The output is commanded through the EN pin and/or ON\_OFF bit based on the ON\_OFF\_CONFIG setting to turn off and then to turn back on.
- VDD power is cycled for TPS53915

The CLEAR\_FAULT command is used to clear the fault bits in the STATUS\_WORD and STATUS\_BYTE commands, and to release the  $\overline{\text{ALERT}}$  pin. It is recommended not to send CLEAR\_FAULT command when there is no fault to cause the  $\overline{\text{ALERT}}$  pin to pull down.

#### 7.5.7 STORE\_DEFAULT\_ALL [11h] (Send Byte)

The STORE\_DEFAULT\_ALL command instructs TPS53915 to copy the entire contents of the operating memory to the corresponding locations in the NVM. The updated contents in the non-volatile memory (NVM)s become the new default values. The STORE\_DEFAULT\_ALL command can be used while the device is operating. However, the device may be unresponsive during the copy operation with unpredictable results. (see *PMBus Power System Management Protocol Specification*, Part II - Command Language, Revision, 1.2, 6 Sept. 2010. [www.powerSIG.org](http://www.powerSIG.org)). It is recommended not to exceed 1000 write/erase cycles for non-volatile memory (NVM).

#### 7.5.8 RESTORE\_DEFAULT\_ALL [12h] (Send Byte)

The RESTORE\_DEFAULT\_ALL command instructs TPS53915 to copy the entire contents of the NVMs to the corresponding locations in the operating memory. The values in the operating memory are overwritten by the value retrieved from the NVM. It is permitted to use the RESTORE\_DEFAULT\_ALL command while the device is operating. However, the device may be unresponsive during the copy operation with unpredictable results.

### 7.5.9 STATUS\_WORD [79h] (Read Word)

The TPS53915 does not support all functions of the STATUS\_WORD command. A list of supported functions appears in [Table 9](#). A status bit reflects the current state of the converter. Status bit becomes high when the specified condition has occurred and goes low when the specified condition has disappeared. A flag bit is a latched bit that becomes high when the specified condition has occurred and does not go back low when the specified condition has disappeared. STATUS\_BYTE command is a subset of the STATUS\_WORD command, or more specifically the lower byte of the STATUS\_WORD.

**Table 9. STATUS\_WORD Command Supported Functions**

| COMMAND                            | DEFINITION                | DESCRIPTION   |
|------------------------------------|---------------------------|---|
| <b>Low Byte: STATUS_BYTE [78h]</b> |                           |   |
| Low STATUS_WORD<7>                 | BUSY                      | not supported and always set to 0   |
| Low STATUS_WORD<6>                 | OFF                       | 0: raw status indicating device is providing power to output voltage<br>1: raw status indicating device is not providing power to output voltage                  |
| Low STATUS_WORD<5>                 | VOUT_OV                   | 0: latched flag indicating no output voltage overvoltage fault has occurred<br>1: latched flag indicating an output voltage overvoltage fault has occurred        |
| Low STATUS_WORD<4>                 | IOUT_OC                   | 0: latched flag indicating no output current overcurrent fault has occurred<br>1: latched flag indicating an output current overcurrent fault has occurred        |
| Low STATUS_WORD<3>                 | VIN_UV                    | 0: latched flag indicating input voltage is above the UVLO turn-on threshold<br>1: latched flag indicating input voltage is below the UVLO turn-on threshold      |
| Low STATUS_WORD<2>                 | TEMP                      | 0: latched flag indicating no OT fault has occurred<br>1: latched flag indicating an OT fault has occurred  |
| Low STATUS_WORD<1>                 | CML                       | 0: latched flag indicating no communication, memory or logic fault has occurred<br>1: latched flag indicating a communication, memory or logic fault has occurred |
| Low STATUS_WORD<0>                 | OTHER                     | not supported and always set to 0   |
| <b>High Byte</b>                   |                           |   |
| High STATUS_WORD<7>                | VOUT                      | 0: latched flag indicating no output voltage fault or warning has occurred<br>1: latched flag indicating a output voltage fault or warning has occurred           |
| High STATUS_WORD<6>                | IOUT                      | 0: latched flag indicating no output current fault or warning has occurred<br>1: latched flag indicating an output current fault or warning has occurred          |
| High STATUS_WORD<5>                | INPUT                     | 0: latched flag indicating no input voltage fault or warning has occurred<br>1: latched flag indicating a input voltage fault or warning has occurred             |
| High STATUS_WORD<4>                | MFR                       | not supported and always set to 0   |
| High STATUS_WORD<3>                | $\overline{\text{PGOOD}}$ | 0: raw status indicating PGOOD pin is at logic high<br>1: raw status indicating PGOOD pin is at logic low   |
| High STATUS_WORD<2>                | FANS                      | not supported and always set to 0   |
| High STATUS_WORD<1>                | OTHER                     | not supported and always set to 0   |
| High STATUS_WORD<0>                | UNKNOWN                   | not supported and always set to 0   |

The latched flags of faults can be removed or corrected only until **one** of the following conditions occurs:

- The device receives a CLEAR\_FAULTS command.
- The output is commanded through the EN pin and/or ON\_OFF bit based on the ON\_OFF\_CONFIG setting to turn off and then to turn back on
- VDD power is cycled for TPS53915

If the FAULT condition remains present when the bit is cleared, the fault bits are immediately set again, and the ALERT signal is re-asserted.

TPS53915 supports the  $\overline{\text{ALERT}}$  pin to notify the host of FAULT conditions. Therefore, the best practice for monitoring the fault conditions from the host is to treat the  $\overline{\text{ALERT}}$  pin as an interrupt source for triggering the corresponding interrupt service routine. It is recommended not to keep polling the STATUS\_WORD or STATUS\_BYTE registers from the host to reduce the firmware overhead of the host.

### 7.5.10 CUSTOM\_REG (MFR\_SPECIFIC\_00) [D0h] (R/W Byte)

Custom register 0 provides the flexibility for users to store any desired non-volatile information. For example, users can program this register to track versions of implementation or other soft identification information. The details of each setting are listed in [Table 10](#).

**Table 10. CUSTOM\_REG (MFR\_SPECIFIC\_00) Settings**

| COMMAND         | DEFINITION       | DESCRIPTION  | NVM |
|-----------------|------------------|--|-----|
| CUSTOM_REG<7>   | —                | not supported and don't care   | —   |
| CUSTOM_REG<6>   | —                | not supported and don't care   | —   |
| CUSTOM_REG<5:0> | CUSTOMWORD <5:0> | 00000: <sup>(1)</sup> can be used to store any desired non-volatile information. | Yes |

(1) TI Default

### 7.5.11 DELAY\_CONTROL (MFR\_SPECIFIC\_01) [D1h] (R/W Byte)

Custom register 1 provides software control over key timing parameters of the controller: Power-on delay (POD) time and power-good delay (PGD) time. The details of each setting are listed in [Table 11](#).

**Table 11. DELAY\_CONTROL (MFR\_SPECIFIC\_01) Settings**

| COMMAND            | DEFINITION | DESCRIPTION  | NVM |
|--------------------|------------|--|-----|
| DELAY_CONTROL<7>   | —          | not supported and don't care   | —   |
| DELAY_CONTROL<6>   | —          | not supported and don't care   | —   |
| DELAY_CONTROL<5:3> | PGD<2:0>   | 000: 256 $\mu$ s<br>001: 512 $\mu$ s<br>010: 1.024 ms <sup>(1)</sup><br>011: 2.048 ms<br>100: 4.096 ms<br>101: 8.192 ms<br>110: 16.384 ms<br>111: 131.072 ms | Yes |
| DELAY_CONTROL<2:0> | POD<2:0>   | 000: 356 $\mu$ s<br>001: 612 $\mu$ s<br>010: 1.124 ms <sup>(1)</sup><br>011: 2.148 ms<br>100: 4.196 ms<br>101: 8.292 ms<br>110: 16.484 ms<br>111: 32.868 ms  | Yes |

(1) TI Default

### 7.5.12 MODE\_SOFT\_START\_CONFIG (MFR\_SPECIFIC\_02) [D2h] (R/W Byte)

Custom register 2 provides software control over mode selection and soft-start time ( $t_{SS}$ ). The details of each setting are listed in [Table 12](#).

**Table 12. MODE\_SOFT\_START\_CONFIG (MFR\_SPECIFIC\_02) Settings**

| COMMAND                     | DEFINITION | DESCRIPTION   | NVM |
|-----------------------------|------------|---|-----|
| MODE_SOFT_START_CONFIG<7>   | —          | not supported and don't care                                | —   |
| MODE_SOFT_START_CONFIG<6>   | —          | not supported and don't care                                | —   |
| MODE_SOFT_START_CONFIG<5>   | —          | not supported and don't care                                | —   |
| MODE_SOFT_START_CONFIG<4>   | —          | not supported and don't care                                | —   |
| MODE_SOFT_START_CONFIG<3:2> | SST<1:0>   | 00: 1 ms <sup>(1)</sup><br>01: 2 ms<br>10: 4 ms<br>11: 8 ms | Yes |

(1) TI Default



**Table 12. MODE\_SOFT\_START\_CONFIG (MFR\_SPECIFIC\_02) Settings (continued)**

| COMMAND                   | DEFINITION | DESCRIPTION  | NVM |
|---------------------------|------------|--|-----|
| MODE_SOFT_START_CONFIG<1> | HICLOFF    | 0: hiccup after UV <sup>(1)</sup><br>Hiccup interval is (8.96 ms + soft-start time × 7)<br>1: latch-off after UV | Yes |
| MODE_SOFT_START_CONFIG<0> | CM         | 0: DCM <sup>(1)</sup><br>1: FCCM   | Yes |

Figure 48 shows the soft-start timing diagram of TPS53915 with the programmable power-on delay time ( $t_{POD}$ ), soft-start time ( $t_{SST}$ ), and PGOOD delay time ( $t_{PGD}$ ). During the soft-start time, the controller remains in discontinuous conduction mode (DCM), and then switches to forced continuous conduction mode (FCCM) at the end of soft-start if CM bit (MODE\_SOFT\_START\_CONFIG<0>) is set.

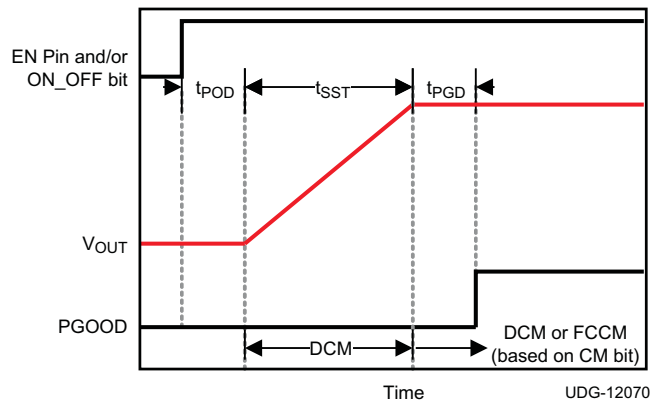

**Figure 48. Programmable Soft-Start Timing**

### 7.5.13 FREQUENCY\_CONFIG (MFR\_SPECIFIC\_03) [D3h] (R/W Byte)

Custom register 3 provides software control over frequency setting (FS). The details of FS setting are listed in Table 13.

**Table 13. FREQUENCY\_CONFIG (MFR\_SPECIFIC\_03) Settings**

| COMMAND               | DEFINITION | DESCRIPTION   | NVM |
|-----------------------|------------|---|-----|
| FREQUENCY_CONFIG<7>   | —          | not supported and don't care  | —   |
| FREQUENCY_CONFIG<6>   | —          | not supported and don't care  | —   |
| FREQUENCY_CONFIG<5>   | —          | not supported and don't care  | —   |
| FREQUENCY_CONFIG<4>   | —          | not supported and don't care  | —   |
| FREQUENCY_CONFIG<3>   | —          | not supported and don't care  | —   |
| FREQUENCY_CONFIG<2:0> | FS<2:0>    | 000: 250 kHz<br>001: 300 kHz<br>010: 400 kHz <sup>(1)</sup><br>011: 500 kHz<br>100: 600 kHz<br>101: 750 kHz<br>110: 850 kHz<br>111: 1 MHz | Yes |

(1) TI default.

### 7.5.14 VOUT\_ADJUSTMENT (MFR\_SPECIFIC\_04) [D4h] (R/W Byte)

Custom register 4 provides output voltage adjustment (VOA) in ±0.75% steps, with a total range of ±9%. When fine adjustment is used together with the margin setting, the change in the output voltage is determined by the multiplication of the two settings.



**Table 14. VOUT\_ADJUSTMENT (MFR\_SPECIFIC\_04) Settings**

| COMMAND              | DEFINITION | DESCRIPTION   | NVM |
|----------------------|------------|---|-----|
| VOUT_ADJUSTMENT<7>   | —          | not supported and don't care  | —   |
| VOUT_ADJUSTMENT<6>   | —          | not supported and don't care  | —   |
| VOUT_ADJUSTMENT<5>   | —          | not supported and don't care  | —   |
| VOUT_ADJUSTMENT<4:0> | VOA<4:0>   | 111xx: +9.00%<br>11011: +8.25%<br>11010: +7.50%<br>11001: +6.75%<br>11000: +6.00%<br>10111: +5.25%<br>10110: +4.50%<br>10101: +3.75%<br>10100: +3.00%<br>10011: +2.25%<br>10010: +1.50%<br>10001: +0.75%<br>10000: +0% <sup>(1)</sup><br>01111: –0%<br>01110: –0.75%<br>01101: –1.50%<br>01100: –2.25%<br>01011: –3.00%<br>01010: –3.75%<br>01001: –4.50%<br>01000: –5.25%<br>00111: –6.00%<br>00110: –6.75%<br>00101: –7.50%<br>00100: –8.25%<br>000xx: –9.00% | Yes |

(1) TI default.

### 7.5.15 Output Voltage Fine Adjustment Soft Slew Rate

To prevent sudden buildup of voltage across inductor, output voltage fine adjustment setting cannot change output voltage instantaneously. The internal reference voltage must slew slowly to its final target, and SST<1:0> is used to provide further programmability. The details of output voltage fine adjustment slew rate are shown in [Table 15](#).

**Table 15. Output Voltage Fine Adjustment Soft Slew Rate Settings**

| COMMAND                     | DEFINITION | DESCRIPTION   | NVM |
|-----------------------------|------------|---|-----|
| MODE_SOFT_START_CONFIG<3:2> | SST<1:0>   | 00: 1 step per 4 $\mu$ s <sup>(1)</sup><br>01: 1 step per 8 $\mu$ s<br>10: 1 step per 16 $\mu$ s<br>11: 1 step per 32 $\mu$ s | Yes |

(1) TI default.

### 7.5.16 VOUT\_MARGIN (MFR\_SPECIFIC\_05) [D5h] (R/W Byte)

Custom register 5 provides output voltage margin high (VOMH) and output voltage margin low (VOML) settings. This register works in conjunction with PMBus OPERATION command to raise or lower the output voltage by a specified amount. This register settings described in [Table 16](#) are also used together with the fine adjustment setting described in [Table 14](#). For example, setting fine adjustment to +9% and margin to +12% changes the output by +22.08%, whereas setting fine adjustment to –9% and margin to –9% change the output by –17.19%

**Table 16. VOUT\_MARGIN (MFR\_SPECIFIC\_05) Settings**

| COMMAND          | DEFINITION | DESCRIPTION  | NVM |
|------------------|------------|--|-----|
| VOUT_MARGIN<7:4> | VOMH<3:0>  | 11xx: +12.0%<br>1011: +10.9%<br>1010: +9.9%<br>1001: +8.8%<br>1000: +7.7%<br>0111: +6.7%<br>0110: +5.7%<br>0101: +4.7% <sup>(1)</sup><br>0100: +3.7%<br>0011: +2.8%<br>0010: +1.8%<br>0001: +0.9%<br>0000: +0% | Yes |
| VOUT_MARGIN<3:0> | VOML<3:0>  | 0000: -0%<br>0001: -1.1%<br>0010: -2.1%<br>0011: -3.2%<br>0100: -4.2%<br>0101: -5.2% <sup>(1)</sup><br>0110: -6.2%<br>0111: -7.1%<br>1000: -8.1%<br>1001: -9.0%<br>1010: -9.9%<br>1011: -10.7%<br>11xx: -11.6% | Yes |

(1) TI default.

### 7.5.17 Output Voltage Margin Adjustment Soft-Slew Rate

Similar to the output voltage fine adjustment, margin adjustment also cannot change output voltage instantaneously. The soft-slew rate of margin adjustment is also programmed by SST<1:0>. The details are listed in [Table 17](#).

**Table 17. Output Voltage Margin Adjustment Soft-Slew Rate Settings**

| COMMAND                     | DEFINITION | DESCRIPTION   | NVM |
|-----------------------------|------------|---|-----|
| MODE_SOFT_START_CONFIG<3:2> | SST<1:0>   | 00: 1 step per 4 $\mu$ s <sup>(1)</sup><br>01: 1 step per 8 $\mu$ s<br>10: 1 step per 16 $\mu$ s<br>11: 1 step per 32 $\mu$ s | Yes |

(1) TI default.

Figure 49 shows the timing diagram of the output voltage adjustment via PMBus. After receiving the write command of VOUT\_ADJUSTMENT (MFR\_SPECIFIC\_04), the output voltage starts to be adjusted after  $t_p$  delay time (about 50  $\mu$ s). The time duration  $t_{DAC}$  for each DAC step change can be controlled by SST bits (MODE\_SOFT\_START\_CONFIG<3:2> from 4  $\mu$ s to 32  $\mu$ s).

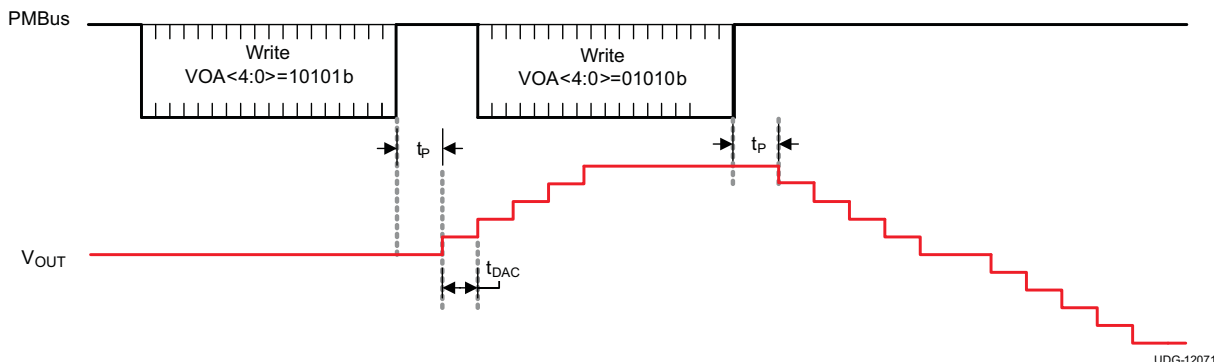

Figure 49. Output Voltage Adjustment via PMBus

The margining function is enabled by setting the OPERATION command, and the margining level is determined by the VOUT\_MARGIN (MFR\_SPECIFIC\_05) command. Figure 50 and Figure 51 illustrate the timing diagrams of the output voltage margining via PMBus. Figure 50 shows setting the margining level first, and then enabling margining by writing OPERATION command. After the OPERATION margin high command enables the margin high setting (VOMH<3:0>), the output voltage starts to be adjusted after  $t_p$  delay time (about 50  $\mu$ s). The time duration  $t_{DAC}$  for each DAC step change can be controlled by SST bits (MODE\_SOFT\_START\_CONFIG<3:2>) from 4  $\mu$ s to 32  $\mu$ s.

As shown in Figure 51, the margining function is enabled first by a write command of OPERATION. The output voltage starts to be adjusted toward the default margin high level after  $t_p$  delay. Because the margining function has been enabled, the output voltage can be adjusted again by sending a different margin high level with a write command of VOUT\_MARGIN. The time duration  $t_{DAC}$  for each DAC step change can be also controlled by SST bits (MODE\_SOFT\_START\_CONFIG<3:2>) from 4  $\mu$ s to 32  $\mu$ s.

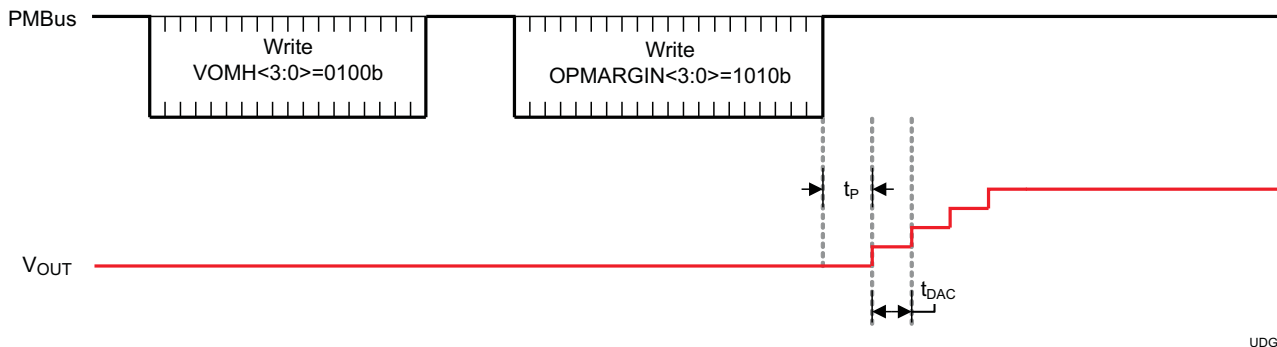
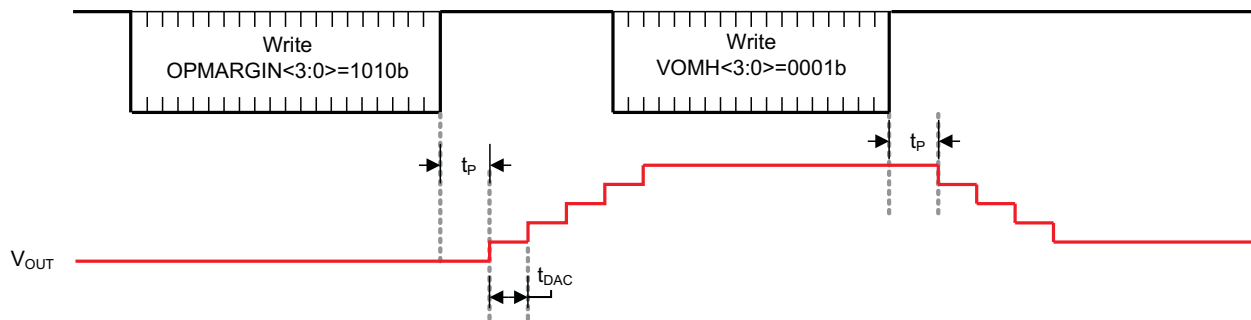

Figure 50. Setting the Margining Level First



UDG-12073

**Figure 51. Enabling Margining First**

### 7.5.18 UVLO\_THRESHOLD (MFR\_SPECIFIC\_06) [D6h]

Custom register 6 provides some limited programmability of input supply UVLO threshold, as described in [Table 18](#). The default turn-on UVLO threshold is 4.25 V.

**Table 18. UVLO\_THRESHOLD (MFR\_SPECIFIC\_06) Settings**

| COMMAND             | DEFINITION     | DESCRIPTION  | NVM |
|---------------------|----------------|--|-----|
| UVLO_THRESHOLD<7>   | —              | not supported and don't care   | —   |
| UVLO_THRESHOLD<6>   | —              | not supported and don't care   | —   |
| UVLO_THRESHOLD<5>   | —              | not supported and don't care   | —   |
| UVLO_THRESHOLD<4>   | —              | not supported and don't care   | —   |
| UVLO_THRESHOLD<3>   | —              | not supported and don't care   | —   |
| UVLO_THRESHOLD<2:0> | VDDINUVLO<2:0> | 0xx: 10.2 V<br>100: not supported and should not be used<br>101: 4.25 V <sup>(1)</sup><br>110: 6.0 V<br>111: 8.1 V | Yes |

(1) TI default.

## 8 Application and Implementation

### NOTE

Information in the following applications sections is not part of the TI component specification, and TI does not warrant its accuracy or completeness. TI's customers are responsible for determining suitability of components for their purposes. Customers should validate and test their design implementation to confirm system functionality.

### 8.1 Application Information

The TPS53915 device is a high-efficiency, single-channel, synchronous-buck converter. The device suits low-output voltage point-of-load applications with 12-A or lower output current in computing and similar digital consumer applications.

### 8.2 Typical Application

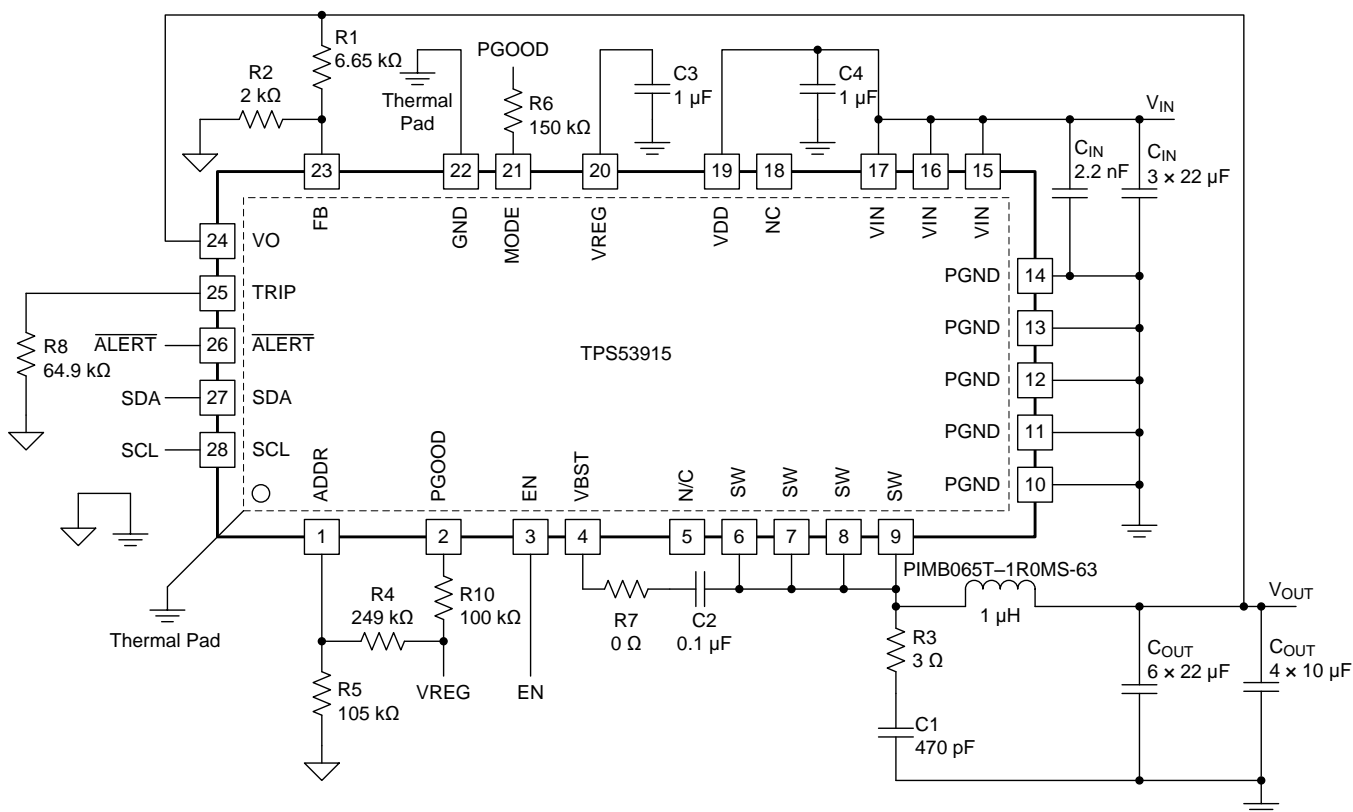

Figure 52. Typical Application Circuit Diagram

## Typical Application (continued)

### 8.2.1 Design Requirements

This design uses the parameters listed in [Table 19](#).

**Table 19. Design Example Specifications**

| PARAMETER              |                           | TEST CONDITIONS  | MIN | TYP   | MAX | UNIT     |
|------------------------|---------------------------|--|-----|-------|-----|----------|
| INPUT CHARACTERISTICS  |                           |  |     |       |     |          |
| V <sub>IN</sub>        | Voltage range             |  | 5   | 12    | 18  | V        |
| I <sub>MAX</sub>       | Maximum input current     | V <sub>IN</sub> = 5 V, I <sub>OUT</sub> = 8 A  |     | 2.5   |     | A        |
|                        | No load input current     | V <sub>IN</sub> = 12 V, I <sub>OUT</sub> = 0 A with auto skip mode                   |     | 1     |     | mA       |
| OUTPUT CHARACTERISTICS |                           |  |     |       |     |          |
| V <sub>OUT</sub>       | Output voltage            |  |     | 1.2   |     | V        |
|                        | Output voltage regulation | Line regulation, 0.2% 5 V ≤ V <sub>IN</sub> ≤ 14 V with FCCM                         |     | 0.2%  |     |          |
|                        |                           | Load regulation, 0.5% V <sub>IN</sub> = 12 V, 0 A ≤ I <sub>OUT</sub> ≤ 8 A with FCCM |     | 0.5%  |     |          |
| V <sub>RIPPLE</sub>    | Output voltage ripple     | V <sub>IN</sub> = 12 V, I <sub>OUT</sub> = 8 A with FCCM                             |     | 10    |     | mV<br>PP |
| I <sub>LOAD</sub>      | Output load current       |  | 0   |       | 8   | A        |
| I <sub>OVER</sub>      | Output over current       |  |     | 11    |     |          |
| t <sub>SS</sub>        | Soft-start time           |  |     | 1     |     | ms       |
| SYSTEM CHARACTERISTICS |                           |  |     |       |     |          |
| f <sub>SW</sub>        | Switching frequency       |  |     | 500   |     | kHz      |
| η                      | Peak efficiency           | V <sub>IN</sub> = 12 V, V <sub>OUT</sub> = 1.2 V, I <sub>OUT</sub> = 4 A             |     | 88.5% |     |          |
|                        | Full load efficiency      | V <sub>IN</sub> = 12 V, V <sub>OUT</sub> = 1.2 V, I <sub>OUT</sub> = 8 A             |     | 88.9% |     |          |
| T <sub>A</sub>         | Operating temperature     |  |     | 25    |     | °C       |

### 8.2.2 Detailed Design Procedure

The external components selection is a simple process using D-CAP3 Mode. Select the external components using the following steps.

#### 8.2.2.1 Choose the Switching Frequency

The default switching frequency (f<sub>SW</sub>) is pre-set at 400 kHz. The switching frequency can be changed through PMBus function MFR\_SPECIFIC\_03 (see [Table 13](#)).

#### 8.2.2.2 Choose the Operation Mode

Select the operation mode using [Table 3](#).

#### 8.2.2.3 Choose the Inductor

Determine the inductance value to set the ripple current at approximately ¼ to ½ of the maximum output current. Larger ripple current increases output ripple voltage, improves signal-to-noise ratio, and helps to stabilize operation.

$$\begin{aligned}
 L &= \frac{1}{I_{\text{IND(ripple)}} \times f_{\text{SW}}} \times \frac{(V_{\text{IN(max)}} - V_{\text{OUT}}) \times V_{\text{OUT}}}{V_{\text{IN(max)}}} = \frac{3}{I_{\text{OUT(max)}} \times f_{\text{SW}}} \times \frac{(V_{\text{IN(max)}} - V_{\text{OUT}}) \times V_{\text{OUT}}}{V_{\text{IN(max)}}} \\
 &= \frac{3}{6 \times 500 \text{ kHz}} \times \frac{(12 \text{ V} - 1.2 \text{ V}) \times 1.2 \text{ V}}{12 \text{ V}} = 1.08 \mu\text{H}
 \end{aligned} \tag{6}$$

The inductor requires a low DCR to achieve good efficiency. The inductor also requires enough room above peak inductor current before saturation. The peak inductor current is estimated using [Equation 7](#).

$$I_{IND(peak)} = \frac{V_{TRIP}}{8 \times R_{DS(on)}} + \frac{1}{L \times f_{SW}} \times \frac{(V_{IN(max)} - V_{OUT}) \times V_{OUT}}{V_{IN(max)}} = \frac{10 \mu A \times R_{TRIP}}{8 \times 5.9 m\Omega} + \frac{1}{1 \mu H \times 500 kHz} \times \frac{(12 V - 1.2 V) \times 1.2 V}{12 V} \quad (7)$$

### 8.2.2.4 Choose the Output Capacitor

The output capacitor selection is determined by output ripple and transient requirement. When operating in CCM, the output ripple has two components as shown in Equation 8. Equation 9 and Equation 10 define these components.

$$V_{RIPPLE} = V_{RIPPLE(C)} + V_{RIPPLE(ESR)} \quad (8)$$

$$V_{RIPPLE(C)} = \frac{I_{L(ripple)}}{8 \times C_{OUT} \times f_{SW}} \quad (9)$$

$$V_{RIPPLE(ESR)} = I_{L(ripple)} \times ESR \quad (10)$$

### 8.2.2.5 Determine the Value of R1 and R2

The output voltage is programmed by the voltage-divider resistors, R1 and R2, shown in Equation 11. Connect R1 between the VFB pin and the output, and connect R2 between the VFB pin and GND. The recommended R2 value is from 1 kΩ to 20 kΩ. Determine R1 using Equation 11.

$$R1 = \frac{V_{OUT} - 0.6}{0.6} \times R2 = \frac{1.2 V - 0.6}{0.6} \times 10 k\Omega = 10 k\Omega \quad (11)$$

## 8.2.3 Application Curves

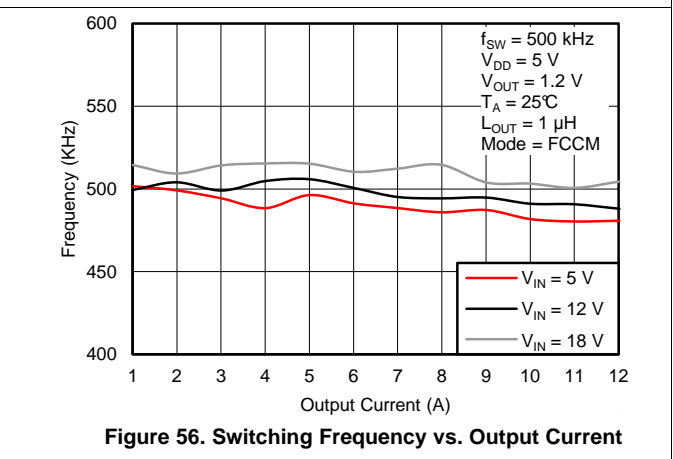
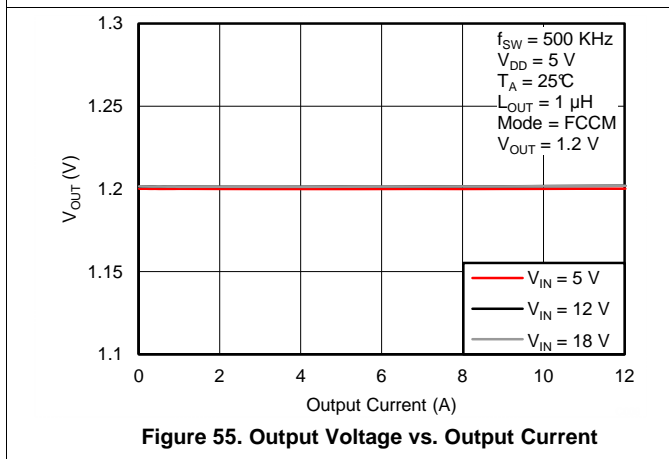
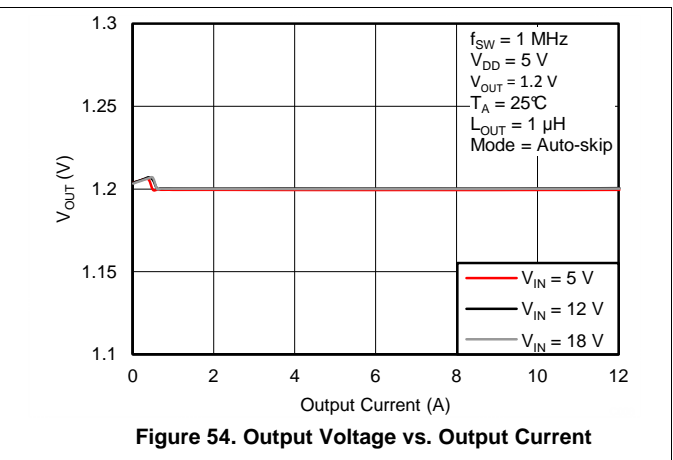
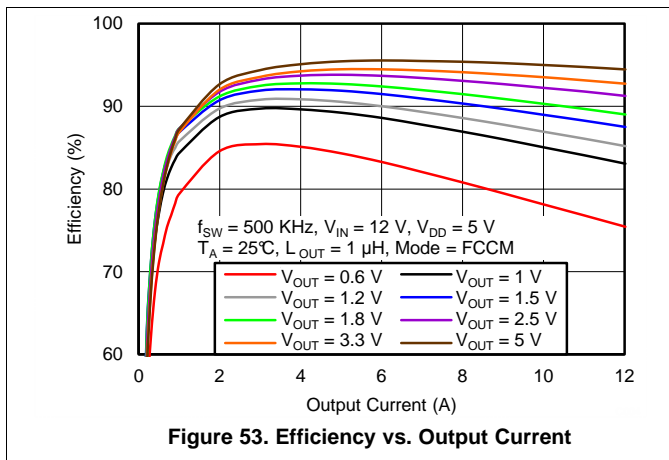



$I_{LOAD} = 6\text{ A}$

Figure 57. Start-Up Sequence

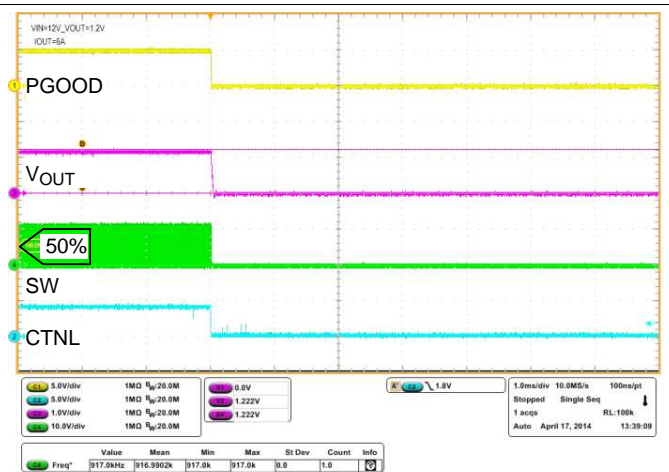

$I_{LOAD} = 6\text{ A}$

Figure 58. Shutdown Sequence

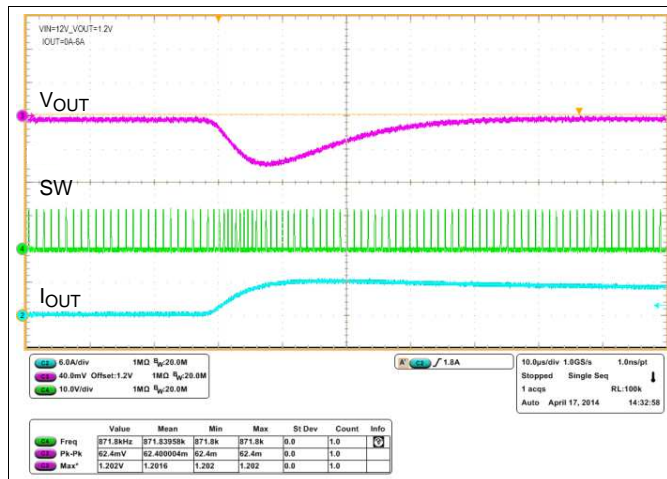

$I_{LOAD}$  from 0 A to 6 A

Figure 59. Load Transient

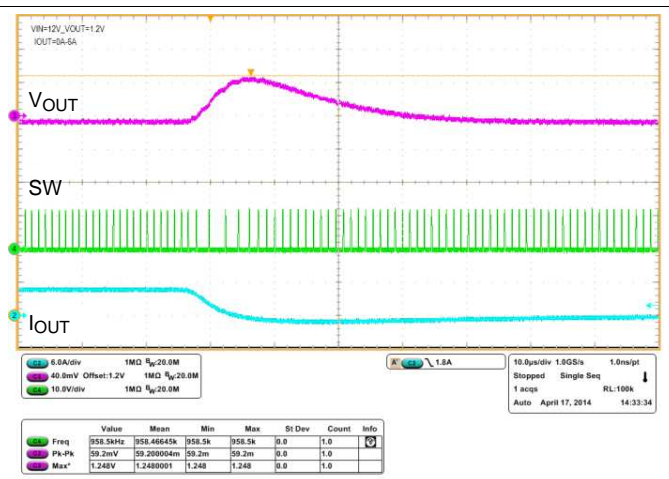

$I_{LOAD}$  from 6 A to 0 A

Figure 60. Load Transient

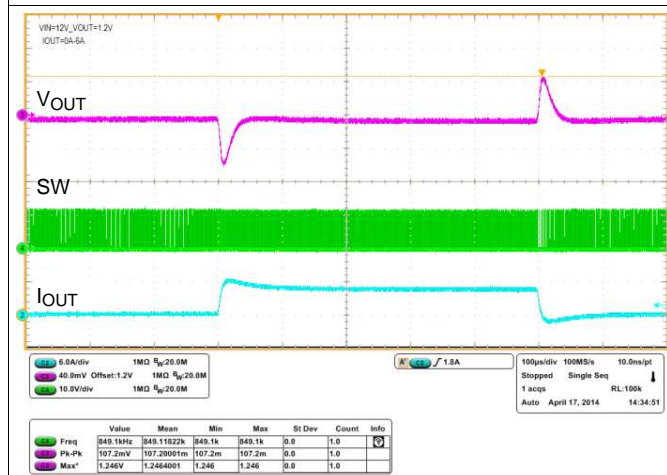

$I_{LOAD}$  from 0 A to 6 A to 0 A

Figure 61. Full Cycle Load Transient

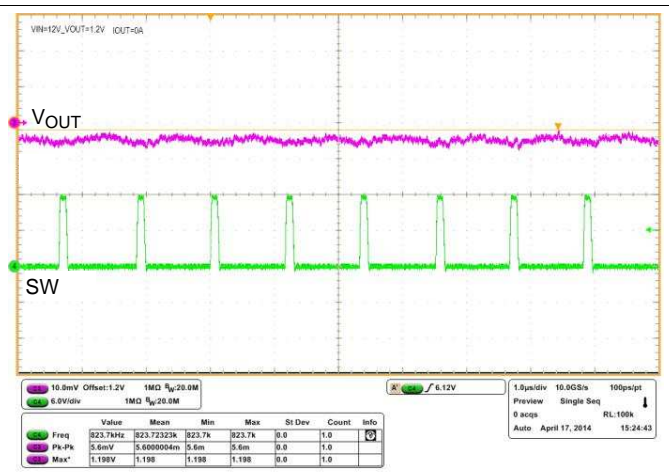

$I_{LOAD} = 0\text{ A}$

Figure 62. Output Voltage Ripple



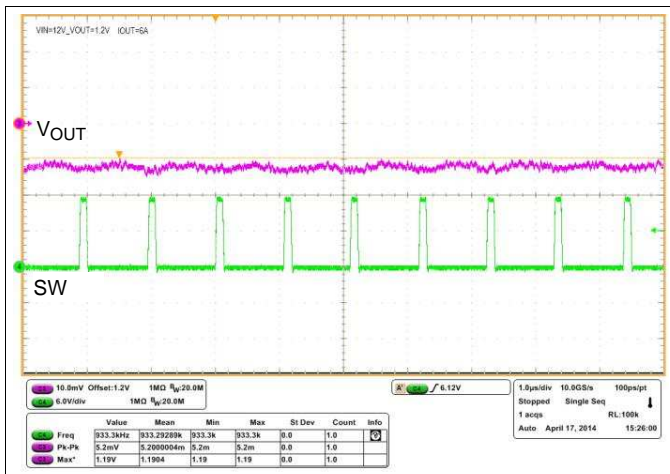

$I_{LOAD} = 6 A$

Figure 63. Output Voltage Ripple

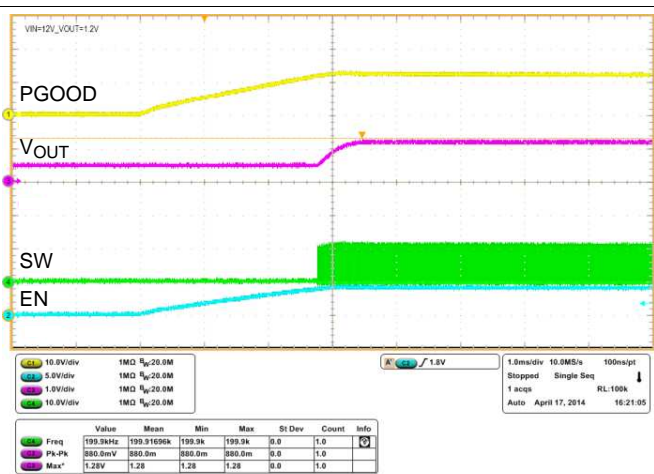

Preset  $V_{OUT} = 0.5 V$

Figure 64. Pre-Bias Start-Up

## 9 Power Supply Recommendations

This device is designed to operate from an input voltage supply between 1.5-V and 18-V (4.5-V and 25-V biased) Input. Use only a well regulated supply. These devices are not designed for split-rail operation. The VIN and VDD terminals must be the same potential for accurate high-side short circuit protection. Proper bypassing of input supplies and internal regulators is also critical for noise performance, as is PCB layout and grounding scheme. See the recommendations in the [Layout](#) section.

## 10 Layout

### 10.1 Layout Guidelines

Before beginning a design using the TPS53915, consider the following:

- Place the power components (including input and output capacitors, the inductor, and the TPS53915) on the solder side of the PCB. In order to shield and isolate the small signal traces from noisy power lines, insert and connect at least one inner plane to ground.
- All sensitive analog traces and components such as VFB, PGOOD, TRIP, MODE, and ADDR must be placed away from high-voltage switching nodes such as SW and VBST to avoid coupling. Use internal layers as ground planes and shield the feedback trace from power traces and components.
- Pin 22 (GND pin) must be connected directly to the thermal pad. Connect the thermal pad to the PGND pins and then to the GND plane.
- Place the VIN decoupling capacitors as close to the VIN and PGND pins as possible to minimize the input AC-current loop.
- Place the feedback resistor near the IC to minimize the VFB trace distance.
- Place the frequency-setting resistor (ADDR), OCP-setting resistor ( $R_{TRIP}$ ) and mode-setting resistor ( $R_{MODE}$ ) close to the device. Use the common GND via to connect the resistors to the GND plane if applicable.
- Place the VDD and VREG decoupling capacitors as close to the device as possible. Provide GND vias for each decoupling capacitor and ensure the loop is as small as possible.
- The PCB trace is defined as switch node, which connects the SW pins and high-voltage side of the inductor. The switch node should be as short and wide as possible.
- Use separated vias or trace to connect SW node to the snubber, bootstrap capacitor, and ripple-injection resistor. Do not combine these connections.
- Place one more small capacitor (2.2 nF- 0402 size) between the VIN and PGND pins. This capacitor must be placed as close to the IC as possible.
- TI recommends placing a snubber between the SW shape and GND shape for effective ringing reduction. The value of snubber design starts at  $3\ \Omega + 470\ \text{pF}$ .
- Consider R,C,Cc network (Ripple injection network) component placement and place the AC coupling capacitor, Cc, close to the device, and R and C close to the power stage.
- See [Figure 65](#) for the layout recommendation.

## 10.2 Layout Example

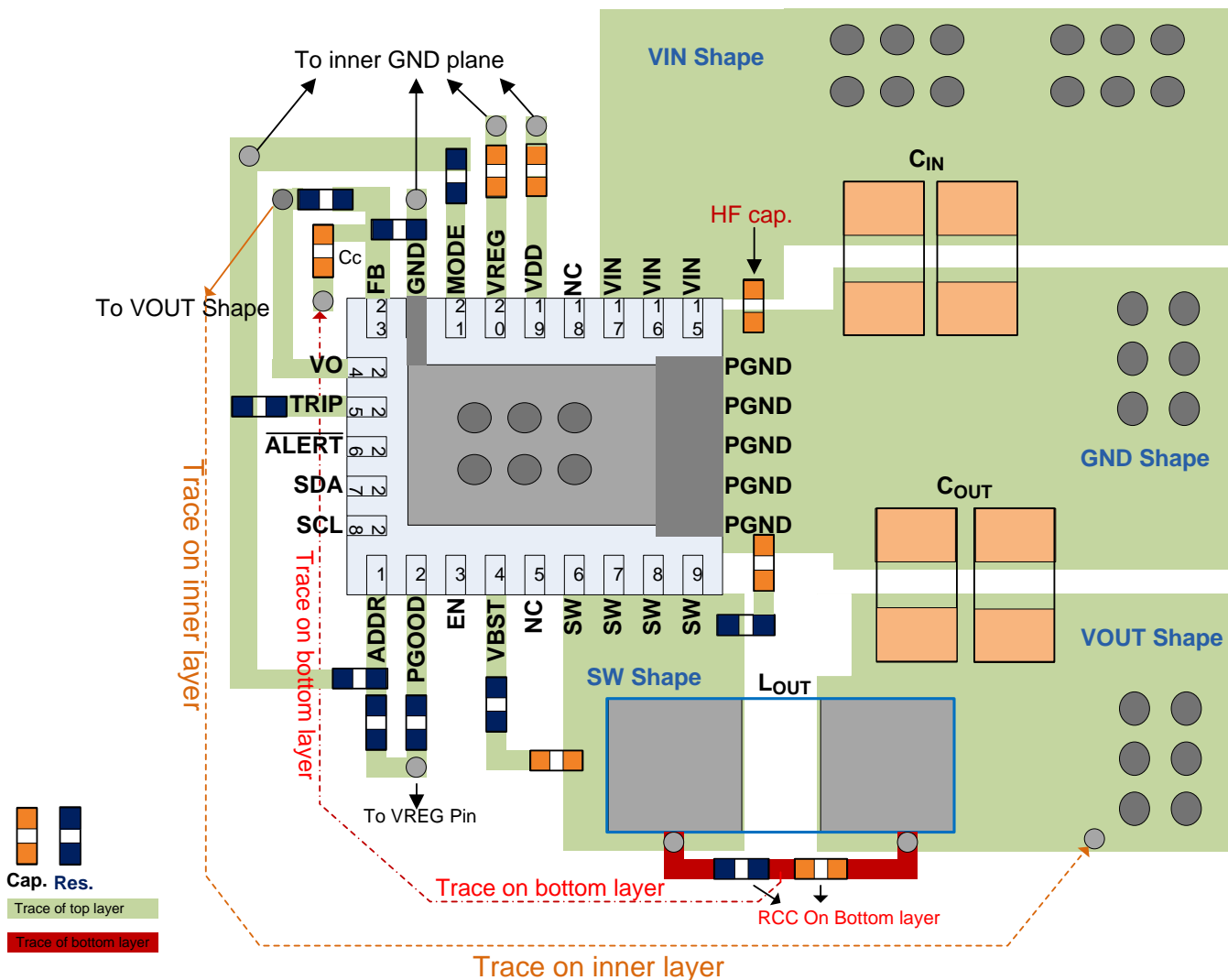

## 11 Device and Documentation Support

### 11.1 Documentation Support

For related documentation, see the following:

- *Optimizing Transient Response of Internally Compensated dc-dc Converters With Feedforward Capacitor*, Application Report [SLVA289](#)

### 11.2 Trademarks

SWIFT, D-CAP3, Eco-Mode, WEBENCH are trademarks of Texas Instruments.

PMBus is a trademark of SMIF, Inc.

All other trademarks are the property of their respective owners.

### 11.3 Electrostatic Discharge Caution



These devices have limited built-in ESD protection. The leads should be shorted together or the device placed in conductive foam during storage or handling to prevent electrostatic damage to the MOS gates.

### 11.4 Glossary



[SLYZ022](#) — *TI Glossary*.

This glossary lists and explains terms, acronyms, and definitions.

## 12 Mechanical, Packaging, and Orderable Information

The following pages include mechanical, packaging, and orderable information. This information is the most current data available for the designated devices. This data is subject to change without notice and revision of this document. For browser-based versions of this data sheet, refer to the left-hand navigation.

**PACKAGING INFORMATION**

| Orderable Device | Status<br>(1) | Package Type | Package Drawing | Pins | Package Qty | Eco Plan<br>(2)     | Lead finish/<br>Ball material<br>(6) | MSL Peak Temp<br>(3) | Op Temp (°C) | Device Marking<br>(4/5) | Samples   |
|------------------|---------------|--------------|-----------------|------|-------------|---------------------|--------------------------------------|----------------------|--------------|-------------------------|---|
| TPS53915RVER     | ACTIVE        | VQFN-CLIP    | RVE             | 28   | 3000        | RoHS-Exempt & Green | NIPDAU   SN                          | Level-2-260C-1 YEAR  | -40 to 85    | TPS53915                |  |
| TPS53915RVET     | ACTIVE        | VQFN-CLIP    | RVE             | 28   | 250         | RoHS-Exempt & Green | NIPDAU   SN                          | Level-2-260C-1 YEAR  | -40 to 85    | TPS53915                |  |

(1) The marketing status values are defined as follows:

**ACTIVE:** Product device recommended for new designs.

**LIFEBUY:** TI has announced that the device will be discontinued, and a lifetime-buy period is in effect.

**NRND:** Not recommended for new designs. Device is in production to support existing customers, but TI does not recommend using this part in a new design.

**PREVIEW:** Device has been announced but is not in production. Samples may or may not be available.

**OBSOLETE:** TI has discontinued the production of the device.

(2) **RoHS:** TI defines "RoHS" to mean semiconductor products that are compliant with the current EU RoHS requirements for all 10 RoHS substances, including the requirement that RoHS substance do not exceed 0.1% by weight in homogeneous materials. Where designed to be soldered at high temperatures, "RoHS" products are suitable for use in specified lead-free processes. TI may reference these types of products as "Pb-Free".

**RoHS Exempt:** TI defines "RoHS Exempt" to mean products that contain lead but are compliant with EU RoHS pursuant to a specific EU RoHS exemption.

**Green:** TI defines "Green" to mean the content of Chlorine (Cl) and Bromine (Br) based flame retardants meet JS709B low halogen requirements of <=1000ppm threshold. Antimony trioxide based flame retardants must also meet the <=1000ppm threshold requirement.

(3) MSL, Peak Temp. - The Moisture Sensitivity Level rating according to the JEDEC industry standard classifications, and peak solder temperature.

(4) There may be additional marking, which relates to the logo, the lot trace code information, or the environmental category on the device.

(5) Multiple Device Markings will be inside parentheses. Only one Device Marking contained in parentheses and separated by a "~" will appear on a device. If a line is indented then it is a continuation of the previous line and the two combined represent the entire Device Marking for that device.

(6) Lead finish/Ball material - Orderable Devices may have multiple material finish options. Finish options are separated by a vertical ruled line. Lead finish/Ball material values may wrap to two lines if the finish value exceeds the maximum column width.

**Important Information and Disclaimer:**The information provided on this page represents TI's knowledge and belief as of the date that it is provided. TI bases its knowledge and belief on information provided by third parties, and makes no representation or warranty as to the accuracy of such information. Efforts are underway to better integrate information from third parties. TI has taken and continues to take reasonable steps to provide representative and accurate information but may not have conducted destructive testing or chemical analysis on incoming materials and chemicals. TI and TI suppliers consider certain information to be proprietary, and thus CAS numbers and other limited information may not be available for release.

In no event shall TI's liability arising out of such information exceed the total purchase price of the TI part(s) at issue in this document sold by TI to Customer on an annual basis.



**TAPE AND REEL INFORMATION**

**QUADRANT ASSIGNMENTS FOR PIN 1 ORIENTATION IN TAPE**

\*All dimensions are nominal

| Device       | Package Type | Package Drawing | Pins | SPQ  | Reel Diameter (mm) | Reel Width W1 (mm) | A0 (mm) | B0 (mm) | K0 (mm) | P1 (mm) | W (mm) | Pin1 Quadrant |
|--------------|--------------|-----------------|------|------|--------------------|--------------------|---------|---------|---------|---------|--------|---------------|
| TPS53915RVER | VQFN-CLIP    | RVE             | 28   | 3000 | 330.0              | 12.4               | 3.8     | 4.8     | 1.18    | 8.0     | 12.0   | Q1            |
| TPS53915RVET | VQFN-CLIP    | RVE             | 28   | 250  | 180.0              | 12.4               | 3.8     | 4.8     | 1.18    | 8.0     | 12.0   | Q1            |

**TAPE AND REEL BOX DIMENSIONS**

\*All dimensions are nominal

| Device       | Package Type | Package Drawing | Pins | SPQ  | Length (mm) | Width (mm) | Height (mm) |
|--------------|--------------|-----------------|------|------|-------------|------------|-------------|
| TPS53915RVER | VQFN-CLIP    | RVE             | 28   | 3000 | 367.0       | 367.0      | 38.0        |
| TPS53915RVET | VQFN-CLIP    | RVE             | 28   | 250  | 213.0       | 191.0      | 35.0        |



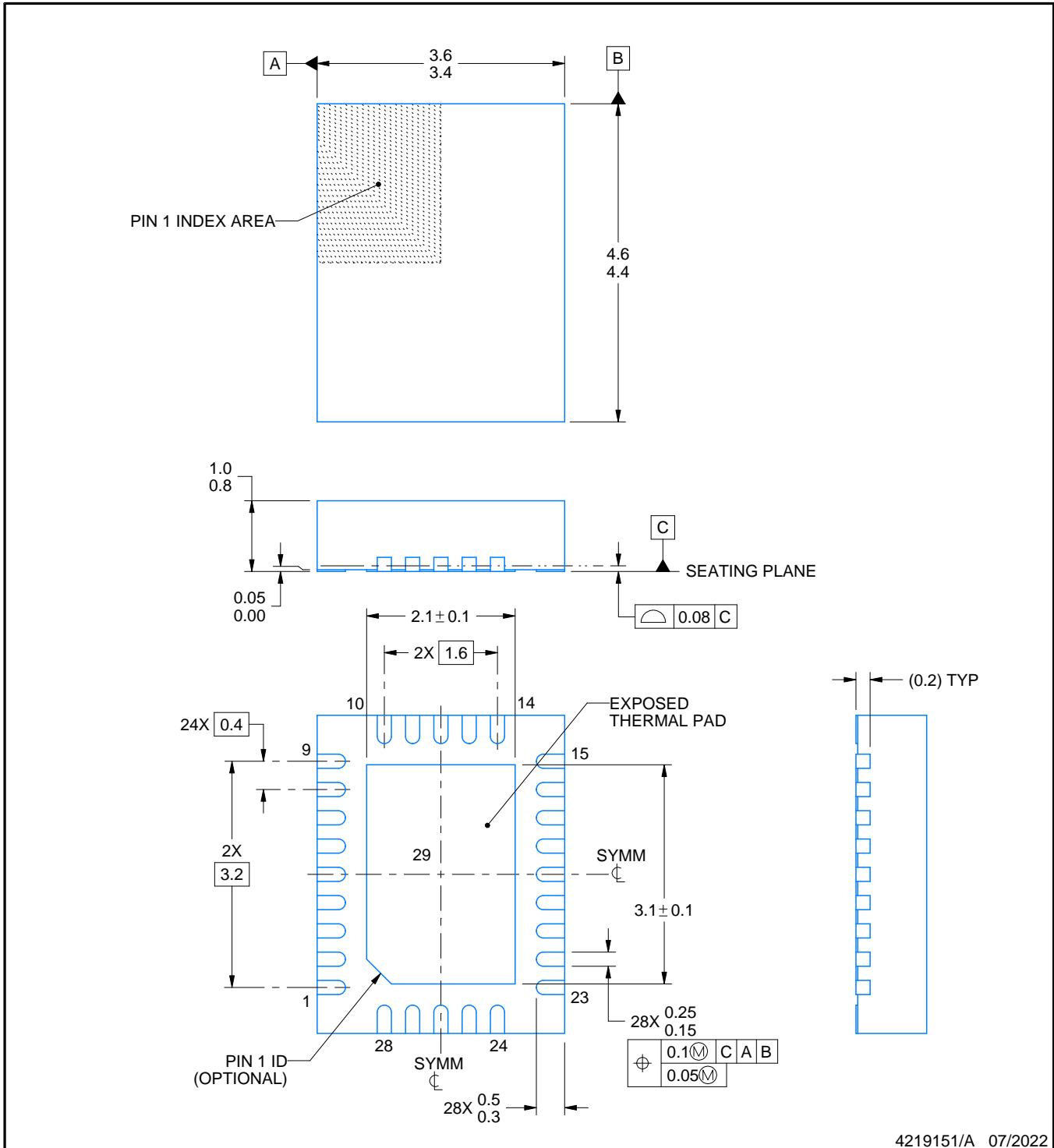
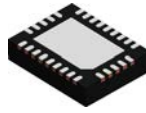

NOTES:

1. All linear dimensions are in millimeters. Any dimensions in parenthesis are for reference only. Dimensioning and tolerancing per ASME Y14.5M.
2. This drawing is subject to change without notice.
3. The package thermal pad must be soldered to the printed circuit board for thermal and mechanical performance.

# EXAMPLE BOARD LAYOUT

RVE0028A

VQFN - 1 mm max height

PLASTIC QUAD FLATPACK - NO LEAD

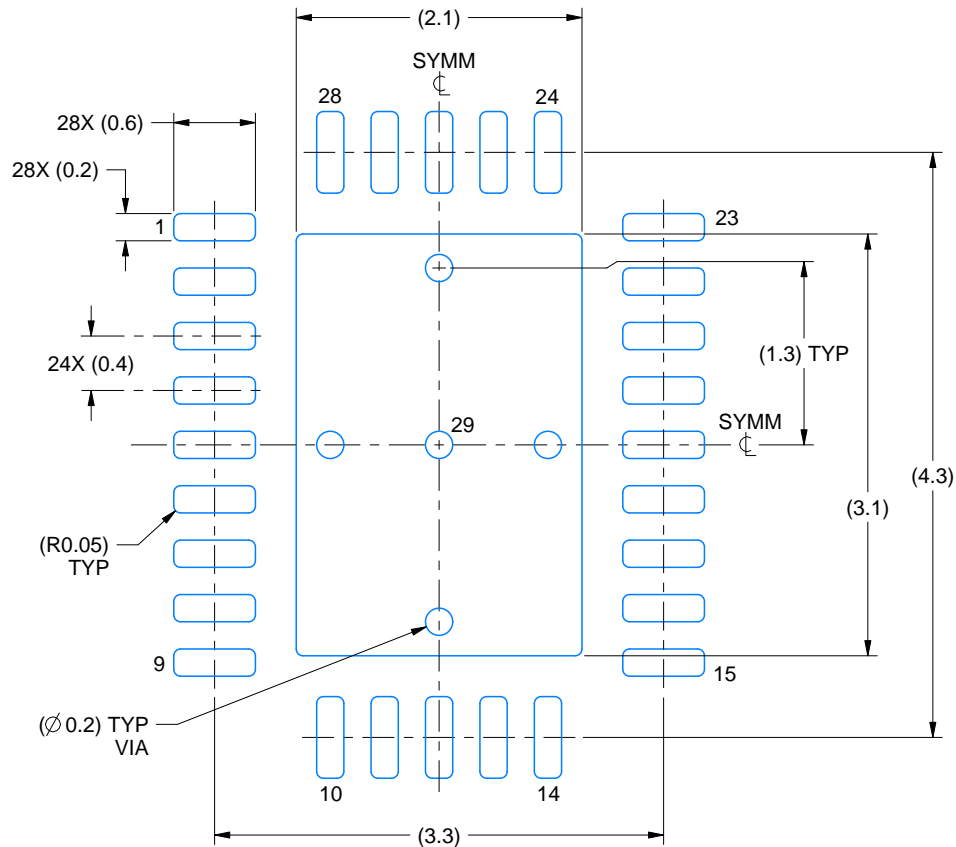

LAND PATTERN EXAMPLE  
EXPOSED METAL SHOWN  
SCALE:18X

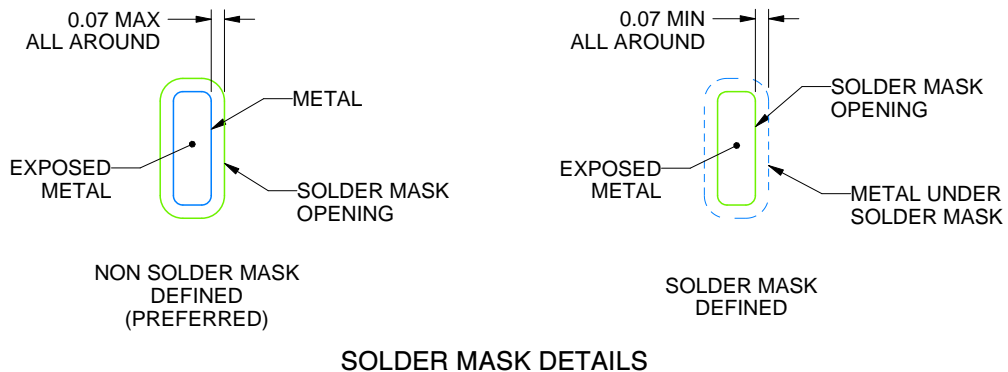

SOLDER MASK DETAILS

4219151/A 07/2022

NOTES: (continued)

4. This package is designed to be soldered to a thermal pad on the board. For more information, see Texas Instruments literature number SLUA271 ([www.ti.com/lit/sluea271](http://www.ti.com/lit/sluea271)).
5. Vias are optional depending on application, refer to device data sheet. If any vias are implemented, refer to their locations shown on this view. It is recommended that vias under paste be filled, plugged or tented.

# EXAMPLE STENCIL DESIGN

RVE0028A

VQFN - 1 mm max height

PLASTIC QUAD FLATPACK - NO LEAD

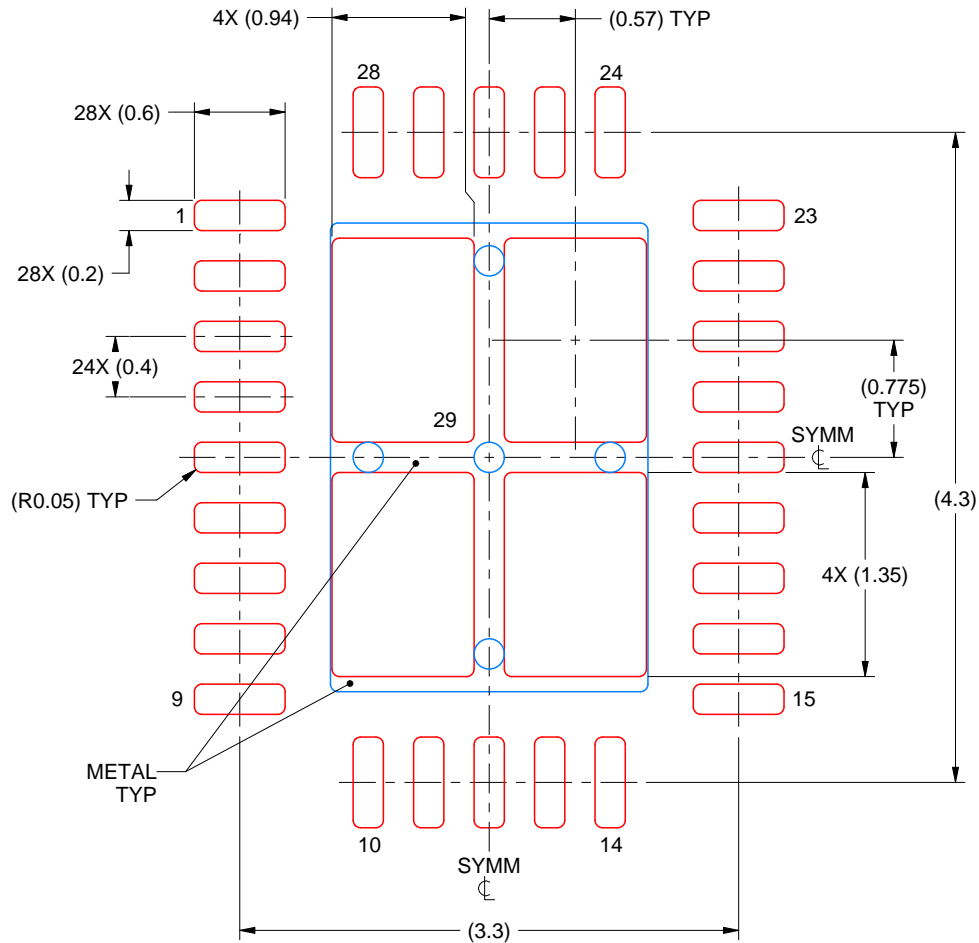

**SOLDER PASTE EXAMPLE**  
BASED ON 0.125 mm THICK STENCIL

EXPOSED PAD 29  
78% PRINTED SOLDER COVERAGE BY AREA UNDER PACKAGE  
SCALE:20X

4219151/A 07/2022

NOTES: (continued)

6. Laser cutting apertures with trapezoidal walls and rounded corners may offer better paste release. IPC-7525 may have alternate design recommendations.

## THERMAL PAD MECHANICAL DATA

RVE (R-PVQFN-N28)

PLASTIC QUAD FLATPACK NO-LEAD

### THERMAL INFORMATION

This package incorporates an exposed thermal pad that is designed to be attached directly to an external heatsink. The thermal pad must be soldered directly to the printed circuit board (PCB). After soldering, the PCB can be used as a heatsink. In addition, through the use of thermal vias, the thermal pad can be attached directly to the appropriate copper plane shown in the electrical schematic for the device, or alternatively, can be attached to a special heatsink structure designed into the PCB. This design optimizes the heat transfer from the integrated circuit (IC).

For information on the Quad Flatpack No-Lead (QFN) package and its advantages, refer to Application Report, QFN/SON PCB Attachment, Texas Instruments Literature No. SLUA271. This document is available at [www.ti.com](http://www.ti.com).

The exposed thermal pad dimensions for this package are shown in the following illustration.

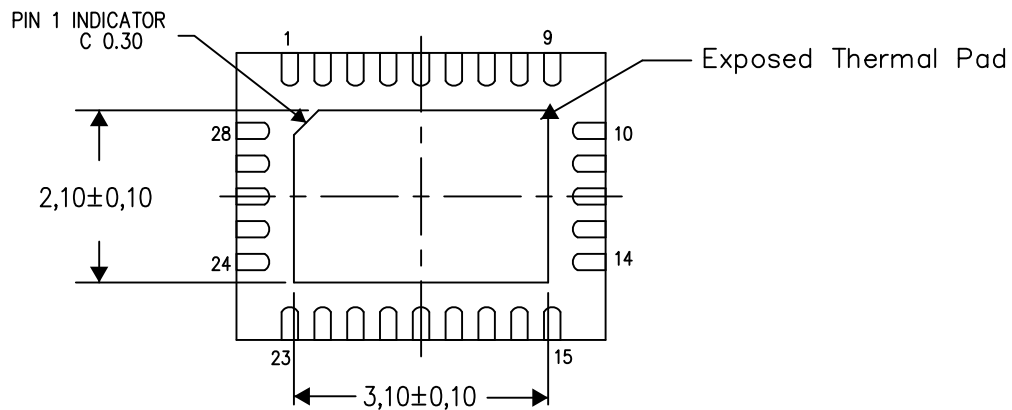

Bottom View

Exposed Thermal Pad Dimensions

4211776/E 04/15

NOTE: All linear dimensions are in millimeters

RVE (R-PWQFN-N28)

PLASTIC QUAD FLATPACK NO-LEAD

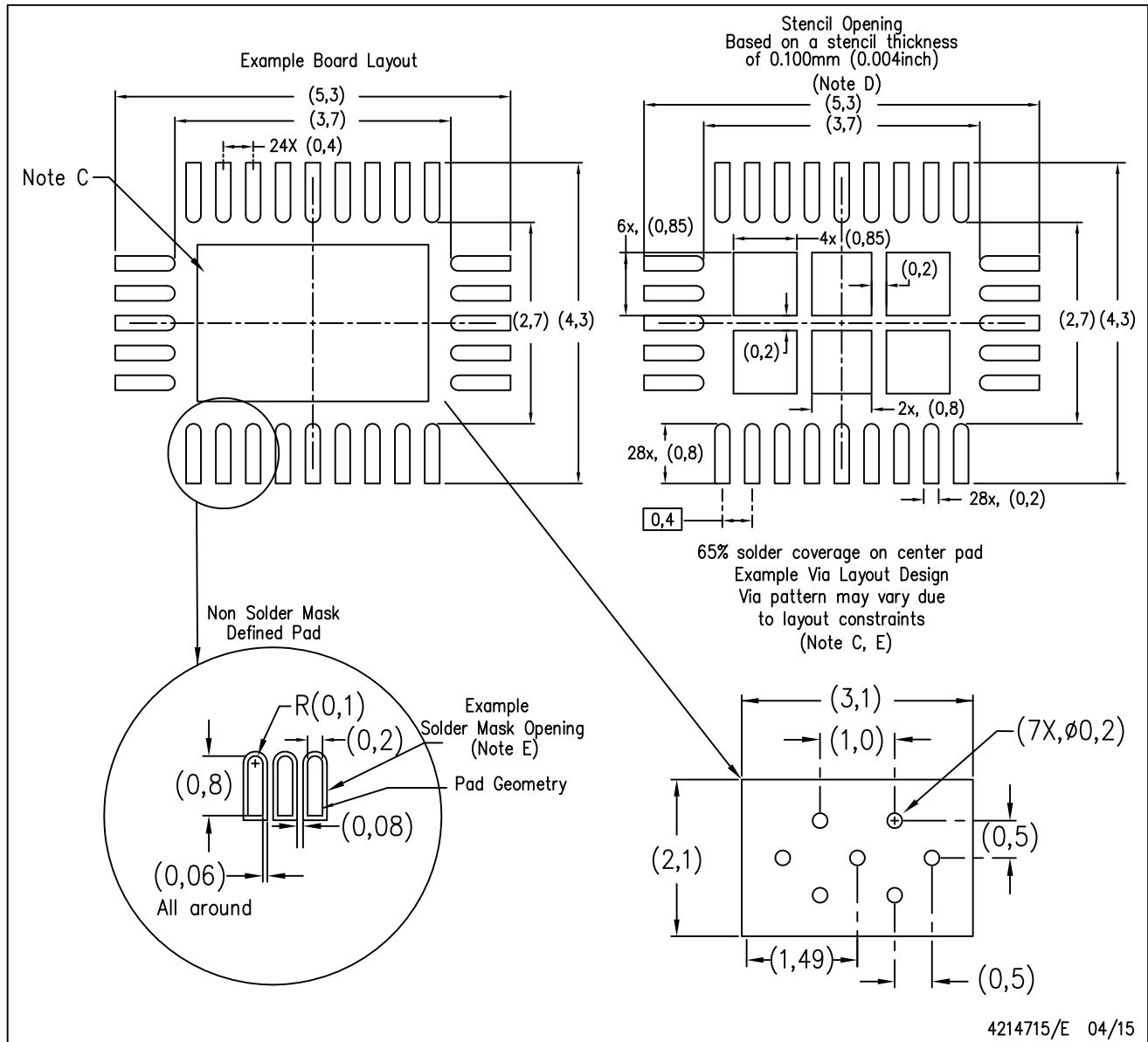

- NOTES:
- All linear dimensions are in millimeters.
  - This drawing is subject to change without notice.
  - This package is designed to be soldered to a thermal pad on the board. Refer to Application Note, Quad Flat-Pack Packages, Texas Instruments Literature No. SLUA271, and also the Product Data Sheets for specific thermal information, via requirements, and recommended board layout. These documents are available at [www.ti.com](http://www.ti.com) <<http://www.ti.com>>.
  - Laser cutting apertures with trapezoidal walls and also rounding corners will offer better paste release. Electroformed stencils offer adequate release at thicker values/lower Area Ratios. Customers should contact their board assembly site for stencil design recommendations. Refer to IPC 7525 for stencil design considerations.
  - Customers should contact their board fabrication site for minimum solder mask web tolerances between signal pads.

## IMPORTANT NOTICE AND DISCLAIMER

TI PROVIDES TECHNICAL AND RELIABILITY DATA (INCLUDING DATA SHEETS), DESIGN RESOURCES (INCLUDING REFERENCE DESIGNS), APPLICATION OR OTHER DESIGN ADVICE, WEB TOOLS, SAFETY INFORMATION, AND OTHER RESOURCES "AS IS" AND WITH ALL FAULTS, AND DISCLAIMS ALL WARRANTIES, EXPRESS AND IMPLIED, INCLUDING WITHOUT LIMITATION ANY IMPLIED WARRANTIES OF MERCHANTABILITY, FITNESS FOR A PARTICULAR PURPOSE OR NON-INFRINGEMENT OF THIRD PARTY INTELLECTUAL PROPERTY RIGHTS.

These resources are intended for skilled developers designing with TI products. You are solely responsible for (1) selecting the appropriate TI products for your application, (2) designing, validating and testing your application, and (3) ensuring your application meets applicable standards, and any other safety, security, regulatory or other requirements.

These resources are subject to change without notice. TI grants you permission to use these resources only for development of an application that uses the TI products described in the resource. Other reproduction and display of these resources is prohibited. No license is granted to any other TI intellectual property right or to any third party intellectual property right. TI disclaims responsibility for, and you will fully indemnify TI and its representatives against, any claims, damages, costs, losses, and liabilities arising out of your use of these resources.

TI's products are provided subject to [TI's Terms of Sale](#) or other applicable terms available either on [ti.com](https://www.ti.com) or provided in conjunction with such TI products. TI's provision of these resources does not expand or otherwise alter TI's applicable warranties or warranty disclaimers for TI products.

TI objects to and rejects any additional or different terms you may have proposed.

Mailing Address: Texas Instruments, Post Office Box 655303, Dallas, Texas 75265  
Copyright © 2023, Texas Instruments Incorporated