

DZ 系列

DZ Series

特点 Features

- IEC标准插座式一体化滤波器
IEC connector integrative filters
- 性价比高
High performance to cost make

应用 Applications

- 用于小型电子设备和电子测量仪器
Available for mini-electronic equipments and measuring instruments

技术参数 Technical Data

额定电压 Rated Voltage	250VAC
工作频率 Operating Frequency	50/60Hz
额定电流 Rated Current	1A-16A
耐压试验:(一分钟) Test Voltage (1min)	1500VDC (line/line) 1500VAC (line/ground)
气候类别 Climatic Category	25/085/21



型号 Model	端子方式 Terminal		额定电流 Rated Current (A)	接地电容量 Ground Capacitance (nF)	泄漏电流 Leakage Current ≤(mA)	放电电阻 Discharge Resistance (MΩ)	电路图 Circuit Diagram fig.	外形尺寸 Dimension fig.
	入 Input	出 Output						
DL-1DZ2			1	2.2	0.5		1	1
DL-3DZ2			3	3.3	0.5		1	1
DL-6DZ2			6	3.3	0.5		1	1
DL-10DZ2			10	4.7	0.8		1	1
DL-15DZ2			15	2.2	0.5	1	1	1
DL-1DZ210			1	2.2	0.5		1	2
DL-3DZ210			3	2.2	0.5		1	2
DL-6DZ210			6	2.2	0.5		1	2
DL-10DZ210			10	2.2	0.5		1	2
DL-1DZX			1	2.2	0.5		1	3
DL-3DZX			3	3.3	0.5		1	3
DL-6DZX			6	3.3	0.5		1	3
DL-10DZX			10	3.3	0.5		1	3
DL-15DZX			15	2.2	0.5	1	1	3
DL-1DZ2C			1	2.2	0.5		1	4
DL-3DZ2C			3	2.2	0.5		1	4
DL-6DZ2C			6	2.2	0.5		1	4
DL-10DZ2C			10	2.2	0.5		1	4
DL-3DZB21			3	4.7	0.8	1.5	2	5
DL-6DZB21			6	4.7	0.8	1.5	2	5
DL-10DZB21			10	3.3	0.5	1.5	2	6
DL-15DZB2			15	3.3	0.5	1.5	2	7
DL-16DZB2			16	10	1.7	0.68	1	8

电原理图 Typical Circuit Diagram

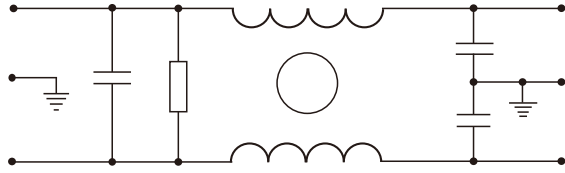

fig.1

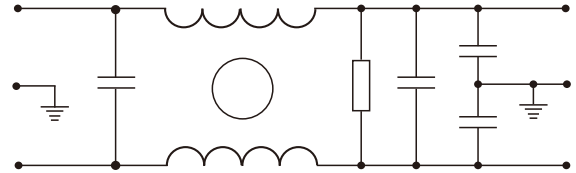

fig.2

外形尺寸 Outline Drawing and Dimensions (mm)

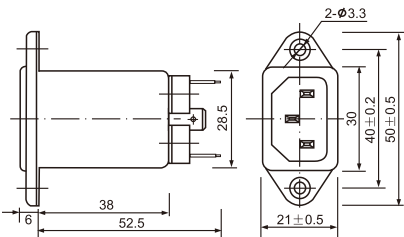

fig.1

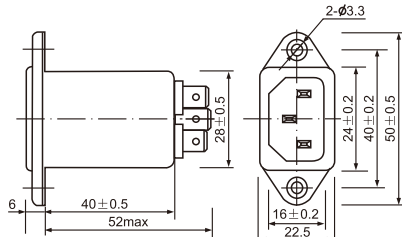

fig.2

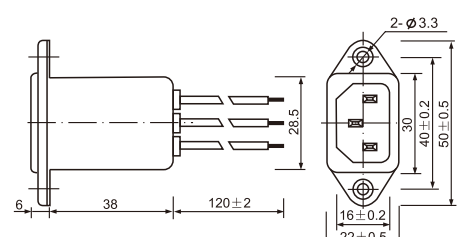

fig.3

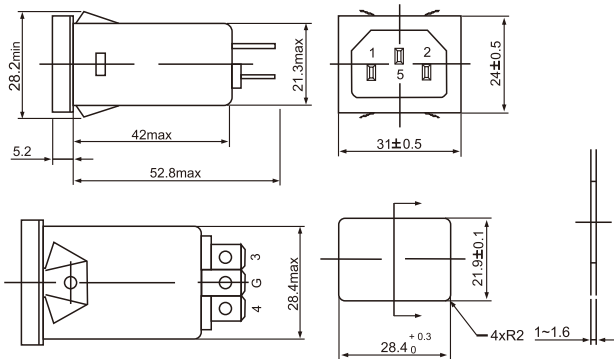

fig.4

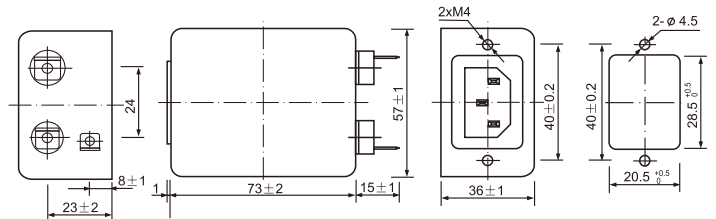

fig.5

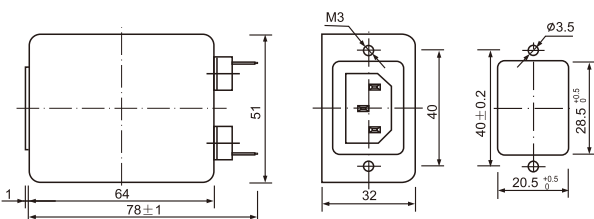

fig.6

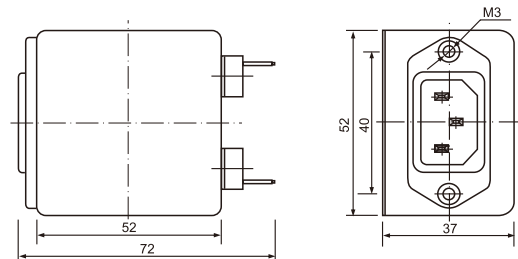

fig.7

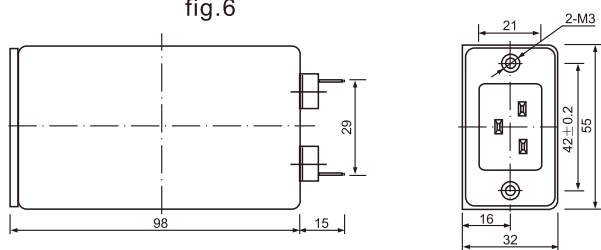
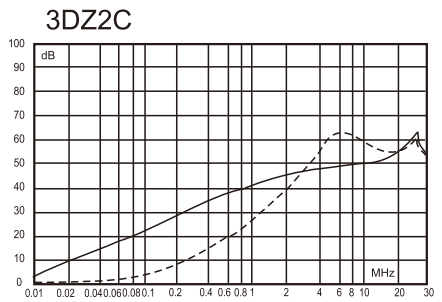
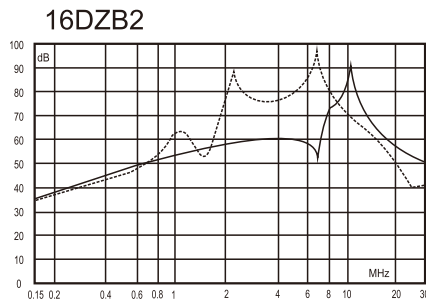
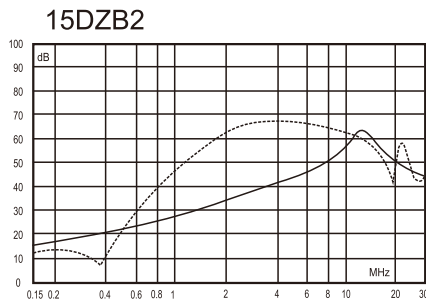
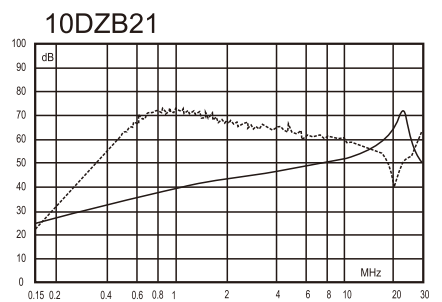
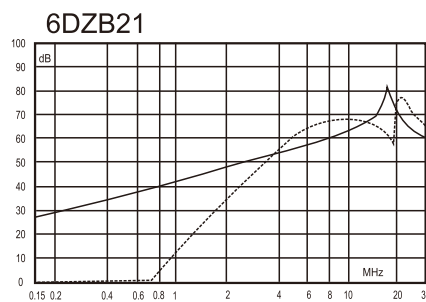
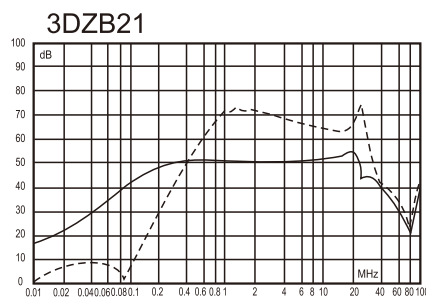
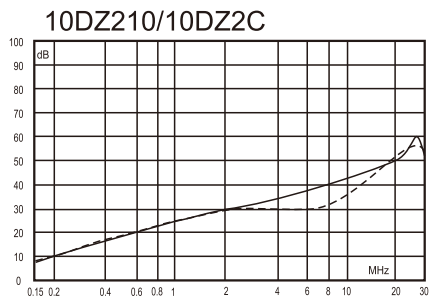
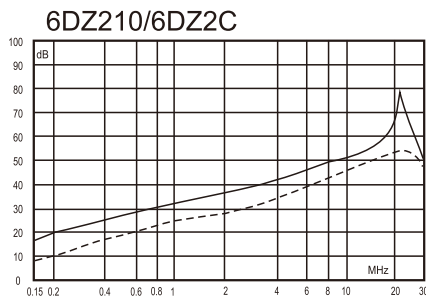
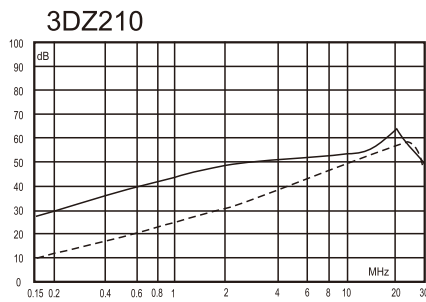
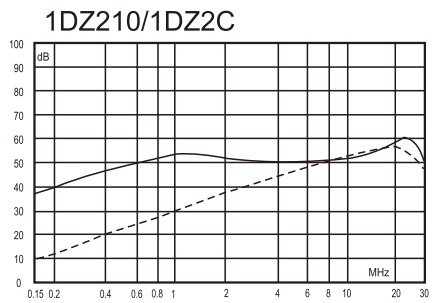
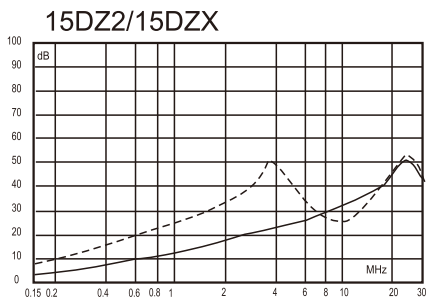
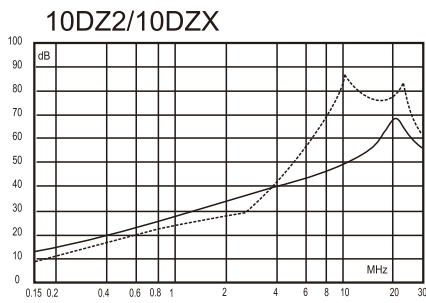
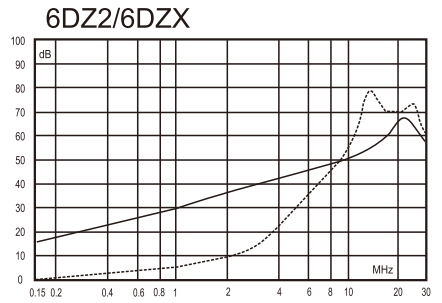
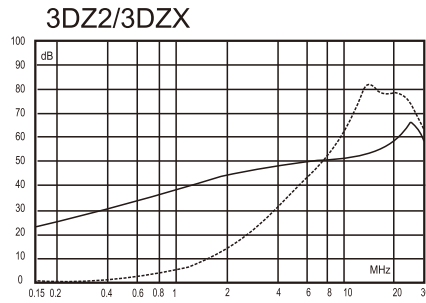
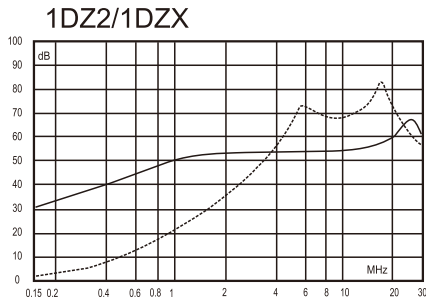

fig.8

插入损耗 Insertion Loss in dB

(50 Ω 测量系统, IEC/CISPR No.17 号出版物 Measured in 50 Ω system, as IEC/CISPR No. 17)



—— 共模(Common Mode)
 - - - - 差模(Differential Mode)