

76825-0006 SHOWN

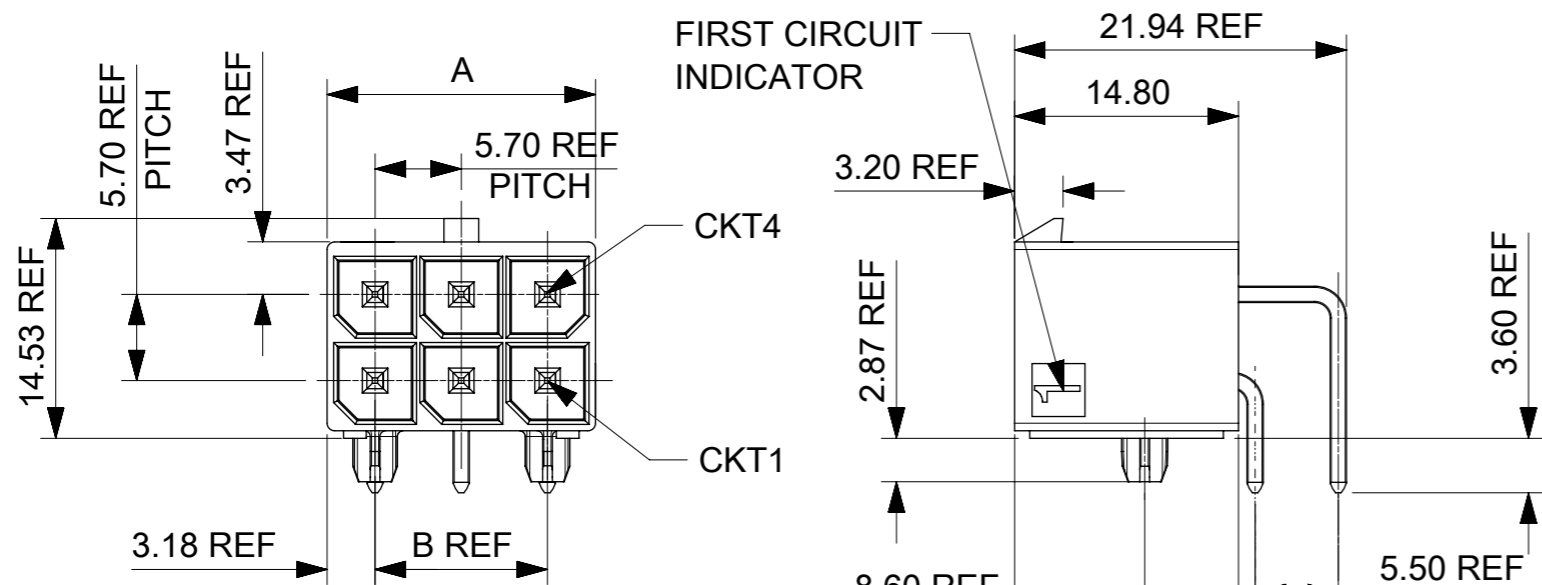

- NOTES:
- MATERIAL:
HOUSING LCP, UL94V-0, GLOW WIRE CAPABLE PER IEC-60335-1 5TH EDITION, COLOR: BLACK.
TERMINAL: HIGH CONDUCTIVITY COPPER.
 - TERMINAL PLATING:
(TIN) 1.52 MICROMETER MIN REFLOWED MATTE TIN OVER
1.27 MICROMETER MIN NICKEL OVERALL.
(15 GOLD) 0.38 MICROMETER MIN SELECTIVE GOLD ON CONTACT AREA
WITH 2.54 MICROMETER MIN SELECTIVE TIN ON SOLDER AREA
BOTH OVER 1.27 MICROMETER MIN NICKEL OVERALL.
(30 GOLD) 0.76 MICROMETER MIN SELECTIVE GOLD ON CONTACT AREA
WITH 2.54 MICROMETER MIN SELECTIVE TIN ON SOLDER AREA
BOTH OVER 1.27 MICROMETER MIN NICKEL OVERALL.
 - PRODUCT SPECIFICATION PS-76823-100, 1720631000-PS
 - PACKAGING: TRAY PACKED PER MOLEX SPECIFICATION PK-76825-0000, WHILE T&R IS 1720640900.
 - PART MATES WITH MOLEX PART NUMBER 170001 AND 171692 SERIES.
 - APPLICATION SPECIFICATION: AS-76823-100, 768232000-AS
 - PARTS CONFORM TO CLASS "B" REQUIREMENTS OF COSMETIC SPECIFICATION PS-45499-002.
 - TO AVOID INTERFERENCE BETWEEN RECEPTACLE AND PCB, HEADER MUST BE PLACED WITHIN 20.6 MAX FROM EDGE OF PCB AS SHOWN FOR 4 THROUGH 12 CIRCUITS.
FOR 2 CIRCUIT PARTS THIS DIMENSION IS 15.1 MAX.

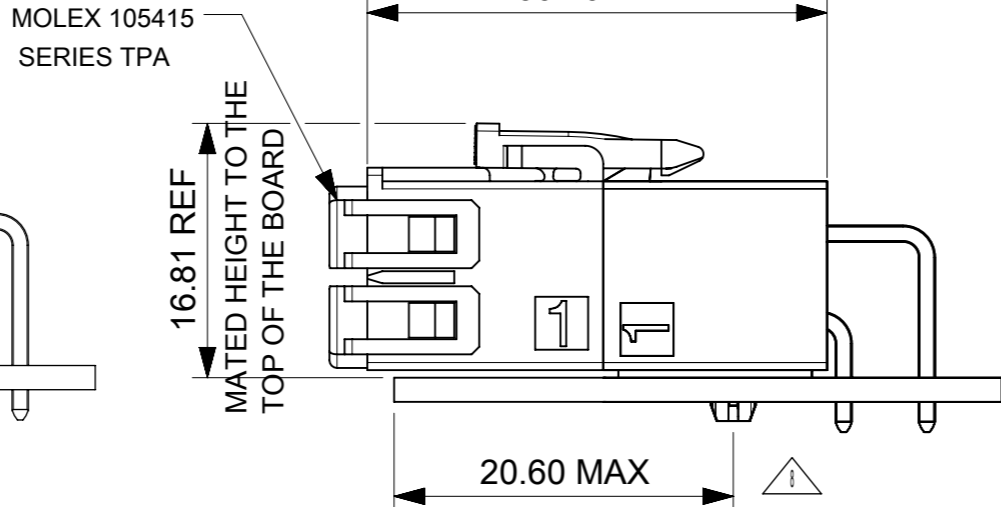
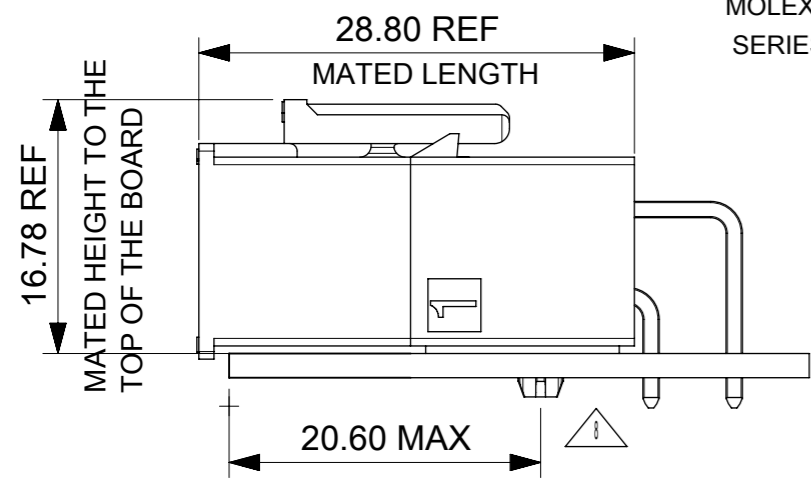
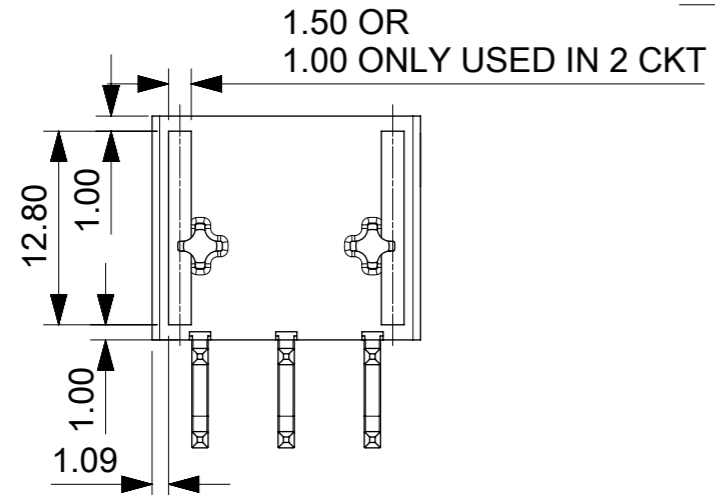

THIS DRAWING CONTAINS INFORMATION THAT IS PROPRIETARY TO MOLEX ELECTRONIC TECHNOLOGIES, LLC AND SHOULD NOT BE USED WITHOUT WRITTEN PERMISSION									
DIMENSION UNITS		SCALE		CURRENT REV DESC:					
mm		NTS		<p>molex</p> <p>MEGA-FIT RIGHT ANGLE HEADER R/A HEADER ASSY 2-12 CKT</p> <p>PRODUCT CUSTOMER DRAWING</p> <p>DOCUMENT NUMBER: SD-76825-0100 DOC TYPE: PSD DOC PART: 000 REVISION: E3</p> <p>MATERIAL NUMBER: SEE TABLE CUSTOMER: GENERAL MARKET SHEET NUMBER: 1 OF 3</p>					
GENERAL TOLERANCES (UNLESS SPECIFIED)									
ANGULAR TOL ± 3.0°									
4 PLACES ±		EC NO: 720543							
3 PLACES ±		DRWN: WYATTH5 2022/08/30							
2 PLACES ± 0.25		CHK'D: XQZHANG 2022/09/08							
1 PLACE ± 0.36		APPR: XQZHANG 2022/09/08							
0 PLACES ±		INITIAL REVISION:							
DRAFT WHERE APPLICABLE MUST REMAIN WITHIN DIMENSIONS		THIRD ANGLE PROJECTION		DRAWING: A3-SIZE		SERIES: 76825		MATERIAL NUMBER: SEE TABLE	

4.18 REF

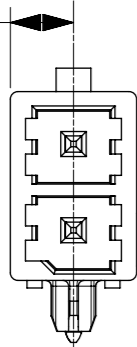

2CKT

3.18 REF

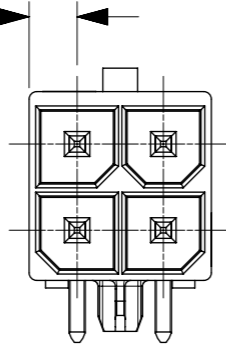

4CKT

3.18 REF

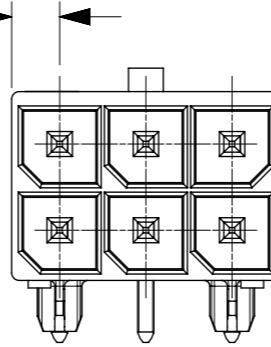

6CKT

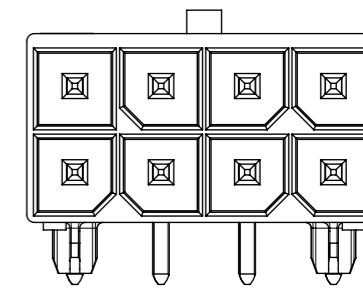

8CKT

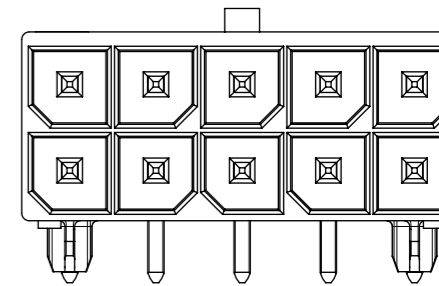

10CKT

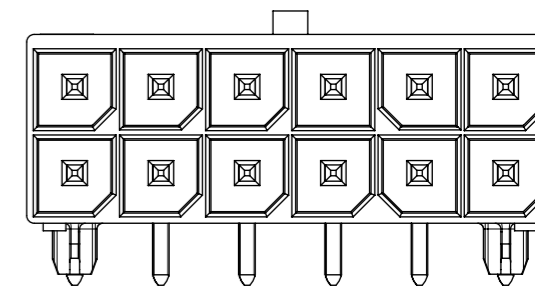

12CKT

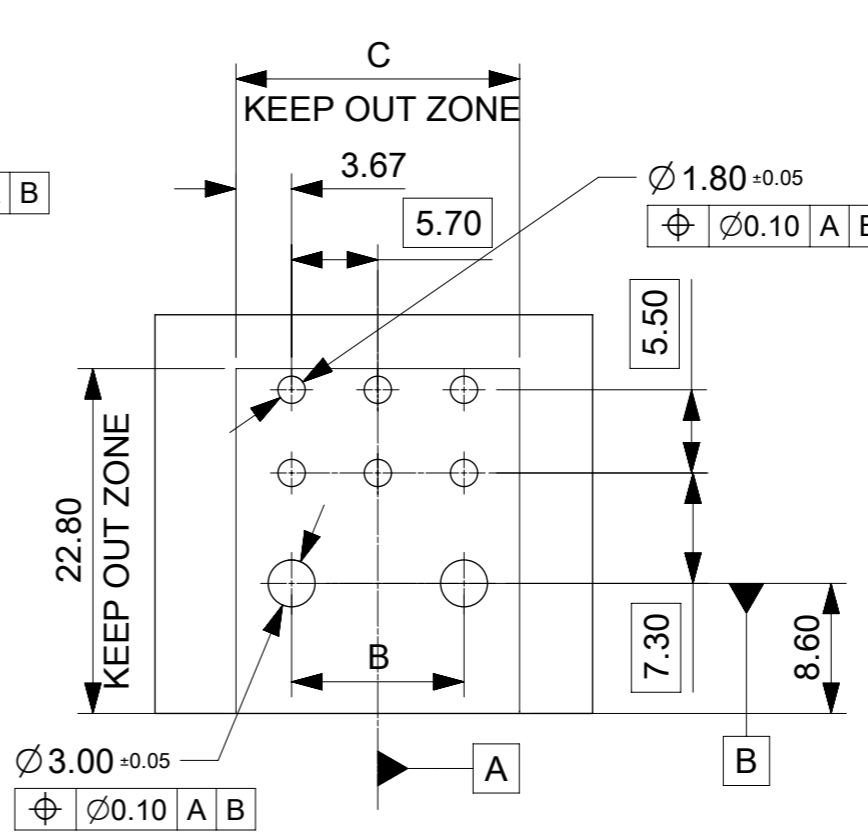
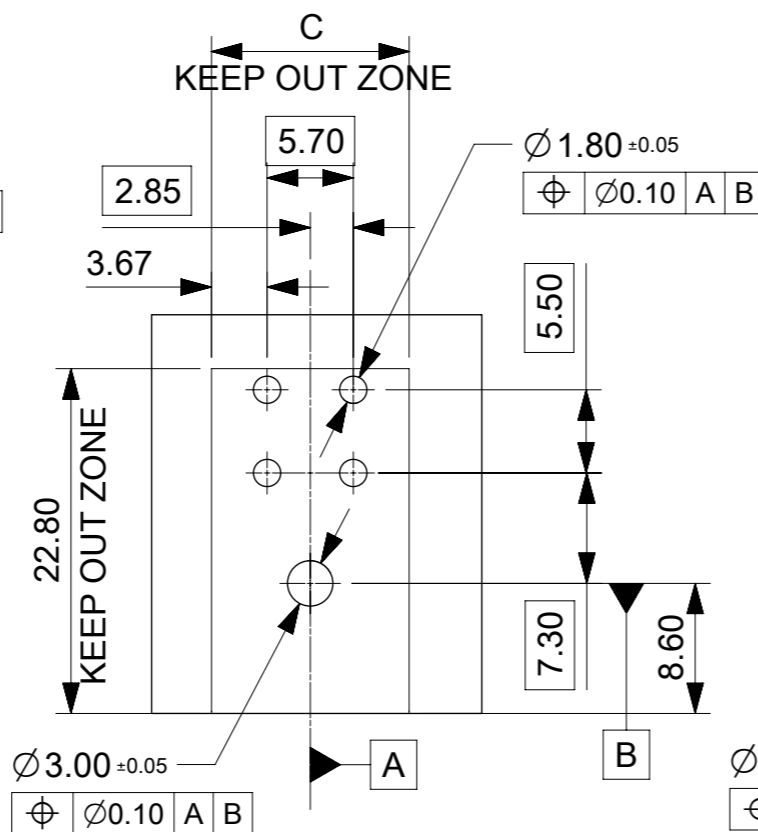
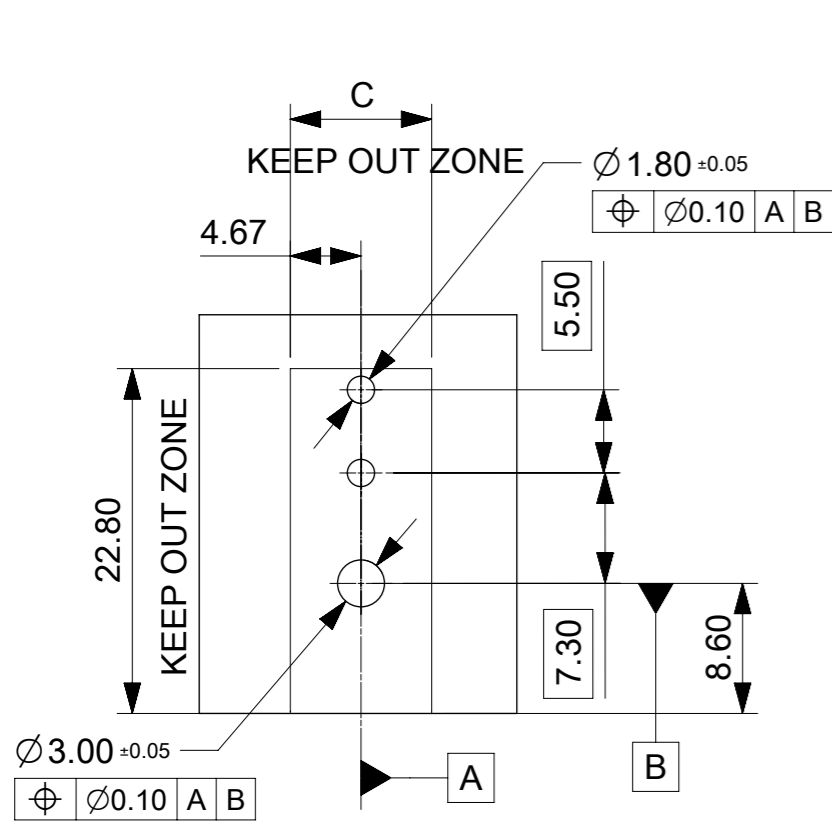

PCB LAYOUT: COMPONENT SIDE
RECOMENDED PCB THICKNESS: 1.58 MM/.062 IN TO 2.36 MM/.093 IN

PCB LAYOUT: COMPONENT SIDE
RECOMENDED PCB THICKNESS: 1.58 MM/.062 IN TO 2.36 MM/.093 IN

PCB LAYOUT: COMPONENT SIDE
RECOMENDED PCB THICKNESS: 1.58 MM/.062 IN TO 2.36 MM/.093 IN

THIS DRAWING CONTAINS INFORMATION THAT IS PROPRIETARY TO MOLEX ELECTRONIC TECHNOLOGIES, LLC AND SHOULD NOT BE USED WITHOUT WRITTEN PERMISSION		CURRENT REV DESC:		molex	
DIMENSION UNITS	SCALE				
mm	NTS			MEGA-FIT RIGHT ANGLE HEADER R/A HEADER ASSY 2-12 CKT	
GENERAL TOLERANCES (UNLESS SPECIFIED)				PRODUCT CUSTOMER DRAWING	
ANGULAR TOL	± 3.0 °			DOCUMENT NUMBER	
4 PLACES	±	EC NO: 720543	2022/08/30	SD-76825-0100	
3 PLACES	±	DRWN: WYATTH5	2022/09/08	DOC TYPE	DOC PART
2 PLACES	± 0.25	CHK'D: XQZHANG	2022/09/08	PSD	000
1 PLACE	± 0.36	APPR: XQZHANG		REVISION	
0 PLACES	±	INITIAL REVISION:	2010/11/15	E3	
DRAFT WHERE APPLICABLE MUST REMAIN WITHIN DIMENSIONS		DRWN: MKARADIMAS	2012/06/13	SHEET NUMBER	
THIRD ANGLE PROJECTION		APPR: APATEL		SEE TABLE	GENERAL MARKET
DRAWING		SERIES	MATERIAL NUMBER	CUSTOMER	
A3-SIZE		76825	GENERAL MARKET	2 OF 3	

	CKT SIZE	PART NO.	PLATING	DIM A	DIM B	DIM C	PK SPEC
	2	76825-0002	TIN	8.35	N/A	9.35	TRAY
	4	76825-0004	TIN	12.05	N/A	13.05	
	6	76825-0006	TIN	17.75	11.4	18.75	
	8	76825-0008	TIN	23.45	17.1	24.45	
	10	76825-0010	TIN	29.15	22.8	30.15	
	12	76825-0012	TIN	34.85	28.5	35.85	
	2	172064-0002	15 GOLD	8.35	N/A	9.35	
	4	172064-0004	15 GOLD	12.05	N/A	13.05	
	6	172064-0006	15 GOLD	17.75	11.4	18.75	
	8	172064-0008	15 GOLD	23.45	17.1	24.45	
	10	172064-0010	15 GOLD	29.15	22.8	30.15	
	12	172064-0012	15 GOLD	34.85	28.5	35.85	
	2	172064-1002	30 GOLD	8.35	N/A	9.35	
	4	172064-1004	30 GOLD	12.05	N/A	13.05	
	6	172064-1006	30 GOLD	17.75	11.4	18.75	
	8	172064-1008	30 GOLD	23.45	17.1	24.45	
	10	172064-1010	30 GOLD	29.15	22.8	30.15	
	12	172064-1012	30 GOLD	34.85	28.5	35.85	
							TAPE&REEL
*	2	76825-0902	TIN	8.35	N/A	9.35	
*	4	76825-0904	TIN	12.05	N/A	13.05	
*	6	76825-0906	TIN	17.75	11.4	18.75	
	8	76825-0908	TIN	23.45	17.1	24.45	
*	10	76825-0910	TIN	29.15	22.8	30.15	
	12	76825-0912	TIN	34.85	28.5	35.85	
*	2	172064-0902	15 GOLD	8.35	N/A	9.35	
*	4	172064-0904	15 GOLD	12.05	N/A	13.05	
*	6	172064-0906	15 GOLD	17.75	11.4	18.75	
	8	172064-0908	15 GOLD	23.45	17.1	24.45	
*	10	172064-0910	15 GOLD	29.15	22.8	30.15	
	12	172064-0912	15 GOLD	34.85	28.5	35.85	
*	2	172064-1902	30 GOLD	8.35	N/A	9.35	
*	4	172064-1904	30 GOLD	12.05	N/A	13.05	
*	6	172064-1906	30 GOLD	17.75	11.4	18.75	
	8	172064-1908	30 GOLD	23.45	17.1	24.45	
*	10	172064-1910	30 GOLD	29.15	22.8	30.15	
	12	172064-1912	30 GOLD	34.85	28.5	35.85	

* DESIGNATES PART NOT RELEASED
CONTACT FACTORY FOR AVAILABILITY.

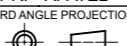
THIS DRAWING CONTAINS INFORMATION THAT IS PROPRIETARY TO MOLEX ELECTRONIC TECHNOLOGIES, LLC AND SHOULD NOT BE USED WITHOUT WRITTEN PERMISSION													
DIMENSION UNITS		SCALE		CURRENT REV DESC:									
mm		NTS											
GENERAL TOLERANCES (UNLESS SPECIFIED)				EC NO: 720543 DRWN: WYATTH5 2022/08/30 CHK'D: XQZHANG 2022/09/08 APPR: XQZHANG 2022/09/08 INITIAL REVISION: DRWN: MKARADIMAS 2010/11/15 APPR: APATEL 2012/06/13				MEGA-FIT RIGHT ANGLE HEADER R/A HEADER ASSY 2-12 CKT					
ANGULAR TOL ± 3.0 °								PRODUCT CUSTOMER DRAWING					
4 PLACES ±								DOCUMENT NUMBER		DOC TYPE		DOC PART	
3 PLACES ±								SD-76825-0100		PSD		000	
2 PLACES ± 0.25												REVISION	
1 PLACE ± 0.36								E3					
0 PLACES ±													
DRAFT WHERE APPLICABLE MUST REMAIN WITHIN DIMENSIONS				THIRD ANGLE PROJECTION		DRAWING		SERIES					
						A3-SIZE		76825					
						MATERIAL NUMBER		CUSTOMER					
						SEE TABLE		GENERAL MARKET					
								SHEET NUMBER					
								3 OF 3					