

TRIH

MAIN FEATURES

- Miniature heavy-duty relays
- Single-Pole, 10 Amp PC Board
- SPST and SPDT configurations
- 5KV dielectric coil to contacts
- Sealed & Unsealed types available
- UL、cUL and TUV recognized.

APPLICATIONS

- Microwave Ovens, Facsimiles, Refrigerators
- Air Conditioners, Stereo Equipment,
- Copier, TV Set, Vending Machines,
- Temperature Controllers, etc.

ORDERING INFORMATION

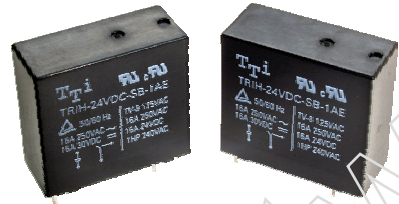

Option Socket :

Please refer appendix P102

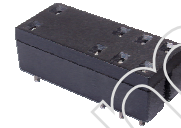

- OD07-0017A
- OD07-0018A
- OD07-0019A
- OD07-0020A

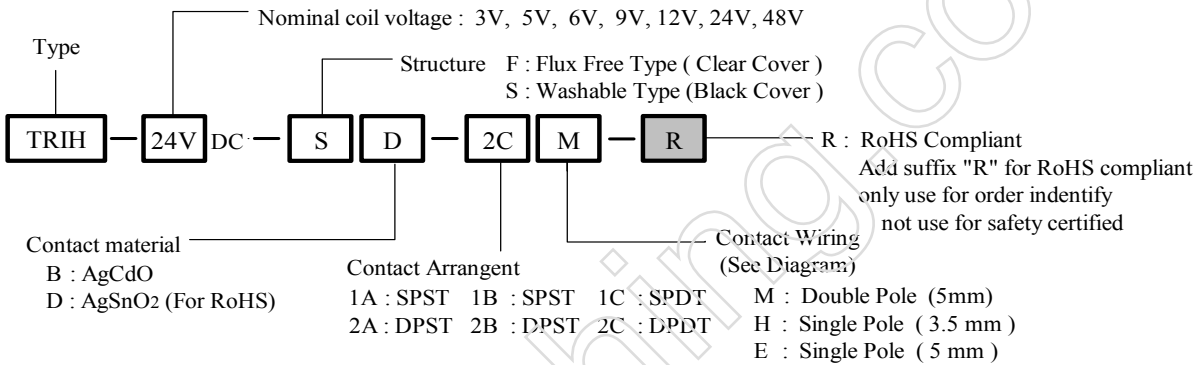

DIMENSION (unit:mm)

DRILLING (unit:mm)

WIRING DIAGRAM

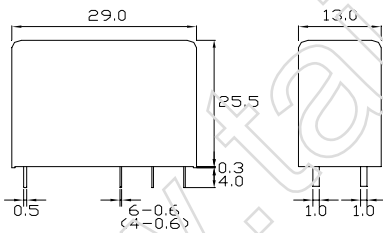

TRIH-1CE

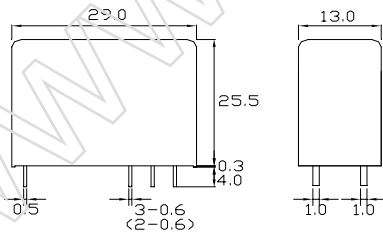
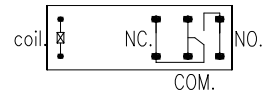
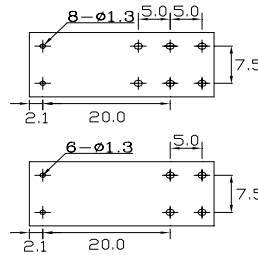

TRIH-1CH

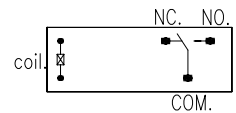
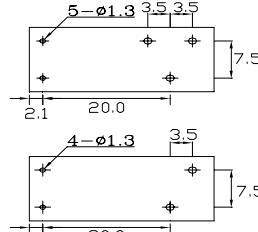

TRIH-1AH

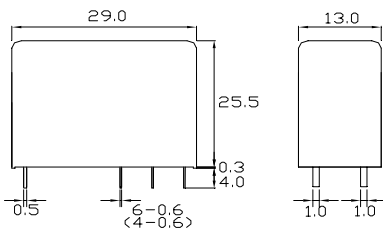
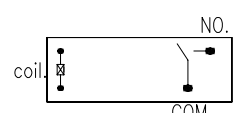
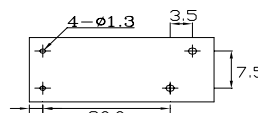

TRIH-2CM

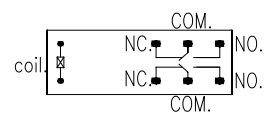
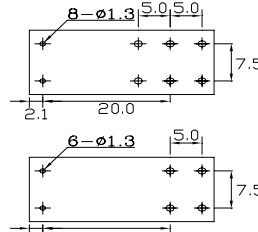

TRIH-2AM

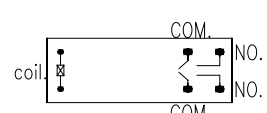
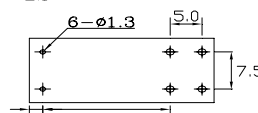

COIL DATA CHART (AT20°C)

Nominal Voltage (VDC)	Nominal Current (mA±10%)	Coil Resistance Ω (±10%)	Power Consumption (mW)	Pick-Up Voltage VDC(Max.)	Drop-out Voltage VDC(Min.)	Max.allowable Voltage (VDC)
3	176	17	Approx. 530	80% Max.	10% Min.	110% of nominal voltage
5	106	47				
6	88.2	68				
9	56.2	160				
12	43.6	275				
24	21.8	1100±15%				
48	11.5	4170±15%	75% Max.			

CONTACT RATING

Arrangement	E-Type		H-Type		M-Type	
	SPST-NO (1a)	SPDT (1c)	SPST-NO (1a)	SPDT (1c)	DPST-NO (2a)	DPDT (2c)
Resistive load (cosΦ=1)	16A 250VAC 16A 24VDC 1HP 240VAC TV-8 125VAC(N.O.)		10A 250AC 10A 30VDC 1/3HP 250VAC TV-5 125VAC		10A 250VAC 10A 30VDC 5A 250VAC 5A 30VDC TV-3 125VAC	
Carrying current	16A		10A		5A	
Max. switching voltage	277VAC, 30VDC		277VAC, 30VDC		250VAC, 30VDC	
Max. switching current	16A		10A		5A	
Max. switching power	4000VA 300W	2000VA 192W	2500VA 300W	1875VA 150W	1250VA 150W	500VA 90W
Min. permissible load	DC 5V 100mA			DC 5V 10mA		
Contact material	Ag Alloy					

PERFORMANCE (at initial value)

Item	Type	TRI-H
Contact Resistance		50mΩ Max.
Operation time		15msec Max. (at nominal voltage)
Release time		10msec Max. (at nominal voltage)
Dielectric strength	between coil & contact. between contact sets. between open contacts.	5000VAC. for 1 minute 3000VAC. for 1 minute 1000VAC. for 1 minute
Insulation Resistance		100MΩ Min. (at 500VDC)
Operating frequency		20ops/minute
Ambient temperature		Storage : -40 to +70°C Operating : -40 to +70°C
Humidity		35 to 85% RH
Vibration resistance	Functional : Destructive :	10 to 55 Hz, 1.5mm double amplitude 10 to 55 Hz, 1.5mm double amplitude
Shock resistance	Functional : Destructive :	Min, 10 G Min, 100G
Life expectancy	Mechanical : Electrical :	DC 2x10 ⁷ operations 1x10 ⁵ operations (at rated load)
Weight		Approx. 17grs.
UL & cUL		E156406
TUV		R50053235 / R50058882 / R50058874

REFERENCE DATA

Maximum Switched Power

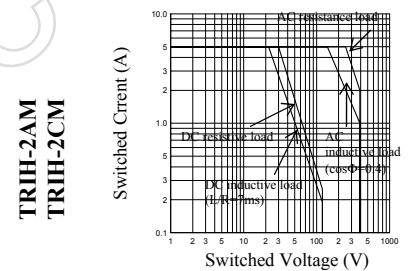
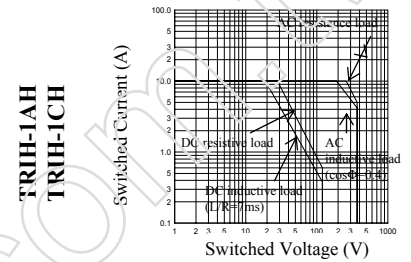
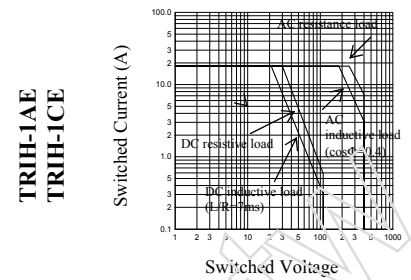

Electrical Life Expectancy

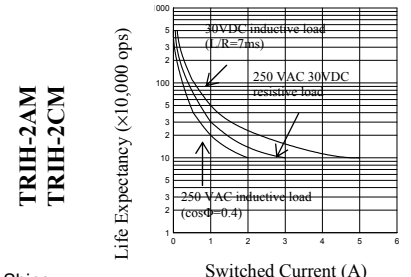
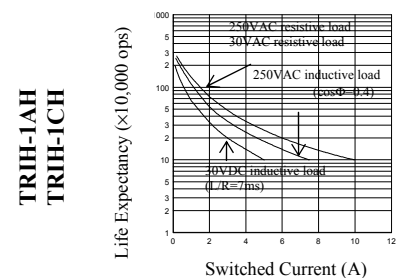
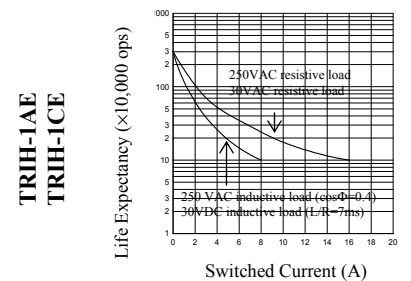

This datasheet for reference and subject to change without notice. Please double check final specification with Tai-Shing.