

1W isolated DC-DC converter  
Fixed input voltage, unregulated dual/single output



### FEATURES

- Compact SIP package
- Industry standard pin-out
- High efficiency up to 81%
- I/O isolation test voltage 3k VDC
- Operating ambient temperature range: -40°C to +105°C
- EN60950, UL60950 approved



Patent Protection RoHS



E\_S-1WR2 & F\_S-1WR2 series is specially designed for applications where an isolated voltage is required in a distributed power supply system. It is suitable for:

1. Where the voltage of the input power supply is stable (voltage variation:  $\pm 10\%V_{in}$ );
2. Where isolation is necessary between input and output (isolation voltage  $\leq 3000VDC$ );
3. Where do not has high requirement of line regulation, load regulation and low ripple noise;
4. Such as: pure digital circuits, low frequency analog circuits and relay-driven circuits.etc.

### Selection Guide

Certification	Part No.	Input Voltage (VDC)	Output		Full Load Efficiency (%) Min./Typ.	Capacitive Load* ( $\mu F$ ) Max.
		Nominal (Range)	Voltage (VDC)	Current (mA) Max./Min.		
--	E0312S-1WR2	3.3 (2.97-3.63)	$\pm 12$	$\pm 42/\pm 5$	72/76	100
	F0303S-1WR2		3.3	303/30	69/73	
	F0305S-1WR2		5	200/20	74/78	
	F0324S-1WR2		24	42/5	74/78	
UL/CE	E0505S-1WR2	5 (4.5-5.5)	$\pm 5$	$\pm 100/\pm 10$	76/80	100
	E0509S-1WR2		$\pm 9$	$\pm 56/\pm 6$	76/80	
	E0512S-1WR2		$\pm 12$	$\pm 42/\pm 5$	76/80	
	E0515S-1WR2		$\pm 15$	$\pm 33/\pm 4$	77/81	
	E0524S-1WR2		$\pm 24$	$\pm 21/\pm 2$	77/81	
UL/CE	F0503S-1WR2	5 (4.5-5.5)	3.3	303/30	69/73	220
	F0505S-1WR2		5	200/20	76/80	
	F0509S-1WR2		9	111/12	76/80	
	F0512S-1WR2		12	83/9	76/80	
	F0515S-1WR2		15	67/7	77/81	
	F0524S-1WR2		24	42/5	77/81	
--	E0909S-1WR2	9 (8.1-9.9)	$\pm 9$	$\pm 56/\pm 6$	76/80	100
	F0909S-1WR2		9	111/12	76/80	
	F0915S-1WR2		15	67/7	76/80	
UL/CE	E1205S-1WR2	12 (10.8-13.2)	$\pm 5$	$\pm 100/\pm 10$	76/80	100
	E1212S-1WR2		$\pm 12$	$\pm 42/\pm 5$	77/81	
	E1215S-1WR2		$\pm 15$	$\pm 33/\pm 4$	77/81	
	E1224S-1WR2		$\pm 24$	$\pm 21/\pm 2$	76/80	
UL/CE	F1203S-1WR2	12 (10.8-13.2)	3.3	303/30	71/75	220
	F1205S-1WR2		5	200/20	76/80	
	F1209S-1WR2		9	111/12	76/80	
	F1212S-1WR2		12	83/9	76/80	
	F1215S-1WR2		15	67/7	77/81	
	F1224S-1WR2		24	42/5	77/81	

--	E1505S-1WR2	15 (13.5-16.5)	±5	±100/±10	76/80	100	
	E1515S-1WR2		±15	±33/±4	77/81		
CE	F1505S-1WR2		5	200/20	76/80	220	
--	F1509S-1WR2		9	111/12	76/80		
	F1512S-1WR2		12	83/9	76/80		
CE	F1515S-1WR2		15	67/7	77/81		
--	F1524S-1WR2		24	42/4	76/80		
UL/CE	E2405S-1WR2		24 (21.6-26.4)	±5	±100/±10		76/80
	E2409S-1WR2			±9	±56/±6	76/80	
	E2412S-1WR2			±12	±42/±5	77/81	
	E2415S-1WR2	±15		±33/±4	75/79		
	E2424S-1WR2	±24		±21/±2	76/80		
--	F2403S-1WR2	3.3		303/30	71/75	220	
UL/CE	F2405S-1WR2	5		200/20	75/79		
	F2409S-1WR2	9		111/12	76/80		
	F2412S-1WR2	12		83/9	77/81		
	F2415S-1WR2	15		67/7	77/81		
	F2424S-1WR2	24	42/5	77/81			

Note: \* The specified maximum capacitive load for positive and negative output is identical.

### Input Specifications

Item	Operating Conditions	Min.	Typ.	Max.	Unit
Input Current (full load / no-load)	3.3 VDC input	--	415/25	--/70	mA
	5 VDC input	--	274/20	--/60	
	9 VDC input	--	139/20	--/55	
	12 VDC input	--	114/15	--/50	
	15 VDC input	--	84/10	--/35	
	24 VDC input	--	58/7	--/30	
Surge Voltage (1sec. max.)	3.3 VDC input	-0.7	--	5	VDC
	5 VDC input	-0.7	--	9	
	9 VDC input	-0.7	--	12	
	12 VDC input	-0.7	--	18	
	15 VDC input	-0.7	--	21	
	24 VDC input	-0.7	--	30	
Input Filter		Capacitance filter			
Hot Plug		Unavailable			

### Output Specifications

Item	Operating Conditions	Min.	Typ.	Max.	Unit	
Voltage Accuracy		See output regulation curve(Fig. 1)				
Linear Regulation	Input voltage change: ±1%	3.3 VDC output	--	--	±1.5	--
		Others	--	--	±1.2	
Load Regulation	10%-100% load	3.3VDC output	--	18	--	%
		5VDC output	--	12	--	
		9VDC output	--	9	--	
		12VDC output	--	8	--	
		15VDC output	--	7	--	
		24VDC output	--	6	--	
Ripple & Noise*	20MHz bandwidth	The output voltage is 12VDC and under	--	30	--	mVp-p
		15VDC and 24VDC output voltage	--	60	--	

Temperature Coefficient	100% load	--	--	±0.03	%/°C
Short-circuit Protection**	E03xxS-1WR2/F03xxS-1WR2/E0524S-1WR2/ F0524S-1WR2/F1524S-1WR2/ E24xxS-1WR2/ F24xxS-1WR2	--	--	1	s
	Others	Continuous, self-recovery			

Notes: \* The "parallel cable" method is used for Ripple and Noise test, please refer to DC-DC Converter Application Notes for specific information.  
 \*\*Supply voltage must be discontinued at the end of short circuit duration for E03xxS-1WR2/F03xxS-1WR2/E0524S-1WR2/F0524S-1WR2/F1524S-1WR2/E24xxS-1WR2/F24xxS-1WR2 models.

### General Specifications

Item	Operating Conditions	Min.	Typ.	Max.	Unit
Isolation	Input-output Electric Strength Test for 1 minute with a leakage current of 1mA max.	3000	--	--	VDC
Insulation Resistance	Input-output resistance at 500VDC	1000	--	--	MΩ
Isolation Capacitance	Input-output capacitance at 100kHz/0.1V	--	20	--	pF
Operating Temperature	Derating when operating temperature ≥ 85°C, (see Fig. 2)	-40	--	105	°C
Storage Temperature		-55	--	125	
Case Temperature Rise	T <sub>a</sub> =25°C	--	25	--	
Pin Soldering Resistance Temperature	Soldering spot is 1.5mm away from case for 10 seconds	--	--	300	
Storage Humidity	Non-condensing	--	--	95	%RH
Switching Frequency	100% load, nominal input voltage	--	100	--	KHz
MTBF	MIL-HDBK-217F@25°C	3500	--	--	K hours

### Mechanical Specifications

Case Material	Black Epoxy resin; flame-retardant and heat-resistant(UL94 V-0)
Dimensions	19.50 x 6.00 x 9.30 mm
Weight	2.4g(Typ.)
Cooling Method	Free air convection

### Electromagnetic Compatibility (EMC)

Emissions	CE	CISPR32/EN55032	CLASS B (see Fig. 4 for recommended circuit)
	RE	CISPR32/EN55032	CLASS B (see Fig. 4 for recommended circuit)
Immunity	ESD	E_S-1WR2	IEC/EN61000-4-2 Contact ±6KV perf. Criteria B
		F_S-1WR2	IEC/EN61000-4-2 Contact ±8KV perf. Criteria B

### Typical Characteristic Curves

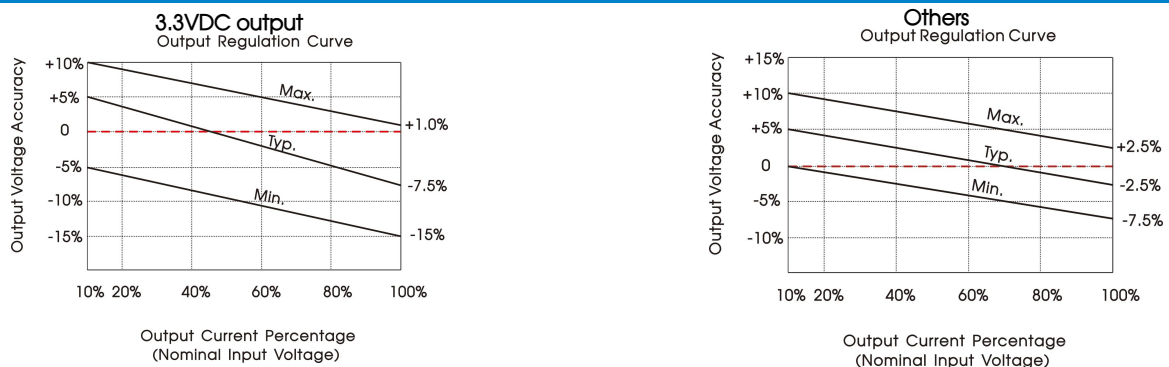

Fig. 1

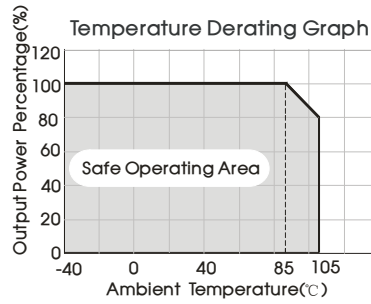
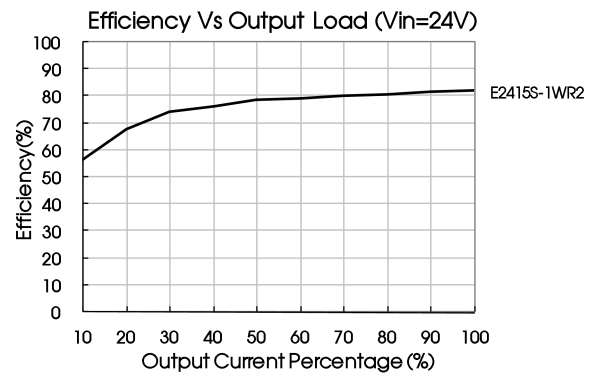
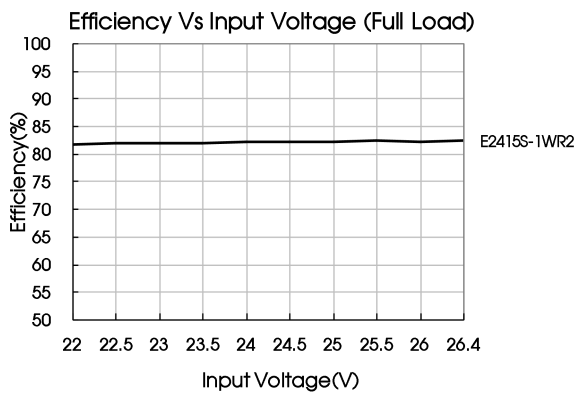
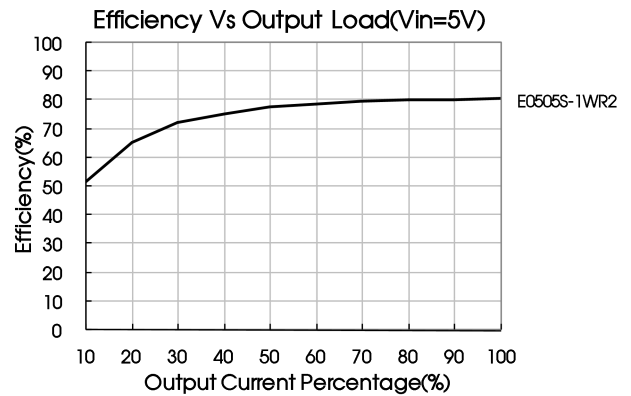
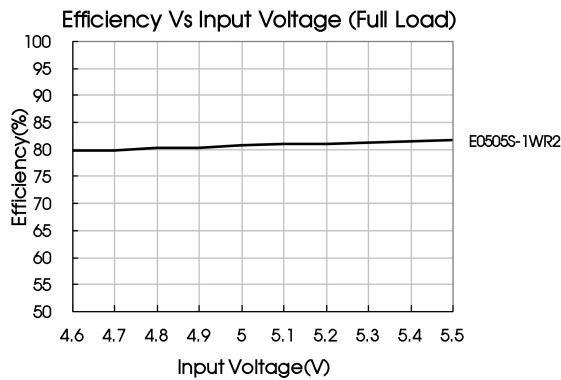

Fig. 2



## Design Reference

### 1. Typical application

Input and/or output ripple can be further reduced, by connecting a filter capacitor from the input and/or output terminals to ground as shown in Fig.3.

Choosing suitable filter capacitor values is very important for a smooth operation of the modules, particularly to avoid start-up problems caused by capacitor values that are too high. For recommended input and output capacitor values refer to Table 1.

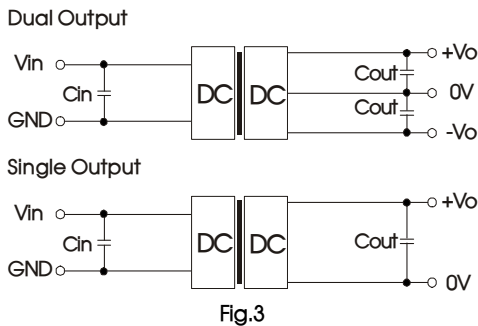

Table 1: Recommended capacitive load value table

Vin (VDC)	Cin (μF)	Single output (VDC)	Cout (μF)	Dual output (VDC)	Cout (μF)
3.3/5	4.7	3.3/5/9	10	±5	4.7
9/12	2.2	12	2.2	±9/±12	1
15	2.2	15/24	1	±15/±24	0.47
24	1	--	--	--	--

2. EMC (CLASS B) compliance circuit

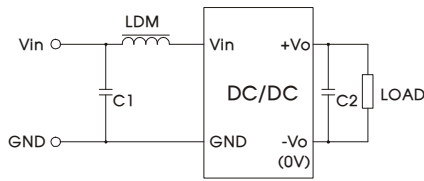

Fig. 4

	Input voltage(VDC)	3.3/5/9/12/15/24
Emissions	C1	4.7μF /50V
	C2	Refer to the Cout in Fig.3
	LDM	6.8μH

3. Output load requirements

For a reliable and efficient operation of the converter, the minimum load should never be less than 10% of the rated output load. If the total required output power is below 10%, a parallel bleeding resistor is required on the output, ensuring that the sum of the power consumption is always maintained at 10% minimum.

4. For additional information, please refer to DC-DC converter application notes on

[www.mornsun-power.com](http://www.mornsun-power.com)

Dimensions and Recommended Layout

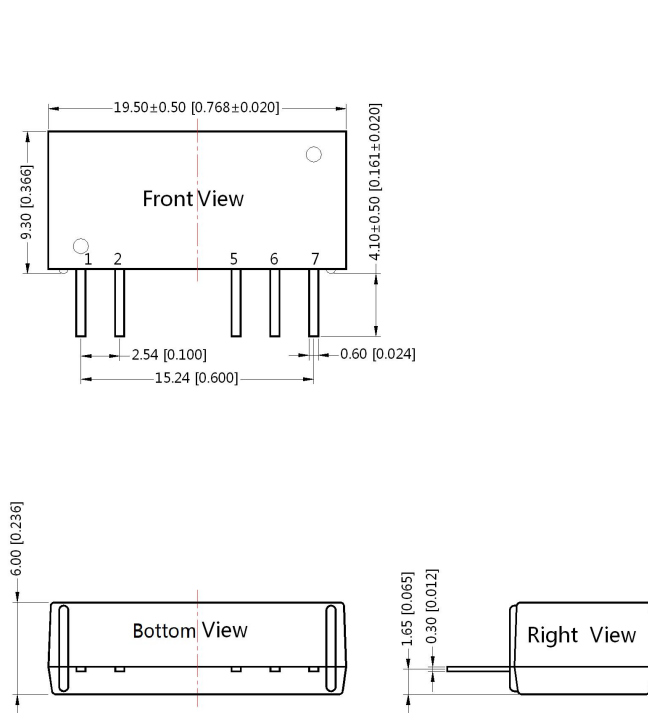

Note:  
Unit: mm[inch]  
Pin section tolerances: ±0.10[±0.004]  
General tolerances: ±0.25[±0.010]

THIRD ANGLE PROJECTION

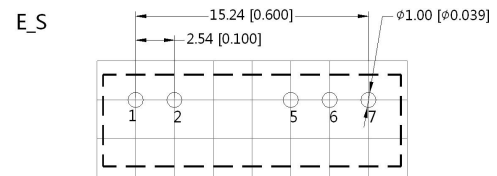
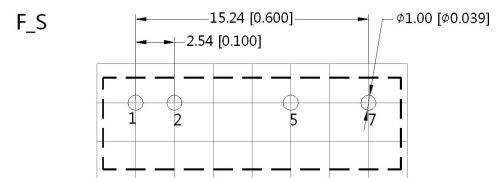

Note: Grid 2.54\*2.54mm

Pin	Pin-Out	
	F_S	E_S
1	Vin	Vin
2	GND	GND
5	0V	-Vo
6	No Pin	0V
7	+Vo	+Vo

Notes:

1. For additional information on Product Packaging please refer to [www.mornsun-power.com](http://www.mornsun-power.com). Packaging bag number : 58200029;
2. If the product is not operated within the required load range, the product performance cannot be guaranteed to comply with all parameters in the datasheet;
3. The maximum capacitive load offered were tested at nominal input voltage and full load;
4. Unless otherwise specified, parameters in this datasheet were measured under the conditions of  $T_a=25^{\circ}\text{C}$ , humidity<75%RH with nominal input voltage and rated output load;
5. All index testing methods in this datasheet are based on our company corporate standards;
6. We can provide product customization service, please contact our technicians directly for specific information;
7. Products are related to laws and regulations: see "Features" and "EMC";
8. Our products shall be classified according to ISO14001 and related environmental laws and regulations, and shall be handled by qualified units.

## MORNSUN Guangzhou Science & Technology Co., Ltd.

Address: No. 5, Kehui St. 1, Kehui development center, Science Ave., Guangzhou Science City, Huangpu district, Guangzhou, P.R. China

Tel: 86-20-38601850

Fax: 86-20-38601272

E-mail: [info@mornsun.cn](mailto:info@mornsun.cn)

[www.mornsun-power.com](http://www.mornsun-power.com)