

TPD4E1B06 4-Channel Ultra Low Leakage ESD Protection Device

1 Features

- Ultra Low Leakage Current 0.5 nA (Max)
- Transient Protection for 4 I/O Lines
 - IEC 61000-4-2 Contact Discharge ± 12 kV
 - IEC 61000-4-2 Air-Gap Discharge ± 15 kV
 - IEC 61000-4-5 Surge 3.0 A (8/20 μ s)
- I/O Capacitance 0.7 pF (Typ)
- Bi-directional TVS Diode Array
- Low ESD Clamping Voltage
- Industrial Temperature Range: -40°C to 125°C
- Small, Easy-to-Route DRL and DCK Packages

2 Applications

- Glucose Meter
- Tablets
- GPS
- Portable Media Players
- TV
- Set-top Box

4 Simplified Schematic

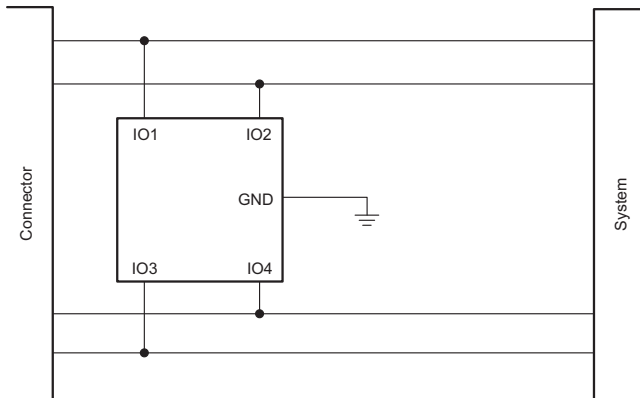

3 Description

The TPD4E1B06 is a 4-channel bi-directional Transient Voltage Suppressor (TVS) diode array. This device features ultra low leakage current (0.5 nA) for precision analog measurements. The ± 12 kV contact and ± 15 kV air gap ESD protection exceeds IEC 61000-4-2 level 4 requirements. The TPD4E1B06's 0.7 pF line capacitance makes it suitable for precision analog, USB2.0, Ethernet, SATA, LVDS, and 1394 interfaces.

Device Information⁽¹⁾

PART NUMBER	PACKAGE	BODY SIZE (NOM)
TPD4E1B06	SC70 (6)	2.00 mm x 2.10 mm
	SOT (6)	1.60 mm x 1.60 mm

(1) For all available packages, see the orderable addendum at the end of the datasheet.

Functional Block Diagram

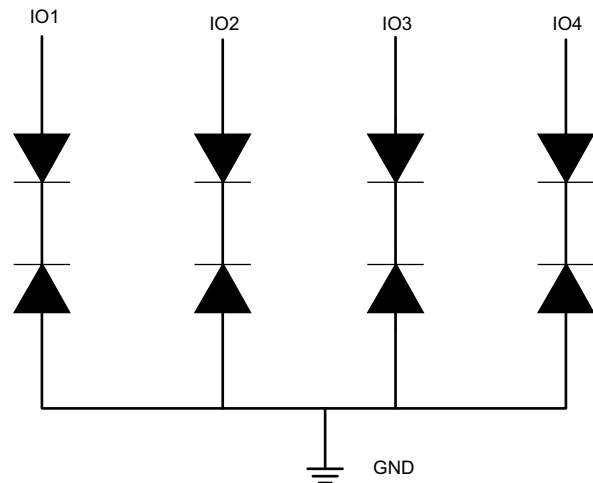

Table of Contents

1 Features	1	8.2 Functional Block Diagram	7
2 Applications	1	8.3 Feature Description	7
3 Description	1	8.4 Device Functional Modes	7
4 Simplified Schematic	1	9 Application and Implementation	8
5 Revision History	2	9.1 Application Information	8
6 Pin Configuration and Functions	3	9.2 Typical Application	8
7 Specifications	4	10 Layout	10
7.1 Absolute Maximum Ratings	4	10.1 Layout Guidelines	10
7.2 Handling Ratings	4	10.2 Layout Examples	10
7.3 Recommended Operating Conditions	4	11 Device and Documentation Support	11
7.4 Thermal Information	4	11.1 Trademarks	11
7.5 Electrical Characteristics	4	11.2 Electrostatic Discharge Caution	11
7.6 Typical Characteristics	5	11.3 Glossary	11
8 Detailed Description	7	12 Mechanical, Packaging, and Orderable Information	11
8.1 Overview	7		

5 Revision History

Changes from Revision B (May 2014) to Revision C

Page

- Changed 2 device names from TPD4E6B06 to TPD4E1B06 **8**

Changes from Revision A (January 2013) to Revision B

Page

- Added DRL package to datasheet..... **1**
- Changed I_{PP} , peak pulse current from 3.5 A to 3.0 A..... **4**
- Added Handling Ratings table. **4**
- Added Recommended Operating Conditions table. **4**
- Changed Electrical Characteristics table to reflect operating conditions at 25 °C. **4**
- Added MIN V_{RWM} value of -5.5 V. **4**
- Changed V_{CLAMP} at $I_{PP} = 1$ A from 10.5 V to 10.9 V. **4**
- Changed Line Capacitance TYP value from 1 pF to 0.7 pF. **4**
- Added Line Capacitance MAX value of 0.95 pF. **4**
- Changed I_{LEAK} from MAX of 10 nA to 0.5 nA **4**

Changes from Original (December 2012) to Revision A

Page

- Fixed "f" units typo from GHz to MHz for C_L parameter in ELECTRICAL CHARACTERISTICS table. **4**

6 Pin Configuration and Functions

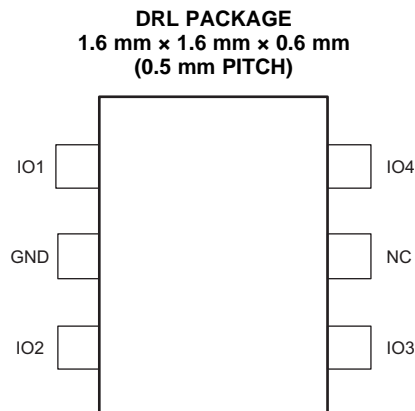
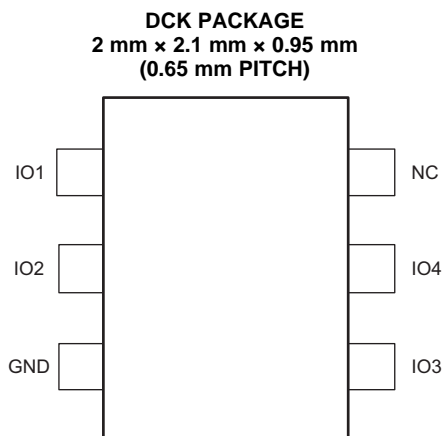

Pin Functions

NAME	PIN NO.		TYPE	DESCRIPTION
	DCK	DRL		
	IO1	1		
IO2	2	3	I/O	ESD protected channel. Connect to data line as close to the connector as possible.
IO3	4	4	I/O	ESD protected channel. Connect to data line as close to the connector as possible.
IO4	5	6	I/O	ESD protected channel. Connect to data line as close to the connector as possible.
GND	3	2	GND	Ground
NC	6	5	NC	Not internally connected

7 Specifications

7.1 Absolute Maximum Ratings

over operating free-air temperature range (unless otherwise noted)

	MIN	MAX	UNIT
Operating temperature range	–40	125	°C
I_{PP} , peak pulse current (tp = 8/20 μ s), IO pin to GND		3.0	A
P_{PP} , peak pulse power (tp = 8/20 μ s)		45	W

7.2 Handling Ratings

	MIN	MAX	UNIT	
T_{stg} Storage temperature range	–65	155	°C	
$V_{(ESD)}$ Electrostatic discharge	Human body model (HBM), per ANSI/ESDA/JEDEC JS-001, all pins ⁽¹⁾	–4.0	4.0	kV
	Charged device model (CDM), per JEDEC specification JESD22-C101, all pins ⁽²⁾	–1.5	1.5	
	IEC 61000-4-2 contact ESD	–12	12	
	IEC 61000-4-2 air-gap ESD	–15	15	

- (1) JEDEC document JEP155 states that 500-V HBM allows safe manufacturing with a standard ESD control process. Pins listed as 4 kV may actually have higher performance.
- (2) JEDEC document JEP157 states that 250-V CDM allows safe manufacturing with a standard ESD control process. Pins listed as 1.5 kV may actually have higher performance.

7.3 Recommended Operating Conditions

over operating free-air temperature range (unless otherwise noted)

	MIN	MAX	UNIT
V_{IO} The voltage between any two device pins should not exceed 5.5 V	–5.5	5.5	V
T_A Operating free-air temperature	–40	125	°C

7.4 Thermal Information

THERMAL METRIC ⁽¹⁾	TPD4E1B06		UNIT
	DCK	DRL	
	6 PINS	6 PINS	
$R_{\theta JA}$ Junction-to-ambient thermal resistance	227.3	233.4	°C/W
$R_{\theta JC(top)}$ Junction-to-case (top) thermal resistance	79.5	95.5	
$R_{\theta JB}$ Junction-to-board thermal resistance	72.1	68.1	
Ψ_{JT} Junction-to-top characterization parameter	3.6	7.6	
Ψ_{JB} Junction-to-board characterization parameter	70.4	67.9	

- (1) For more information about traditional and new thermal metrics, see the *IC Package Thermal Metrics* application report, [SPRA953](#).

7.5 Electrical Characteristics

 $T_A = 25^\circ\text{C}$

PARAMETER	TEST CONDITION	MIN	TYP	MAX	UNIT
V_{RWM} Reverse stand-off voltage		–5.5		5.5	V
V_{CLAMP} Clamp voltage with ESD strike, IO to GND	$I_{PP} = 1$ A, tp = 8/20 μ Sec, from I/O to GND or GND to I/O		10.9		V
	$I_{PP} = 3$ A, tp = 8/20 μ Sec, from I/O to GND or GND to I/O		14.5		V
R_{DYN} Dynamic resistance	$I_{TLP} = 10$ A to 20 A, I/O to GND		1		Ω
	$I_{TLP} = 10$ A to 20 A, GND to I/O		0.8		
C_L Line capacitance	f = 1 MHz, $V_{BIAS} = 2.5$ V		0.7	0.95	pF
V_{BR} Break-down voltage	$I_{IO} = 1$ mA, from I/O to GND or GND to I/O	7		9.5	V
I_{LEAK} Leakage current	$V_{IO} = 2.5$ V			0.5	nA

7.6 Typical Characteristics

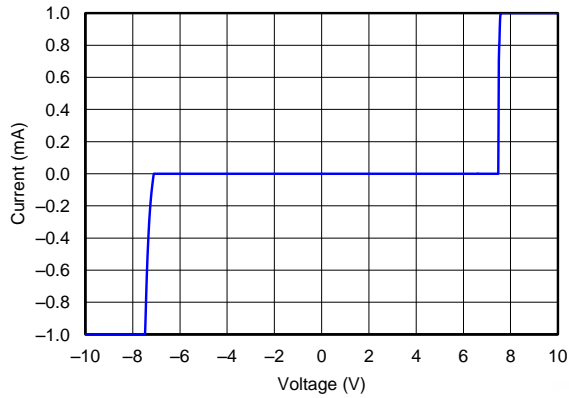

Figure 1. DC Voltage Sweep I-V Curve

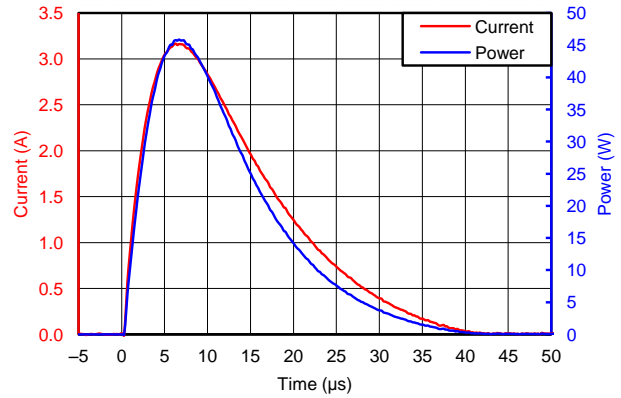

Figure 2. Surge Curve ($t_p = 8/20 \mu s$), Pin IO to GND

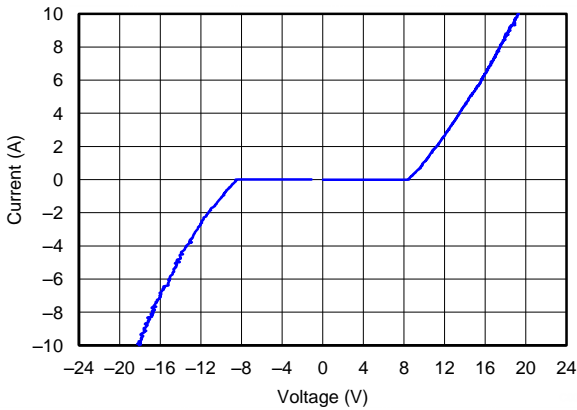

Figure 3. TLP Plot IO to GND

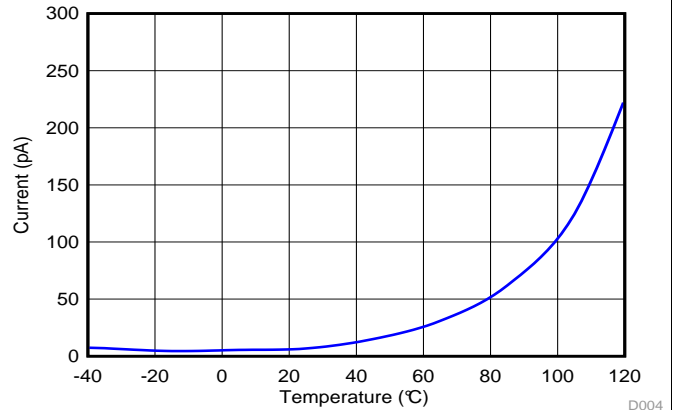

Figure 4. Leakage vs Temperature

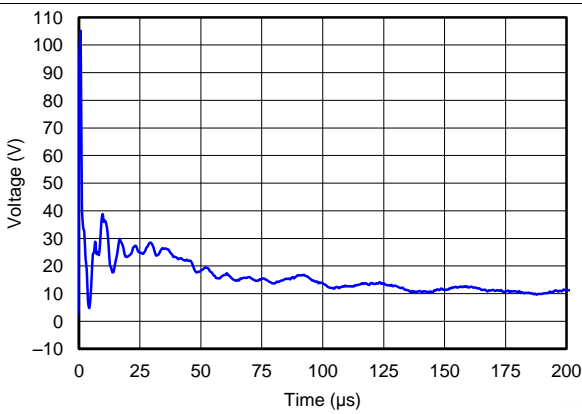

Figure 5. +8 kV IEC Waveform

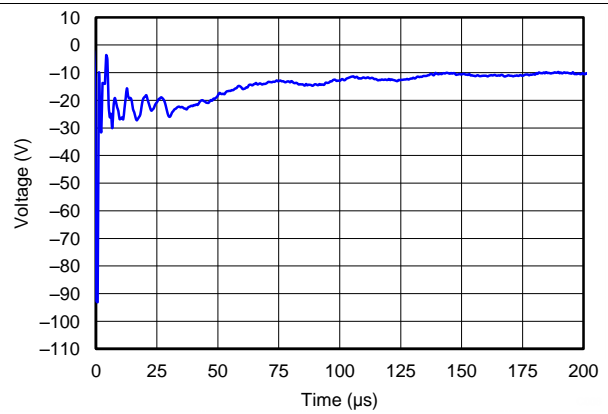
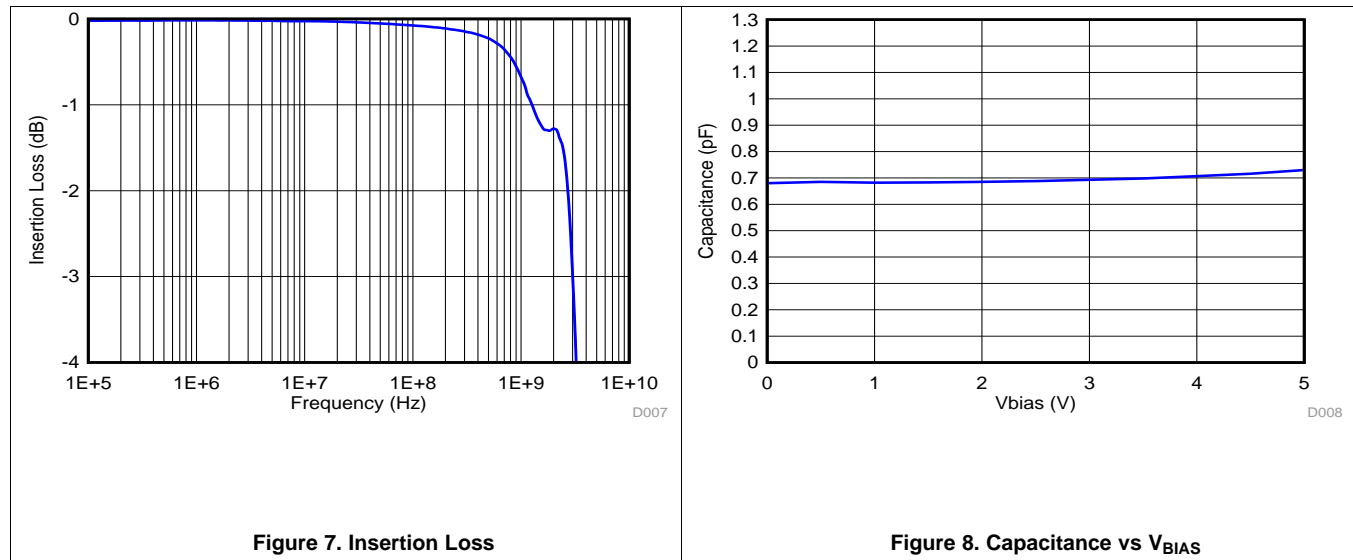

Figure 6. -8 kV IEC Waveform

Typical Characteristics (continued)



8 Detailed Description

8.1 Overview

The TPD4E1B06 is a 4-channel bi-directional Transient Voltage Suppressor (TVS) diode array. This device features ultra low leakage current (0.5 nA) for precision analog measurements. The ± 12 kV contact and ± 15 kV air gap ESD protection exceeds IEC 61000-4-2 level 4 requirements. The TPD4E1B06's 0.7 pF line capacitance makes it suitable for precision analog, USB2.0, Ethernet, SATA, LVDS, and 1394 interfaces.

8.2 Functional Block Diagram

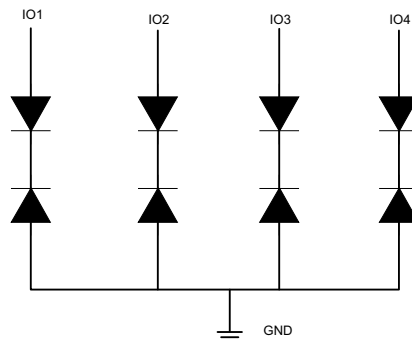

8.3 Feature Description

The TPD4E1B06 is a 4-channel bi-directional Transient Voltage Suppressor (TVS) diode array. This device features ultra low leakage current (0.5 nA) for precision analog measurements. The ± 12 kV contact and ± 15 kV air gap ESD protection exceeds IEC 61000-4-2 level 4 requirements. The TPD4E1B06's 0.7 pF line capacitance makes it suitable for precision analog, USB2.0, Ethernet, SATA, LVDS, and 1394 interfaces.

8.3.1 Ultra low Leakage Current 0.5 nA (Max)

TPD4E1B06 ultra-low leakage current supports long battery life and allows for precision analog measurements.

8.3.2 Transient Protection for 4 I/O Lines

The four I/O pins of TPD4E1B06 can withstand ESD events up to ± 12 kV contact and ± 15 kV air gap per IEC61000-4-2.

8.3.3 I/O Capacitance 0.7 pF (Typ)

TPD4E1B06 I/O pins present an ultra-low 0.7 pF capacitance to the protected signal lines, making it suitable for a wide range of applications.

8.3.4 Bi-directional TVS diode array

TPD4E1B06 diode array structure uses back to back diode topology to accommodate bi-directional signaling between -5.5 V and 5.5 V.

8.3.5 Low ESD Clamping Voltage

TPD4E1B06 clamps ESD events to a safe level to protect system components.

8.4 Device Functional Modes

TPD4E1B06 is a passive integrated circuit that activates whenever fast transient voltages above V_{BR} or below $-V_{BR}$ are present on the circuit being protected. During ESD events, voltages as high as ± 12 kV can be directed to ground via the internal diode network. Once the voltages on the protected line fall below the trigger levels of TPD4E1B06 (usually within 10's of nano-seconds) the device reverts to passive.

9 Application and Implementation

9.1 Application Information

TPD4E1B06 is a TVS diode array which is typically used to provide a path to ground for dissipating ESD events on hi-speed signal lines between a human interface connector and a system. As the current from ESD passes through the TVS diode, only a small voltage drop is present across the diode. This is the voltage presented to the protected IC. The low R_{DYN} of the triggered TVS holds this voltage, V_{CLAMP} , to a safe level to the protected IC.

9.2 Typical Application

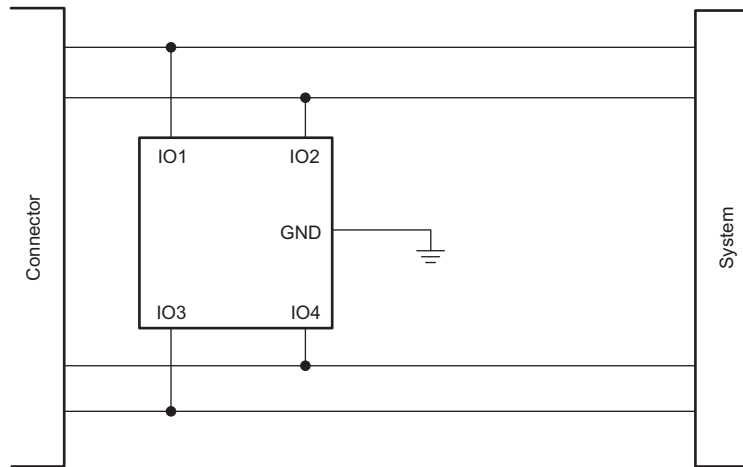

Figure 9. Protecting a Pair of Bi-Directional Differential Data Lines

The typical application of the TBD4E1B06 is to be placed in between the connector and the system. The low capacitance of the TBD4E1B06 gives flexibility in the end application, as it can be used on many different high speed interfaces.

9.2.1 Design Requirements

Table 1. Design Parameters

DESIGN PARAMETER	EXAMPLE VALUE
Signal range on IO1, IO2, IO3, IO4 Pins	–5.5 V to 5.5 V
Operating frequency	1.7 GHz

9.2.2 Detailed Design Procedure

The designer needs to know the following:

- Signal range on all the protected lines
- Operating frequency

9.2.2.1 Signal Range on IO1, IO2, IO3, and IO4 Pins

TPD4E1B06 has 4 protection channels for signal lines. Any I/O will support a signal range of –5.5 V to 5.5 V.

9.2.2.2 Operating Frequency

The 0.7 pF capacitance of each I/O channel supports data rates up to 3.4 Gbps.

9.2.3 Application Curves

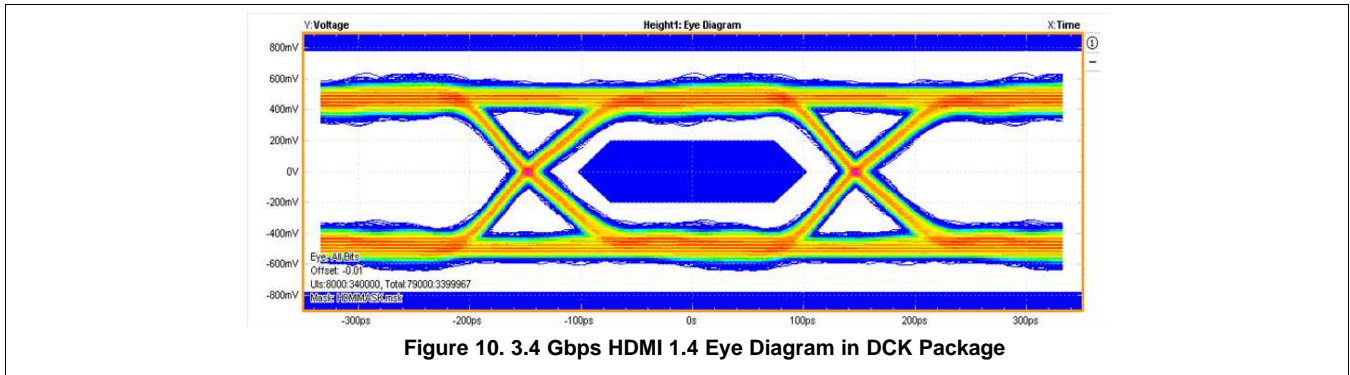

10 Layout

10.1 Layout Guidelines

- Place the device as close to the connector as possible.
 - EMI during an ESD event can couple from the trace being struck to other nearby unprotected traces, resulting in early system failures.
 - The PCB designer should minimize the possibility of EMI coupling by keeping any unprotected traces away from the protected traces which are between the TVS and the connector.
- Route the protected traces as straight as possible.
- Eliminate any sharp corners on the protected traces between the TVS and the connector by using rounded corners with the largest radii possible.
 - Electric fields tend to build up on corners, increasing EMI coupling.

10.2 Layout Examples

Figure 11 shows a layout example for the TPD4E1B06DCK. Pins 1 & 2 and 4 & 5 are routed differentially. Pin 3 is routed to the ground plane. Pin 6 does not have an internal connection in the device and does not need to be routed anywhere on the board. It is also acceptable to connect pin 6 to the ground plane.

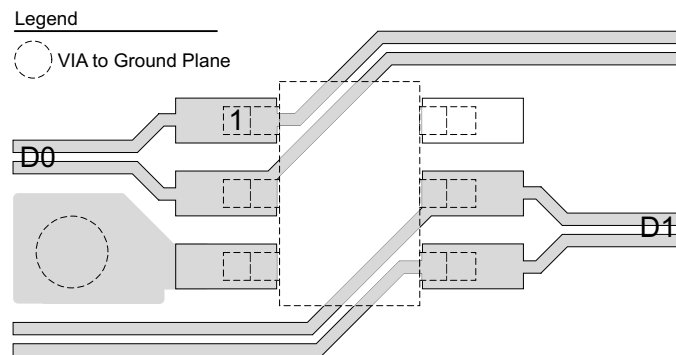

Figure 11. DCK Layout Example Showing Two Data Pairs, D0 and D1

Figure 12 shows a layout example for the TPD4E1B06DRL. Pins 1 & 6 and 3 & 4 are routed differentially. Pin 2 is routed to the ground plane. Pin 5 does not have an internal connection in the device and does not need to be routed anywhere on the board. It is also acceptable to connect pin 5 to the ground plane.

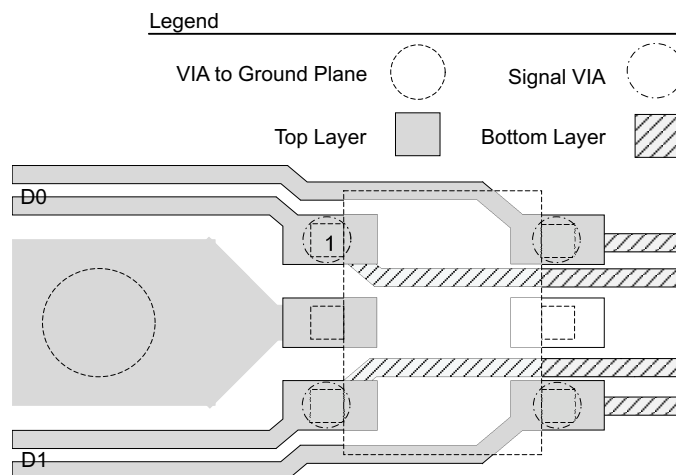

Figure 12. DRL Layout Example Showing Two Data Pairs, D0 and D1

11 Device and Documentation Support

11.1 Trademarks

All trademarks are the property of their respective owners.

11.2 Electrostatic Discharge Caution



This integrated circuit can be damaged by ESD. Texas Instruments recommends that all integrated circuits be handled with appropriate precautions. Failure to observe proper handling and installation procedures can cause damage.

ESD damage can range from subtle performance degradation to complete device failure. Precision integrated circuits may be more susceptible to damage because very small parametric changes could cause the device not to meet its published specifications.

11.3 Glossary

[SLYZ022](#) — *TI Glossary*.

This glossary lists and explains terms, acronyms, and definitions.

12 Mechanical, Packaging, and Orderable Information

The following pages include mechanical, packaging, and orderable information. This information is the most current data available for the designated devices. This data is subject to change without notice and revision of this document. For browser-based versions of this data sheet, refer to the left-hand navigation.

PACKAGING INFORMATION

Orderable Device	Status (1)	Package Type	Package Drawing	Pins	Package Qty	Eco Plan (2)	Lead/Ball Finish (6)	MSL Peak Temp (3)	Op Temp (°C)	Device Marking (4/5)	Samples
TPD4E1B06DCKR	ACTIVE	SC70	DCK	6	3000	Green (RoHS & no Sb/Br)	CU NIPDAU	Level-1-260C-UNLIM	-40 to 125	BYP	Samples
TPD4E1B06DRLR	ACTIVE	SOT-5X3	DRL	6	4000	Green (RoHS & no Sb/Br)	CU NIPDAU	Level-1-260C-UNLIM	-40 to 125	(BYG ~ BYH)	Samples
TPD4E1B06DRLT	PREVIEW	SOT-5X3	DRL	6	250	Green (RoHS & no Sb/Br)	CU NIPDAU	Level-1-260C-UNLIM	-40 to 125	(BYG ~ BYH)	

(1) The marketing status values are defined as follows:

ACTIVE: Product device recommended for new designs.

LIFEBUY: TI has announced that the device will be discontinued, and a lifetime-buy period is in effect.

NRND: Not recommended for new designs. Device is in production to support existing customers, but TI does not recommend using this part in a new design.

PREVIEW: Device has been announced but is not in production. Samples may or may not be available.

OBSELETE: TI has discontinued the production of the device.

(2) **RoHS:** TI defines "RoHS" to mean semiconductor products that are compliant with the current EU RoHS requirements for all 10 RoHS substances, including the requirement that RoHS substance do not exceed 0.1% by weight in homogeneous materials. Where designed to be soldered at high temperatures, "RoHS" products are suitable for use in specified lead-free processes. TI may reference these types of products as "Pb-Free".

RoHS Exempt: TI defines "RoHS Exempt" to mean products that contain lead but are compliant with EU RoHS pursuant to a specific EU RoHS exemption.

Green: TI defines "Green" to mean the content of Chlorine (Cl) and Bromine (Br) based flame retardants meet JS709B low halogen requirements of <=1000ppm threshold. Antimony trioxide based flame retardants must also meet the <=1000ppm threshold requirement.

(3) MSL, Peak Temp. - The Moisture Sensitivity Level rating according to the JEDEC industry standard classifications, and peak solder temperature.

(4) There may be additional marking, which relates to the logo, the lot trace code information, or the environmental category on the device.

(5) Multiple Device Markings will be inside parentheses. Only one Device Marking contained in parentheses and separated by a "~" will appear on a device. If a line is indented then it is a continuation of the previous line and the two combined represent the entire Device Marking for that device.

(6) Lead/Ball Finish - Orderable Devices may have multiple material finish options. Finish options are separated by a vertical ruled line. Lead/Ball Finish values may wrap to two lines if the finish value exceeds the maximum column width.

Important Information and Disclaimer:The information provided on this page represents TI's knowledge and belief as of the date that it is provided. TI bases its knowledge and belief on information provided by third parties, and makes no representation or warranty as to the accuracy of such information. Efforts are underway to better integrate information from third parties. TI has taken and continues to take reasonable steps to provide representative and accurate information but may not have conducted destructive testing or chemical analysis on incoming materials and chemicals. TI and TI suppliers consider certain information to be proprietary, and thus CAS numbers and other limited information may not be available for release.

In no event shall TI's liability arising out of such information exceed the total purchase price of the TI part(s) at issue in this document sold by TI to Customer on an annual basis.

TAPE AND REEL INFORMATION



QUADRANT ASSIGNMENTS FOR PIN 1 ORIENTATION IN TAPE



*All dimensions are nominal

Device	Package Type	Package Drawing	Pins	SPQ	Reel Diameter (mm)	Reel Width W1 (mm)	A0 (mm)	B0 (mm)	K0 (mm)	P1 (mm)	W (mm)	Pin1 Quadrant
TPD4E1B06DCKR	SC70	DCK	6	3000	178.0	8.4	2.4	2.5	1.2	4.0	8.0	Q3
TPD4E1B06DRLR	SOT-5X3	DRL	6	4000	180.0	9.5	1.78	1.78	0.69	4.0	8.0	Q3
TPD4E1B06DRLR	SOT-5X3	DRL	6	4000	180.0	8.4	1.98	1.78	0.69	4.0	8.0	Q3

TAPE AND REEL BOX DIMENSIONS

*All dimensions are nominal

Device	Package Type	Package Drawing	Pins	SPQ	Length (mm)	Width (mm)	Height (mm)
TPD4E1B06DCKR	SC70	DCK	6	3000	180.0	180.0	18.0
TPD4E1B06DRLR	SOT-5X3	DRL	6	4000	184.0	184.0	19.0
TPD4E1B06DRLR	SOT-5X3	DRL	6	4000	183.0	183.0	20.0

DRL (R-PDSO-N6)

PLASTIC SMALL OUTLINE

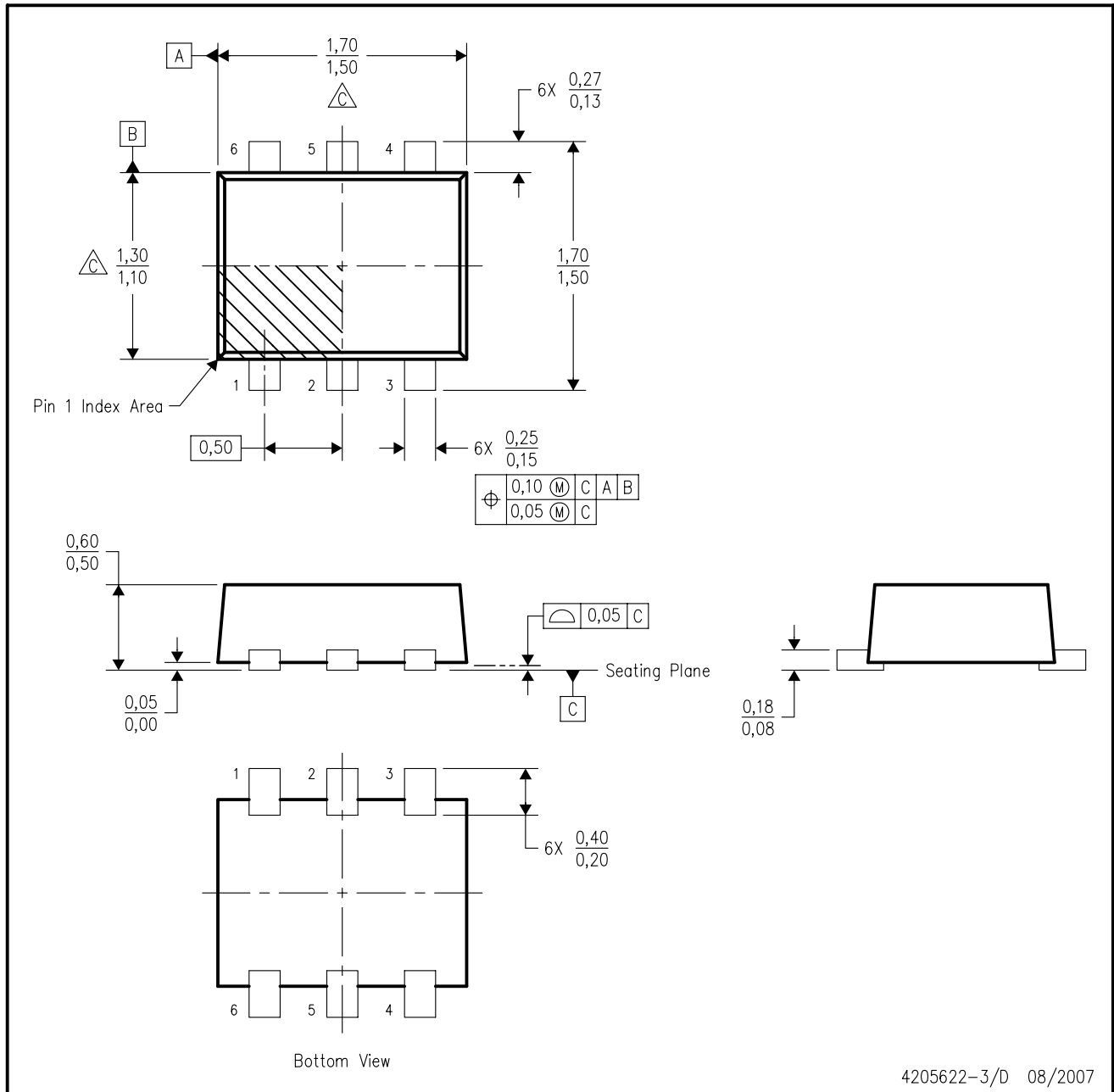

- NOTES:
- A. All linear dimensions are in millimeters. Dimensioning and tolerancing per ASME Y14.5M-1994.
 - B. This drawing is subject to change without notice.
 - C. Body dimensions do not include mold flash, interlead flash, protrusions, or gate burrs. Mold flash, interlead flash, protrusions, or gate burrs shall not exceed 0,15 per end or side.
 - D. JEDEC package registration is pending.

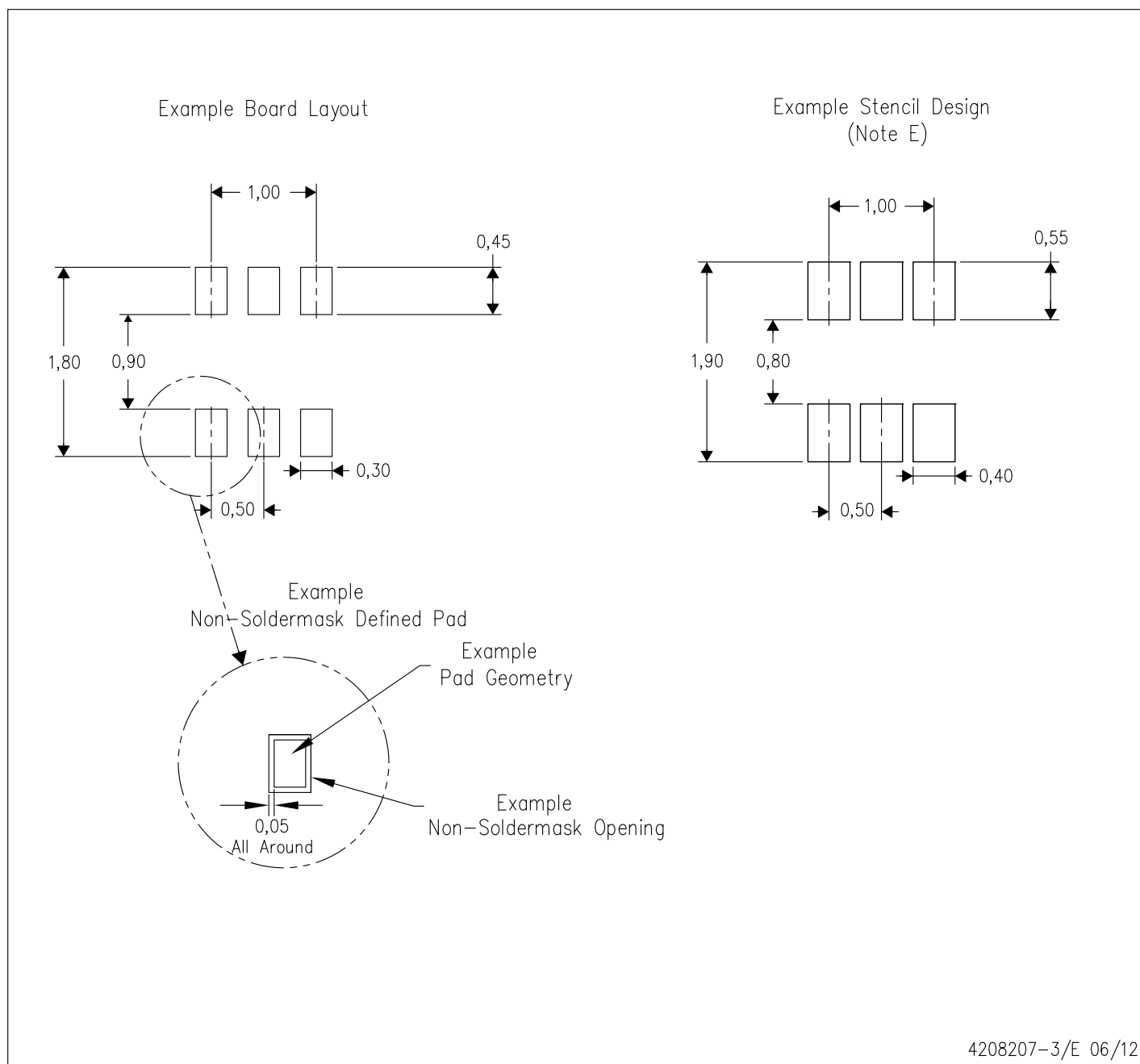

- NOTES:
- A. All linear dimensions are in millimeters.
 - B. This drawing is subject to change without notice.
 - C. Publication IPC-7351 is recommended for alternate designs.
 - D. Customers should contact their board fabrication site for minimum solder mask web tolerances between signal pads.
 - E. Maximum stencil thickness 0,127 mm (5 mils). All linear dimensions are in millimeters.
 - F. Laser cutting apertures with trapezoidal walls and also rounding corners will offer better paste release. Customers should contact their board assembly site for stencil design recommendations. Refer to IPC 7525 for stencil design considerations.
 - G. Side aperture dimensions over-print land for acceptable area ratio > 0.66. Customer may reduce side aperture dimensions if stencil manufacturing process allows for sufficient release at smaller opening.

DCK (R-PDSO-G6)

PLASTIC SMALL-OUTLINE PACKAGE



- NOTES:
- A. All linear dimensions are in millimeters.
 - B. This drawing is subject to change without notice.
 - C. Body dimensions do not include mold flash or protrusion. Mold flash and protrusion shall not exceed 0.15 per side.
 - D. Falls within JEDEC MO-203 variation AB.

DCK (R-PDSO-G6)

PLASTIC SMALL OUTLINE



- NOTES:
- All linear dimensions are in millimeters.
 - This drawing is subject to change without notice.
 - Customers should place a note on the circuit board fabrication drawing not to alter the center solder mask defined pad.
 - Publication IPC-7351 is recommended for alternate designs.
 - Laser cutting apertures with trapezoidal walls and also rounding corners will offer better paste release. Customers should contact their board assembly site for stencil design recommendations. Example stencil design based on a 50% volumetric metal load solder paste. Refer to IPC-7525 for other stencil recommendations.

IMPORTANT NOTICE

Texas Instruments Incorporated (TI) reserves the right to make corrections, enhancements, improvements and other changes to its semiconductor products and services per JESD46, latest issue, and to discontinue any product or service per JESD48, latest issue. Buyers should obtain the latest relevant information before placing orders and should verify that such information is current and complete.

TI's published terms of sale for semiconductor products (<http://www.ti.com/sc/docs/stdterms.htm>) apply to the sale of packaged integrated circuit products that TI has qualified and released to market. Additional terms may apply to the use or sale of other types of TI products and services.

Reproduction of significant portions of TI information in TI data sheets is permissible only if reproduction is without alteration and is accompanied by all associated warranties, conditions, limitations, and notices. TI is not responsible or liable for such reproduced documentation. Information of third parties may be subject to additional restrictions. Resale of TI products or services with statements different from or beyond the parameters stated by TI for that product or service voids all express and any implied warranties for the associated TI product or service and is an unfair and deceptive business practice. TI is not responsible or liable for any such statements.

Buyers and others who are developing systems that incorporate TI products (collectively, "Designers") understand and agree that Designers remain responsible for using their independent analysis, evaluation and judgment in designing their applications and that Designers have full and exclusive responsibility to assure the safety of Designers' applications and compliance of their applications (and of all TI products used in or for Designers' applications) with all applicable regulations, laws and other applicable requirements. Designer represents that, with respect to their applications, Designer has all the necessary expertise to create and implement safeguards that (1) anticipate dangerous consequences of failures, (2) monitor failures and their consequences, and (3) lessen the likelihood of failures that might cause harm and take appropriate actions. Designer agrees that prior to using or distributing any applications that include TI products, Designer will thoroughly test such applications and the functionality of such TI products as used in such applications.

TI's provision of technical, application or other design advice, quality characterization, reliability data or other services or information, including, but not limited to, reference designs and materials relating to evaluation modules, (collectively, "TI Resources") are intended to assist designers who are developing applications that incorporate TI products; by downloading, accessing or using TI Resources in any way, Designer (individually or, if Designer is acting on behalf of a company, Designer's company) agrees to use any particular TI Resource solely for this purpose and subject to the terms of this Notice.

TI's provision of TI Resources does not expand or otherwise alter TI's applicable published warranties or warranty disclaimers for TI products, and no additional obligations or liabilities arise from TI providing such TI Resources. TI reserves the right to make corrections, enhancements, improvements and other changes to its TI Resources. TI has not conducted any testing other than that specifically described in the published documentation for a particular TI Resource.

Designer is authorized to use, copy and modify any individual TI Resource only in connection with the development of applications that include the TI product(s) identified in such TI Resource. NO OTHER LICENSE, EXPRESS OR IMPLIED, BY ESTOPPEL OR OTHERWISE TO ANY OTHER TI INTELLECTUAL PROPERTY RIGHT, AND NO LICENSE TO ANY TECHNOLOGY OR INTELLECTUAL PROPERTY RIGHT OF TI OR ANY THIRD PARTY IS GRANTED HEREIN, including but not limited to any patent right, copyright, mask work right, or other intellectual property right relating to any combination, machine, or process in which TI products or services are used. Information regarding or referencing third-party products or services does not constitute a license to use such products or services, or a warranty or endorsement thereof. Use of TI Resources may require a license from a third party under the patents or other intellectual property of the third party, or a license from TI under the patents or other intellectual property of TI.

TI RESOURCES ARE PROVIDED "AS IS" AND WITH ALL FAULTS. TI DISCLAIMS ALL OTHER WARRANTIES OR REPRESENTATIONS, EXPRESS OR IMPLIED, REGARDING RESOURCES OR USE THEREOF, INCLUDING BUT NOT LIMITED TO ACCURACY OR COMPLETENESS, TITLE, ANY EPIDEMIC FAILURE WARRANTY AND ANY IMPLIED WARRANTIES OF MERCHANTABILITY, FITNESS FOR A PARTICULAR PURPOSE, AND NON-INFRINGEMENT OF ANY THIRD PARTY INTELLECTUAL PROPERTY RIGHTS. TI SHALL NOT BE LIABLE FOR AND SHALL NOT DEFEND OR INDEMNIFY DESIGNER AGAINST ANY CLAIM, INCLUDING BUT NOT LIMITED TO ANY INFRINGEMENT CLAIM THAT RELATES TO OR IS BASED ON ANY COMBINATION OF PRODUCTS EVEN IF DESCRIBED IN TI RESOURCES OR OTHERWISE. IN NO EVENT SHALL TI BE LIABLE FOR ANY ACTUAL, DIRECT, SPECIAL, COLLATERAL, INDIRECT, PUNITIVE, INCIDENTAL, CONSEQUENTIAL OR EXEMPLARY DAMAGES IN CONNECTION WITH OR ARISING OUT OF TI RESOURCES OR USE THEREOF, AND REGARDLESS OF WHETHER TI HAS BEEN ADVISED OF THE POSSIBILITY OF SUCH DAMAGES.

Unless TI has explicitly designated an individual product as meeting the requirements of a particular industry standard (e.g., ISO/TS 16949 and ISO 26262), TI is not responsible for any failure to meet such industry standard requirements.

Where TI specifically promotes products as facilitating functional safety or as compliant with industry functional safety standards, such products are intended to help enable customers to design and create their own applications that meet applicable functional safety standards and requirements. Using products in an application does not by itself establish any safety features in the application. Designers must ensure compliance with safety-related requirements and standards applicable to their applications. Designer may not use any TI products in life-critical medical equipment unless authorized officers of the parties have executed a special contract specifically governing such use. Life-critical medical equipment is medical equipment where failure of such equipment would cause serious bodily injury or death (e.g., life support, pacemakers, defibrillators, heart pumps, neurostimulators, and implantables). Such equipment includes, without limitation, all medical devices identified by the U.S. Food and Drug Administration as Class III devices and equivalent classifications outside the U.S.

TI may expressly designate certain products as completing a particular qualification (e.g., Q100, Military Grade, or Enhanced Product). Designers agree that it has the necessary expertise to select the product with the appropriate qualification designation for their applications and that proper product selection is at Designers' own risk. Designers are solely responsible for compliance with all legal and regulatory requirements in connection with such selection.

Designer will fully indemnify TI and its representatives against any damages, costs, losses, and/or liabilities arising out of Designer's non-compliance with the terms and provisions of this Notice.