

Click to
ORDER
samples

AM2DS-JZ



SIP7 Package

The AM2DS-JZ is a 2W SIP7 DC/DC converter that offers great cost savings thanks to an improved manufacturing process. It also features excellent reliability and performance while offering a standard input voltage range of 5-24VDC as well as an output voltage of 3.3-24V. This compact SIP7 design will surely benefit your new system design.

This new series offers great operating temperatures, from -40 to 105°C with full power up to 85°C. Also, an isolation of 1500 or 3000VDC for improved reliability and system safety as well as a great 3,500,000h MTBF come standard.

The AM2DS-JZ is perfect for instrumentation, industrial controls, industrial applications, communication and IoT applications.

Features

- High I/O Isolation of 1500/3000VDC
- Continuous Short circuit protection
- Operating Temp: -40 °C to +105 °C
- Industry standard SIP7 pin-out
- Efficiency up to 86%
- Unregulated output

Summary

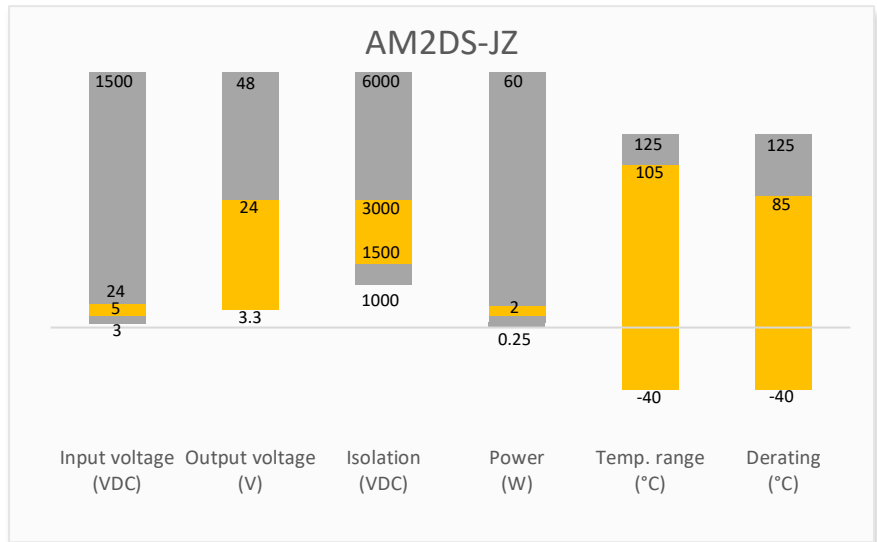

Training

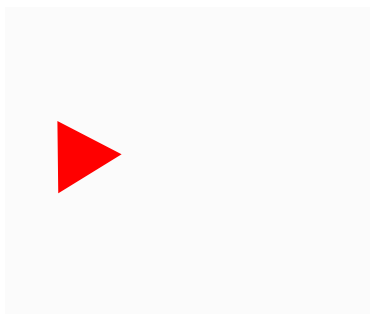

Product Training Video
(click to open)

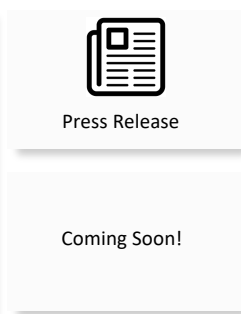

Application Notes

Applications



IoT



Industrial



Telecom



Portable Equipment

Models & Specifications



Single Output							
Model	Input Voltage (VDC)	Output Voltage (VDC)	Input Current Full No load typ. (mA)	Output Current max min (mA)*	Isolation (VDC)	Maximum capacitive Load (μF)	Efficiency Typ. (%)
AM2DS-0503SJZ	5 (4.5-5.5)	3.3	534 / 8	400 / 40	1500	2400	78
AM2DS-0505SJZ	5 (4.5-5.5)	5	477 / 8	400 / 40	1500	2400	84
AM2DS-0507SJZ	5 (4.5-5.5)	7.2	477 / 8	278 / 28	1500	1000	84
AM2DS-0509SJZ	5 (4.5-5.5)	9	471 / 8	222 / 22	1500	1000	85
AM2DS-0512SJZ	5 (4.5-5.5)	12	471 / 8	167 / 17	1500	560	85
AM2DS-0515SJZ	5 (4.5-5.5)	15	466 / 8	133 / 13	1500	560	86
AM2DS-0524SJZ	5 (4.5-5.5)	24	466 / 8	83 / 8	1500	220	86
AM2DS-1203SJZ	12 (10.8-13.2)	3.3	223 / 8	400 / 40	1500	2400	79
AM2DS-1205SJZ #	12 (10.8-13.2)	5	223 / 8	400 / 40	1500	2400	82
AM2DS-1209SJZ	12 (10.8-13.2)	9	223 / 8	222 / 22	1500	1000	82
AM2DS-1212SJZ #	12 (10.8-13.2)	12	223 / 8	167 / 17	1500	560	84
AM2DS-1215SJZ #	12 (10.8-13.2)	15	223 / 8	133 / 13	1500	560	85
AM2DS-1224SJZ #	12 (10.8-13.2)	24	223 / 8	83 / 8	1500	220	86
AM2DS-1505SJZ	15 (13.5-16.5)	5	167 / 8	400 / 40	1500	2400	80
AM2DS-1515SJZ	15 (13.5-16.5)	15	167 / 8	133 / 13	1500	560	81
AM2DS-1524SJZ	15 (13.5-16.5)	24	167 / 8	83 / 8	1500	220	81
AM2DS-2403SJZ	24 (21.6-26.4)	3.3	110 / 8	400 / 40	1500	2400	76
AM2DS-2405SJZ #	24 (21.6-26.4)	5	110 / 8	400 / 40	1500	2400	80
AM2DS-2409SJZ	24 (21.6-26.4)	9	110 / 8	222 / 22	1500	1000	81
AM2DS-2412SJZ #	24 (21.6-26.4)	12	110 / 8	167 / 17	1500	560	84
AM2DS-2415SJZ #	24 (21.6-26.4)	15	110 / 8	133 / 13	1500	560	86
AM2DS-2424SJZ #	24 (21.6-26.4)	24	110 / 8	83 / 8	1500	220	86
AM2DS-0503SH30JZ	5 (4.5-5.5)	3.3	534 / 8	400 / 40	3000	2400	78
AM2DS-0505SH30JZ	5 (4.5-5.5)	5	477 / 8	400 / 40	3000	2400	84
AM2DS-0507SH30JZ	5 (4.5-5.5)	7.2	477 / 8	278 / 28	3000	1000	84
AM2DS-0509SH30JZ	5 (4.5-5.5)	9	471 / 8	222 / 22	3000	1000	85
AM2DS-0512SH30JZ	5 (4.5-5.5)	12	471 / 8	167 / 17	3000	560	85
AM2DS-0515SH30JZ	5 (4.5-5.5)	15	466 / 8	133 / 13	3000	560	86
AM2DS-0524SH30JZ	5 (4.5-5.5)	24	466 / 8	83 / 8	3000	220	86
AM2DS-1205SH30JZ #	12 (10.8-13.2)	5	208 / 8	400 / 40	3000	2400	82
AM2DS-1206SH30JZ	12 (10.8-13.2)	6.4	208 / 8	312 / 31	3000	1000	82
AM2DS-1209SH30JZ	12 (10.8-13.2)	9	208 / 8	222 / 22	3000	1000	82
AM2DS-1212SH30JZ #	12 (10.8-13.2)	12	208 / 8	167 / 17	3000	560	84
AM2DS-1215SH30JZ #	12 (10.8-13.2)	15	208 / 8	133 / 13	3000	560	85
AM2DS-1224SH30JZ #	12 (10.8-13.2)	24	208 / 8	83 / 8	3000	220	86
AM2DS-1505SH30JZ	15 (13.5-16.5)	5	167 / 8	400 / 40	3000	2400	80
AM2DS-1509SH30JZ	15 (13.5-16.5)	9	167 / 8	222 / 22	3000	1000	80
AM2DS-1512SH30JZ	15 (13.5-16.5)	12	167 / 8	167 / 17	3000	560	81
AM2DS-1515SH30JZ	15 (13.5-16.5)	15	167 / 8	133 / 13	3000	560	81
AM2DS-1524SH30JZ	15 (13.5-16.5)	24	167 / 8	83 / 8	3000	220	81
AM2DS-2403SH30JZ	24 (21.6-26.4)	3.3	104 / 8	400 / 40	3000	2400	76
AM2DS-2405SH30JZ #	24 (21.6-26.4)	5	104 / 8	400 / 40	3000	2400	80
AM2DS-2407SH30JZ	24 (21.6-26.4)	7.2	104 / 8	278 / 27	3000	1000	80

AM2DS-2409SH30JZ	24 (21.6-26.4)	9	104 / 8	222 / 22	3000	1000	81
AM2DS-2412SH30JZ #	24 (21.6-26.4)	12	104 / 8	167 / 17	3000	560	84
AM2DS-2415SH30JZ #	24 (21.6-26.4)	15	104 / 8	133 / 13	3000	560	86
AM2DS-2418SH30JZ	24 (21.6-26.4)	18	104 / 8	111 / 11	3000	220	86
AM2DS-2424SH30JZ #	24 (21.6-26.4)	24	104 / 8	83 / 8	3000	220	86

* Performance will be degraded if the load is not within the output current range.

Dual Output

Model	Input Voltage (VDC)	Output Voltage (VDC)	Input Current Full No load typ. (mA)	Output Current max min (mA)*	Isolation (VDC)	Maximum capacitive Load (μF)	Efficiency Typ. (%)
AM2DS-0503DJZ	5 (4.5-5.5)	±3.3	534 / 8	±303 / ±30	1500	±1200	75
AM2DS-0505DJZ	5 (4.5-5.5)	±5	477 / 8	±200 / ±20	1500	±1200	84
AM2DS-0509DJZ	5 (4.5-5.5)	±9	471 / 8	±111 / ±11	1500	±470	85
AM2DS-0512DJZ	5 (4.5-5.5)	±12	471 / 8	±83 / ±8	1500	±220	85
AM2DS-0515DJZ	5 (4.5-5.5)	±15	466 / 8	±67 / ±7	1500	±220	86
AM2DS-0524DJZ	5 (4.5-5.5)	±24	466 / 8	±42 / ±4	1500	±100	86
AM2DS-1203DJZ #	12 (10.8-13.2)	±3.3	223 / 8	±303 / ±30	1500	±1200	75
AM2DS-1205DJZ #	12 (10.8-13.2)	±5	223 / 8	±200 / ±20	1500	±1200	80
AM2DS-1207DJZ	12 (10.8-13.2)	±7.2	223 / 8	±139 / ±13	1500	±470	80
AM2DS-1209DJZ	12 (10.8-13.2)	±9	223 / 8	±111 / ±11	1500	±470	82
AM2DS-1212DJZ #	12 (10.8-13.2)	±12	223 / 8	±83 / ±8	1500	±220	83
AM2DS-1215DJZ #	12 (10.8-13.2)	±15	223 / 8	±67 / ±7	1500	±220	83
AM2DS-1224DJZ	12 (10.8-13.2)	±24	223 / 8	±42 / ±4	1500	±100	83
AM2DS-1505DJZ	15 (13.5-16.5)	±5	167 / 8	±200 / ±20	1500	±1200	80
AM2DS-1515DJZ	15 (13.5-16.5)	±15	167 / 8	±67 / ±7	1500	±220	82
AM2DS-2403DJZ	24 (21.6-26.4)	±3.3	110 / 8	±303 / ±30	1500	±1200	76
AM2DS-2405DJZ #	24 (21.6-26.4)	±5	110 / 8	±200 / ±20	1500	±1200	80
AM2DS-2407DJZ	24 (21.6-26.4)	±7.2	110 / 8	±139 / ±13	1500	±470	80
AM2DS-2409DJZ	24 (21.6-26.4)	±9	110 / 8	±111 / ±11	1500	±470	81
AM2DS-2412DJZ #	24 (21.6-26.4)	±12	110 / 8	±83 / ±8	1500	±220	83
AM2DS-2415DJZ #	24 (21.6-26.4)	±15	110 / 8	±67 / ±7	1500	±220	83
AM2DS-2424DJZ	24 (21.6-26.4)	±24	110 / 8	±42 / ±4	1500	±100	83
AM2DS-0503DH30JZ	5 (4.5-5.5)	±3.3	534 / 8	±303 / ±30	3000	±1200	75
AM2DS-0505DH30JZ	5 (4.5-5.5)	±5	477 / 8	±200 / ±20	3000	±1200	84
AM2DS-0509DH30JZ	5 (4.5-5.5)	±9	471 / 8	±111 / ±11	3000	±470	85
AM2DS-0512DH30JZ	5 (4.5-5.5)	±12	471 / 8	±83 / ±8	3000	±220	85
AM2DS-0515DH30JZ	5 (4.5-5.5)	±15	466 / 8	±67 / ±7	3000	±220	86
AM2DS-0524DH30JZ	5 (4.5-5.5)	±24	466 / 8	±42 / ±4	3000	±100	86
AM2DS-1203DH30JZ #	12 (10.8-13.2)	±3.3	208 / 8	±303 / ±30	3000	±1200	75
AM2DS-1205DH30JZ #	12 (10.8-13.2)	±5	208 / 8	±200 / ±20	3000	±1200	80
AM2DS-1207DH30JZ	12 (10.8-13.2)	±7.2	208 / 8	±139 / ±13	3000	±470	80
AM2DS-1209DH30JZ	12 (10.8-13.2)	±9	208 / 8	±111 / ±11	3000	±470	82
AM2DS-1212DH30JZ #	12 (10.8-13.2)	±12	208 / 8	±83 / ±8	3000	±220	83
AM2DS-1215DH30JZ #	12 (10.8-13.2)	±15	208 / 8	±67 / ±7	3000	±220	83
AM2DS-1224DH30JZ	12 (10.8-13.2)	±24	208 / 8	±42 / ±4	3000	±100	83
AM2DS-1505DH30JZ	15 (13.5-16.5)	±5	167 / 8	±200 / ±20	3000	±1200	80
AM2DS-1515DH30JZ	15 (13.5-16.5)	±15	167 / 8	±67 / ±7	3000	±220	82
AM2DS-2403DH30JZ	24 (21.6-26.4)	±3.3	104 / 8	±303 / ±30	3000	±1200	76
AM2DS-2405DH30JZ #	24 (21.6-26.4)	±5	104 / 8	±200 / ±20	3000	±1200	80

AM2DS-2407DH30JZ	24 (21.6-26.4)	±7.2	104 / 8	±139 / ±13	3000	±470	80
AM2DS-2409DH30JZ	24 (21.6-26.4)	±9	104 / 8	±111 / ±11	3000	±470	81
AM2DS-2412DH30JZ #	24 (21.6-26.4)	±12	104 / 8	±83 / ±8	3000	±220	83
AM2DS-2415DH30JZ #	24 (21.6-26.4)	±15	104 / 8	±67 / ±7	3000	±220	83
AM2DS-2424DH30JZ	24 (21.6-26.4)	±24	104 / 8	±42 / ±4	3000	±100	83

* Performance will be degraded if the load is not within the output current range.

Input Specification				
Parameters	Conditions	Typical	Maximum	Units
Filter	Capacitor			
Absolute maximum rating	Maximum duration 1s, 5Vin	> -0.7	9	VDC
	Maximum duration 1s, 12Vin	> -0.7	18	VDC
	Maximum duration 1s, 15Vin	> -0.7	21	VDC
	Maximum duration 1s, 24Vin	> -0.7	30	VDC
Input reflected ripple current		15		mA

Isolation Specification				
Parameters	Conditions	Typical	Maximum	Units
Tested I/O voltage	60 sec, leakage ≤ 1mA	>1500		VDC
	60 sec, leakage ≤ 1mA for H30 models	>3000		VDC
Resistance	500VDC	>1000		MΩ
Capacitance	100kHz/0.1V	20		pF

Output Specification				
Parameters	Conditions	Typical	Maximum	Units
Voltage accuracy	See output voltage tolerance	10	16	%
Line regulation	Per 1% Vin change, 3.3Vout models		1.5	%
	Per 1% Vin change, other models		1.2	%
Load regulation	10-100% load, 5Vin, 3.3Vout models		20	%
	10-100% load, 5Vin, 5/7.2Vout models		15	%
	10-100% load, 5Vin, other models		10	%
	10-100% load, 12/15/24Vin, 3.3Vout models	15		%
	10-100% load, 12/15/24Vin, 5Vout models	7		%
	10-100% load, 12/15/24Vin, 6.4Vout models	10		%
	10-100% load, 12/15/24Vin, 7.2Vout models	6		%
	10-100% load, 12/15/24Vin, 9/12Vout models	5		%
	10-100% load, 12/15/24Vin, 15Vout models	4		%
	10-100% load, 12/15/24Vin, 18/24Vout models	3		%
Ripple & Noise*	5Vin models	75	200	mV pk-pk
	Other models	75	180	mV pk-pk
Temperature coefficient		±0.02		%/°C

* Ripple and Noise are measured at 20MHz bandwidth. Please refer to the application note for specific details.

General Specifications				
Parameters	Conditions	Typical	Maximum	Units
Switching frequency	Full load, nominal input, 5Vin models	220		KHz
	Full load, nominal input, other models	260		KHz
Short circuit protection	Continuous, Auto recovery			
Operating temperature	With derating	-40 to +105		°C
Storage temperature		-55 to +125		°C
Case temperature rise	Ta = 25°C, 12/15/24Vin, 1500V isolation models	15		°C
	Ta = 25°C, other models	25		°C
Manual soldering temperature	1.5mm away from case, duration ≤ 10sec		300	°C
Cooling	Free air convection			
Humidity	Non-condensing	>5	95	% RH
Vibration	10-150Hz, 5G, 0.75mm, along all axis			
Case material	Black plastic (flammability to UL 94V-0)			
Weight		2.4		g
Dimensions (L x W x H)	0.77 x 0.28 x 0.40 inches (19.65 x 7.05 x 10.16 mm)			
MTBF	3 500 000 hrs (MIL-HDBK -217F, t=+25°C) / Full Load			
NOTE: All specifications in this datasheet are measured at an ambient temperature of 25°C, humidity<75%, nominal input voltage and at rated output load unless otherwise specified.				

Safety Specifications		
Parameters		
Agency approvals	cULus UL 62368-1 (For models marked with # only)	
Standards	Information technology Equipment	Design to meet IEC/EN/UL62368
	EMC - Conducted and radiated emission	CISPR32 / EN55032, class B with the recommended EMI circuit
	Electrostatic Discharge Immunity	IEC 61000-4-2 Air ±8KV, Contact ±6KV, Criteria B

Derating

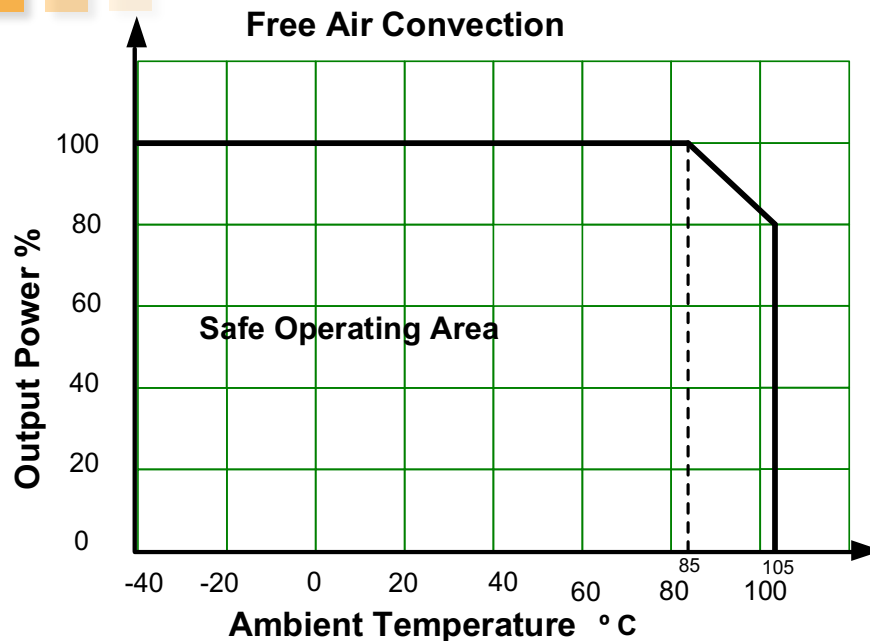

Output voltage tolerance

5Vin, 3.3Vout models

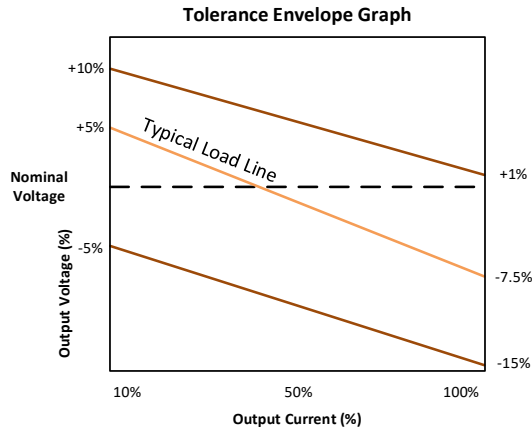

5Vin, other output models
12/15/24Vin, 5/7.2Vout models

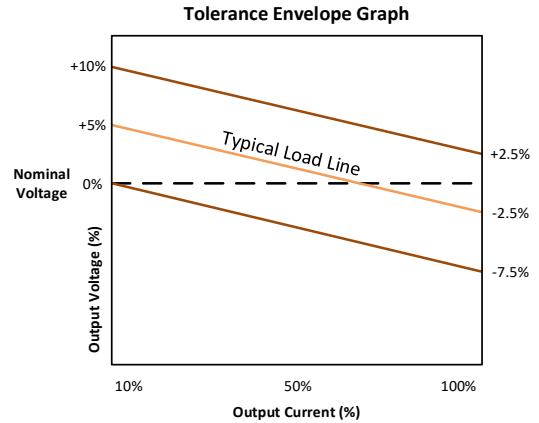

12/15/24Vin, 3.3Vout models

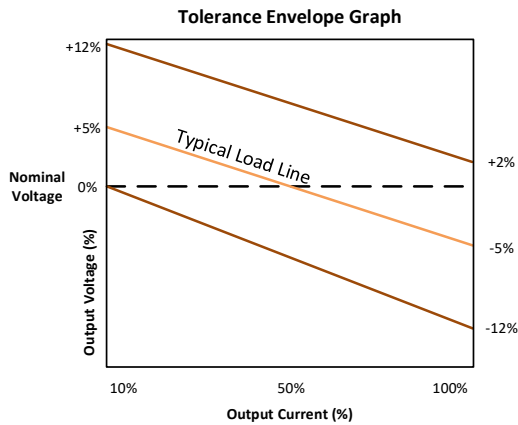

12/15/24Vin, 5/6.4/7.2Vout models

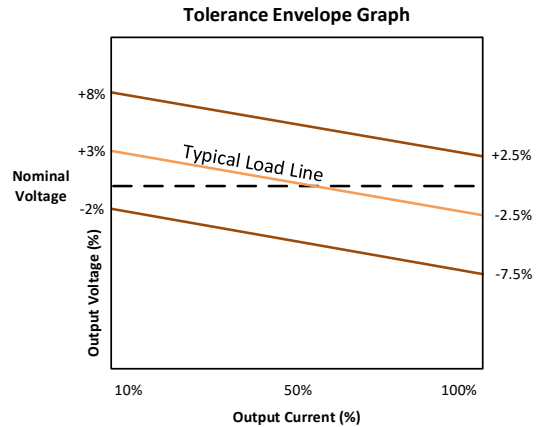

12/15/24Vin, other output models

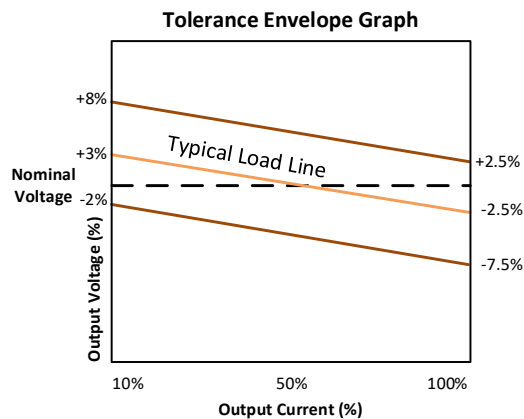

Typical application circuit

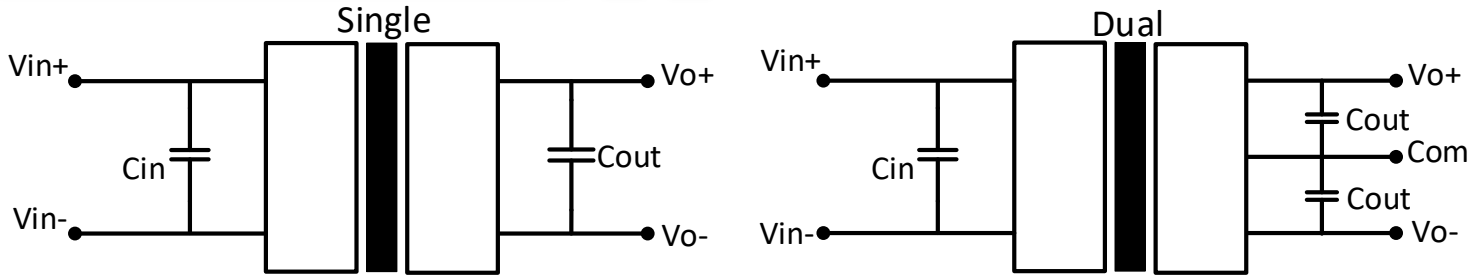

Vin	Cin	Single output models		Dual output models	
		Vout	Cout	Vout	Cout
5	10 μ F/16V	3.3V	10 μ F/16V	\pm 3.3V	4.7 μ F/16V
12	2.2 μ F/25V	5V	10 μ F/16V	\pm 5V	4.7 μ F/16V
15	2.2 μ F/25V	6.4V	4.7 μ F/16V	\pm 7.2V	2.2 μ F/25V
24	1 μ F/50V	7.2V (5Vin series)	10 μ F/16V	\pm 9V (5Vin series)	1 μ F/25V
-	-	7.2V (other series)	2.2 μ F/25V	\pm 9V (other series)	2.2 μ F/25V
-	-	9V	2.2 μ F/25V	\pm 12V	1 μ F/25V
-	-	12V	2.2 μ F/25V	\pm 15V (5Vin series)	0.47 μ F/25V
-	-	15V	1 μ F/25V	\pm 15V (other series)	1 μ F/25V
-	-	18V	1 μ F/50V	\pm 24V	0.47 μ F/50V
-	-	24V	1 μ F/50V	-	-

Recommended EMI circuit

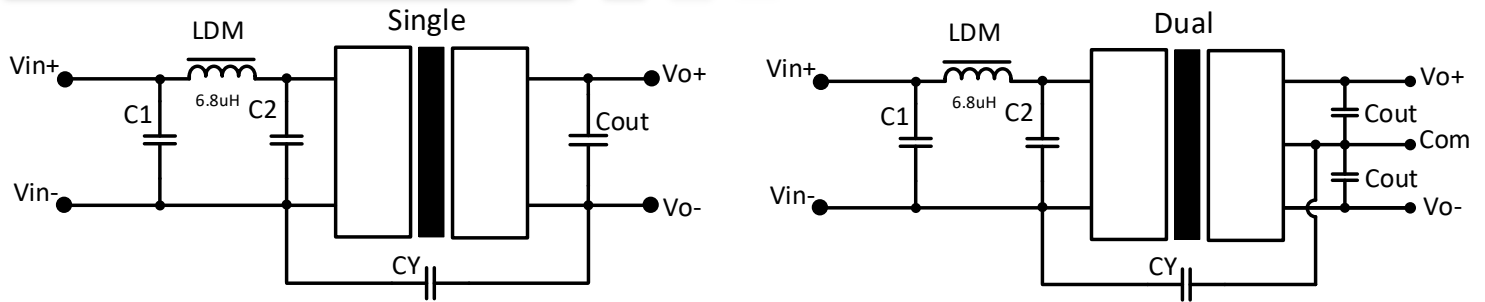

Vin	C1/C2	Vout	CY		Cout
			1500VDC isolation	3000VDC isolation	
5V	4.7 μ F/16V	All output	270pF/2kVdc	270pF/4kVdc	Refer to Cout in typical circuit
12V/15V/24V	4.7 μ F/50V	All output	270pF/2kVdc	270pF/3kVdc	Refer to Cout in typical circuit

Dimensions

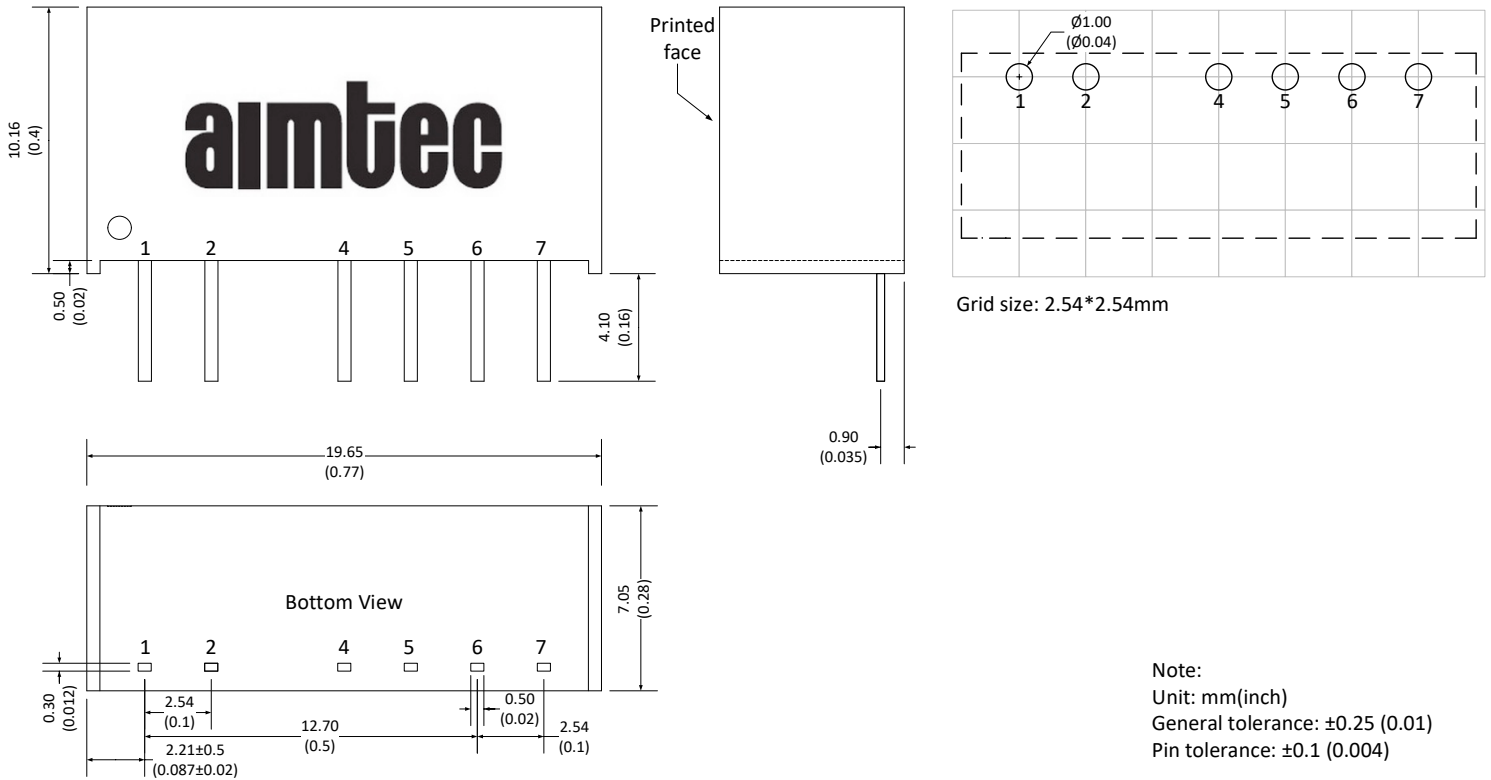

Pin Out Specifications

Pin	1.5KV isolation Single output	1.5KV isolation Dual output	3KV isolation Single output	3KV isolation Dual output
1	+V Input	+V Input	+V Input	+V Input
2	-V Input	-V Input	-V Input	-V Input
4	-V Output	-V Output	No pin	No pin
5	No pin	Com	-V Output	-V Output
6	+V Output	+V Output	No pin	Com
7	No pin	No pin	+V Output	+V Output

NOTE: 1. Datasheets are updated as needed and as such, specifications are subject to change without notice. Once printed or downloaded, datasheets are no longer controlled by Aimtec; refer to www.aimtec.com for the most current product specifications. **2.** Product labels shown, including safety agency certifications on labels, may vary based on the date manufactured. **3.** Mechanical drawings and specifications are for reference only. **4.** All specifications are measured at an ambient temperature of 25°C, humidity < 75%, nominal input voltage and at rated output load unless otherwise specified. **5.** Aimtec may not have conducted destructive testing or chemical analysis on all internal components and chemicals at the time of publishing this document. CAS numbers and other limited information are considered proprietary and may not be available for release. **6.** This product is not designed for use in critical life support systems, equipment used in hazardous environments, nuclear control systems or other such applications which necessitate specific safety and regulatory standards other than the ones listed in this datasheet. **7.** Warranty is in accordance with Aimtec's standard Terms of Sale available at www.aimtec.com.