

安装说明 (Installation Instructions)

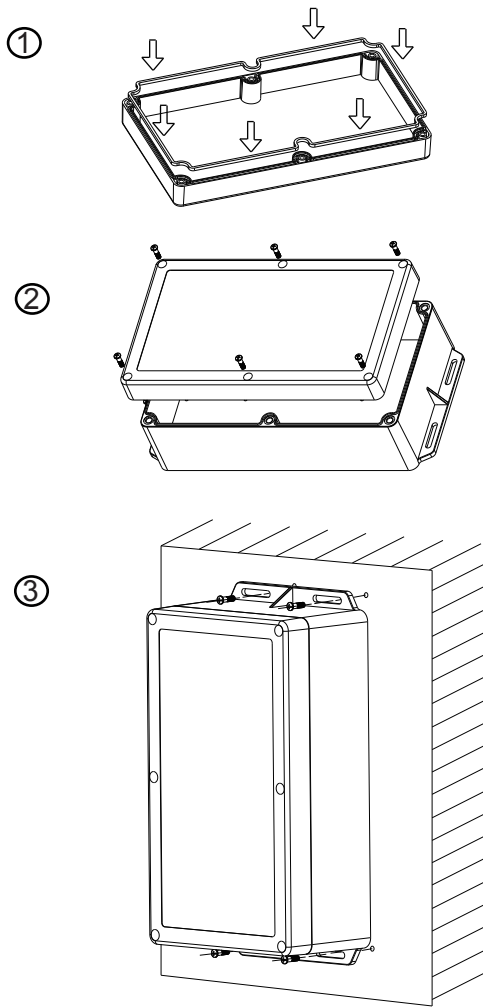

型号Code:11-181
 尺寸Size:289x152x90mm
 防护等级ProtectionClass:IP65

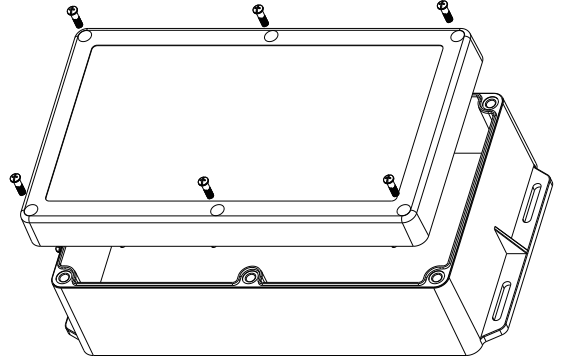

宁波三和壳体公司
 NINGBO SANHE ENCLOSURE CORPORATION

<http://www.china-mould.com>

