



Your Power Partner

## Series AM2F-Z

### 2 Watt | DC-DC Converter



#### FEATURES:

- RoHS compliant
- 12 Pin SIP Package
- Low ripple and noise
- High efficiency up to 72%
- Operating temperature -25°C to + 85°C
- Input / Output Isolation 1000, 3000 or 5200VDC
- Continuous Short Circuit Protection



#### Models

##### Single output

Model	Input Voltage (V)	Output Voltage (V)	Output Current Max (mA)	Capacitive Load, Max (µF)	Input Current Full   No Load (mA)		Isolation	Efficiency (%)
AM2F-0503SZ	4.5-5.5	3.3	500	330	559	68	1000	59
AM2F-0505SZ	4.5-5.5	5	400	330	588	45	1000	68
AM2F-0507SZ	4.5-5.5	7.2	278	330	625	90	1000	64
AM2F-0509SZ	4.5-5.5	9	222	330	563	75	1000	71
AM2F-0512SZ	4.5-5.5	12	167	330	597	80	1000	67
AM2F-0515SZ	4.5-5.5	15	134	330	571	95	1000	70
AM2F-0518SZ	4.5-5.5	18	111	330	580	95	1000	69
AM2F-0524SZ	4.5-5.5	24	83	330	597	76	1000	67
AM2F-1203SZ	10.8-13.2	3.3	500	330	250	30	1000	55
AM2F-1205SZ	10.8-13.2	5	400	330	249	20	1000	67
AM2F-1207SZ	10.8-13.2	7.2	278	330	253	30	1000	66
AM2F-1209SZ	10.8-13.2	9	222	330	253	45	1000	66
AM2F-1212SZ	10.8-13.2	12	167	330	249	45	1000	67
AM2F-1215SZ	10.8-13.2	15	134	330	245	45	1000	68
AM2F-1218SZ	10.8-13.2	18	111	330	256	50	1000	65
AM2F-1224SZ	10.8-13.2	24	83	330	231	35	1000	72
AM2F-2403SZ	21.6-26.4	3.3	500	330	127	25	1000	54
AM2F-2405SZ	21.6-26.4	5	400	330	132	25	1000	63
AM2F-2407SZ	21.6-26.4	7.2	278	330	123	22	1000	68
AM2F-2409SZ	21.6-26.4	9	222	330	117	20	1000	71
AM2F-2412SZ	21.6-26.4	12	167	330	119	20	1000	70
AM2F-2415SZ	21.6-26.4	15	134	330	124	25	1000	67
AM2F-2418SZ	21.6-26.4	18	111	330	117	20	1000	71
AM2F-2424SZ	21.6-26.4	24	83	330	116	20	1000	72
<b>Isolation 3000VDC</b>								
AM2F-0503SH30Z	4.5-5.5	3.3	500	330	559	68	3000	59
AM2F-0505SH30Z	4.5-5.5	5	400	330	588	45	3000	68
AM2F-0507SH30Z	4.5-5.5	7.2	278	330	625	90	3000	64
AM2F-0509SH30Z	4.5-5.5	9	222	330	563	75	3000	71
AM2F-0512SH30Z	4.5-5.5	12	167	330	597	80	3000	67
AM2F-0515SH30Z	4.5-5.5	15	134	330	571	95	3000	70
AM2F-0518SH30Z	4.5-5.5	18	111	330	580	95	3000	69
AM2F-0524SH30Z	4.5-5.5	24	83	330	597	76	3000	67
AM2F-1203SH30Z	10.8-13.2	3.3	500	330	250	30	3000	55
AM2F-1205SH30Z	10.8-13.2	5	400	330	249	20	3000	67
AM2F-1207SH30Z	10.8-13.2	7.2	278	330	253	30	3000	66
AM2F-1209SH30Z	10.8-13.2	9	222	330	253	45	3000	66
AM2F-1212SH30Z	10.8-13.2	12	167	330	249	45	3000	67
AM2F-1215SH30Z	10.8-13.2	15	134	330	245	45	3000	68
AM2F-1218SH30Z	10.8-13.2	18	111	330	256	50	3000	65
AM2F-1224SH52Z	10.8-13.2	24	83	330	231	35	3000	72
AM2F-2403SH30Z	21.6-26.4	3.3	500	330	127	25	3000	54
AM2F-2405SH30Z	21.6-26.4	5	400	330	132	25	3000	63
AM2F-2407SH30Z	21.6-26.4	7.2	278	330	123	22	3000	68
AM2F-2409SH30Z	21.6-26.4	9	222	330	117	20	3000	71
AM2F-2412SH30Z	21.6-26.4	12	167	330	119	20	3000	70

**Models**  
**Single output (continued)**

Model	Input Voltage (V)	Output Voltage (V)	Output Current Max (mA)	Capacitive Load, Max (µF)	Input Current Full   No Load (mA)		Isolation	Efficiency (%)
AM2F-2415SH30Z	21.6-26.4	15	134	330	124	25	3000	67
AM2F-2418SH30Z	21.6-26.4	18	111	330	117	20	3000	71
AM2F-2424SH30Z	21.6-26.4	24	83	330	116	20	3000	72
AM2F-0503SH52Z	4.5-5.5	3.3	500	330	559	68	5200	59
AM2F-0505SH52Z	4.5-5.5	5	400	330	588	45	5200	68
AM2F-0507SH52Z	4.5-5.5	7.2	278	330	625	90	5200	64
AM2F-0509SH52Z	4.5-5.5	9	222	330	563	75	5200	71
AM2F-0512SH52Z	4.5-5.5	12	167	330	597	80	5200	67
AM2F-0515SH52Z	4.5-5.5	15	134	330	571	95	5200	70
AM2F-0518SH52Z	4.5-5.5	18	111	330	580	95	5200	69
AM2F-0524SH52Z	4.5-5.5	24	83	330	597	76	5200	67
AM2F-1203SH52Z	10.8-13.2	3.3	500	330	250	30	5200	55
AM2F-1205SH52Z	10.8-13.2	5	400	330	249	20	5200	67
AM2F-1207SH52Z	10.8-13.2	7.2	278	330	253	30	5200	66
AM2F-1209SH52Z	10.8-13.2	9	222	330	253	45	5200	66
AM2F-1212SH52Z	10.8-13.2	12	167	330	249	45	5200	67
AM2F-1215SH52Z	10.8-13.2	15	134	330	245	45	5200	68
AM2F-1218SH52Z	10.8-13.2	18	111	330	256	50	5200	65
AM2F-1224SH52Z	10.8-13.2	24	83	330	231	35	5200	72
AM2F-2403SH52Z	21.6-26.4	3.3	500	330	127	25	5200	54
AM2F-2405SH52Z	21.6-26.4	5	400	330	132	25	5200	63
AM2F-2407SH52Z	21.6-26.4	7.2	278	330	123	22	5200	68
AM2F-2409SH52Z	21.6-26.4	9	222	330	117	20	5200	71
AM2F-2412SH52Z	21.6-26.4	12	167	330	119	20	5200	70
AM2F-2415SH52Z	21.6-26.4	15	134	330	124	25	5200	67
AM2F-2418SH52Z	21.6-26.4	18	111	330	117	20	5200	71
AM2F-2424SH52Z	21.6-26.4	24	83	330	116	20	5200	72

**Input Specifications**

Parameters	Nominal	Typical	Maximum	Units
Voltage range	5	4.5-5.5		VDC
	12	10.8-13.2		
	24	21.6-25.4		
Filter	Capacitor			
Absolute Maximum Rating	5 Vin	0-7		VDC
	12 Vin	0-15		
	24 Vin	0-28		
Peak Input Voltage time		100		ms
Input Reflected Ripple Current		20		mA p-p

**Isolation Specifications**

Parameters	Conditions	Typical	Rated	Units
Tested I/O voltage	60 sec		1000, 3000, or 5200	VDC
Resistance		> 1000		MOhm
Capacitance		60		pF

**Output Specifications**

Parameters	Conditions	Typical	Maximum	Units
Voltage accuracy			±2	%
Short Circuit protection		Continuous		
Short Circuit restart		Auto-recovery		
Line voltage regulation			±0.5	%
Load voltage regulation	Load 0 – 100%		±0.5	%

Load voltage regulation 3.3V output	Load 0 – 100%		±1.5	%
Temperature coefficient			±0.02	%/°C
Ripple & Noise	At 20MHz Bandwidth		75	mV p-p

### General Specifications

Parameters	Conditions	Typical	Maximum	Units
Switching frequency	100% load	50		KHz
Operating temperature	Derating above 71°C		-25 to +85	°C
Storage temperature			-40 to +125	°C
Max Case temperature			100	°C
Cooling	Free air convection			%
Humidity			95	%
Case material	Plastic UL94-VO			
Weight		7		g
Dimensions(L x W x H)		1.26 x 0.32 x 0.57inches	32.00 x 8.13 x 14.48mm	
MTBF	>1 120 000 hrs(MIL-HDBK -217F, Ground Benign, t=+25°C)			

NOTE: All specifications in this datasheet are measured at an ambient temperature of 25°C, humidity<75%, nominal input voltage and at rated output load unless otherwise specified

### Safety Specifications

Standards	
Safety	Designed to meet IEC 60950-1
	EN55032, class B, with the recommended EMI circuit
	IEC61000-4-2(ESD) Criteria A
	IEC61000-4-3(Radiated immunity) Criteria A
	IEC61000-4-4(EFT) Criteria A, with the recommended EFT/Surge external circuit
	IEC61000-4-5(Surge) Criteria A, with the recommended EFT/Surge external circuit
	IEC61000-4-6(CS) Criteria A
	IEC61000-4-8(PFMF) Criteria A

### Pin Out Specifications

Pin	1000VDC	3000 and 5200VDC
1	+V Input	+V Input
2	N.C.	-V Input
3	N.C.	N.C.
9	N.C.	N.C.
10	-V Output	-V Output
11	+V Output	+V Output
12	-V Input	N.C.

### Dimensions

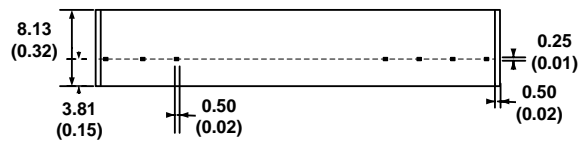
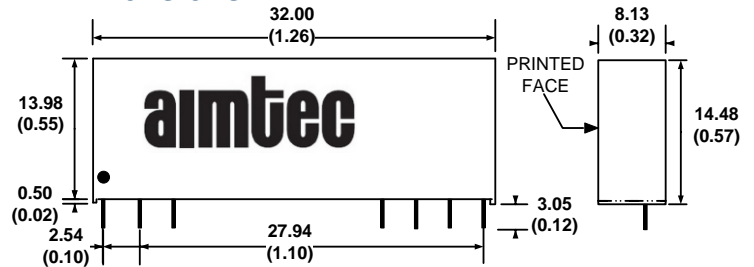

### Derating

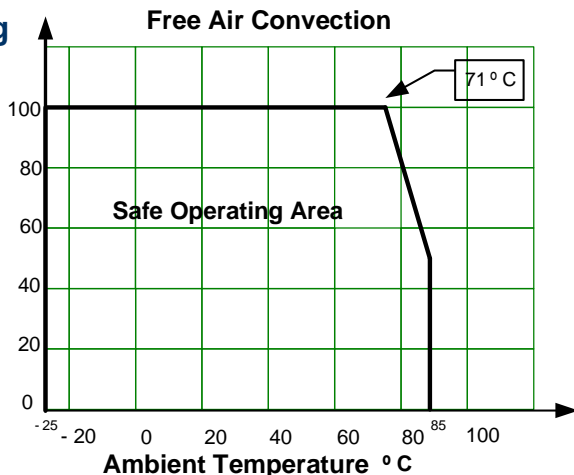

### Input Reflected Ripple Test Circuit

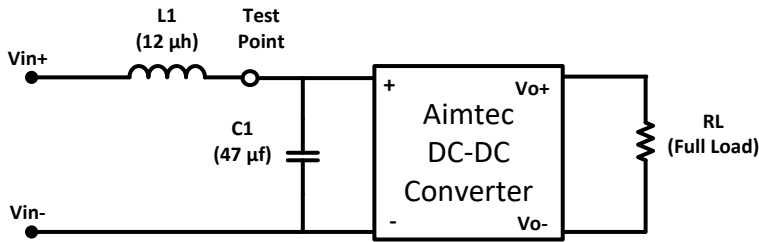

\* Tested at full load, and nominal input

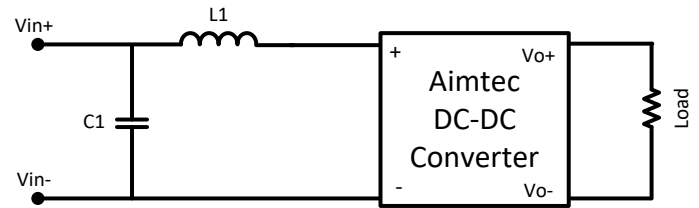

C1	L1
220μF/100V	12μH

### EFT/Surge Application circuit

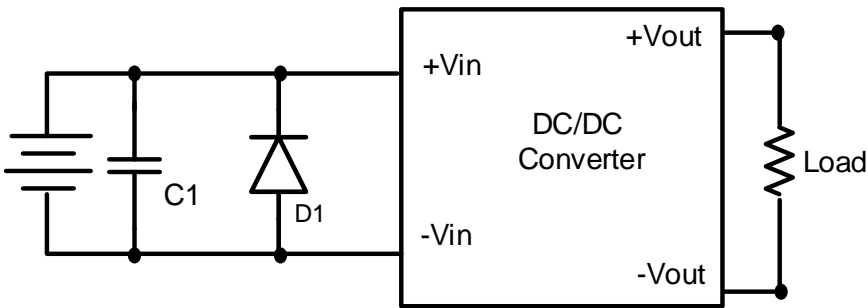

Vin	C1	D1
5VDC	1000μF/50V	TVS, 9V
12VDC		TVS, 14V
24VDC		TVS, 26V

### Typical Efficiency Example Charts

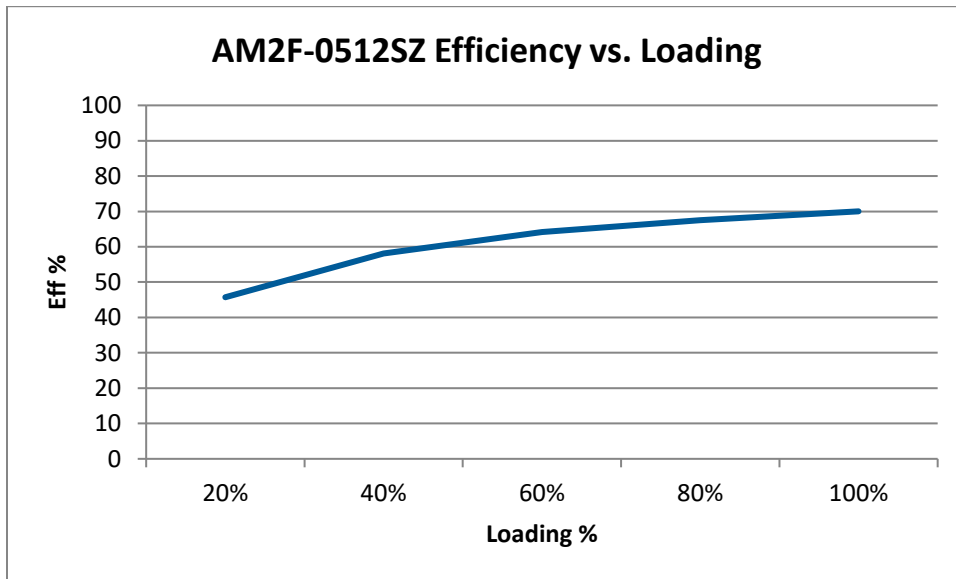

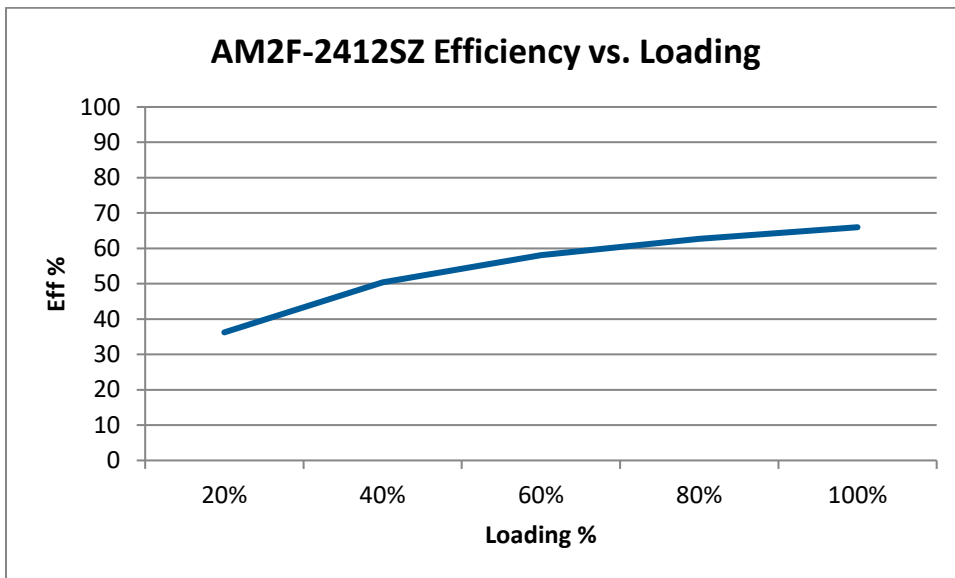
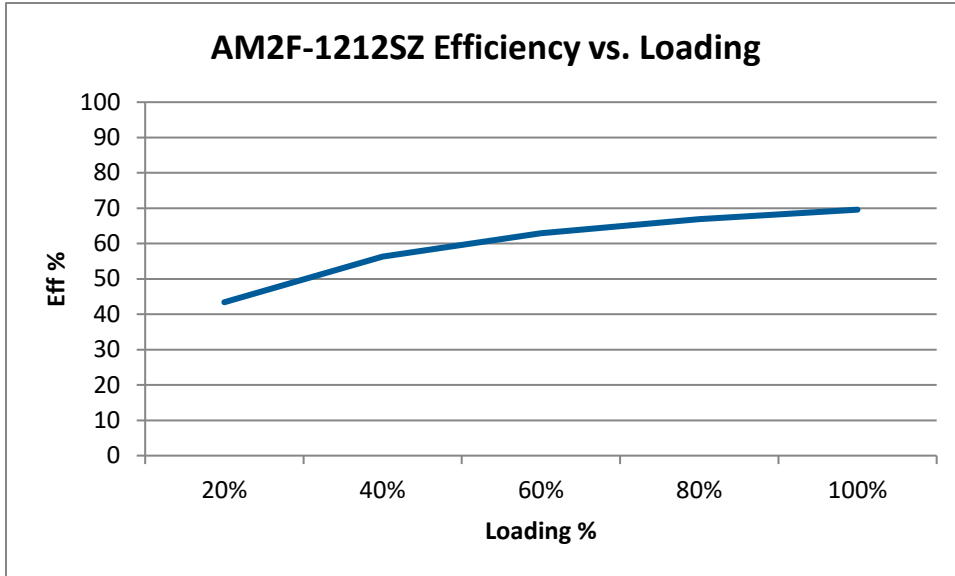

**NOTE:** **1.** Datasheets are updated as needed and as such, specifications are subject to change without notice. Once printed or downloaded, datasheets are no longer controlled by Aimtec; refer to [www.aimtec.com](http://www.aimtec.com) for the most current product specifications. **2.** Product labels shown, including safety agency certifications on labels, may vary based on the date manufactured. **3.** Mechanical drawings and specifications are for reference only. **4.** All specifications are measured at an ambient temperature of 25°C, humidity<75%, nominal input voltage and at rated output load unless otherwise specified. **5.** Aimtec may not have conducted destructive testing or chemical analysis on all internal components and chemicals at the time of publishing this document. CAS numbers and other limited information are considered proprietary and may not be available for release. **6.** This product is not designed for use in critical life support systems, equipment used in hazardous environments, nuclear control systems or other such applications which necessitate specific safety and regulatory standards other the ones listed in this datasheet. **7.** Warranty is in accordance with Aimtec's standard Terms of Sale available at [www.aimtec.com](http://www.aimtec.com).