



**SEMIPACK® 3**

## Rectifier Diode Modules

### SKKD 380

#### Features

- Heat transfer through aluminium nitride ceramic isolated metal baseplate
- Precise metal pressure contacts for high reliability
- UL recognized, file no. E 63 532

#### Typical Applications\*

- Uncontrolled rectifiers for AC/AC converters
- Line rectifiers for transistorized AC motor controllers
- Field supply for DC motors

$V_{RSM}$ V	$V_{RRM}$ V	$I_{FRMS} = 600$ A (maximum value for continuous operation) $I_{FAV} = 380$ A (sin. 180; $T_c = 100$ °C)	
900	800	SKKD 380/08	
1300	1200	SKKD 380/12	
1700	1600	SKKD 380/16	
1900	1800	SKKD 380/18	
2100	2000	SKKD 380/20H4	
2300	2200	SKKD 380/22H4	

Symbol	Conditions	Values	Units
$I_{FAV}$	sin. 180; $T_c = 100$ °C	380	A
$I_{FSM}$	$T_{vj} = 25$ °C; 10 ms	11000	A
	$T_{vj} = 150$ °C; 10 ms	10000	A
$i^2t$	$T_{vj} = 25$ °C; 8,3 ... 10 ms	605000	A <sup>2</sup> s
	$T_{vj} = 150$ °C; 8,3 ... 10 ms	500000	A <sup>2</sup> s
$V_F$	$T_{vj} = 25$ °C; $I_F = 1000$ A	max. 1,25	V
$V_{(TO)}$	$T_{vj} = 150$ °C	max. 0,8	V
$r_T$	$T_{vj} = 150$ °C	max. 0,35	mΩ
$I_{RD}$	$T_{vj} = 150$ °C; $V_{RD} = V_{RRM}$	max. 10	mA
$R_{th(j-c)}$	cont. per diode / per module sin. 180 per diode / per module	0,11 / 0,055 0,116 / 0,058	K/W K/W
$R_{th(c-s)}$	per diode / per module	0,04 / 0,02	K/W
$T_{vj}$		- 40 ... + 150	°C
$T_{stg}$		- 40 ... + 130	°C
$V_{isol}$	a. c. 50 Hz; r.m.s.; 1 s / 1 min.	3600 / 3000	V~
$V_{isol}$	a. c. 50 Hz; r.m.s.; 1 s / 1 min. for SKK ...H4	4800 / 4000	V~
$M_s$	to heatsink	5 ± 15 %	Nm
$M_t$	to terminals	9 ± 15 %	Nm
$a$		5 * 9,81	m/s <sup>2</sup>
$m$	approx.	600	g
Case		A 78b	

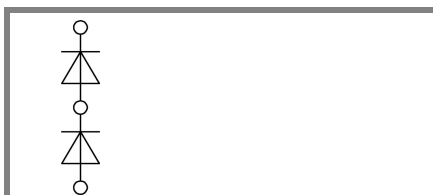

**SKKD**

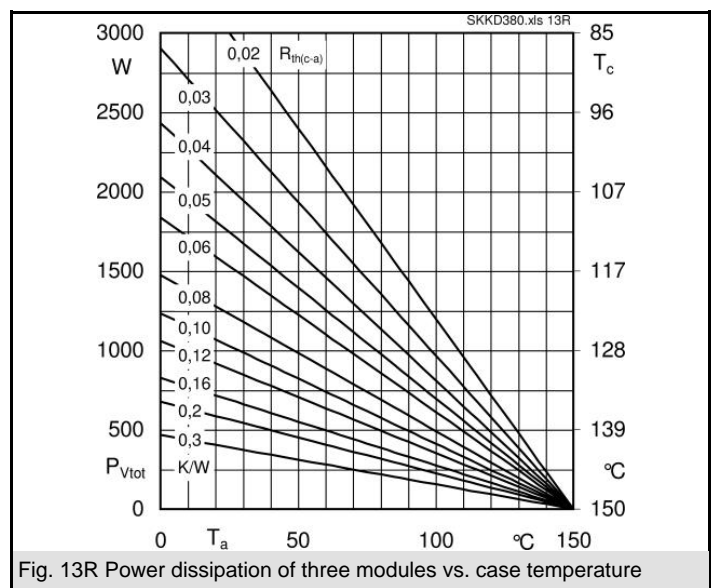
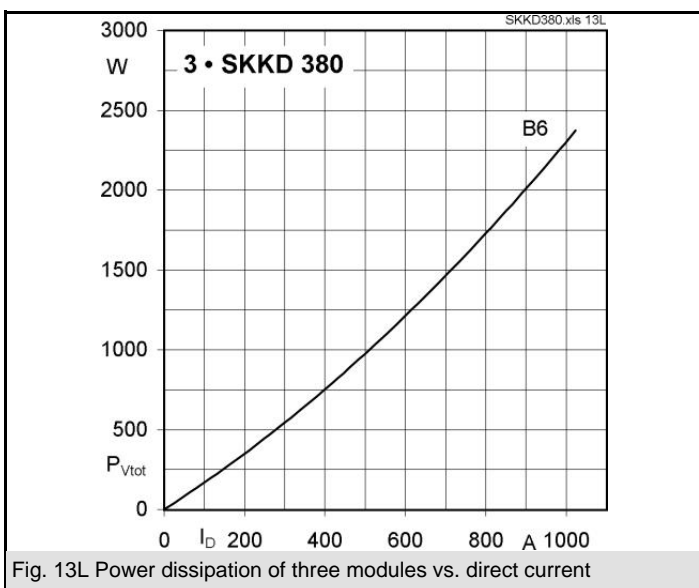
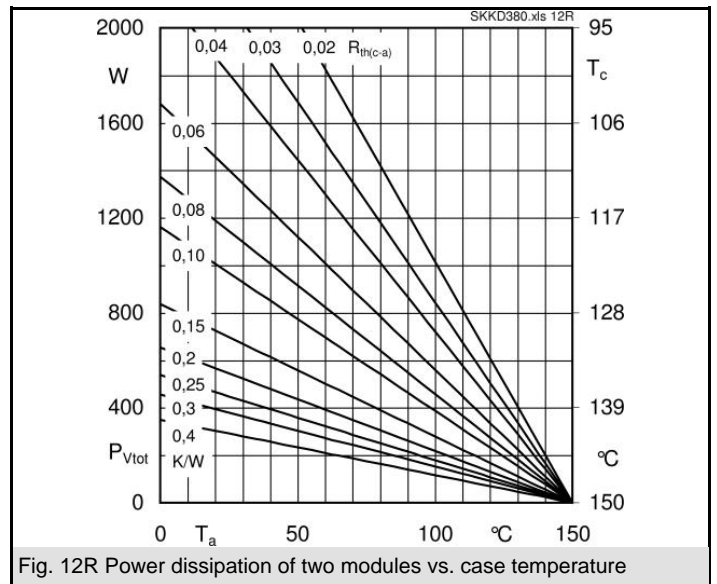
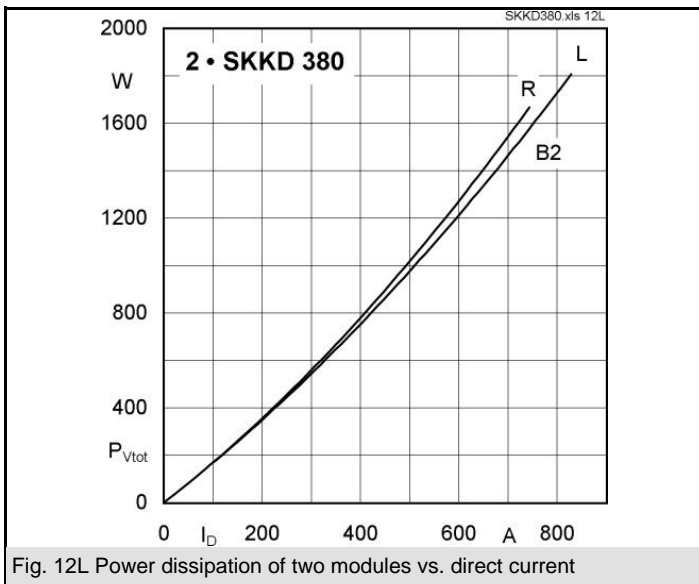
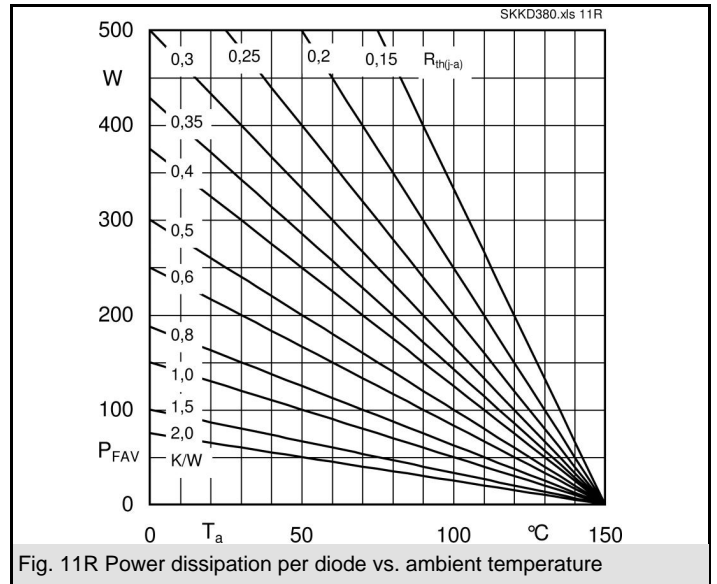
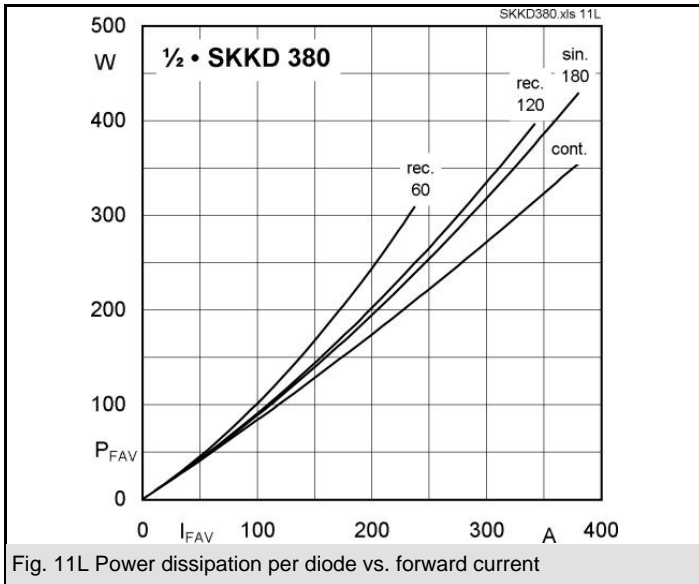

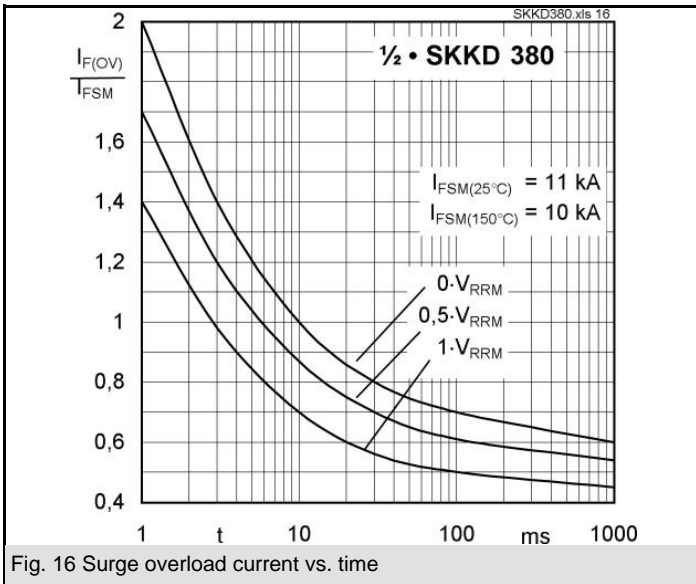
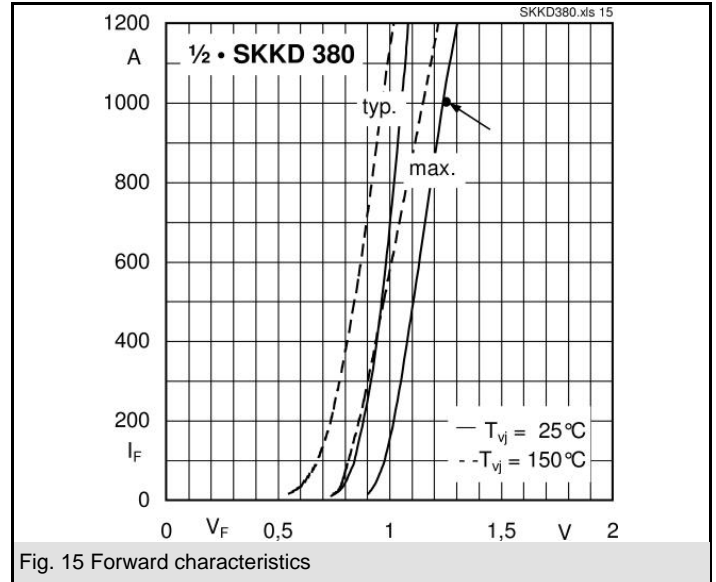
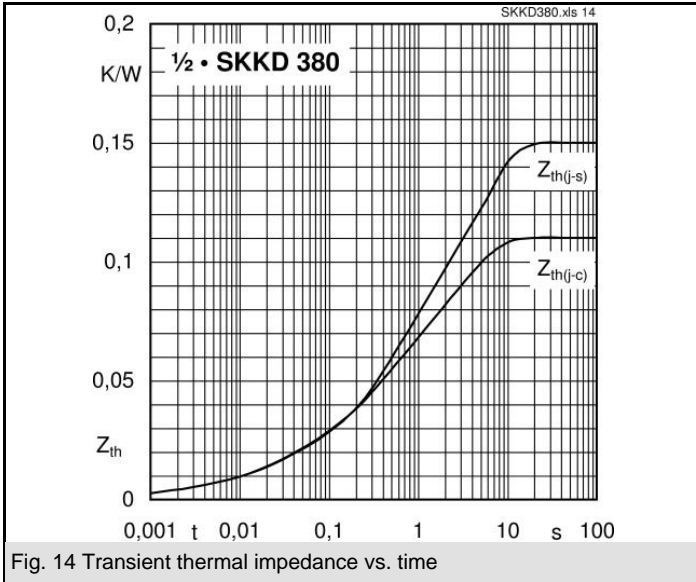

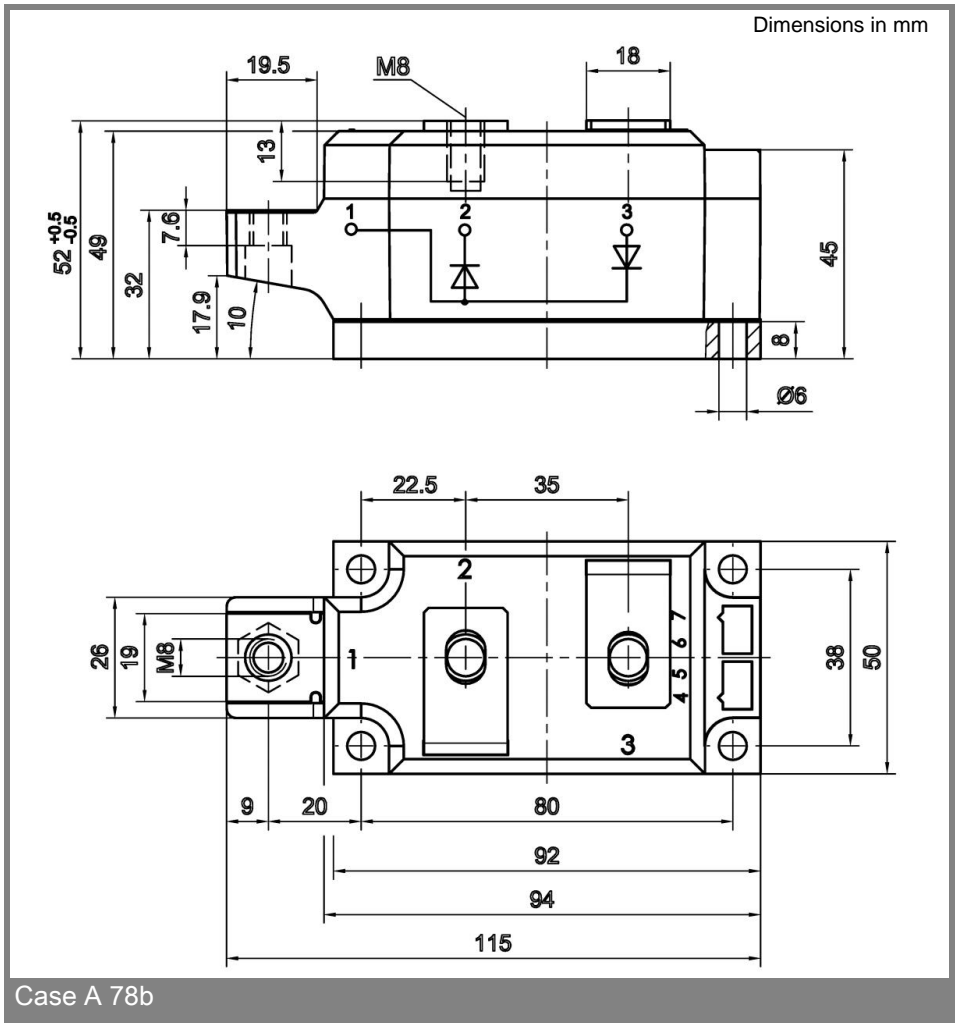

\* The specifications of our components may not be considered as an assurance of component characteristics. Components have to be tested for the respective application. Adjustments may be necessary. The use of SEMIKRON products in life support appliances and systems is subject to prior specification and written approval by SEMIKRON. We therefore strongly recommend prior consultation of our staff.