

# PCM2912A Audio Codec With USB Interface, Mono Microphone Input and Stereo Headphone Output

## 1 Features

- On-Chip USB Interface:
  - With Full-Speed Transceivers
  - Fully Compliant With USB 2.0 Specification
  - Certified By USB-IF
  - Partially Programmable Descriptors
  - Adaptive Isochronous Transfer for Playback
  - Asynchronous-Isochronous Transfer for Record
  - Bus Powered
- 16-Bit Delta-Sigma ADC and DAC
- Sampling Rate:
  - 8, 11.025, 16, 22.05, 32, 44.1, or 48 kHz
- On-Chip Clock Generator:
  - With Single 6-MHz Clock Source
- Mono ADC with Microphone Input
  - Analog Performance at  $V_{BUS} = 5\text{ V}$ :
    - THD+N: 0.01%
    - SNR: 92 dB
    - Dynamic Range: 90 dB
  - Decimation Digital Filter
    - Passband Ripple:  $\pm 0.05\text{ dB}$
    - Stop-Band Attenuation:  $-65\text{ dB}$
  - Single-Ended Voltage Input
  - Antialiasing Filter Included
  - Digital HPF Included
  - Microphone Bias, Microphone Amplifier, and Input PGA
- Stereo DAC With Headphone Output
  - Analog Performance at  $V_{BUS} = 5.0\text{ V}$ :
    - THD+N: 0.01% ( $R_L > 10\text{ k}\Omega$ )
    - THD+N: 0.02% ( $R_L = 32\ \Omega$ )
    - SNR: 92 dB
    - Dynamic Range: 90 dB
    - PO: 13 mW ( $R_L = 32\ \Omega$ )
    - PO: 25 mW ( $R_L = 16\ \Omega$ )
  - Oversampling Digital Filter
    - Passband Ripple:  $\pm 0.1\text{ dB}$
    - Stop-Band Attenuation:  $-43\text{ dB}$
  - Single-Ended Voltage Output
  - Analog LPF Included
  - Sidetone PGA, Output PGA, and HP Amplifier

- Multifunctions:
  - Suspend, Playback, and Record Status Flag
  - Microphone Amplifier, Mute, and Gain Control
- Pop/Click Noise-Free
- Single Power-Supply: 5 V Typical ( $V_{BUS}$ )
- Package: 32-Pin TQFP

## 2 Applications

- USB Headset
- USB Headphone
- USB Speaker
- USB Featured Consumer Audio Product
- USB Audio Interface Box
- USB Monitor
- Video Conference System

## 3 Description

The PCM2912A is the Texas Instruments single-chip, USB stereo audio codec with a USB, 2.0-compliant, full-speed protocol controller and an analog front-end (AFE) function for headset applications.

The USB protocol controller works with no software code, but USB descriptors can be modified on request. The PCM2912A employs SpAct™ architecture, TI's unique system that recovers the audio clock from USB packet data. On-chip analog PLLs with SpAct enables independent playback and record sampling rates with low clock jitters.

### Device Information<sup>(1)</sup>

PART NUMBER	PACKAGE	BODY SIZE (NOM)
PCM2912A	TQFP (32)	7.00 mm x 7.00 mm

(1) For all available packages, see the orderable addendum at the end of the data sheet.

### Block Diagram

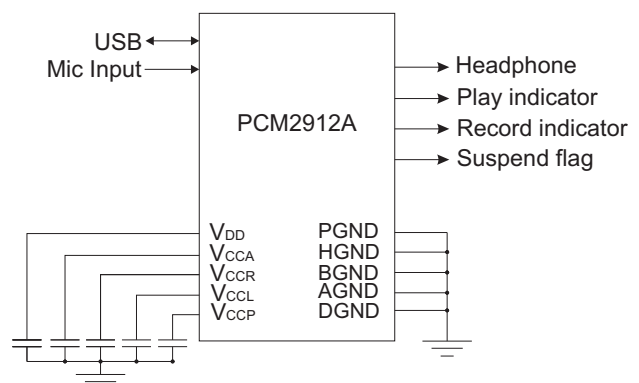

## Table of Contents

<b>1 Features</b> .....	<b>1</b>	9.3 Feature Description .....	<b>16</b>
<b>2 Applications</b> .....	<b>1</b>	9.4 Device Functional Modes .....	<b>19</b>
<b>3 Description</b> .....	<b>1</b>	9.5 Programming .....	<b>20</b>
<b>4 Revision History</b> .....	<b>2</b>	<b>10 Application and Implementation</b> .....	<b>24</b>
<b>5 Device Comparison Table</b> .....	<b>3</b>	10.1 Application Information .....	<b>24</b>
<b>6 Pin Configuration and Functions</b> .....	<b>3</b>	10.2 Typical Application .....	<b>24</b>
<b>7 Specifications</b> .....	<b>5</b>	<b>11 Power Supply Recommendations</b> .....	<b>27</b>
7.1 Absolute Maximum Ratings .....	<b>5</b>	<b>12 Layout</b> .....	<b>27</b>
7.2 ESD Ratings .....	<b>5</b>	12.1 Layout Guidelines .....	<b>27</b>
7.3 Recommended Operating Conditions .....	<b>5</b>	12.2 Layout Example .....	<b>27</b>
7.4 Thermal Information .....	<b>5</b>	<b>13 Device and Documentation Support</b> .....	<b>28</b>
7.5 Electrical Characteristics .....	<b>6</b>	13.1 Documentation Support .....	<b>28</b>
7.6 Typical Characteristics .....	<b>9</b>	13.2 Community Resources .....	<b>28</b>
<b>8 Parameter Measurement Information</b> .....	<b>14</b>	13.3 Trademarks .....	<b>28</b>
<b>9 Detailed Description</b> .....	<b>15</b>	13.4 Electrostatic Discharge Caution .....	<b>28</b>
9.1 Overview .....	<b>15</b>	13.5 Glossary .....	<b>28</b>
9.2 Functional Block Diagram .....	<b>15</b>	<b>14 Mechanical, Packaging, and Orderable Information</b> .....	<b>28</b>

## 4 Revision History

NOTE: Page numbers for previous revisions may differ from page numbers in the current version.

### Changes from Original (September 2008) to Revision A

Page

- Added *Pin Configuration and Functions* section, *ESD Ratings* table, *Feature Description* section, *Device Functional Modes*, *Application and Implementation* section, *Power Supply Recommendations* section, *Layout* section, *Device and Documentation Support* section, *Device Comparison* table, and *Mechanical, Packaging, and Orderable Information* section ..... **1**

## 5 Device Comparison Table

FEATURE	PCM2900C	PCM2902C	PCM2903C	PCM2906C	PCM2912A
Supply voltage	5 V (Bus-Powered)	5 V (Bus-Powered)	3.3 V (Bus-Powered)	5 V (Bus-Powered)	5 V (Bus-Powered)
Additional features	—	S/PDIF I/O	S/PDIF I/O	S/PDIF I/O 500-mA Maximum Power Configuration	Mic Bias PGAs Sidetone

## 6 Pin Configuration and Functions

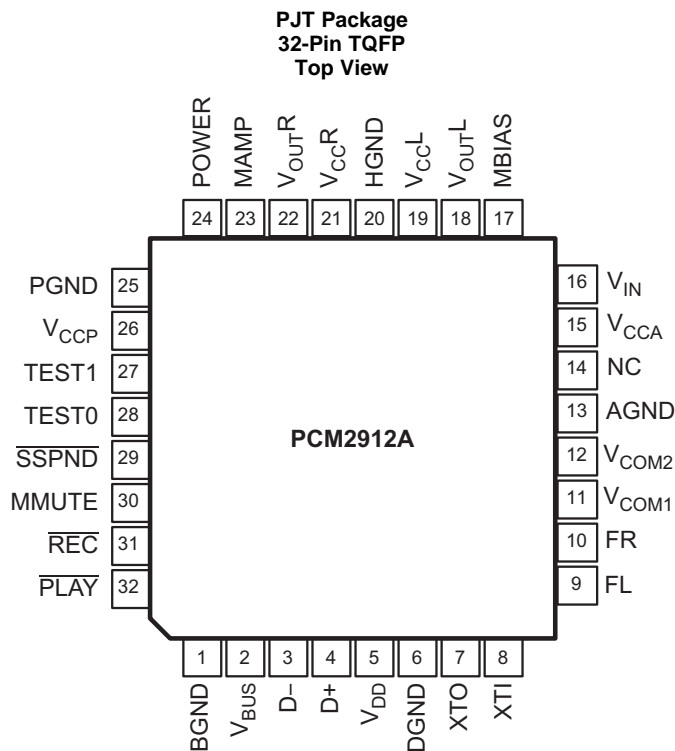

### Pin Functions

PIN		I/O	DESCRIPTION
NAME	NO.		
AGND	13	—	Analog ground
BGND	1	—	Reference for internal regulator
D-	3	I/O	USB differential input/output minus <sup>(1)</sup>
D+	4	I/O	USB differential input/output plus <sup>(1)</sup>
DGND	6	—	Digital ground
FL	9	—	External filter pin of L-channel (optional)
FR	10	—	External filter pin of R-channel (optional)
HGND	20	—	Analog ground for headphone amplifier
MAMP	23	I	Microphone preamplifier gain control (LOW: Preamplifier off, HIGH: Preamplifier on = +20 dB) <sup>(2)</sup>
MBIAS	17	O	Microphone bias output (0.75 V <sub>CCA</sub> )
MMUTE	30	I	Microphone mute control, active HIGH (LOW: Mute off, HIGH: Mute on) <sup>(3)</sup>
NC	14	—	Not connected

(1) LV-TTL level

(2) 3.3-V CMOS level input.

(3) 3.3-V CMOS level input with internal pulldown resistor.

**Pin Functions (continued)**

PIN		I/O	DESCRIPTION
NAME	NO.		
PGND	25	—	Analog ground for microphone bias, microphone amplifier, and PGA
PLAY	32	O	Status output for playback (LOW: Playback, FLASH: Mute on playback, HIGH: Stop) <sup>(4)</sup>
POWER	24	I	Power consumption declaration select pin (LOW: 100 mA, HIGH: 500 mA) <sup>(2)</sup>
REC	31	O	Status output for record (LOW: Record, FLASH: Mute on recode, HIGH: Stop) <sup>(4)</sup>
SSPND	29	O	Suspend flag (LOW: Suspend, HIGH: Operational state)
TEST0	28	I	Test pin. Must be set to LOW <sup>(2)</sup>
TEST1	27	I	Test pin. Must be set to HIGH <sup>(2)</sup>
V <sub>BUS</sub>	2	—	Connect to USB power (V <sub>BUS</sub> )
V <sub>CCA</sub>	15	—	Analog power supply
V <sub>CCL</sub>	19	—	Analog power supply for headphone amplifier of L-channel <sup>(5)</sup>
V <sub>CCP</sub>	26	—	Analog power supply for PLL <sup>(5)</sup>
V <sub>CCR</sub>	21	—	Analog power supply for headphone amplifier of R-channel <sup>(5)</sup>
V <sub>COM1</sub>	11	—	Common voltage for ADC, DAC, and analog front-end (V <sub>CCA</sub> /2). Decoupling capacitor must be connected to AGND.
V <sub>COM2</sub>	12	—	Common voltage for headphone (V <sub>CCA</sub> /2). Decoupling capacitor must be connected to AGND.
V <sub>DD</sub>	5	—	Digital power supply <sup>(5)</sup>
V <sub>IN</sub>	16	I	ADC microphone input
V <sub>OUTL</sub>	18	O	Headphone output for L-channel
V <sub>OUTR</sub>	22	O	Headphone output for R-channel
XTI	8	I	Crystal oscillator input <sup>(2)</sup>
XTO	7	O	Crystal oscillator output

(4) 5-V tolerant, open-drain.

(5) Connect decoupling capacitor to corresponding ground.

## 7 Specifications

### 7.1 Absolute Maximum Ratings

Over operating free-air temperature range (unless otherwise noted).<sup>(1)(2)</sup>

		MIN	MAX	UNIT
Supply voltage	V <sub>BUS</sub>	-0.3	6.5	V
Ground voltage differences	BGND, PGND, AGND, HGND, DGND	-0.1	0.1	V
Input voltage	V <sub>CCP</sub> , V <sub>CCA</sub> , V <sub>CCL</sub> , V <sub>CCR</sub> , V <sub>DD</sub>	-0.3	4	V
Digital input voltage	PLAY, REC	-0.3	6.5	V
	D+, D-, XTI, XTO, MMUTE, TEST0, TEST1, POWER, MAMP, SSPND	-0.3	4	V
Analog input voltage	MBIAS, V <sub>IN</sub> , V <sub>COM1</sub> , V <sub>COM2</sub> , V <sub>OUTL</sub> , V <sub>OUTR</sub> , FR, FL	-0.3	4	V
Input current (any pins except supplies)		-10	10	mA
Ambient temperature under bias		-40	125	°C
Junction temperature			150	
Storage temperature, T <sub>stg</sub>		-55	150	

- (1) Stresses beyond those listed under *Absolute Maximum Ratings* may cause permanent damage to the device. These are stress ratings only, and functional operation of the device at these or any other conditions beyond those indicated under *Recommended Operating Conditions* is not implied. Exposure to absolute-maximum-rated conditions for extended periods may affect device reliability.
- (2) All voltage values are with respect to network ground terminal.

### 7.2 ESD Ratings

		VALUE	UNIT
V <sub>(ESD)</sub>	Electrostatic discharge	Human body model (HBM), per ANSI/ESDA/JEDEC JS-001 <sup>(1)</sup>	±3000
		Charged device model (CDM), per JEDEC specification JESD22-C101 <sup>(2)</sup>	±1000

- (1) JEDEC document JEP155 states that 500-V HBM allows safe manufacturing with a standard ESD control process.
- (2) JEDEC document JEP157 states that 250-V CDM allows safe manufacturing with a standard ESD control process.

### 7.3 Recommended Operating Conditions

Over operating free-air temperature range (unless otherwise noted).

		MIN	NOM	MAX	UNIT
V <sub>BUS</sub>	Supply voltage	4.35	5	5.25	V
	Analog input voltage, full scale (-0 dB)	0.43 V <sub>CCA</sub>			V <sub>PP</sub>
	Digital input logic family	TTL			
	Digital input clock frequency	5.997	6	6.003	MHz
	Analog output load resistance	32			Ω
	Analog output load capacitance				100 pF
	Digital output load capacitance				10 pF
T <sub>A</sub>	Operating free-air temperature	-25		70	°C

### 7.4 Thermal Information

THERMAL METRIC <sup>(1)</sup>		PCM2912A	UNIT
		PJT (TQFP)	
		32 PINS	
R <sub>θJA</sub>	Junction-to-ambient thermal resistance	69.6	°C/W
R <sub>θJC(top)</sub>	Junction-to-case (top) thermal resistance	10.6	°C/W
R <sub>θJB</sub>	Junction-to-board thermal resistance	34.6	°C/W
Ψ <sub>JT</sub>	Junction-to-top characterization parameter	0.3	°C/W
Ψ <sub>JB</sub>	Junction-to-board characterization parameter	33.9	°C/W

- (1) For more information about traditional and new thermal metrics, see the *Semiconductor and IC Package Thermal Metrics* application report, [SPRA953](#).

## 7.5 Electrical Characteristics

All specifications at  $T_A = 25^\circ\text{C}$ ,  $V_{\text{BUS}} = 5\text{ V}$ ,  $f_S = 44.1\text{ kHz}$ ,  $f_{\text{IN}} = 1\text{ kHz}$ , and 16-bit data, unless otherwise noted. For Host interface, apply USB revision 2.0, full-speed. For audio data format, use UsB isochronous data format.

PARAMETER		TEST CONDITIONS	MIN	TYP	MAX	UNIT
<b>INPUT LOGIC</b>						
$V_{\text{IH}}$	Input logic high level		2		3.3	VDC
$V_{\text{IL}}$	Input logic low level				0.8	
$I_{\text{IH}}$	Input logic high current <sup>(1) (2)</sup>	$V_{\text{IN}} = 3.3\text{ V}$	-10		10	$\mu\text{A}$
	Input logic high current <sup>(3)</sup>	$V_{\text{IN}} = 3.3\text{ V}$		65	100	
$I_{\text{IL}}$	Input logic low current <sup>(1) (2)</sup>	$V_{\text{IN}} = 0\text{ V}$	-10		10	$\mu\text{A}$
	Input logic low current <sup>(3)</sup>	$V_{\text{IN}} = 0\text{ V}$	-10		10	
<b>OUTPUT LOGIC</b>						
$V_{\text{OH}}$	Output logic high level <sup>(1)</sup>	$I_{\text{OH}} = -10\text{ mA}$	2.9			VDC
	Output logic high level <sup>(4)</sup>	$I_{\text{OH}} = -2\text{ mA}$	2.8			
$V_{\text{OL}}$	Output logic low level <sup>(1)</sup>	$I_{\text{OL}} = 10\text{ mA}$			0.3	VDC
	Output logic low level <sup>(4)</sup>	$I_{\text{OL}} = 2\text{ mA}$			0.5	
	Output logic low level <sup>(5)</sup>	$I_{\text{OL}} = 8\text{ mA}$			0.5	
$I_{\text{OH}}$	Output leak current <sup>(5)</sup>	$V_{\text{IN}} = 5\text{ V}$			$\pm 10$	$\mu\text{A}$
<b>CLOCK FREQUENCY</b>						
	Input clock frequency, XTI		5.997	6.000	6.003	MHz
<b>MICROPHONE BIAS</b>						
	Output voltage			$0.75 V_{\text{CCA}}$		VDC
	Output current			2		mA
	Output noise	$R_L = 1\text{ k}\Omega$		5		$\mu\text{V}_{\text{RMS}}$
<b>ANALOG-TO-DIGITAL CONVERTER (ADC) CHARACTERISTICS</b>						
	Resolution			16		Bits
	Audio data channel			1		Channel
	Sampling frequency			8 11.025 16 22.05 32 44.1 48		kHz
<b>ADC DYNAMIC PERFORMANCE<sup>(6)</sup></b>						
THD+N	Total harmonic distortion plus noise	$V_{\text{IN}} = -1\text{ dB}$ of $0.43 V_{\text{CCA}}$		0.01%	0.02%	
	Dynamic range	A-weighted	82	90		dB
SNR	Signal-to-noise ratio	A-weighted	84	92		dB
<b>ADC DC ACCURACY</b>						
	Gain error			$\pm 2$	$\pm 10$	% of FSR
	Bipolar zero error			$\pm 0$		% of FSR
<b>ANALOG INPUT</b>						
	Input voltage			$0.43 V_{\text{CCA}}$		$V_{\text{PP}}$
	Center voltage			$0.5 V_{\text{CCA}}$		V
	Antialiasing filter frequency response	-3 dB		150		kHz
		$f_{\text{IN}} = 20\text{ kHz}$		-0.08		dB

(1) Pins 3, 4: D-, D+.

(2) Pins 8, 23, 24, 27, 28: XTI, MAMP, POWER, TEST1, TEST0

(3) Pin 30: MMUTE

(4) Pins 7, 29: XTO,  $\overline{\text{SSPND}}$

(5) Pins 31, 32: REC, PLAY.

(6)  $f_{\text{IN}} = 1\text{ kHz}$ , using Audio Precision™ System Two™, RMS mode with 20-kHz LPF, 400-Hz HPF in calculation. Microphone amplifier = 0 dB, PGA = 0 dB.

## Electrical Characteristics (continued)

All specifications at  $T_A = 25^\circ\text{C}$ ,  $V_{\text{BUS}} = 5\text{ V}$ ,  $f_S = 44.1\text{ kHz}$ ,  $f_{\text{IN}} = 1\text{ kHz}$ , and 16-bit data, unless otherwise noted. For Host interface, apply USB revision 2.0, full-speed. For audio data format, use UsB isochronous data format.

PARAMETER	TEST CONDITIONS	MIN	TYP	MAX	UNIT
<b>MICROPHONE AMPLIFIER</b>					
Gain		0		20	dB
Input impedance			20		k $\Omega$
<b>INPUT PGA</b>					
Gain range		-12		30	dB
Gain step size			1		dB
<b>ADC DIGITAL FILTER PERFORMANCE</b>					
Passband				0.454 $f_S$	Hz
Stop band		0.583 $f_S$			Hz
Passband ripple		-0.02		0.02	dB
Stop-band attenuation		-65			dB
Delay time			17.4/ $f_S$		s
HPF frequency response	-3 dB		0.078 $f_S/1000$		Hz
<b>DIGITAL-TO-ANALOG CONVERTER (DAC) CHARACTERISTICS</b>					
Resolution			16		Bits
Audio data channel			1, 2		Channel
Sampling frequency			8 11.025 16 22.05 32 44.1 48		kHz
<b>DAC DYNAMIC PERFORMANCE<sup>(7)</sup></b>					
THD+N	Total harmonic distortion plus noise	$R_L > 10\text{ k}\Omega$ , $V_{\text{OUT}} = 0\text{ dB}$ of $0.6 V_{\text{CCA}}$	0.01%	0.02%	
		$R_L = 32\ \Omega$ , $V_{\text{OUT}} = 0\text{ dB}$ of $0.55 V_{\text{CCA}}$	0.02%	0.05%	
	Dynamic range	EIAJ, A-weighted	82	90	dB
SNR	Signal-to-noise ratio	EIAJ, A-weighted	84	92	dB
	Channel separation	$R_L > 10\text{ k}\Omega$	80	88	dB
<b>DAC DC ACCURACY</b>					
	Gain mismatch channel-to-channel		-10	$\pm 2$	10 % of FSR
	Gain error		-10	$\pm 2$	10 % of FSR
	Bipolar zero error			$\pm 3$	% of FSR
<b>ANALOG OUTPUT</b>					
Output voltage	$R_L > 10\text{ k}\Omega$		0.6 $V_{\text{CCA}}$		$V_{\text{PP}}$
	$R_L = 32\ \Omega$		0.55 $V_{\text{CCA}}$		
Center voltage			0.5 $V_{\text{CCA}}$		V
Output power	$R_L = 32\ \Omega$		13		mW
	$R_L = 16\ \Omega$		25		
Load impedance (AC coupling)	Line		10		k $\Omega$
	Headphone		16	32	$\Omega$
LPF frequency response	-3 dB		140		kHz
	$f = 20\text{ kHz}$			-0.1	dB

(7)  $f_{\text{OUT}} = 1\text{ kHz}$ , using Audio Precision System Two, RMS mode with 20-kHz LPF, 400-Hz HPF. Output attenuator = 0 dB, Sidetone = Mute.

## Electrical Characteristics (continued)

All specifications at  $T_A = 25^\circ\text{C}$ ,  $V_{\text{BUS}} = 5\text{ V}$ ,  $f_S = 44.1\text{ kHz}$ ,  $f_{\text{IN}} = 1\text{ kHz}$ , and 16-bit data, unless otherwise noted. For Host interface, apply USB revision 2.0, full-speed. For audio data format, use UsB isochronous data format.

PARAMETER		TEST CONDITIONS	MIN	TYP	MAX	UNIT
<b>SIDETONE PROGRAMMABLE ATTENUATOR</b>						
Gain range			-76		0	dB
Gain step size				1		dB
<b>OUTPUT PROGRAMMABLE ATTENUATOR</b>						
Gain range			-76		0	dB
Gain step size				1		dB
<b>ANALOG LOOPBACK PERFORMANCE<sup>(8)</sup></b>						
THD+N	Total harmonic distortion plus noise	$R_L > 10\text{ k}\Omega$ , $V_{\text{IN}} = 0\text{ dB}$ of $0.43 V_{\text{CCA}}$		0.01%	0.02%	
		$R_L = 32\ \Omega$ , $V_{\text{IN}} = 0\text{ dB}$ of $0.43 V_{\text{CCA}}$		0.02%	0.05%	
Dynamic range		EIAJ, A-weighted	82	90		dB
SNR	Signal-to-noise ratio	EIAJ, A-weighted	84	92		dB
<b>DAC DIGITAL FILTER PERFORMANCE</b>						
Passband					$0.445 f_S$	Hz
Stop band			$0.555 f_S$			Hz
Passband ripple					$\pm 0.1$	dB
Stop-band attenuation			-43			dB
Delay time				$14.3/f_S$		s
<b>POWER-SUPPLY REQUIREMENTS</b>						
$V_{\text{BUS}}$	Voltage range	Bus-powered	4.35	5	5.25	VDC
Supply current		ADC, DAC operation ( $R_L = 32\ \Omega$ )		85	100	mA
		Suspend mode <sup>(9)</sup>		220	300	$\mu\text{A}$
Power dissipation		ADC, DAC Operation		425	500	mW
		Suspend mode <sup>(9)</sup>		0.8	1	mW
$V_{\text{CCP}}, V_{\text{CCL}}$ $V_{\text{CCR}}, V_{\text{CCA}}$ $V_{\text{DD}}$	Internally-generated power supply voltage <sup>(10)</sup>		3	3.3	3.6	VDC
<b>TEMPERATURE RANGE</b>						
Operation temperature			-25		85	$^\circ\text{C}$

(8) MIC Amp = 0 dB, Sidetone attenuator = 0 dB, Output attenuator = 0 dB.

(9) Under USB suspend state

(10) Pins 5, 15, 19, 21, 26:  $V_{\text{DD}}$ ,  $V_{\text{CCA}}$ ,  $V_{\text{CCL}}$ ,  $V_{\text{CCR}}$ ,  $V_{\text{CCP}}$ .



## 7.6 Typical Characteristics

### 7.6.1 ADC Digital Decimation Filter Frequency Response

All specifications at  $T_A = 25^\circ\text{C}$ ,  $V_{\text{BUS}} = 5\text{ V}$ ,  $f_S = 44.1\text{ kHz}$ ,  $f_{\text{IN}} = 1\text{ kHz}$ , and 16-bit data, unless otherwise noted.

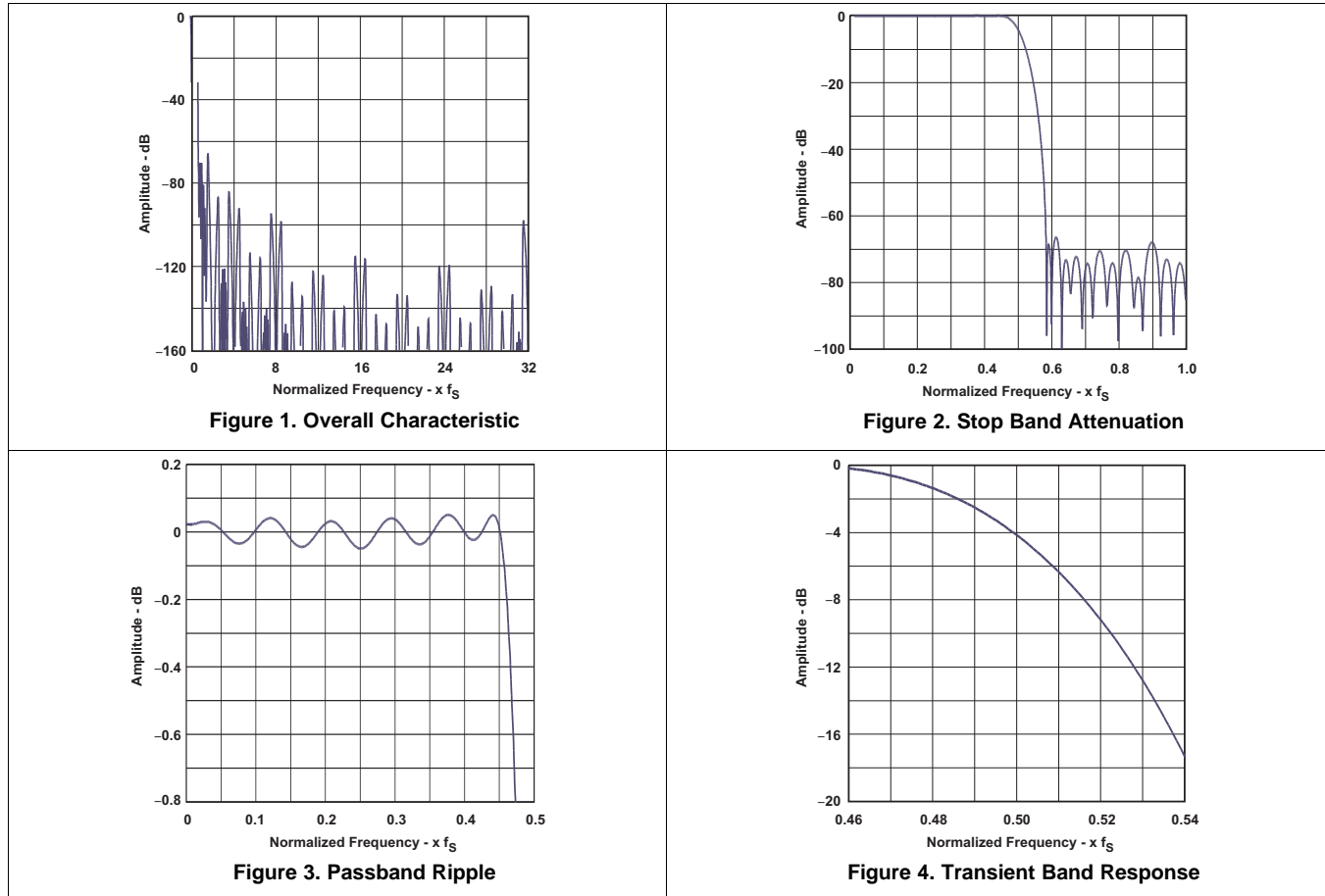

### 7.6.2 ADC Digital High-Pass Filter Frequency Response

All specifications at  $T_A = 25^\circ\text{C}$ ,  $V_{\text{BUS}} = 5\text{ V}$ ,  $f_S = 44.1\text{ kHz}$ ,  $f_{\text{IN}} = 1\text{ kHz}$ , and 16-bit data, unless otherwise noted.

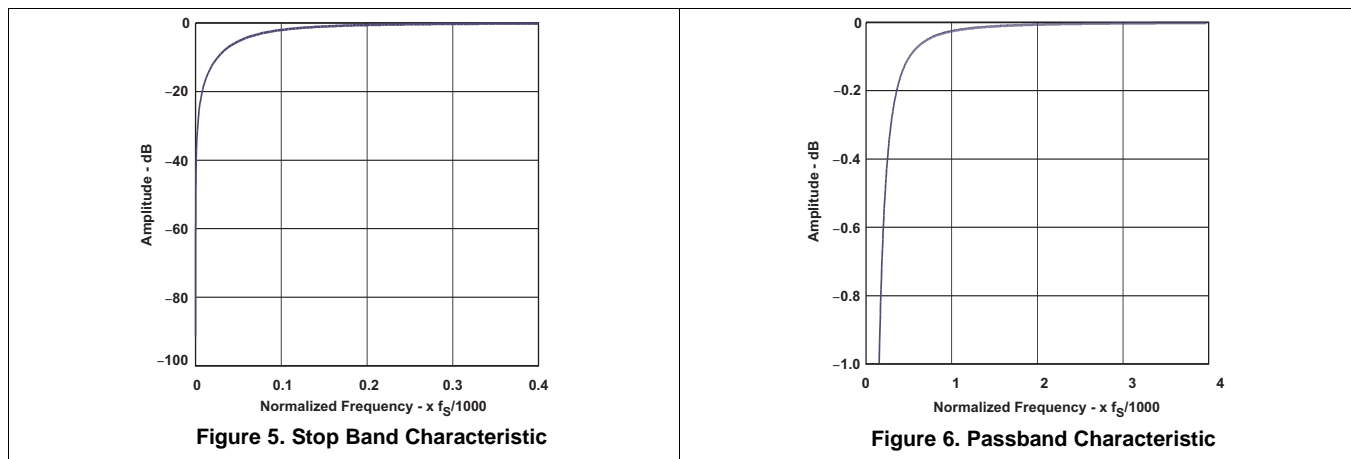

### 7.6.3 ADC Analog Antialiasing Filter Frequency Response

All specifications at  $T_A = 25^\circ\text{C}$ ,  $V_{\text{BUS}} = 5\text{ V}$ ,  $f_S = 44.1\text{ kHz}$ ,  $f_{\text{IN}} = 1\text{ kHz}$ , and 16-bit data, unless otherwise noted.

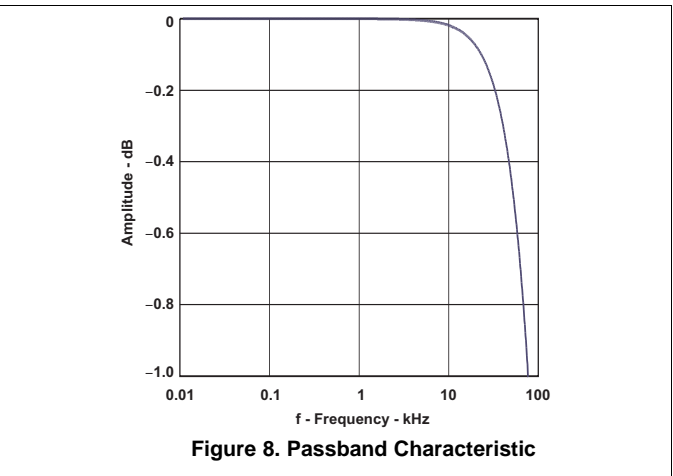
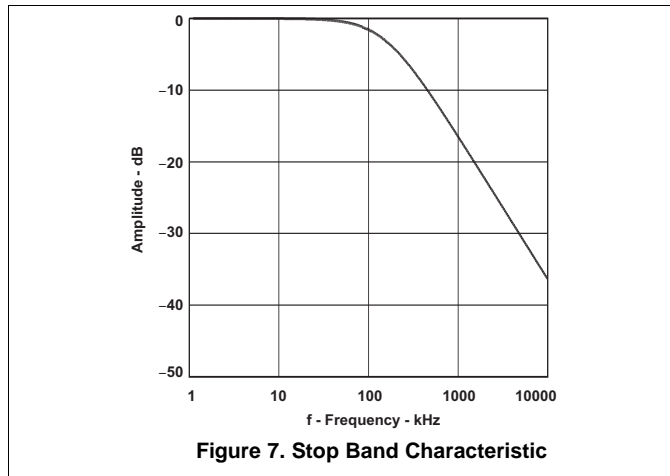

### 7.6.4 DAC Digital Interpolation Filter Frequency Response

All specifications at  $T_A = 25^\circ\text{C}$ ,  $V_{\text{BUS}} = 5\text{ V}$ ,  $f_S = 44.1\text{ kHz}$ ,  $f_{\text{IN}} = 1\text{ kHz}$ , and 16-bit data, unless otherwise noted.

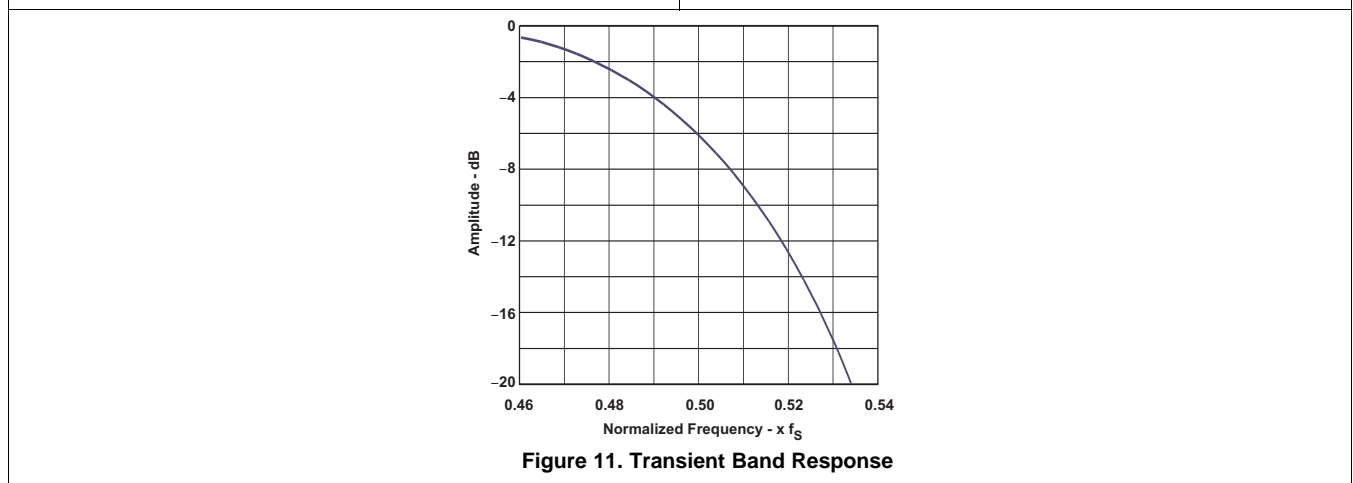
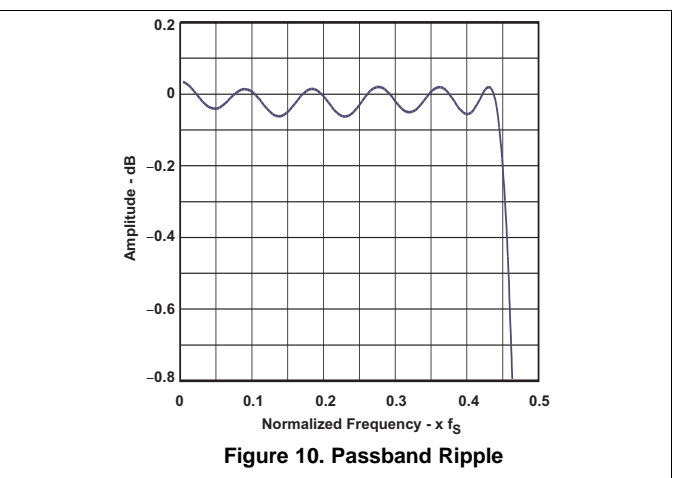
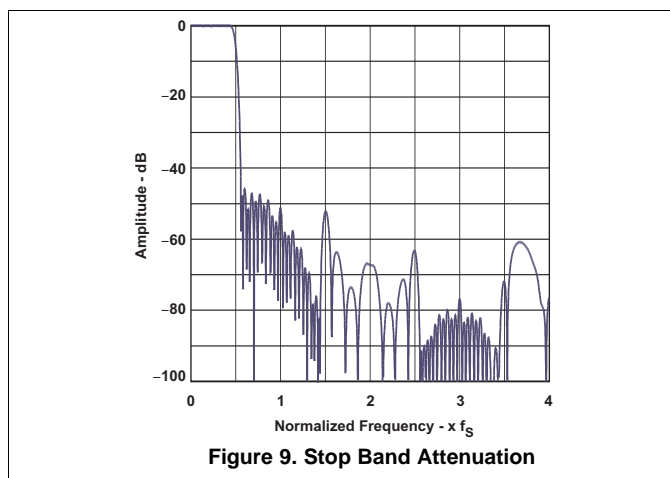

### 7.6.5 DAC Analog FIR Filter Frequency Response

All specifications at  $T_A = 25^\circ\text{C}$ ,  $V_{\text{BUS}} = 5\text{ V}$ ,  $f_S = 44.1\text{ kHz}$ ,  $f_{\text{IN}} = 1\text{ kHz}$ , and 16-bit data, unless otherwise noted.

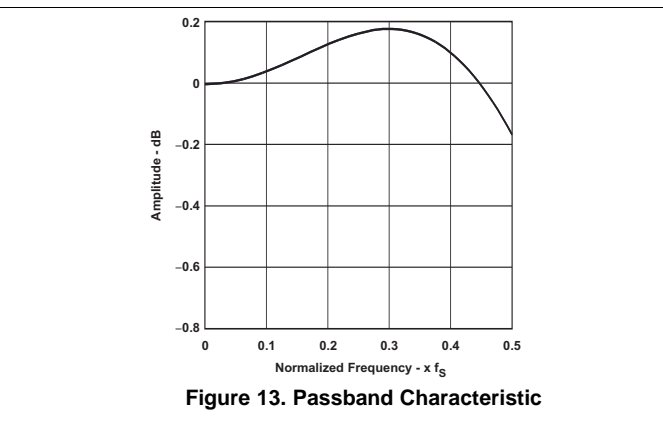
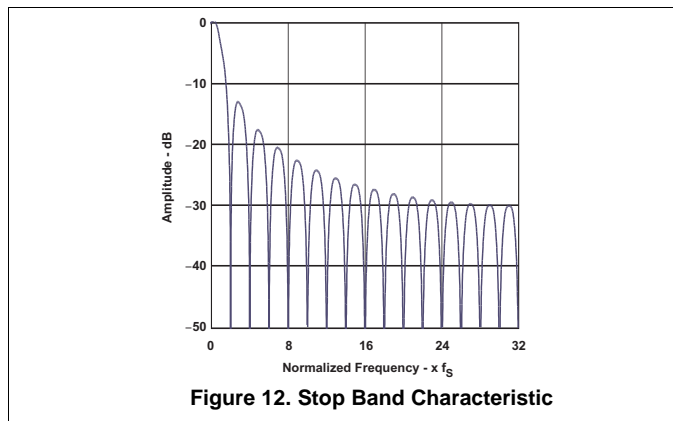

### 7.6.6 DAC Analog Low-Pass Filter Frequency Response

All specifications at  $T_A = 25^\circ\text{C}$ ,  $V_{\text{BUS}} = 5\text{ V}$ ,  $f_S = 44.1\text{ kHz}$ ,  $f_{\text{IN}} = 1\text{ kHz}$ , and 16-bit data, unless otherwise noted.

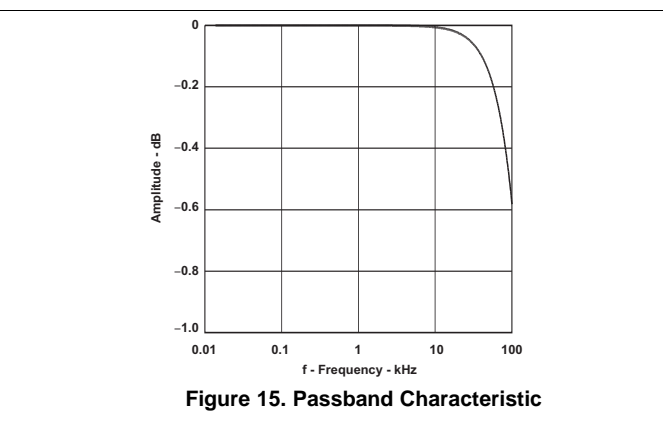
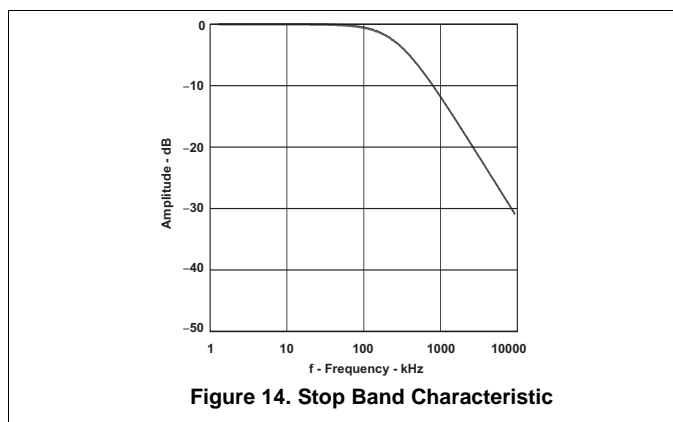

### 7.6.7 ADC

All specifications at  $T_A = 25^\circ\text{C}$ ,  $V_{\text{BUS}} = 5\text{ V}$ ,  $f_S = 44.1\text{ kHz}$ ,  $f_{\text{IN}} = 1\text{ kHz}$ , and 16-bit data, unless otherwise noted.

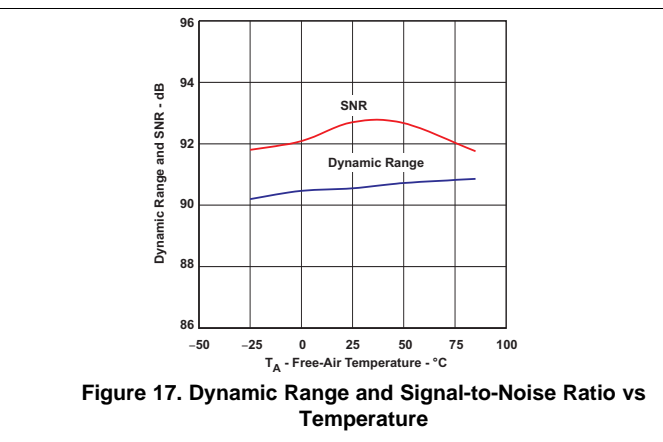
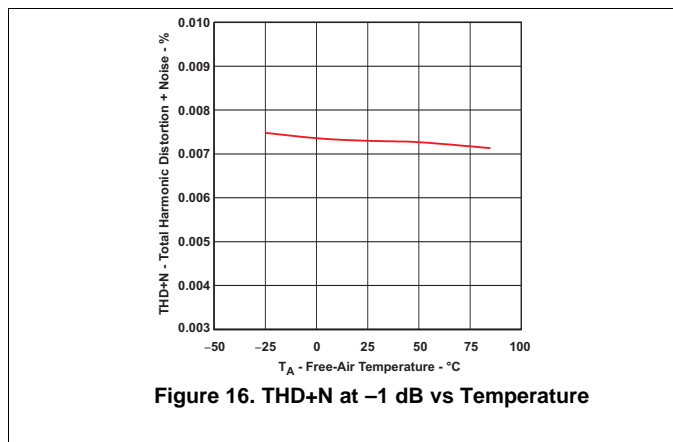

### ADC (continued)

All specifications at  $T_A = 25^\circ\text{C}$ ,  $V_{\text{BUS}} = 5\text{ V}$ ,  $f_S = 44.1\text{ kHz}$ ,  $f_{\text{IN}} = 1\text{ kHz}$ , and 16-bit data, unless otherwise noted.

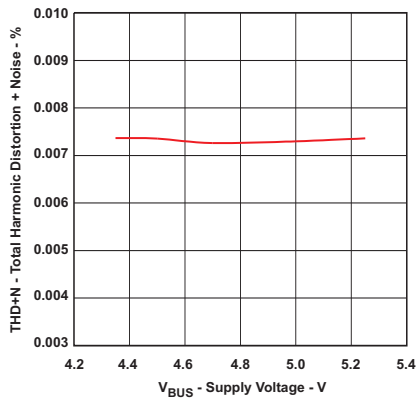

Figure 18. THD+N at -1 dB vs Supply Voltage

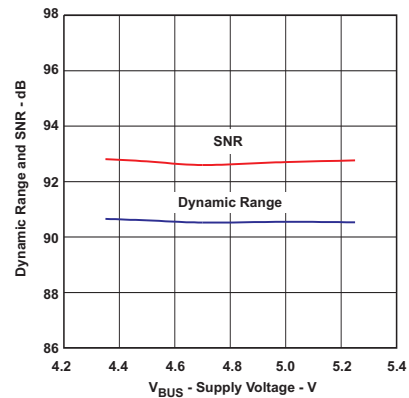

Figure 19. Dynamic Range and Signal-to-Noise Ratio vs Supply Voltage

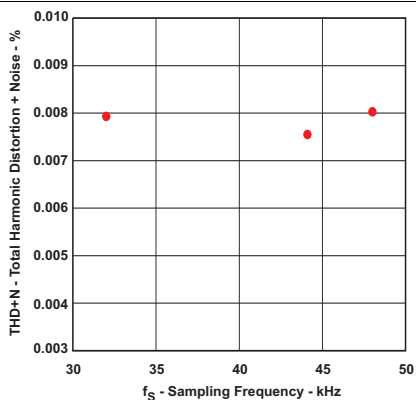

Figure 20. THD+N at -1 dB vs Sampling Frequency

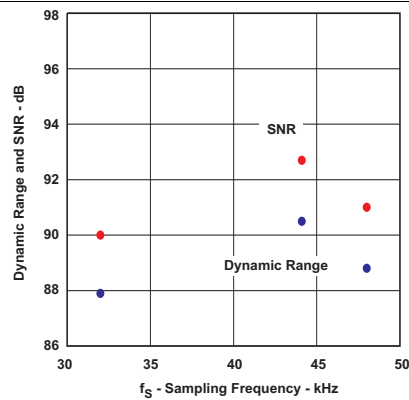

Figure 21. Dynamic Range and Signal-to-Noise Ratio vs Sampling Frequency

### 7.6.8 DAC

All specifications at  $T_A = 25^\circ\text{C}$ ,  $V_{\text{BUS}} = 5\text{ V}$ ,  $f_S = 44.1\text{ kHz}$ ,  $f_{\text{IN}} = 1\text{ kHz}$ , and 16-bit data, unless otherwise noted.

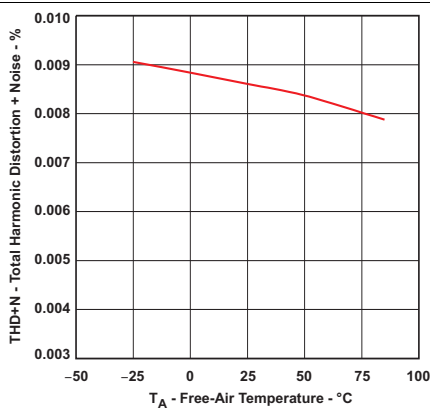

Figure 22. THD+N at 0 dB vs Temperature

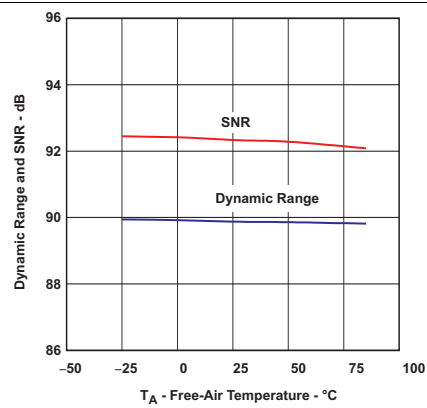

Figure 23. Dynamic Range and Signal-to-Noise Ratio vs Temperature

### DAC (continued)

All specifications at  $T_A = 25^\circ\text{C}$ ,  $V_{\text{BUS}} = 5\text{ V}$ ,  $f_S = 44.1\text{ kHz}$ ,  $f_{\text{IN}} = 1\text{ kHz}$ , and 16-bit data, unless otherwise noted.

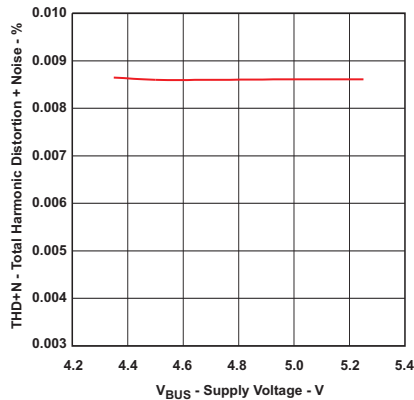

Figure 24. THD+N at 0 dB vs Supply Voltage

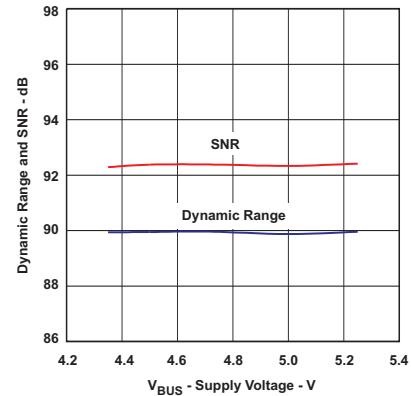

Figure 25. Dynamic Range and Signal-to-Noise Ratio vs Supply Voltage

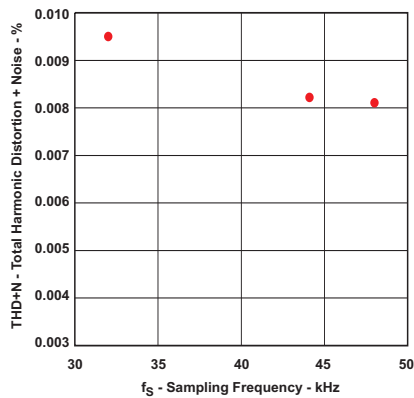

Figure 26. THD+N at 0 dB vs Sampling Frequency

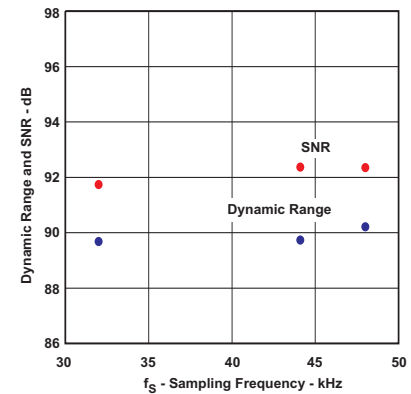

Figure 27. Dynamic Range and Signal-to-Noise Ratio vs Sampling Frequency

### 7.6.9 Supply Current

All specifications at  $T_A = 25^\circ\text{C}$ ,  $V_{\text{BUS}} = 5\text{ V}$ ,  $f_S = 44.1\text{ kHz}$ ,  $f_{\text{IN}} = 1\text{ kHz}$ , and 16-bit data, unless otherwise noted.

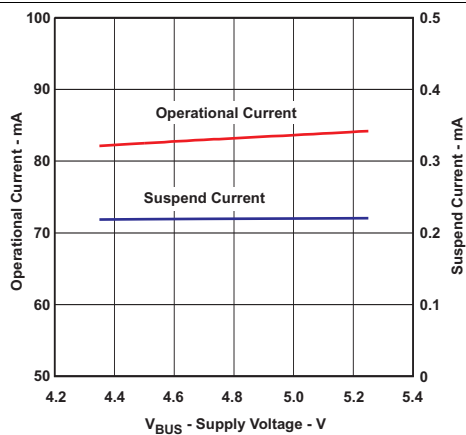

Figure 28. Supply Current vs Supply Voltage

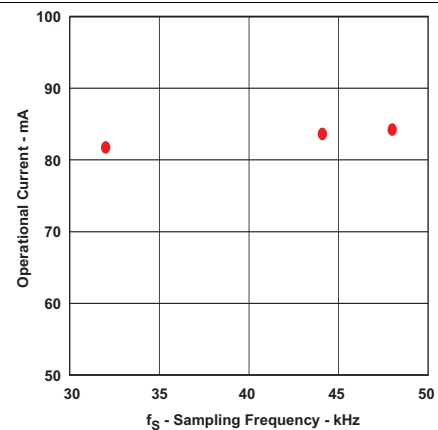
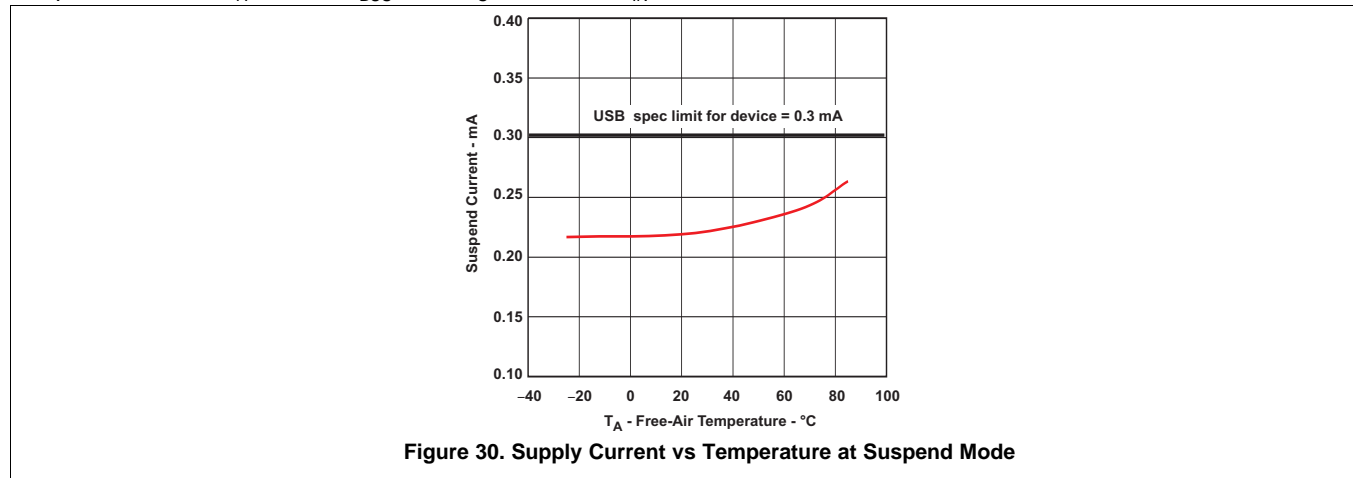

Figure 29. Supply Current vs Sampling Frequency

### Supply Current (continued)

All specifications at  $T_A = 25^\circ\text{C}$ ,  $V_{\text{BUS}} = 5\text{ V}$ ,  $f_S = 44.1\text{ kHz}$ ,  $f_{\text{IN}} = 1\text{ kHz}$ , and 16-bit data, unless otherwise noted.



## 8 Parameter Measurement Information

All parameters are measured according to the conditions described in [Specifications](#).

## 9 Detailed Description

### 9.1 Overview

The PCM2912A is an audio codec with USB connection capability and an analog front-end for headset applications.

The PCM2912A is a bus-powered device that uses the USB voltage source. The PCM2912A meets the requirements of USB2.0 standard connection. This device has analog and digital inputs and outputs; it has a digital USB interface for input and output data; the analog input is directly routed to the A/D converter and to the analog output. The microphone input has an optional mic amp with fixed +20 dB. The PCM2912A has 2 digital output flags that can be used as LED indicators for Playback and Record. The PCM2912A requires a 12-MHz clock; it can be provided by an external clock or generated by a built-in crystal resonator.

### 9.2 Functional Block Diagram

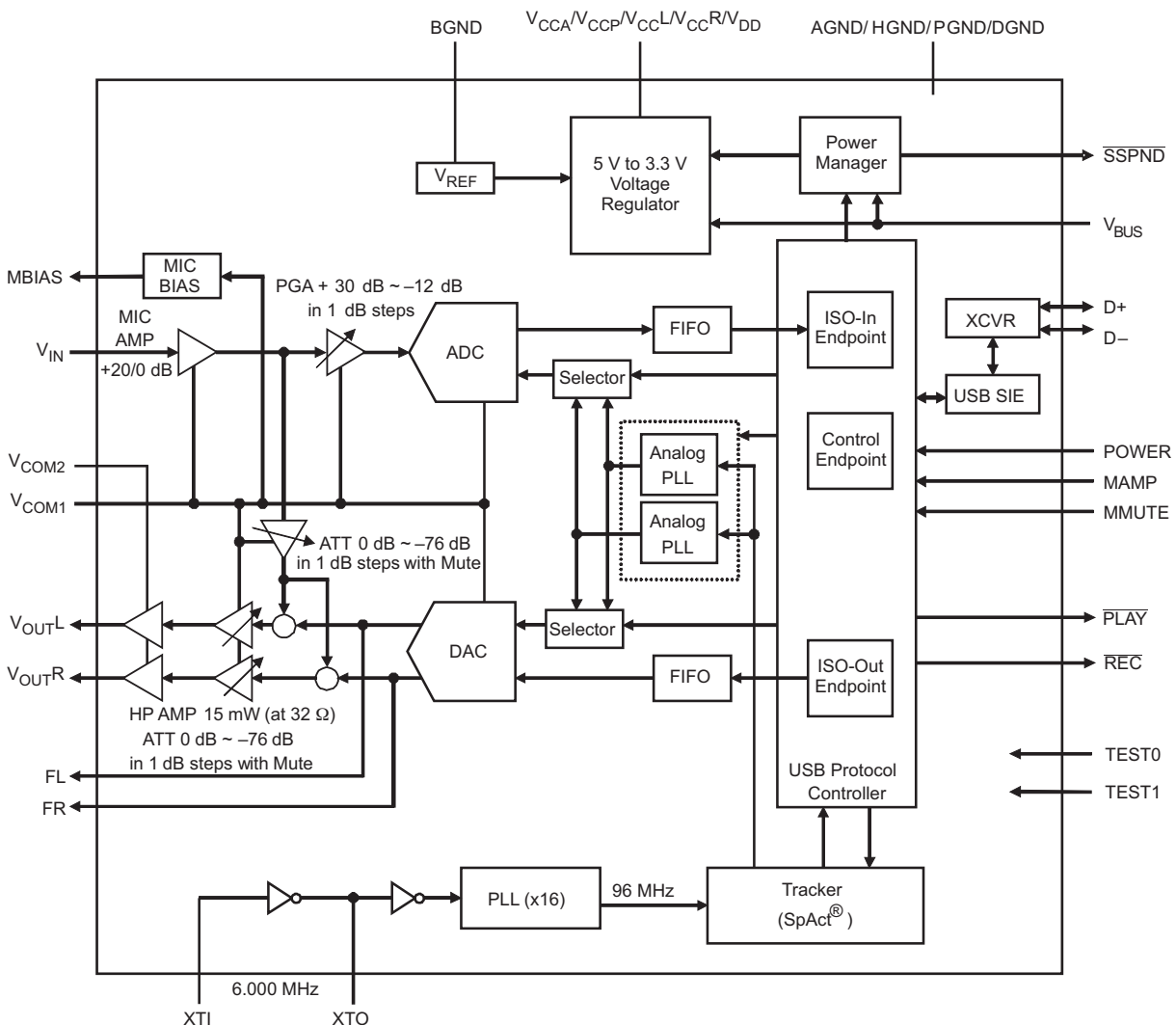

## 9.3 Feature Description

### 9.3.1 Clock and Reset

The PCM2912A requires a 6-MHz ( $\pm 500$  ppm) clock for USB function and audio function, which can be generated from a built-in crystal oscillator with a 6-MHz crystal resonator. The 6-MHz crystal resonator must be connected to XTI (pin 8) and XTO (pin 7) with one high (1-M $\Omega$ ) resistor and two small capacitors, whose capacitance depends on the load capacitance of the crystal resonator. An external clock can be supplied through XTI; if an external clock is supplied, XTO must be left open. Because there is no clock disabling signal, using the external clock supply is not recommended. SSPND (pin 29) is unable to use clock disabling.

The PCM2912A has an internal power-on-reset circuit, which works automatically when  $V_{BUS}$  (pin 2) exceeds 2.5 V, typical (2.2 V to 2.7 V), and approximately 700  $\mu$ s is required until the internal reset is released.

### 9.3.2 DAC

The PCM2912A has a stereo delta-sigma DAC that uses a  $64\text{-}f_S$  oversampling technique with an  $8\text{-}f_S$  oversampling digital filter. DAC outputs are provided through the headphone amplifier;  $V_{OUTL}$  (pin 18) and  $V_{OUTR}$  (pin 22) provide 13 mW at 32  $\Omega$  and  $0.6 V_{CC}/V_{CCR}$   $V_{PP}$  at a 10-k $\Omega$  load.

### 9.3.3 ADC

The PCM2912A has a mono delta-sigma ADC that uses a  $64\text{-}f_S$  oversampling technique with a  $1/64\text{-}f_S$  decimation digital filter. The microphone input,  $V_{IN}$  (pin 16), is fed to the ADC through a +20-dB microphone amplifier and the PGA, which has +30 dB to –12 dB in 1-dB steps.

### 9.3.4 Microphone Bias

The PCM2912A has a microphone bias generator, which provides a low-noise,  $0.75\text{-}V_{CCA}$ , 2-mA source current output with appropriate output impedance for electret-microphone driving. This output, MBIAS (pin 17), should be bypassed to AGND (pin 13) through an appropriate capacitor to reduce the output noise level.

### 9.3.5 Microphone Amplifier

The PCM2912A has a low-noise, single-ended, mono microphone amplifier with a mute function that is controlled by MUTE (pin 30). The signal gain is selectable by MAMP (pin 23). The noise level at the input node is 5  $\mu$ V<sub>RMS</sub>, and the input impedance is 20 k $\Omega$ .

### 9.3.6 Input PGA

The PCM2912A also has a low-noise input, programmable gain amplifier (PGA) for the microphone amplifier output/ADC input, with a gain range of +30 dB to –12 dB in 1dB/step.

### 9.3.7 Sidetone Programmable Attenuator

The PCM2912A has a low-noise, sidetone programmable attenuator with a mute function for the sidetone signal path (microphone amplifier output to output PGA input), and a gain range of 0 dB to –76 dB in 1 dB/step.

### 9.3.8 Output Programmable Attenuator

The PCM2912A has a low-noise output programmable attenuator with a mute function for mixed signal, which affects DAC output signal and sidetone signal. The output PGA gain range is 0 dB to –76 dB in 1 dB/step.

### 9.3.9 $V_{COM1}$ and $V_{CCM2}$

$V_{COM2}$  (pin 12) is provided for the center voltage of the headphone amplifier.  $V_{COM1}$  (pin 11) is provided for the center voltage of all other analog circuits. Each  $V_{COM}$  pin must be decoupled with an appropriate capacitor. Because the headphone output is disconnected when entering the suspend state, determining the capacitance is important to prevent pop noise, especially for  $V_{COM2}$  (pin 12). The equivalent resistance of  $V_{COM2}$  is 500 k $\Omega$ , and  $V_{COM1}$  is 15 k $\Omega$ .



## Feature Description (continued)

### 9.3.10 Filter Pins

FL (pin 9) and FR (pin 10) are provided to make a low-pass filter (LPF) to decrease the DAC outband noise, as shown in Figure 31. This filter is optional.

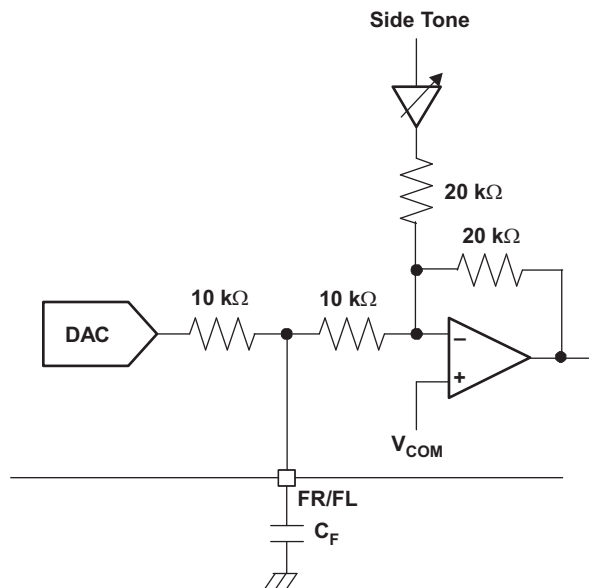

Figure 31. Filter Circuit

### 9.3.11 Interface Sequence

#### 9.3.11.1 Power-On, Attach, and Play Back Sequence

The PCM2912A is ready for setup when the reset sequence has finished and the USB bus is attached. After a connection has been established, the PCM2912A is ready to accept USB audio data. While waiting for the audio data (that is, in an idle state), the analog output is set to bipolar zero (BPZ).

When receiving the audio data, the PCM2912A stores the first audio packet, which contains 1-ms audio data, into the internal storage buffer. The PCM2912A starts playing the audio data when the subsequent Start of Frame (SOF) packet is detected, as shown in Figure 32.

Feature Description (continued)

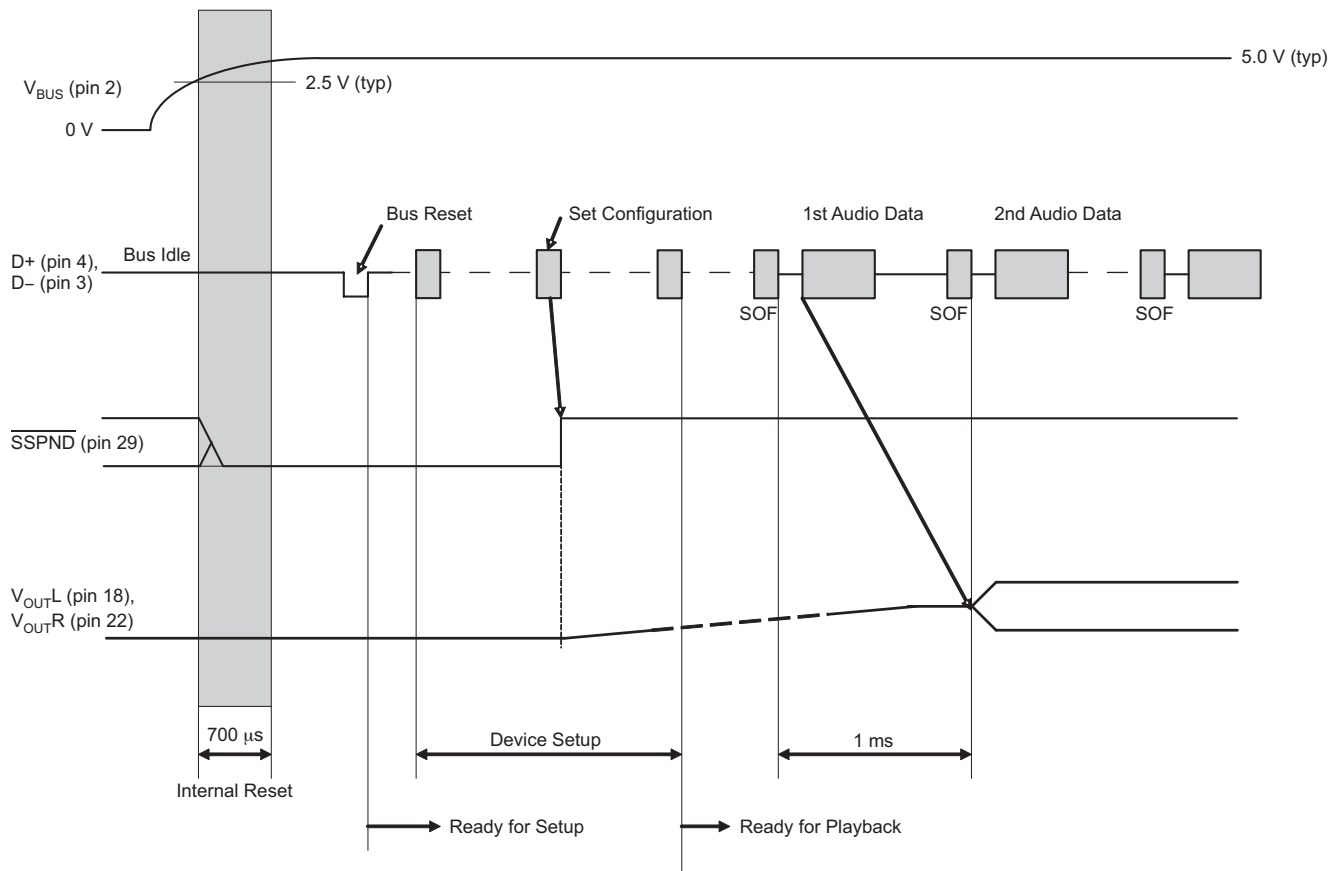

Figure 32. Initial Sequence

9.3.11.2 Play, Stop, and Detach Sequence

When the host finishes or aborts the play back process, the PCM2912A stops playing after last audio data has played, as shown in Figure 33.

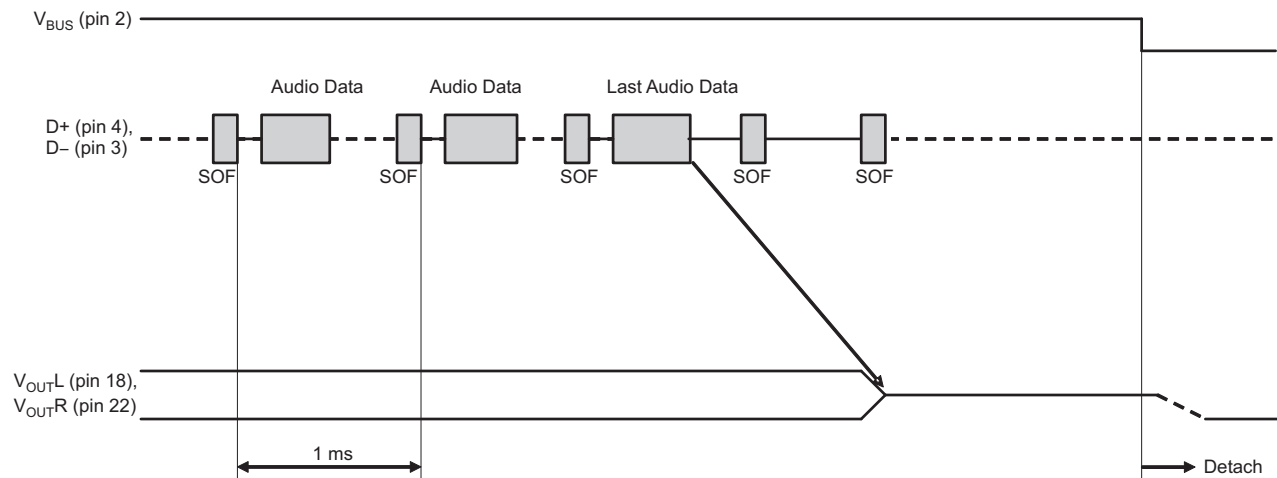

Figure 33. Play, Stop, and Detach

## Feature Description (continued)

### 9.3.11.3 Record Sequence

Figure 34 illustrates how the PCM2912A records the audio into the internal memory after receiving the SET\_INTERFACE command.

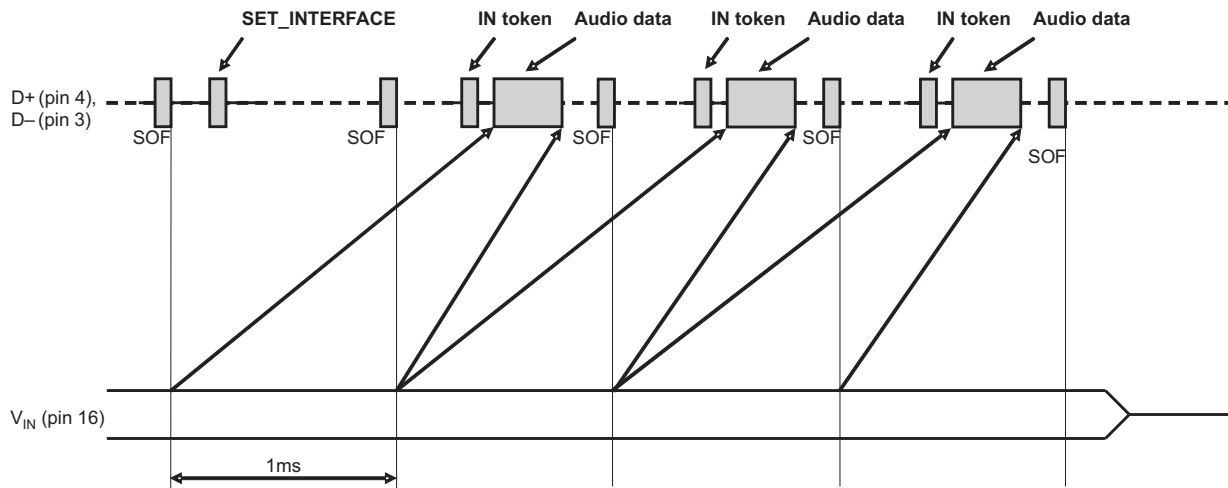

Figure 34. Record Sequence

### 9.3.11.4 Suspend and Resume Sequence

The PCM2912A enters a suspend state when it sees a constant idle state on the USB bus after approximately 5 ms. When the PCM2912A enters the suspend state, the SSPND flag (pin 29) is asserted. The PCM2912A wakes up immediately after detecting the non-idle state on the USB bus. Figure 35 illustrates these actions.

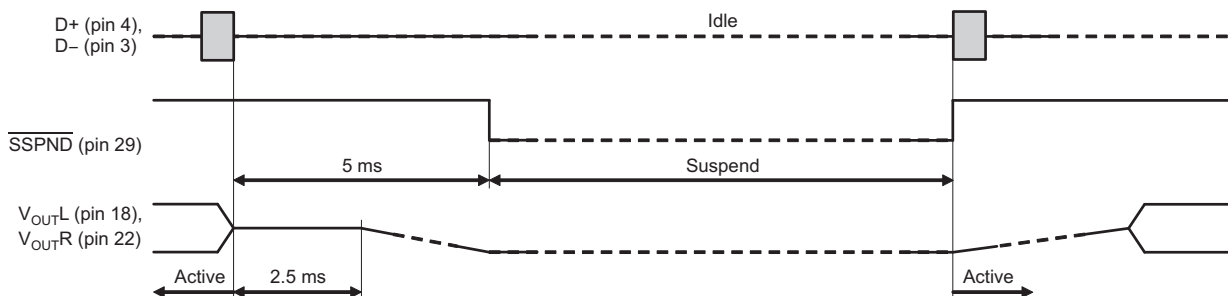

Figure 35. Suspend and Resume

## 9.4 Device Functional Modes

The PCM2912A is a USB-controlled device. The PCM2912A is a codec, with an analog input (that goes to an A/D converter) and analog output (that comes from a D/A converter), alongside the analog path that goes from the microphone input to the headphone output. A wider explanation of these operational modes is shown in [Feature Description](#).

The PCM2912A has hardware controls to turn on and off the integrated microphone preamplifier and the microphone input itself (MAMP and MMUTE, respectively); the microphone preamplifier has +20-dB fixed gain.

## 9.5 Programming

### 9.5.1 USB Interface

Control data and audio data are transferred to the PCM2912A via D+ (pin 4) and D– (pin 3). All data transferred to/from the PCM2912A are performed at full speed. [Table 1](#) summarizes the device descriptor. The device descriptor can be modified on request.

**Table 1. Device Descriptor**

DEVICE DESCRIPTOR	DESCRIPTION
USB revision	2.0 compliant
Device class	0x00 (device defined in interface level)
Device sub class	0x00 (not specified)
Device protocol	0x00 (not specified)
Maximum packet size for endpoint 0	8-byte
Vendor ID	0x08BB
Product ID	0x2912
Device release number	0x0100 (1.00)
Number of configurations	1
Vendor string	String #1 (refer to <a href="#">Table 3</a> )
Product string	String #2 (refer to <a href="#">Table 3</a> )
Serial number	Not supported

[Table 2](#) lists the configuration descriptor. The configuration descriptor can be modified on request.

**Table 2. Configuration Descriptor**

CONFIGURATION DESCRIPTOR	DESCRIPTION
Interface	Three interfaces
Power attribute	0x80 (Bus powered, no remote wakeup)
Max power	0x32 (100 mA at POWER = Low) / 0xFA (500mA at POWER = High)

[Table 3](#) summarizes the string descriptor. The string descriptor can be modified on request.

**Table 3. String Descriptor**

STRING DESCRIPTOR	DESCRIPTION
#0	0x0409
#1	Burr-Brown from TI
#2	USB audio CODEC

### 9.5.1.1 Device Configuration

Figure 36 illustrates the USB audio function topology. The PCM2912A has three interfaces. Each interface is constructed with some alternative settings.

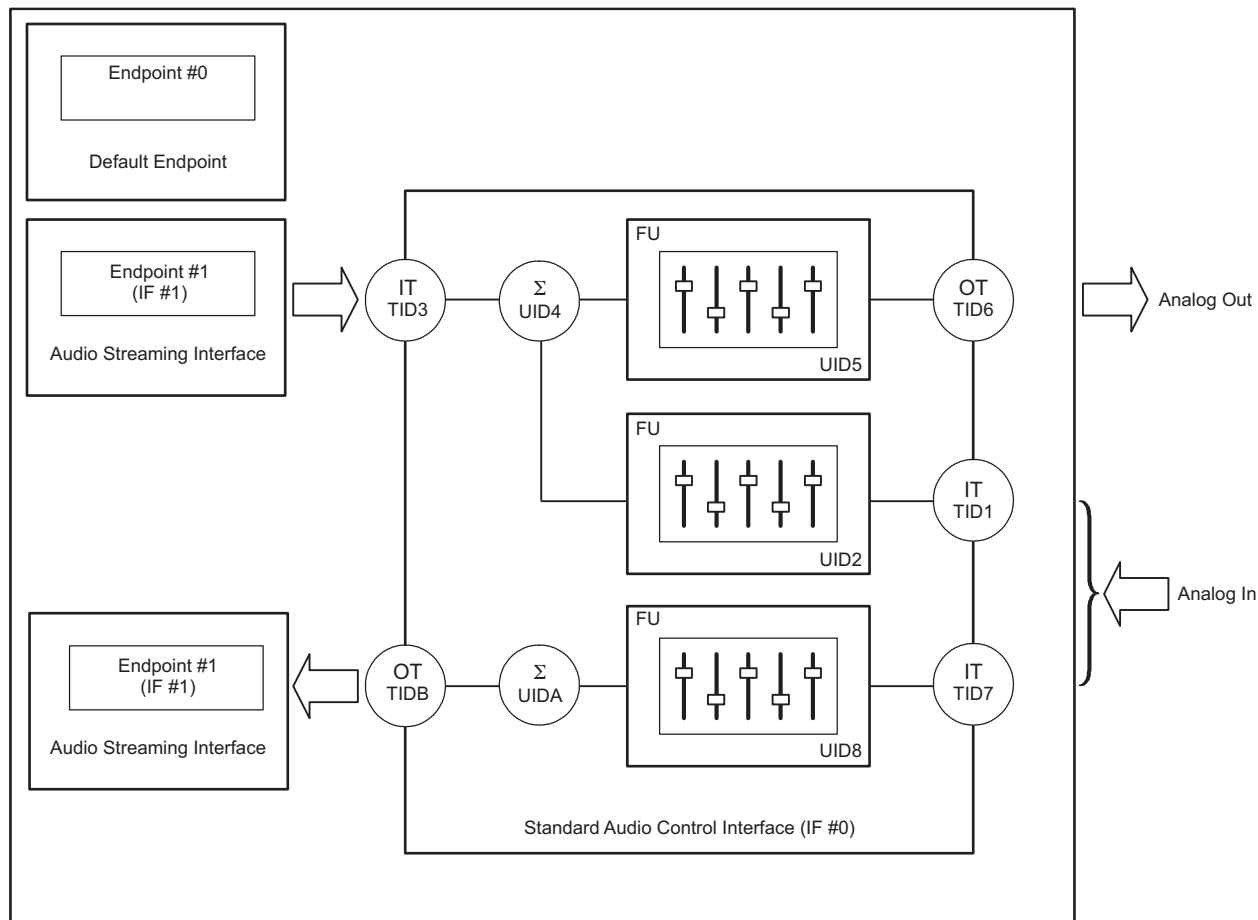

Figure 36. USB Audio Function Topology

### 9.5.1.2 Interface #0

Interface #0 is the control interface. Alternative setting #0 is the only possible setting for interface #0. Alternative setting #0 describes the standard audio control interface. The audio control interface is constructed with a series of terminal connections. The PCM2912A has the following 10 terminals:

- Input terminal (Terminal ID#1) for audio analog input for sidetone
- Feature unit (Unit ID#2) for sidetone PGA
- Input terminal (Terminal ID#3) for isochronous out stream
- Mixer unit (Unit ID#4) for sidetone mixing
- Feature unit (Unit ID#5) for analog output PGA
- Output terminal (Terminal ID#6) for audio analog output
- Input terminal (Terminal ID#7) for audio analog input
- Feature unit (Unit ID#8) for analog input PGA
- Mixer unit (Unit ID#A) for analog input
- Output terminal (Terminal ID#B) for isochronous in stream

Input terminal #3 is defined as *USB stream* (terminal type 0x0101). Input terminal #3 can accept two-channel audio streams constructed by the left and right channels. Output terminal #6 is defined as a *speaker* (terminal type 0x0301). Input terminals #1 and #7 are defined as *Microphone* (terminal type 0x0201). Physically, these two input terminals are the same input, but logically duplicated. Output terminal B is defined as a *USB stream* (terminal type 0x0101). Output terminal B is a single-channel audio stream. Mixer unit #4 multiplexes the analog input (sidetone) and the audio data of the digital-to-analog converter (DAC). Mixer unit A is placed in front of output terminal B. Mixer unit A has no impact on recording data. Mixer units #4 and A do not have programming capability.

Feature unit #5 supports the following sound control features for analog outputs:

- Volume control
- Mute control

The built-in volume controller can be manipulated by an audio-class-specific request from 0 dB to –76 dB in steps of 1 dB. An individual (L and R) channel can be set for different values. The built-in mute controller can be manipulated by an audio-class-specific request. Only the master mute control request is acceptable.

Feature unit #2 supports the following sound control features for analog input (sidetone):

- Volume control
- Mute control

The built-in volume controller can be manipulated by an audio-class-specific request from 0 dB to –76 dB in 1-dB steps. Only the master volume control is acceptable. The built-in mute controller can be manipulated by audio-class-specific request. Only the master mute control request is acceptable.

Feature unit #8 supports the following sound control features for analog input (microphone record input):

- Volume control
- Mute control

The built-in analog volume controller can be manipulated by an audio-class-specific request from +30 dB to –12 dB in 1-dB steps. The built-in mute controller can be manipulated by an audio-class-specific request. Only the master mute control request is acceptable.

### 9.5.1.3 Interface #1

Interface #1 is the audio streaming interface for data output. [Table 4](#) lists the three alternative settings for Interface #1. Alternative setting #0 is the zero bandwidth setting. All other alternative settings are operational settings.

**Table 4. Interface #1 Alternative Settings**

ALTERNATIVE SETTING	DATA FORMAT			TRANSFER MODE	SAMPLING RATE (kHz)
00	Zero Bandwidth				
01	16 bit	Stereo	2s complement (PCM)	Adaptive	8, 11.025, 16, 22.05, 32, 44.1, 48
02	16 bit	Mono	2s complement (PCM)	Adaptive	8, 11.025, 16, 22.05, 32, 44.1, 48

### 9.5.1.4 Interface #2

Interface #2 is the audio streaming interface for data output. [Table 5](#) shows the two alternative settings for Interface #2. Alternative setting #0 is the Zero Band Width setting. Alternative setting #1 is an operational setting.

**Table 5. Interface #2 Alternative Settings**

ALTERNATIVE SETTING	DATA FORMAT			TRANSFER MODE	SAMPLING RATE (kHz)
00	Zero Bandwidth				
01	16 bit	Mono	2s complement (PCM)	Asynchronous	8, 11.025, 16, 22.05, 32, 44.1, 48

### 9.5.1.5 Endpoints

The PCM2912A has the following three endpoints:

- Control endpoint (EP #0)
- Isochronous out audio data stream endpoint (EP #1)
- Isochronous in audio data stream endpoint (EP #2)

The control endpoint is the default endpoint. The control endpoint controls all functions of the PCM2912A by the standard USB request and USB audio class-specific request from the host. The isochronous out audio data stream endpoint is an audio sink endpoint, which receives the PCM audio data. The isochronous out audio data stream endpoint accepts the asynchronous transfer mode. The isochronous in audio data stream endpoint is an audio source endpoint, which transmits the PCM audio data. The isochronous in audio data stream endpoint uses synchronous transfer mode.

### 9.5.1.6 Internal Regulator

All required power sources are generated by five internal regulators.

Each regulator generates 3.3 V (typical, without load) from  $V_{BUS}$  (pin 2). Each regulator has an output pin and a ground return pin (as described in [Table 6](#)); this pair must be decoupled with an appropriate capacitor. Note that this capacitance affects inrush-current limitation. One band-gap reference circuit supplies reference voltage for all regulators. BGND (pin 1) is provided for reference ground of the band-gap reference.

**Table 6. Internal Regulator Summary**

SUPPLIED CIRCUIT	OUTPUT	RETURN
Digital	$V_{DD}$ (pin 5)	DGND (pin 6)
Analog	$V_{CCA}$ (pin 15)	AGND (pin 13)
Headphone (L-ch)	$V_{CCL}$ (pin 19)	HGND (pin 20)
Headphone (R-ch)	$V_{CCR}$ (pin 21)	HGND (pin 20)
PLL	$V_{CCP}$ (pin 26)	PGND (pin 25)

## 10 Application and Implementation

### NOTE

Information in the following applications sections is not part of the TI component specification, and TI does not warrant its accuracy or completeness. TI's customers are responsible for determining suitability of components for their purposes. Customers should validate and test their design implementation to confirm system functionality.

### 10.1 Application Information

The  $V_{BUS}$  alerts the device when it has been plugged to a USB connection port. The /SSPND flag notifies when the USB input is idle for at least 5 ms; this flag can be used to control or notify subsequent circuits. More functional details can be found in [Interface Sequence](#).

### 10.2 Typical Application

A bus-powered (Hi-power), +20-dB microphone amplifier application example is shown in [Figure 37](#).

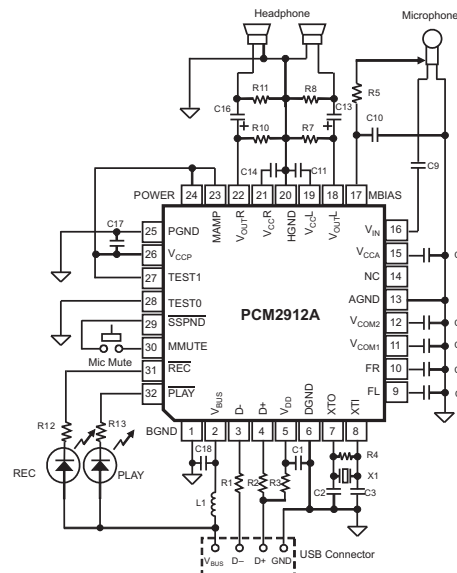

NOTE: X<sub>1</sub>: 6-MHz crystal resonator

C<sub>1</sub>, C<sub>8</sub>, C<sub>11</sub>, C<sub>14</sub>, C<sub>17</sub>, C<sub>18</sub>: 1 µF ceramic

C<sub>2</sub>, C<sub>3</sub>: 10 pF to 33 pF (depending on load capacitance of crystal resonator)

C<sub>4</sub>, C<sub>5</sub>: 100 pF ceramic

C<sub>6</sub>, C<sub>10</sub>: 3.3 µF

C<sub>7</sub>: 0.1 µF

C<sub>9</sub>: 0.22 µF electrolytic (depending on required frequency response for microphone input)

C<sub>13</sub>, C<sub>16</sub>: 100 µF electrolytic (depending on required frequency response for headphone output)

R<sub>1</sub>, R<sub>2</sub>: 22 Ω to 33 Ω

R<sub>3</sub>: 1.5 kΩ

R<sub>4</sub>: 1 MΩ

R<sub>5</sub>: 1 kΩ (depending on microphone characteristic)

R<sub>7</sub>, R<sub>8</sub>, R<sub>10</sub>, R<sub>11</sub>: 3.3 kΩ

R<sub>12</sub>, R<sub>13</sub>: 820 Ω (depending on LED drive current)

L<sub>1</sub>: 1 µH (DC resistance < 0.6 Ω)

It is possible to change maximum power if total power of actual application does not require over 100 mA (set POWER = low to configure as low-power device).

**Figure 37. USB Headset Application**



## Typical Application (continued)

### NOTE

The circuit in [Figure 37](#) is for information only. Total board design should be considered in order to meet the USB specification as a USB-compliant product.

### 10.2.1 Design Requirements

For this design example, use the parameters listed in [Table 7](#).

**Table 7. Design Parameters**

DESIGN PARAMETER	EXAMPLE VALUE
Input voltage range	4.35 V to 5.25 V
Current	80 mA to 100 mA
Input clock frequency	11.994 MHz to 12.006 MHz

### 10.2.2 Detailed Design Procedure

The PCM2912A is a simple design device, as can connect directly to a USB port. The device only requires decoupling capacitors on the voltage source pins and the output filter for the headphone amplifier; a recommended output filter is the one implemented in the PCM2912AEVM, shown in the user's guide ([SBAU141](#)).

### 10.2.3 Application Curves

For the application curves, see the graphs listed in [Table 8](#).

**Table 8. Table of Graphs**

		FIGURE
ADC Digital Decimation Filter Frequency Response	Overall Characteristic	<a href="#">Figure 1</a>
	Stop Band Attenuation	<a href="#">Figure 2</a>
	Passband Ripple	<a href="#">Figure 3</a>
	Transient Band Response	<a href="#">Figure 4</a>
ADC Digital High-Pass Filter Frequency Response	Stop Band Characteristic	<a href="#">Figure 5</a>
	Passband Characteristic	<a href="#">Figure 6</a>
ADC Analog Antialiasing Filter Frequency Response	Stop Band Characteristic	<a href="#">Figure 7</a>
	Passband Characteristic	<a href="#">Figure 8</a>
DAC Digital Interpolation Filter Frequency Response	Stop Band Attenuation	<a href="#">Figure 9</a>
	Passband Ripple	<a href="#">Figure 10</a>
	Transient Band Response	<a href="#">Figure 11</a>
DAC Analog FIR Filter Frequency Response	Stop Band Characteristic	<a href="#">Figure 12</a>
	Passband Characteristic	<a href="#">Figure 13</a>
DAC Analog Low-Pass Filter Frequency Response	Stop Band Characteristic	<a href="#">Figure 14</a>
	Passband Characteristic	<a href="#">Figure 15</a>
ADC	THD+N at – 1 dB vs Temperature	<a href="#">Figure 16</a>
	Dynamic Range and Signal-to-Noise Ratio vs Temperature	<a href="#">Figure 17</a>
	THD+N at – 1 dB vs Supply Voltage	<a href="#">Figure 18</a>
	Dynamic Range and Signal-to-Noise Ratio vs Supply Voltage	<a href="#">Figure 19</a>
	THD+N at – 1 dB vs Sampling Frequency	<a href="#">Figure 20</a>
	Dynamic Range and Signal-to-Noise Ratio vs Sampling Frequency	<a href="#">Figure 21</a>

**Table 8. Table of Graphs (continued)**

		<b>FIGURE</b>
DAC	THD+N at 0 dB vs Temperature	<a href="#">Figure 22</a>
	Dynamic Range and Signal-to-Noise Ratio vs Temperature	<a href="#">Figure 23</a>
	THD+N at 0 dB vs Supply Voltage	<a href="#">Figure 24</a>
	Dynamic Range and Signal-to-Noise Ratio vs Supply Voltage	<a href="#">Figure 25</a>
	THD+N at 0 dB vs Sampling Frequency	<a href="#">Figure 26</a>
	Dynamic Range and Signal-to-Noise Ratio vs Sampling Frequency	<a href="#">Figure 27</a>
Supply Current	Supply Current vs Supply Voltage	<a href="#">Figure 28</a>
	Supply Current vs Sampling Frequency	<a href="#">Figure 29</a>
	Supply Current vs Temperature at Suspend Mode	<a href="#">Figure 30</a>

## 11 Power Supply Recommendations

The voltage source to power the PCM2912A must be between 4.35 V and 5.25 V for proper operation (USB voltage). TI recommends placing a decoupling capacitor in every voltage source pin to help filter lower frequency power supply noise. Place these decoupling capacitors as close as possible to the PCM2912A.

## 12 Layout

### 12.1 Layout Guidelines

The decoupling capacitors must be as close as possible to the PCM2912A pins. TI recommends following the output filter for the headphone amplifier used in the PCM2912A EVM. The analog input needs a series capacitor to eliminate any possible offset level. The PCM2912A is a low-power device, thus there is no need for a special heat sink PCB design.

### 12.2 Layout Example

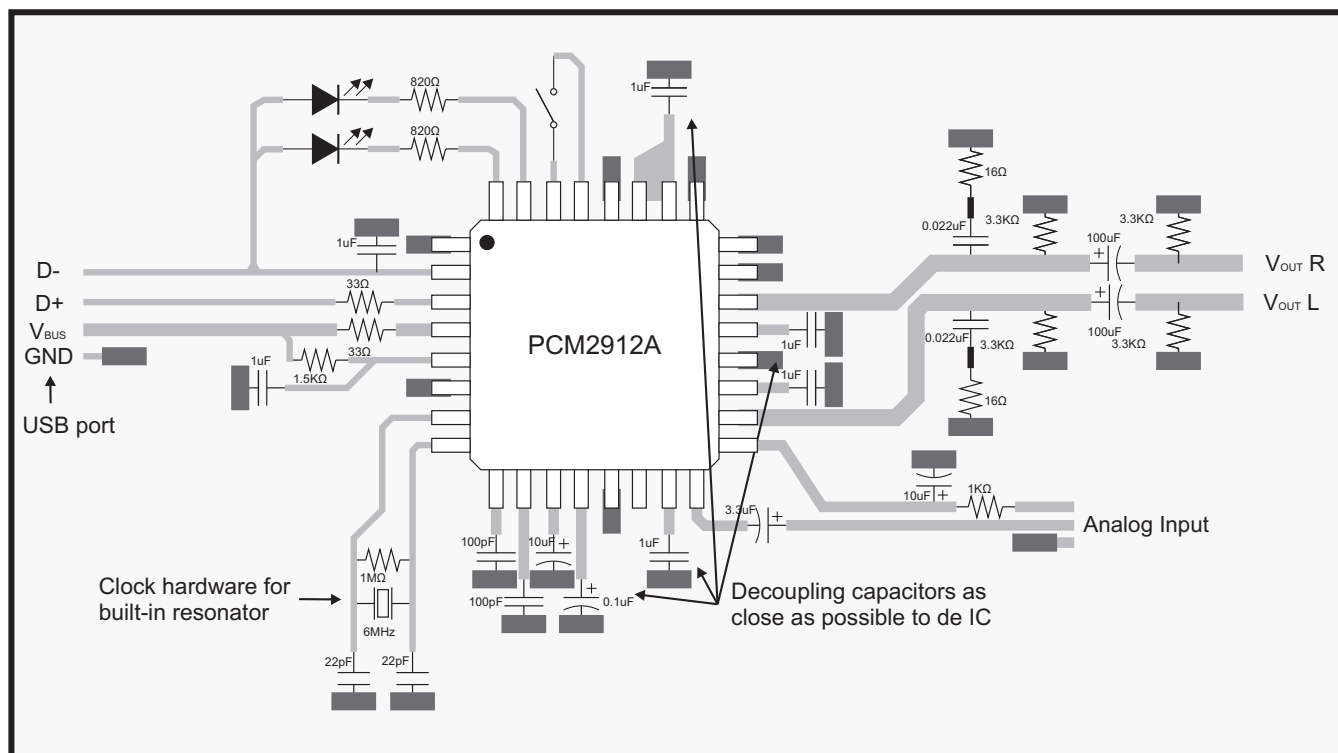

## 13 Device and Documentation Support

### 13.1 Documentation Support

#### 13.1.1 Related Documentation

For related documentation, see the following:

- *Operating Environments for PCM2912 Applications*, [SLAA387](#)
- EVM User's Guide, [SBAU141](#)

### 13.2 Community Resources

The following links connect to TI community resources. Linked contents are provided "AS IS" by the respective contributors. They do not constitute TI specifications and do not necessarily reflect TI's views; see TI's [Terms of Use](#).

**TI E2E™ Online Community** *TI's Engineer-to-Engineer (E2E) Community*. Created to foster collaboration among engineers. At [e2e.ti.com](#), you can ask questions, share knowledge, explore ideas and help solve problems with fellow engineers.

**Design Support** *TI's Design Support* Quickly find helpful E2E forums along with design support tools and contact information for technical support.

### 13.3 Trademarks

SpAct, E2E are trademarks of Texas Instruments.

Audio Precision, System Two are trademarks of Audio Precision, Inc..

All other trademarks are the property of their respective owners.

### 13.4 Electrostatic Discharge Caution



These devices have limited built-in ESD protection. The leads should be shorted together or the device placed in conductive foam during storage or handling to prevent electrostatic damage to the MOS gates.

### 13.5 Glossary

[SLYZ022](#) — *TI Glossary*.

This glossary lists and explains terms, acronyms, and definitions.

## 14 Mechanical, Packaging, and Orderable Information

The following pages include mechanical, packaging, and orderable information. This information is the most current data available for the designated devices. This data is subject to change without notice and revision of this document. For browser-based versions of this data sheet, refer to the left-hand navigation.

**PACKAGING INFORMATION**

Orderable Device	Status (1)	Package Type	Package Drawing	Pins	Package Qty	Eco Plan (2)	Lead finish/ Ball material (6)	MSL Peak Temp (3)	Op Temp (°C)	Device Marking (4/5)	Samples
PCM2912APJT	ACTIVE	TQFP	PJT	32	250	RoHS & Green	NIPDAU	Level-1-260C-UNLIM	-25 to 85	PCM2912A	<a href="#">Samples</a>
PCM2912APJTR	ACTIVE	TQFP	PJT	32	1000	RoHS & Green	NIPDAU	Level-1-260C-UNLIM	-25 to 85	PCM2912A	<a href="#">Samples</a>

(1) The marketing status values are defined as follows:

**ACTIVE:** Product device recommended for new designs.

**LIFEBUY:** TI has announced that the device will be discontinued, and a lifetime-buy period is in effect.

**NRND:** Not recommended for new designs. Device is in production to support existing customers, but TI does not recommend using this part in a new design.

**PREVIEW:** Device has been announced but is not in production. Samples may or may not be available.

**OBSOLETE:** TI has discontinued the production of the device.

(2) **RoHS:** TI defines "RoHS" to mean semiconductor products that are compliant with the current EU RoHS requirements for all 10 RoHS substances, including the requirement that RoHS substance do not exceed 0.1% by weight in homogeneous materials. Where designed to be soldered at high temperatures, "RoHS" products are suitable for use in specified lead-free processes. TI may reference these types of products as "Pb-Free".

**RoHS Exempt:** TI defines "RoHS Exempt" to mean products that contain lead but are compliant with EU RoHS pursuant to a specific EU RoHS exemption.

**Green:** TI defines "Green" to mean the content of Chlorine (Cl) and Bromine (Br) based flame retardants meet JS709B low halogen requirements of <=1000ppm threshold. Antimony trioxide based flame retardants must also meet the <=1000ppm threshold requirement.

(3) MSL, Peak Temp. - The Moisture Sensitivity Level rating according to the JEDEC industry standard classifications, and peak solder temperature.

(4) There may be additional marking, which relates to the logo, the lot trace code information, or the environmental category on the device.

(5) Multiple Device Markings will be inside parentheses. Only one Device Marking contained in parentheses and separated by a "~" will appear on a device. If a line is indented then it is a continuation of the previous line and the two combined represent the entire Device Marking for that device.

(6) Lead finish/Ball material - Orderable Devices may have multiple material finish options. Finish options are separated by a vertical ruled line. Lead finish/Ball material values may wrap to two lines if the finish value exceeds the maximum column width.

**Important Information and Disclaimer:**The information provided on this page represents TI's knowledge and belief as of the date that it is provided. TI bases its knowledge and belief on information provided by third parties, and makes no representation or warranty as to the accuracy of such information. Efforts are underway to better integrate information from third parties. TI has taken and continues to take reasonable steps to provide representative and accurate information but may not have conducted destructive testing or chemical analysis on incoming materials and chemicals. TI and TI suppliers consider certain information to be proprietary, and thus CAS numbers and other limited information may not be available for release.

In no event shall TI's liability arising out of such information exceed the total purchase price of the TI part(s) at issue in this document sold by TI to Customer on an annual basis.



**TAPE AND REEL INFORMATION**

**QUADRANT ASSIGNMENTS FOR PIN 1 ORIENTATION IN TAPE**

\*All dimensions are nominal

Device	Package Type	Package Drawing	Pins	SPQ	Reel Diameter (mm)	Reel Width W1 (mm)	A0 (mm)	B0 (mm)	K0 (mm)	P1 (mm)	W (mm)	Pin1 Quadrant
PCM2912APJTR	TQFP	PJT	32	1000	330.0	16.4	9.6	9.6	1.5	12.0	16.0	Q2

**TAPE AND REEL BOX DIMENSIONS**

\*All dimensions are nominal

Device	Package Type	Package Drawing	Pins	SPQ	Length (mm)	Width (mm)	Height (mm)
PCM2912APJTR	TQFP	PJT	32	1000	350.0	350.0	43.0



**TRAY**

Chamfer on Tray corner indicates Pin 1 orientation of packed units.

\*All dimensions are nominal

Device	Package Name	Package Type	Pins	SPQ	Unit array matrix	Max temperature (°C)	L (mm)	W (mm)	K0 (µm)	P1 (mm)	CL (mm)	CW (mm)
PCM2912APJT	PJT	TQFP	32	250	10 x 25	150	315	135.9	7620	12.2	11.1	11.25

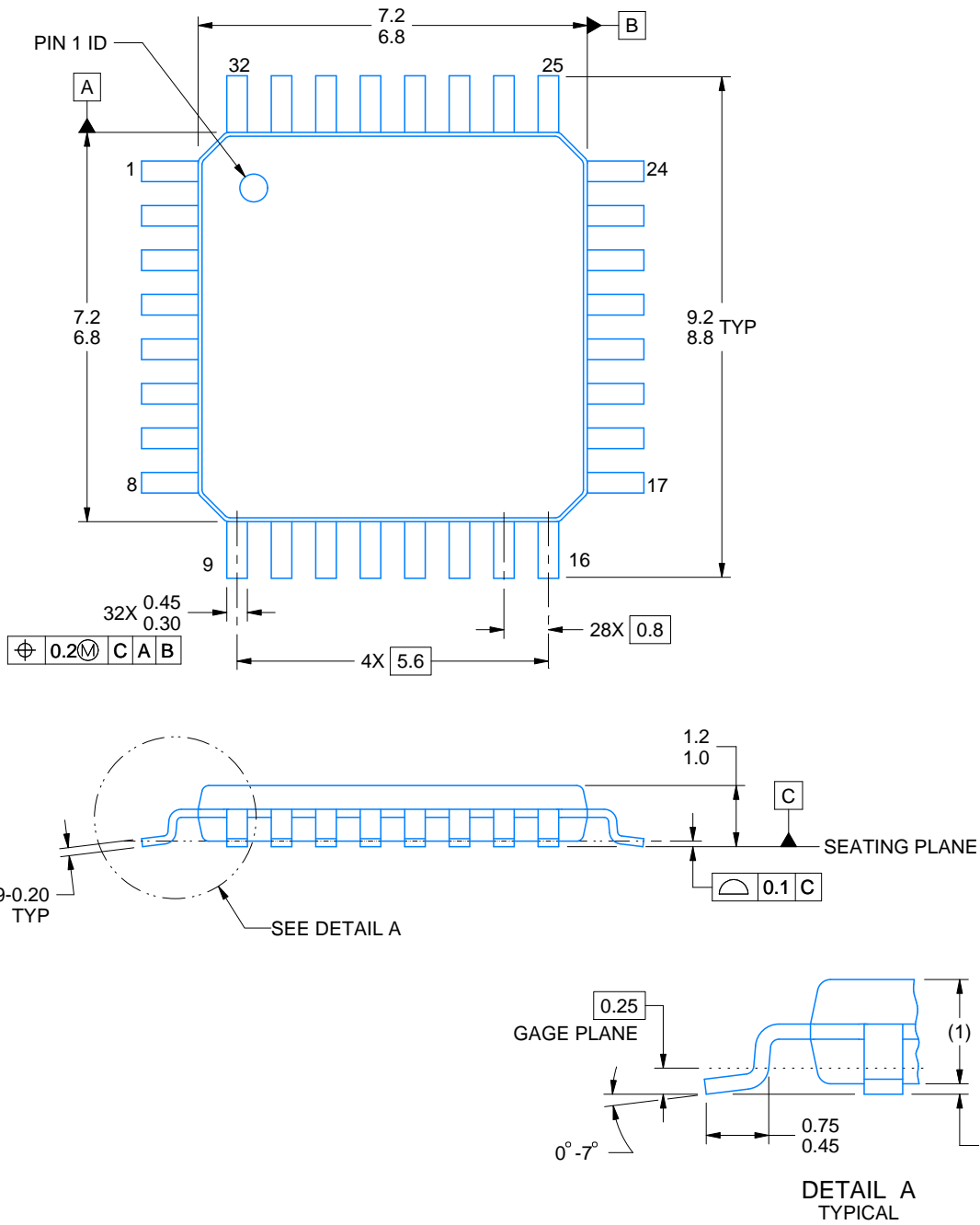
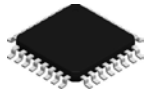

4220861/A 07/2023

NOTES:

1. All linear dimensions are in millimeters. Any dimensions in parenthesis are for reference only. Dimensioning and tolerancing per ASME Y14.5M.
2. This drawing is subject to change without notice.
3. Reference JEDEC registration MS-026.

# EXAMPLE BOARD LAYOUT

PJT0032A

TQFP - 1.2 mm max height

PLASTIC QUAD FLATPACK

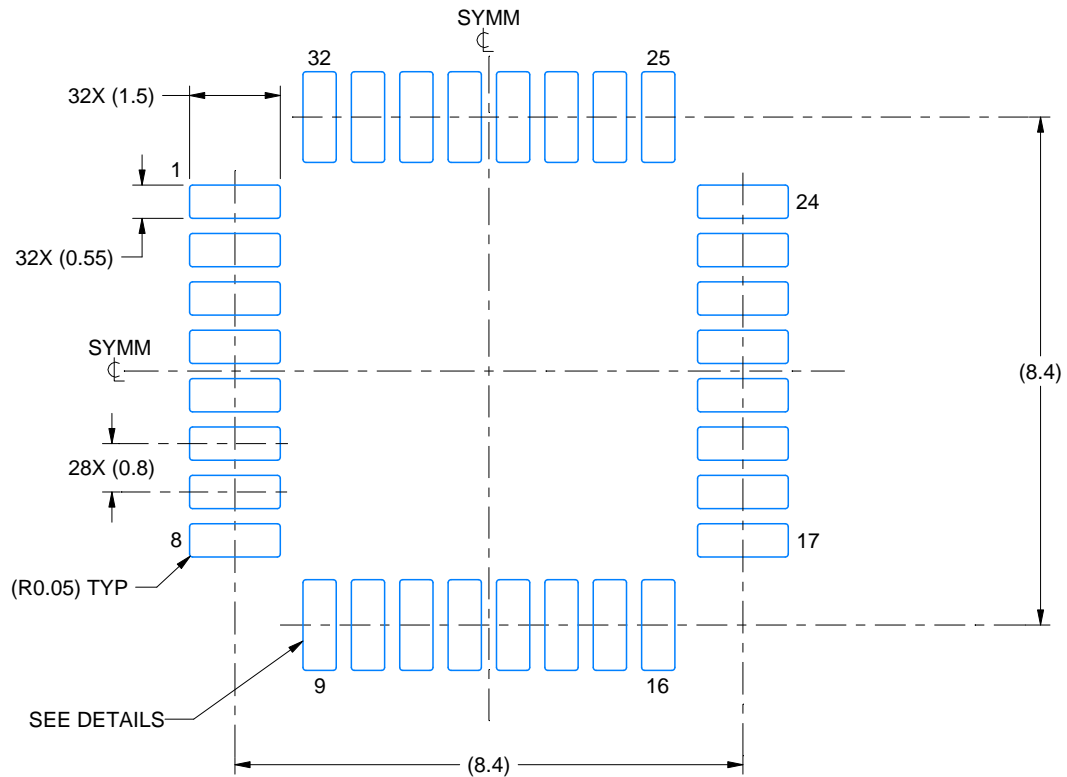

LAND PATTERN EXAMPLE  
EXPOSED METAL SHOWN  
SCALE:8X

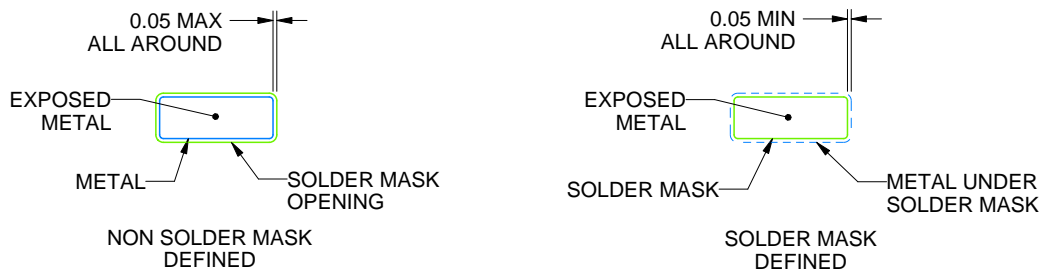

SOLDER MASK DETAILS

4220861/A 07/2023

NOTES: (continued)

4. Publication IPC-7351 may have alternate designs.
5. Solder mask tolerances between and around signal pads can vary based on board fabrication site.

# EXAMPLE STENCIL DESIGN

PJT0032A

TQFP - 1.2 mm max height

PLASTIC QUAD FLATPACK

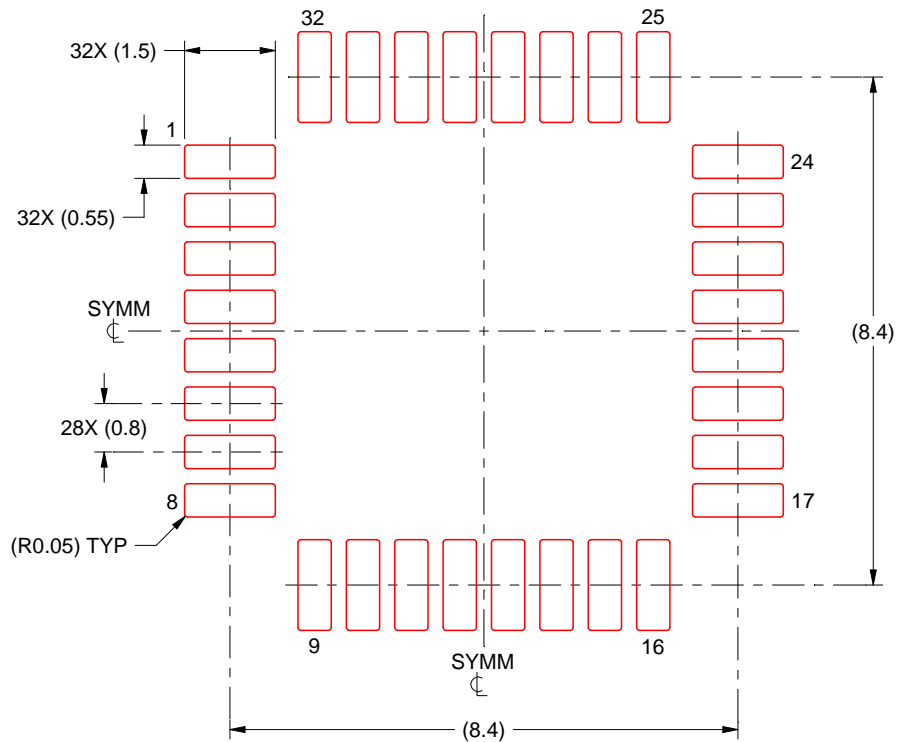

SOLDER PASTE EXAMPLE  
BASED ON 0.125 mm THICK STENCIL  
SCALE:8X

4220861/A 07/2023

NOTES: (continued)

6. Laser cutting apertures with trapezoidal walls and rounded corners may offer better paste release. IPC-7525 may have alternate design recommendations.
7. Board assembly site may have different recommendations for stencil design.

## IMPORTANT NOTICE AND DISCLAIMER

TI PROVIDES TECHNICAL AND RELIABILITY DATA (INCLUDING DATA SHEETS), DESIGN RESOURCES (INCLUDING REFERENCE DESIGNS), APPLICATION OR OTHER DESIGN ADVICE, WEB TOOLS, SAFETY INFORMATION, AND OTHER RESOURCES "AS IS" AND WITH ALL FAULTS, AND DISCLAIMS ALL WARRANTIES, EXPRESS AND IMPLIED, INCLUDING WITHOUT LIMITATION ANY IMPLIED WARRANTIES OF MERCHANTABILITY, FITNESS FOR A PARTICULAR PURPOSE OR NON-INFRINGEMENT OF THIRD PARTY INTELLECTUAL PROPERTY RIGHTS.

These resources are intended for skilled developers designing with TI products. You are solely responsible for (1) selecting the appropriate TI products for your application, (2) designing, validating and testing your application, and (3) ensuring your application meets applicable standards, and any other safety, security, regulatory or other requirements.

These resources are subject to change without notice. TI grants you permission to use these resources only for development of an application that uses the TI products described in the resource. Other reproduction and display of these resources is prohibited. No license is granted to any other TI intellectual property right or to any third party intellectual property right. TI disclaims responsibility for, and you will fully indemnify TI and its representatives against, any claims, damages, costs, losses, and liabilities arising out of your use of these resources.

TI's products are provided subject to [TI's Terms of Sale](#) or other applicable terms available either on [ti.com](https://www.ti.com) or provided in conjunction with such TI products. TI's provision of these resources does not expand or otherwise alter TI's applicable warranties or warranty disclaimers for TI products.

TI objects to and rejects any additional or different terms you may have proposed.

Mailing Address: Texas Instruments, Post Office Box 655303, Dallas, Texas 75265  
Copyright © 2023, Texas Instruments Incorporated