

Features

- Zero reverse recovery current
- Zero forward recovery voltage
- Temperature independent switching behavior
- High temperature operation
- High frequency operation

V_{RRM}	1200V
$I_F (T_c = 150.5^\circ\text{C})$	15A*
Q_c	80nC*

Benefits

- Unipolar rectifier
- Substantially reduced switching losses
- No thermal run-away with parallel devices
- Reduced heat sink requirements

Applications

- SMPS, PFC
- Solar application, UPS, EV/HEV
- Motor drives, Wind turbine, Rail traction

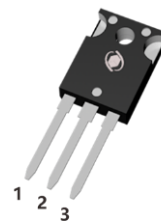

TO-247AB

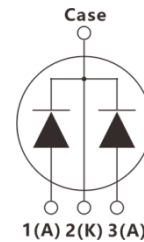

Inner Circuit

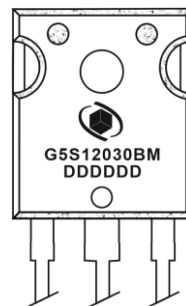

G = GPT
5 = Gen5
S = SiC Schottky Diode
120 = Voltage Rating 1200V
30 = Current Rating 30A
BM = TO-247AB
DDDDDD = Traceable Code



* Per leg **Per device

Maximum Ratings (at $T_j = 25^\circ\text{C}$, unless otherwise specified)

Parameter	Symbol	Value	Unit
Repetitive Peak Reverse Voltage	V_{RRM}	1200	V
Surge Peak Reverse Voltage	V_{RSM}	1200	V
Continuous Forward Current $T_c = 25^\circ\text{C}$ $T_c = 135^\circ\text{C}$ $T_c = 150.5^\circ\text{C}$	I_F	42.6* 20.2* 15*	A
Repetitive Peak Forward Surge Current $T_c = 25^\circ\text{C}$, $t_p = 10\text{ms}$, Half Sine Pulse	I_{FRM}	75*	A
Non-Repetitive Forward Surge Current $T_c = 25^\circ\text{C}$, $t_p = 10\text{ms}$, Half Sine Pulse	I_{FSM}	165*	A
i^2t Value $T_c = 25^\circ\text{C}$, $t_p = 10\text{ms}$, Half Sine Pulse	$\int i^2 dt$	136*	A^2s
Power Dissipation $T_c = 25^\circ\text{C}$ $T_c = 110^\circ\text{C}$	P_{tot}	181* 78*	W
Operating Junction Range	T_j	-55 to +175	$^\circ\text{C}$
Storage Temperature Range	T_{stg}	-55 to +175	$^\circ\text{C}$
Mounting Torque, M3 Screw	M	1	Nm

* Per leg; **Per device

Electrical Characteristics (at $T_J = 25^\circ\text{C}$, unless otherwise specified, Per leg)

Parameter	Symbol	Test Condition	Value			Unit
			min.	typ.	max.	
DC Blocking Voltage	V_{DC}		1200	-	-	V
Forward Voltage	V_F	$I_F = 15\text{A}$				
		$T_J = 25^\circ\text{C}$	-	1.4	1.7	V
		$T_J = 175^\circ\text{C}$	-	1.95	2.5	
Reverse Current	I_R	$V_R = 1200\text{V}$				
		$T_J = 25^\circ\text{C}$	-	5.5	50	μA
		$T_J = 175^\circ\text{C}$	-	32	100	
Total Capacitance	C	$f = 1\text{MHz}$				
		$V_R = 0\text{V}$	-	1246	-	pF
		$V_R = 400\text{V}$	-	74.6	-	
		$V_R = 800\text{V}$	-	63	-	
Total Capacitive Charge	Q_C	$V_R = 800\text{V}$ $T_J = 25^\circ\text{C}$	-	80	-	nC
Capacitance Stored Energy	E_C	$V_R = 800\text{V}$	-	41	-	μJ

Thermal Characteristics

Parameter	Symbol	Test Condition	Value			Unit
			min.	typ.	max.	
Thermal Resistance, junction-case	$R_{th(j-c)}$		-	0.83* 0.415**	-	$^\circ\text{C/W}$

* Per leg **Per device



Typical Characteristics Curves (Per leg)

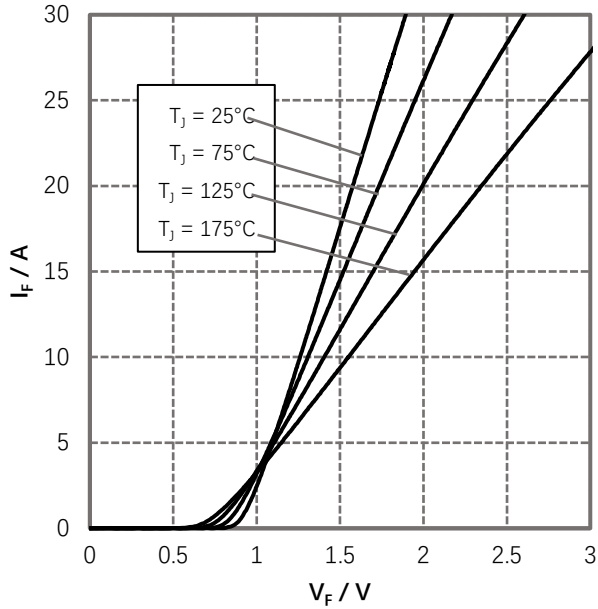

Figure 1. Forward Characteristics

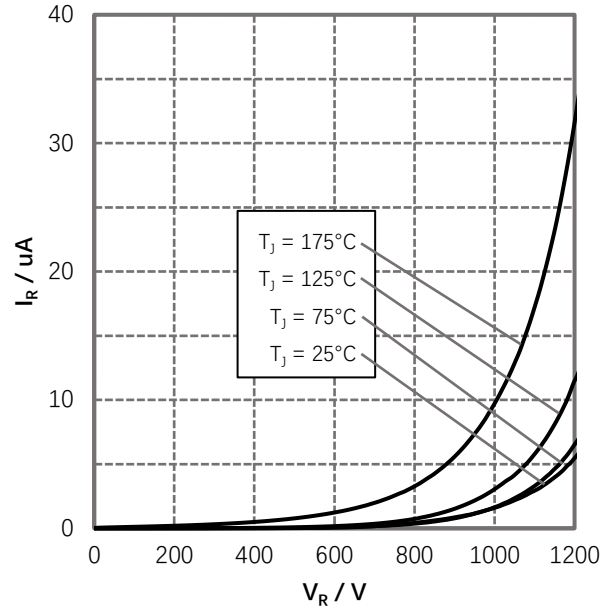

Figure 2. Reverse Characteristics

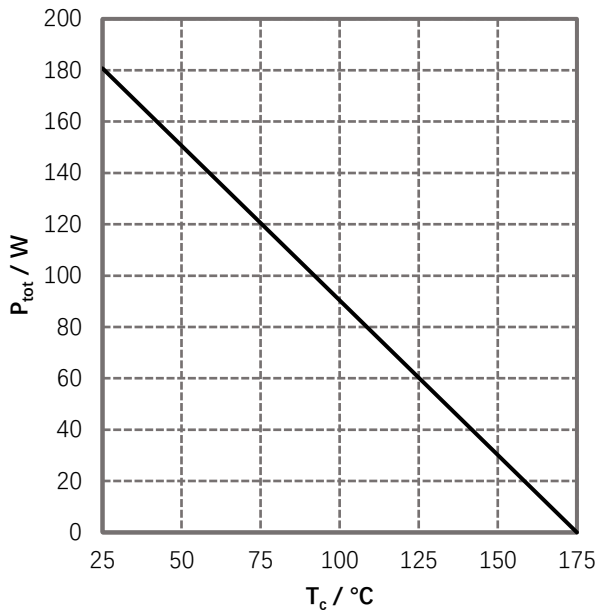

Figure 3. Power Derating

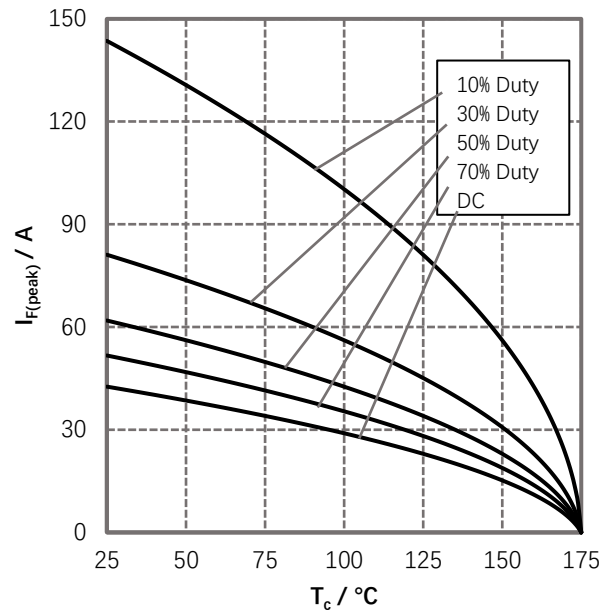

Figure 4. Current Derating

Typical Characteristics Curves (Per leg)

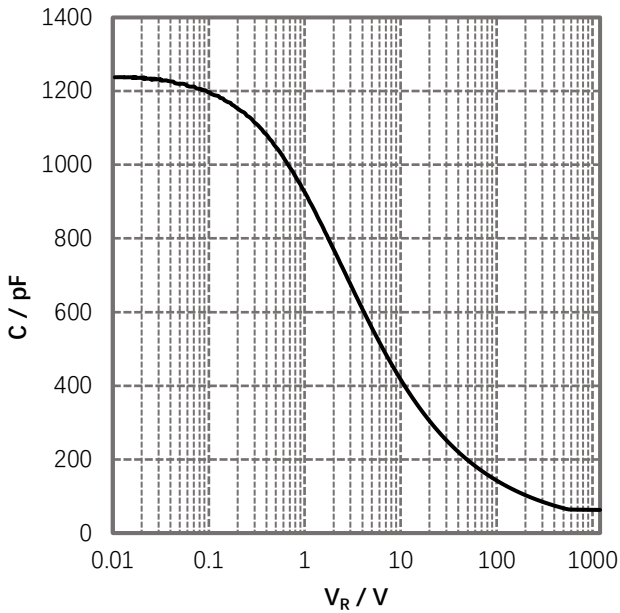

Figure 5. Capacitance vs. Reverse Voltage

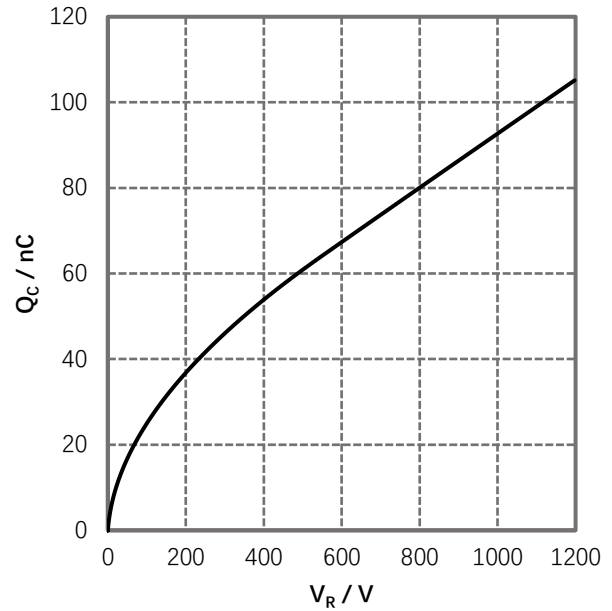

Figure 6. Reverse Charge vs. Reverse Voltage

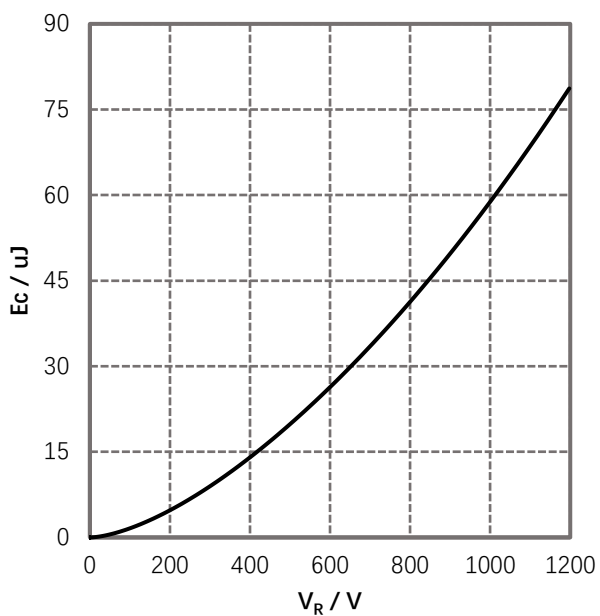

Figure 7. Capacitance Stored Energy

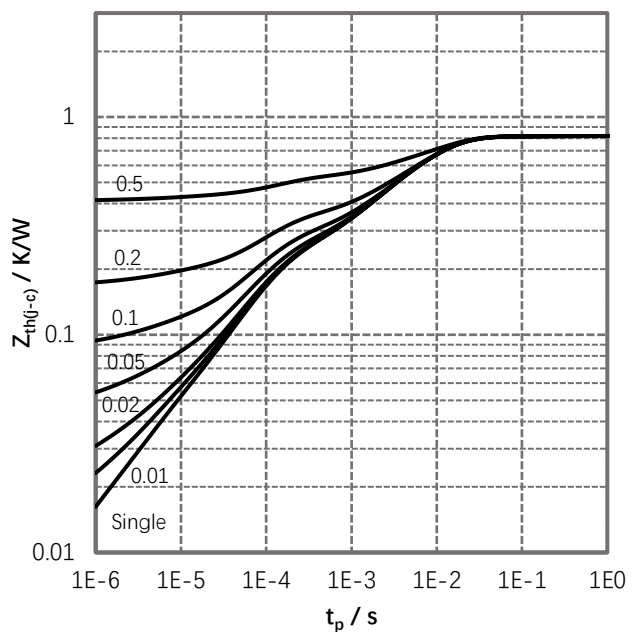
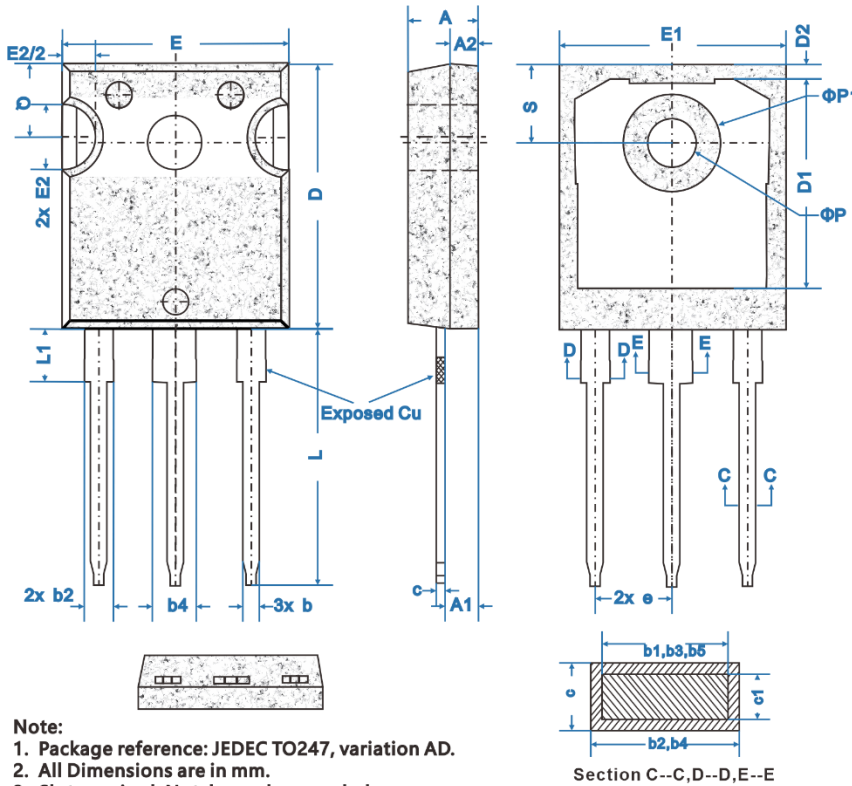

Figure 8. Transient Thermal Impedance



Package Dimensions



Note:

1. Package reference: JEDEC TO247, variation AD.
2. All Dimensions are in mm.
3. Slot required, Notch may be rounded.
4. Dimension D & E do not include Mold Flash. Mold Flash shall not exceed 0.127mm per side. These dimension are measured at the outermost extreme of the Plastic Body.
5. Thermal Pad contour optional within dimension D1 & E1.
6. Lead finish uncontrolled in L1.
7. ΦP to have a maximum draft angle of 1.5° to the top of the part with a maximum hole diameter of 3.19mm.
8. Dimension "b2" and "b4" does not include Dambar Protrusion. Allowable Dambar protrusion shall be 0.10mm total in excess of "b2" and "b4" dimension at maximum material condition.

Unit: mm

Symbol	Dimensions			Notes
	Min.	NOM.	Max.	
A	4.83	5.02	5.21	
A1	2.29	2.41	2.55	
A2	1.50	2.00	2.49	
b	1.12	1.20	1.33	
b1	1.12	1.20	1.28	
b2	1.91	2.00	2.39	6
b3	1.91	2.00	2.34	
b4	2.87	3.00	3.18	6,8
b5	2.87	3.00	3.22	
c	0.55	0.60	0.69	6
c1	0.55	0.60	0.65	
D	20.80	20.95	21.10	4
D1	16.25	16.55	17.65	5
D2	0.51	1.19	1.35	
E	15.75	15.94	16.13	4
E1	13.46	14.02	14.16	5
E2	4.32	4.91	5.49	3
e	5.44 BSC			
L	19.81	20.07	20.32	
L1	4.10	4.19	4.40	6
ΦP	3.58	3.61	3.65	7
ΦP1	7.19 Ref.			
Q	5.39	5.79	6.2	
S	6.04	6.17	6.3	

Ordering Information

Part Number	Marking	Package	Packaging Mode
G5S12030BM	G5S12030BM	TO-247AB	30pcs/Tube

Notes

- Global Power Technology reserves the right to change or modify any of the products and their inherent physical and technical specifications without prior notice.
- The information given in this document shall in no event be regarded as a guarantee of conditions or characteristics.

Related Links

- Global Power Technology Website: <http://www.globalpowertech.cn/>
- GPT online store is now open! you can place an order directly online, buy it easily, and send it directly from the factory! For more detailed product, price information and coupon activities, please log in to GPT online store: <http://sc.globalpowertech.cn/>

