

Snubberless™ high temperature 30 A Triacs

Features

- High current Triac
- High immunity level
- Low thermal resistance with clip bonding
- RoHS (2002/95/EC) compliant package
- Very high commutation (3Q) at 150 °C capability
- UL certified (ref. file E81734)

Applications

Thanks to its high electrical noise immunity level and its strong current robustness, the T30xxH series is designed for the control of AC actuators in appliances and industrial systems.

Description

Specifically designed to operate at 150 °C, the new 30 A T30xxH Triacs provide very high dynamic performance and enhanced performance in terms of power loss and thermal dissipation. This allows optimizing the heatsink size, leading to space and cost effectiveness when compared to electro-mechanical solutions.

Based on ST Snubberless™ technology, they offer a specified minimal commutation and high noise immunity levels valid up to the T_j max.

The T30xxH series optimize safely the control of universal motors and of inductive loads found in power tools and major appliances.

By using an internal ceramic pad, the T30xxH-6I provides voltage insulation (rated at 2500 V rms).

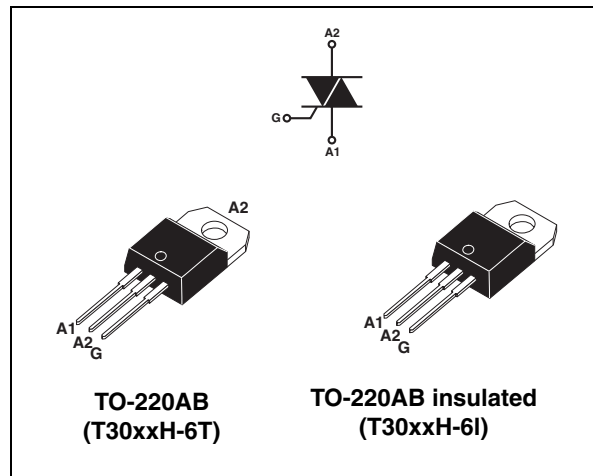

Table 1. Device summary

Symbol	Value
$I_{T(rms)}$	30 A
V_{DRM}/V_{RRM}	600 V
I_{GT}	35 or 50 mA

TM: Snubberless is a trademark of STMicroelectronics

1 Characteristics

Table 2. Absolute maximum rating

Symbol	Parameter		Value	Unit	
$I_{T(RMS)}$	On-state rms current (full sine wave)	TO-220AB	$T_c = 121\text{ °C}$	30	A
		TO-220AB insul.	$T_c = 92\text{ °C}$		
I_{TSM}	Non repetitive surge peak on-state current (full cycle, T_j initial = 25 °C)	F = 50 Hz	t = 20 ms	270	A
		F = 60 Hz	t = 16.7 ms	284	
I^2t	I^2t Value for fusing	$t_p = 10\text{ ms}$		487	A ² s
dI/dt	Critical rate of rise of on-state current $I_G = 2 \times I_{GT}$, $t_r \leq 100\text{ ns}$	F = 120 Hz	$T_j = 150\text{ °C}$	50	A/ μ s
V_{DSM}/V_{RSM}	Non repetitive surge peak off-state volt-age	$t_p = 10\text{ }\mu$ s	$T_j = 25\text{ °C}$	$V_{DSM}/V_{RSM} + 100$	V
I_{GM}	Peak gate current	$t_p = 20\text{ }\mu$ s	$T_j = 150\text{ °C}$	4	A
$P_{G(AV)}$	Average gate power dissipation	$T_j = 150\text{ °C}$		1	W
T_{stg} T_j	Storage junction temperature range Operating junction temperature range			-40 to +150 -40 to +150	°C

Table 3. Electrical characteristics ($T_j = 25\text{ °C}$, unless otherwise specified)

Symbol	Test conditions	Quadrant		Value		Unit
				T3035H	T3050H	
$I_{GT}^{(1)}$	$V_D = 12\text{ V}$ $R_L = 33\text{ }\Omega$	I - II - III	MAX.	35	50	mA
V_{GT}		I - II - III	MAX.	1.0		V
V_{GD}	$V_D = V_{DRM}$ $R_L = 3.3\text{ k}\Omega$	I - II - III	MIN.	0.15		V
$I_H^{(2)}$	$I_T = 500\text{ mA}$		MAX.	60	75	mA
I_L	$I_G = 1.2 I_{GT}$	I - III	MAX.	75	90	mA
		II		90	110	
dV/dt ⁽²⁾	$V_D = 67\% V_{DRM}$ gate open	$T_j = 150\text{ °C}$	MIN.	1000	1500	V/ μ s
(dI/dt) _c ⁽²⁾	Without snubber	$T_j = 150\text{ °C}$	MIN.	33	44	A/ms

1. Minimum I_{GT} is guaranteed at 20 % of I_{GT} max.

2. For both polarities of A2 referenced to A1.

Table 4. Static characteristics

Symbol	Test conditions			Value	Unit	
$V_{TM}^{(1)}$	$I_{TM} = 42\text{ A}$	$t_p = 380\ \mu\text{s}$	$T_j = 25\text{ }^\circ\text{C}$	MAX.	1.55	V
$V_{to}^{(1)}$	Threshold voltage		$T_j = 150\text{ }^\circ\text{C}$	MAX.	0.85	V
$R_d^{(1)}$	Dynamic resistance		$T_j = 150\text{ }^\circ\text{C}$	MAX.	15	m Ω
I_{DRM}	$V_{DRM} = V_{RRM}$		$T_j = 25\text{ }^\circ\text{C}$	MAX.	10	μA
			$T_j = 150\text{ }^\circ\text{C}$		8.5	mA
I_{RRM}	$V_D/V_R = 400\text{V}$ (at peak mains voltage)		$T_j = 150\text{ }^\circ\text{C}$	MAX.	7	
	$V_D/V_R = 200\text{V}$ (at peak mains voltage)		$T_j = 150\text{ }^\circ\text{C}$		5.5	

1. for both polarities of A2 referenced to A1.

Table 5. Thermal resistance

Symbol	Parameter		Value	Unit
$R_{th(j-c)}$	Junction to case (AC)	TO-220AB	0.8	$^\circ\text{C/W}$
		TO-220AB Insul	1.6	
$R_{th(j-a)}$	Junction to ambient	TO-220AB / TO-220AB Insul	60	$^\circ\text{C/W}$

Figure 1. Maximum power dissipation versus rms on-state current (full cycle 180°)

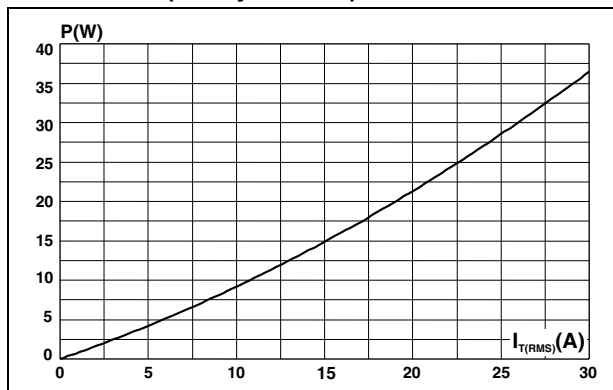

Figure 2. On-state rms current vs case temperature

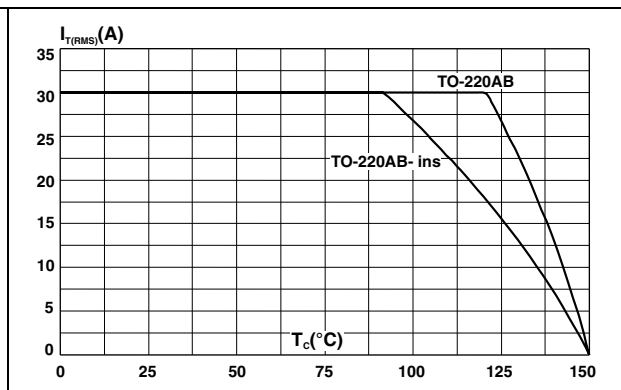

Figure 3. On-state rms current versus ambient temperature (free air convection)

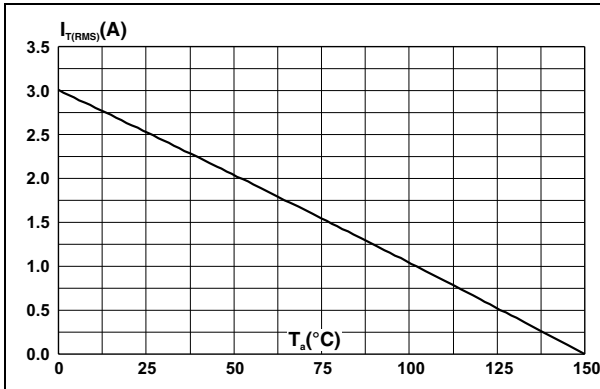

Figure 4. Relative variation of thermal impedance versus pulse duration

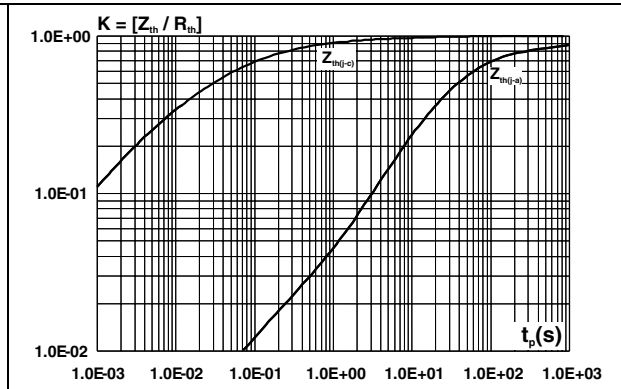

Figure 5. Relative variation of gate trigger current and gate trigger voltage versus junction temperature

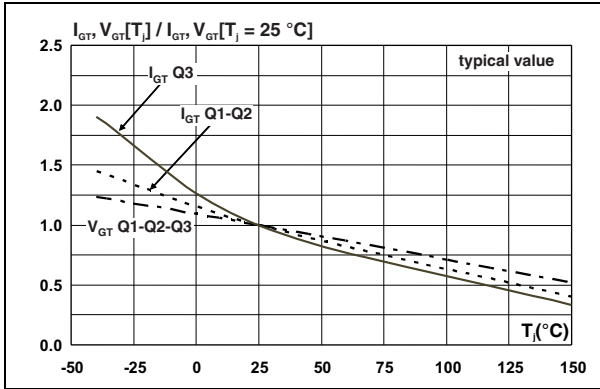

Figure 6. Relative variation of holding current and latching current vs junction temperature (typical value)

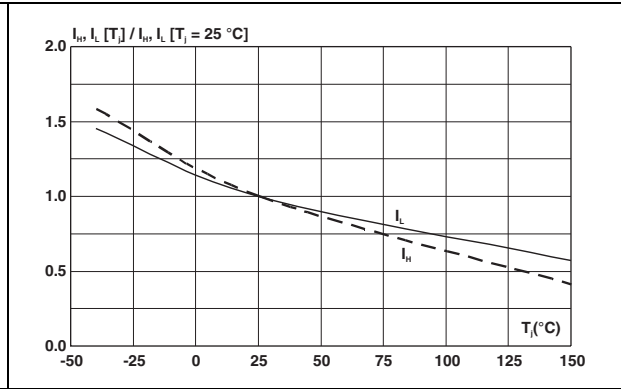

Figure 7. Surge peak on-state current vs number of cycles

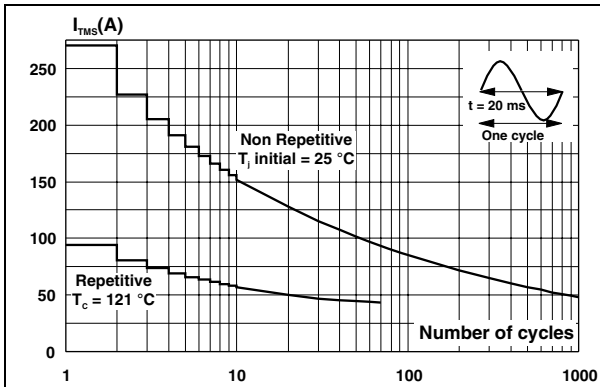

Figure 8. Non repetitive surge peak on-state current for a sinusoidal pulse

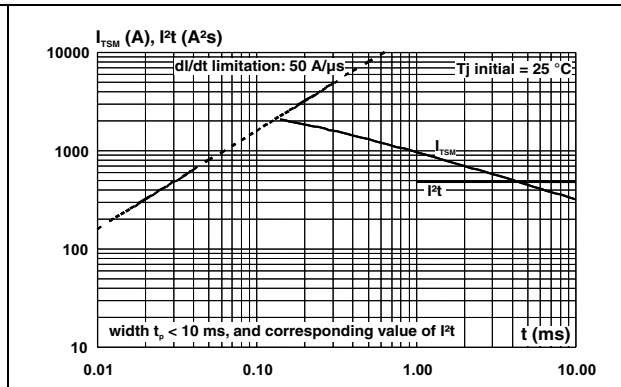

Figure 9. On state characteristics (maximum values)

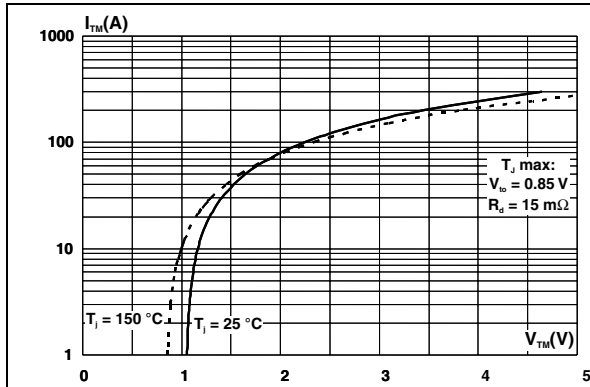

Figure 10. Relative variation of critical rate of decrease of main current vs junction temperature

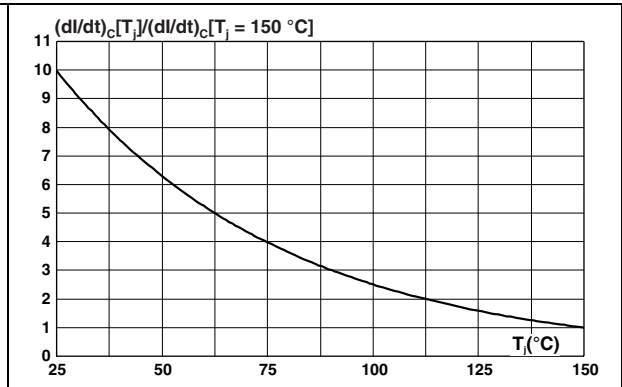

Figure 11. Relative variation of static dV/dt immunity vs junction temperature

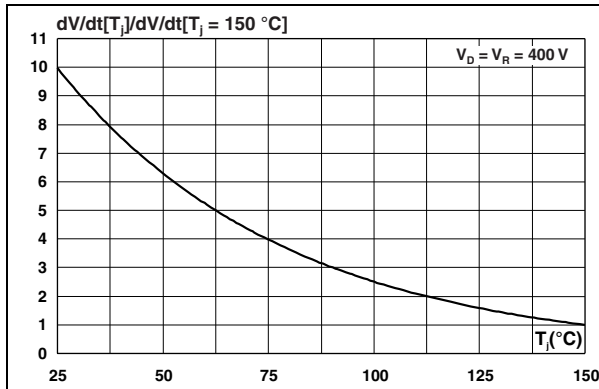

Figure 12. Relative variation of leakage current vs junction temperature for different values of blocking voltage

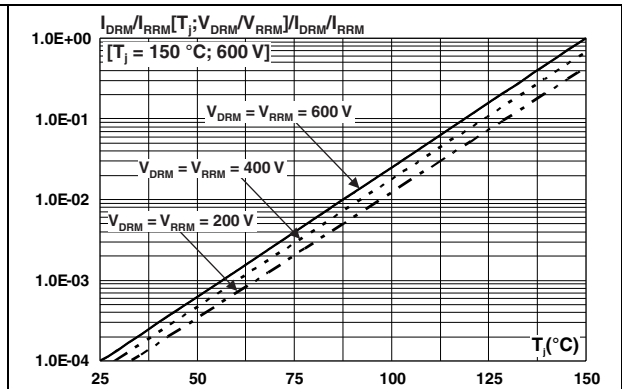
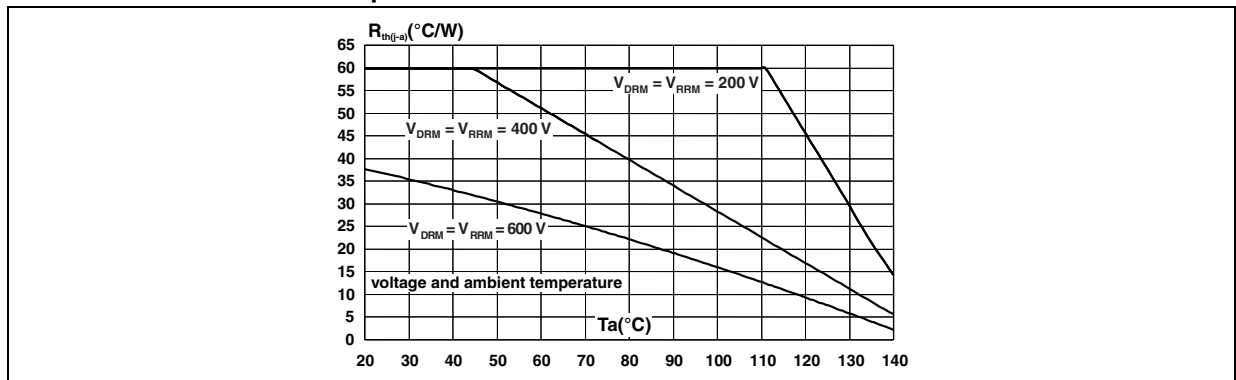

Figure 13. Acceptable junction to ambient thermal resistance vs repetitive peak off-state voltage and ambient temperature



2 Package information

- Epoxy meets UL94, V0
- Recommended torque value: 0.4 to 0.6 N-m

In order to meet environmental requirements, ST offers these devices in different grades of ECOPACK® packages, depending on their level of environmental compliance. ECOPACK® specifications, grade definitions and product status are available at: www.st.com. ECOPACK® is an ST trademark.

Table 6. TO-220AB (NIns. and Ins. 20-up) dimensions

Ref.	Dimensions					
	Millimeters			Inches		
	Min.	Typ.	Max.	Min.	Typ.	Max.
A	15.20		15.90	0.598		0.625
a1		3.75			0.147	
a2	13.00		14.00	0.511		0.551
B	10.00		10.40	0.393		0.409
b1	0.61		0.88	0.024		0.034
b2	1.23		1.32	0.048		0.051
C	4.40		4.60	0.173		0.181
c1	0.49		0.70	0.019		0.027
c2	2.40		2.72	0.094		0.107
e	2.40		2.70	0.094		0.106
F	6.20		6.60	0.244		0.259
ØI	3.75		3.85	0.147		0.151
I4	15.80	16.40	16.80	0.622	0.646	0.661
L	2.65		2.95	0.104		0.116
I2	1.14		1.70	0.044		0.066
I3	1.14		1.70	0.044		0.066
M		2.60			0.102	

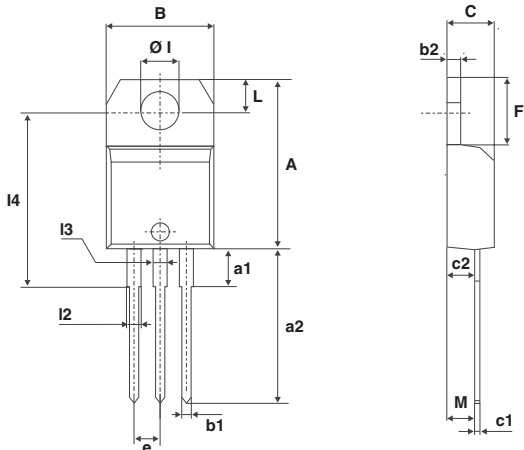

3 Ordering information scheme

Figure 14. Ordering information scheme

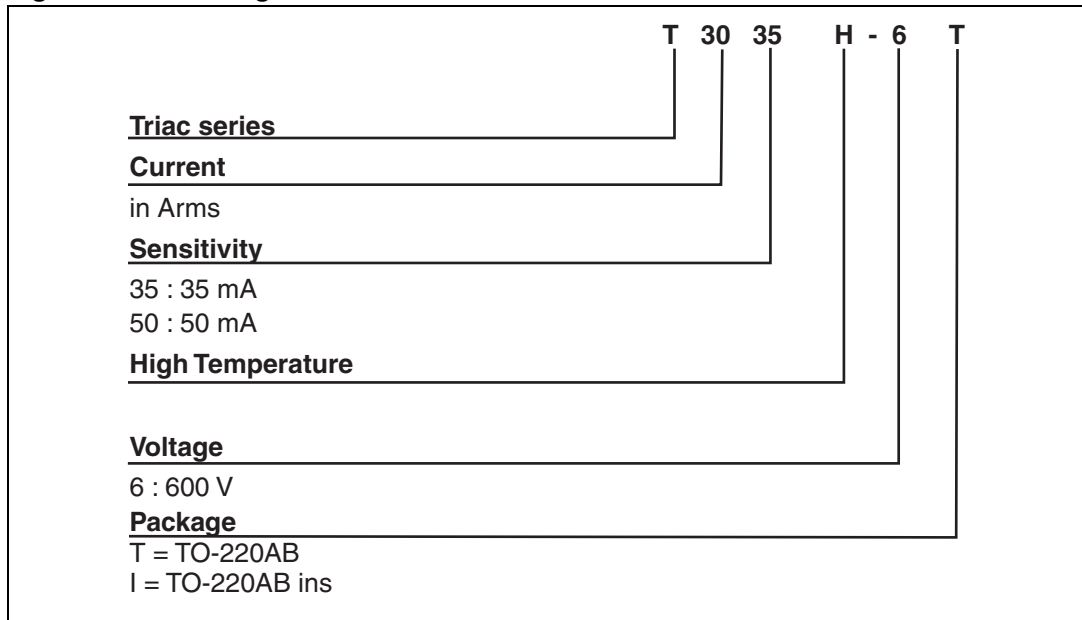

4 Ordering information

Table 7. Ordering information

Order code	Marking	Package	Weight	Base qty	Delivery mode
T3035H-6T	T3035H 6T	TO-220AB	2.3 g	50	Tube
T3050H-6T	T3050H 6T				
T3035H-6I	T3035H 6I	TO-220AB Insulated			
T3050H-6I	T3050H 6I				

5 Revision history

Table 8. Document revision history

Date	Revision	Changes
28-Jan-2010	1	Initial release.
17-May-2010	2	Updated maximum T_j in Table 2 .
14-Dec-2010	3	Updated I_{GT} in Table 1 .
20-Sep-2011	4	Updated: Features .

Please Read Carefully:

Information in this document is provided solely in connection with ST products. STMicroelectronics NV and its subsidiaries ("ST") reserve the right to make changes, corrections, modifications or improvements, to this document, and the products and services described herein at any time, without notice.

All ST products are sold pursuant to ST's terms and conditions of sale.

Purchasers are solely responsible for the choice, selection and use of the ST products and services described herein, and ST assumes no liability whatsoever relating to the choice, selection or use of the ST products and services described herein.

No license, express or implied, by estoppel or otherwise, to any intellectual property rights is granted under this document. If any part of this document refers to any third party products or services it shall not be deemed a license grant by ST for the use of such third party products or services, or any intellectual property contained therein or considered as a warranty covering the use in any manner whatsoever of such third party products or services or any intellectual property contained therein.

UNLESS OTHERWISE SET FORTH IN ST'S TERMS AND CONDITIONS OF SALE ST DISCLAIMS ANY EXPRESS OR IMPLIED WARRANTY WITH RESPECT TO THE USE AND/OR SALE OF ST PRODUCTS INCLUDING WITHOUT LIMITATION IMPLIED WARRANTIES OF MERCHANTABILITY, FITNESS FOR A PARTICULAR PURPOSE (AND THEIR EQUIVALENTS UNDER THE LAWS OF ANY JURISDICTION), OR INFRINGEMENT OF ANY PATENT, COPYRIGHT OR OTHER INTELLECTUAL PROPERTY RIGHT.

UNLESS EXPRESSLY APPROVED IN WRITING BY TWO AUTHORIZED ST REPRESENTATIVES, ST PRODUCTS ARE NOT RECOMMENDED, AUTHORIZED OR WARRANTED FOR USE IN MILITARY, AIR CRAFT, SPACE, LIFE SAVING, OR LIFE SUSTAINING APPLICATIONS, NOR IN PRODUCTS OR SYSTEMS WHERE FAILURE OR MALFUNCTION MAY RESULT IN PERSONAL INJURY, DEATH, OR SEVERE PROPERTY OR ENVIRONMENTAL DAMAGE. ST PRODUCTS WHICH ARE NOT SPECIFIED AS "AUTOMOTIVE GRADE" MAY ONLY BE USED IN AUTOMOTIVE APPLICATIONS AT USER'S OWN RISK.

Resale of ST products with provisions different from the statements and/or technical features set forth in this document shall immediately void any warranty granted by ST for the ST product or service described herein and shall not create or extend in any manner whatsoever, any liability of ST.

ST and the ST logo are trademarks or registered trademarks of ST in various countries.

Information in this document supersedes and replaces all information previously supplied.

The ST logo is a registered trademark of STMicroelectronics. All other names are the property of their respective owners.

© 2011 STMicroelectronics - All rights reserved

STMicroelectronics group of companies

Australia - Belgium - Brazil - Canada - China - Czech Republic - Finland - France - Germany - Hong Kong - India - Israel - Italy - Japan - Malaysia - Malta - Morocco - Philippines - Singapore - Spain - Sweden - Switzerland - United Kingdom - United States of America

www.st.com