

# 2SK3556-01L,S,SJ

## FUJI POWER MOSFET Super FAP-G Series

### N-CHANNEL SILICON POWER MOSFET

#### ■ Features

- High speed switching
- Low on-resistance
- No secondary breakdown
- Low driving power
- Avalanche-proof

#### ■ Applications

- Switching regulators
- UPS (Uninterruptible Power Supply)
- DC-DC converters

#### ■ Maximum ratings and characteristic Absolute maximum ratings

● (Tc=25°C unless otherwise specified)

Item	Symbol	Ratings	Unit
Drain-source voltage	V <sub>DS</sub>	250	V
	V <sub>DSX</sub> *5	220	V
Continuous drain current	I <sub>D</sub>	±25	A
Pulsed drain current	I <sub>D(puls)</sub>	±100	A
Gate-source voltage	V <sub>GS</sub>	±30	V
Repetitive or non-repetitive	I <sub>AR</sub> *2	25	A
Maximum Avalanche Energy	E <sub>AS</sub> *1	372	mJ
Maximum Drain-Source dV/dt	dV <sub>DS</sub> /dt *4	20	kV/μs
Peak Diode Recovery dV/dt	dV/dt *3	5	kV/μs
Max. power dissipation	P <sub>D</sub>	T <sub>a</sub> =25°C	2.02
		T <sub>c</sub> =25°C	135
Operating and storage temperature range	T <sub>ch</sub>	+150	°C
	T <sub>stg</sub>	-55 to +150	°C

#### ■ Outline Drawings

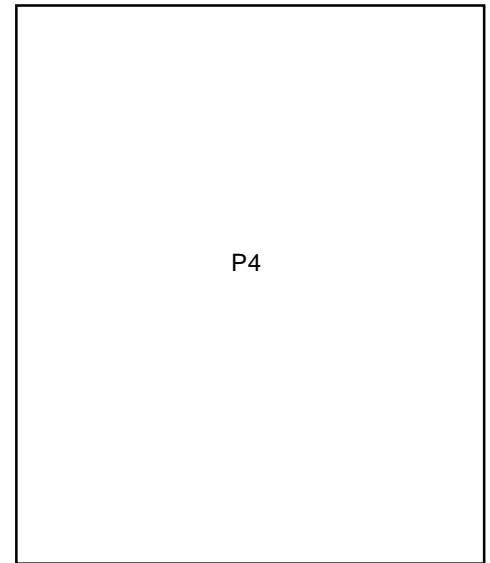

#### ■ Equivalent circuit schematic

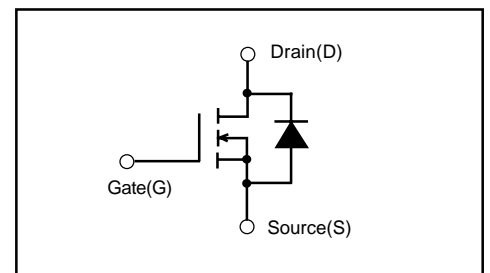

\*1 L=0.67mH, V<sub>CC</sub>=48V \*2 T<sub>ch</sub>≤150°C \*3 I<sub>F</sub>=-I<sub>D</sub>, -di/dt=50A/μs, V<sub>CC</sub>≤BV<sub>DSS</sub>, T<sub>ch</sub>≤150°C  
\*4 V<sub>DS</sub>≤250V \*5 V<sub>GS</sub>=-30V \*6 t=60sec f=60Hz

#### ● Electrical characteristics (T<sub>c</sub> =25°C unless otherwise specified)

Item	Symbol	Test Conditions	Min.	Typ.	Max.	Units
Drain-source breakdown voltage	V(BR) <sub>DSS</sub>	I <sub>D</sub> =250μA V <sub>GS</sub> =0V	250			V
Gate threshold voltage	V <sub>GS(th)</sub>	I <sub>D</sub> =250μA V <sub>DS</sub> =V <sub>GS</sub>	3.0		5.0	V
Zero gate voltage drain current	I <sub>DSS</sub>	V <sub>DS</sub> =250V V <sub>GS</sub> =0V			25	μA
		V <sub>DS</sub> =200V V <sub>GS</sub> =0V			250	
Gate-source leakage current	I <sub>GSS</sub>	V <sub>GS</sub> =±30V V <sub>DS</sub> =0V		10	100	nA
Drain-source on-state resistance	R <sub>DS(on)</sub>	I <sub>D</sub> =12.5A V <sub>GS</sub> =10V		75	100	mΩ
Forward transconductance	g <sub>fs</sub>	I <sub>D</sub> =12.5A V <sub>DS</sub> =25V	8	16		S
Input capacitance	C <sub>iss</sub>	V <sub>DS</sub> =75V		2000	3000	pF
Output capacitance	C <sub>oss</sub>	V <sub>GS</sub> =0V		220	330	
Reverse transfer capacitance	C <sub>rss</sub>	f=1MHz		15	30	
Turn-on time t <sub>on</sub>	td(on)	V <sub>CC</sub> =72V I <sub>D</sub> =12.5A		20	30	ns
	t <sub>r</sub>	V <sub>GS</sub> =10V		30	45	
Turn-off time t <sub>off</sub>	td(off)	R <sub>GS</sub> =10 Ω		60	90	
	t <sub>f</sub>			20	30	
Total Gate Charge	Q <sub>G</sub>	V <sub>CC</sub> =72V		44	66	nC
Gate-Source Charge	Q <sub>GS</sub>	I <sub>D</sub> =12A		14	21	
Gate-Drain Charge	Q <sub>GD</sub>	V <sub>GS</sub> =10V		16	24	
Avalanche capability	I <sub>AV</sub>	L=100μH T <sub>ch</sub> =25°C	25			A
Diode forward on-voltage	V <sub>SD</sub>	I <sub>F</sub> =25A V <sub>GS</sub> =0V T <sub>ch</sub> =25°C		1.10	1.65	V
Reverse recovery time	t <sub>rr</sub>	I <sub>F</sub> =25A V <sub>GS</sub> =0V		0.45		μs
Reverse recovery charge	Q <sub>rr</sub>	-di/dt=100A/μs T <sub>ch</sub> =25°C		1.5		μC

#### ● Thermal characteristics

Item	Symbol	Test Conditions	Min.	Typ.	Max.	Units
Thermal resistance	R <sub>th(ch-c)</sub>	channel to case			0.926	°C/W
	R <sub>th(ch-a)</sub>	channel to ambient			62.0	°C/W

■ Characteristics

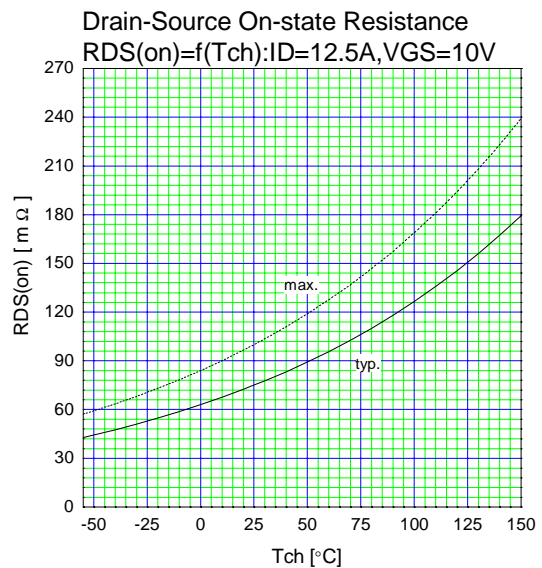
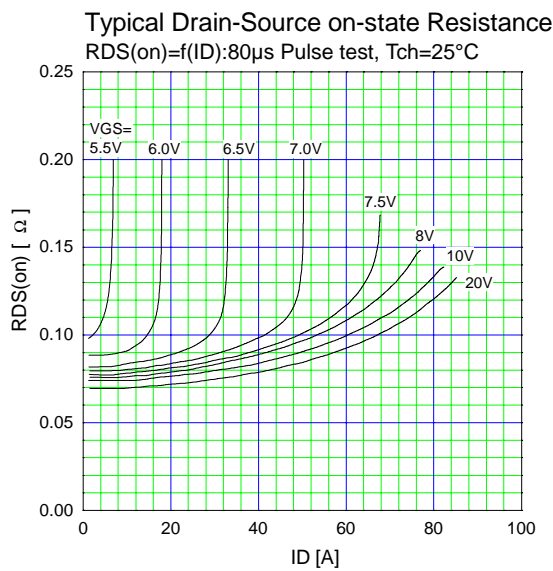
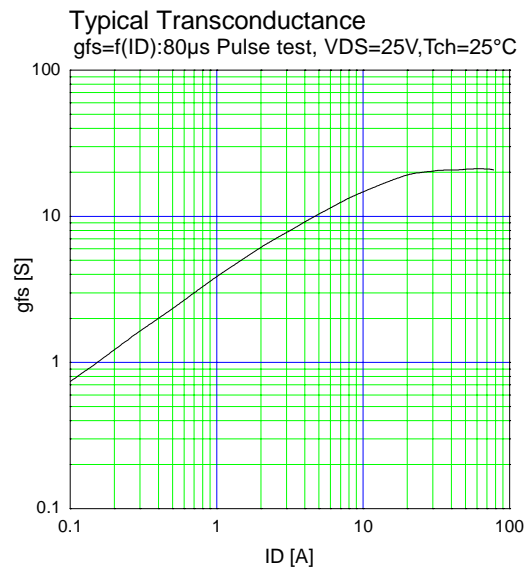
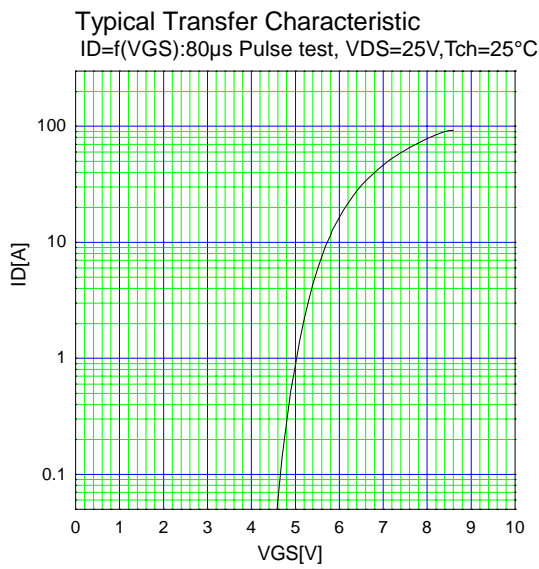
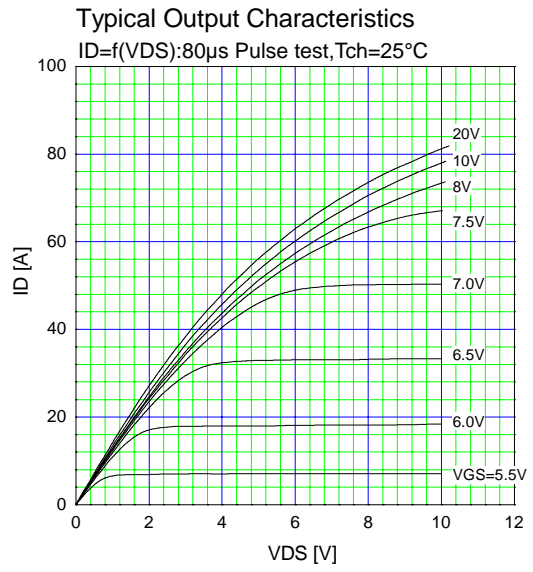
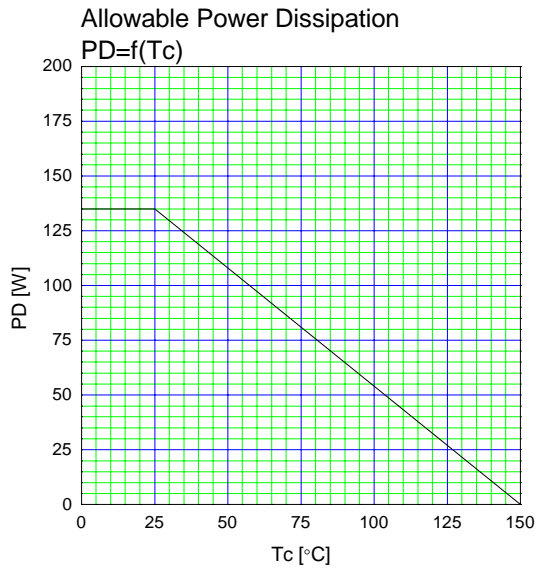

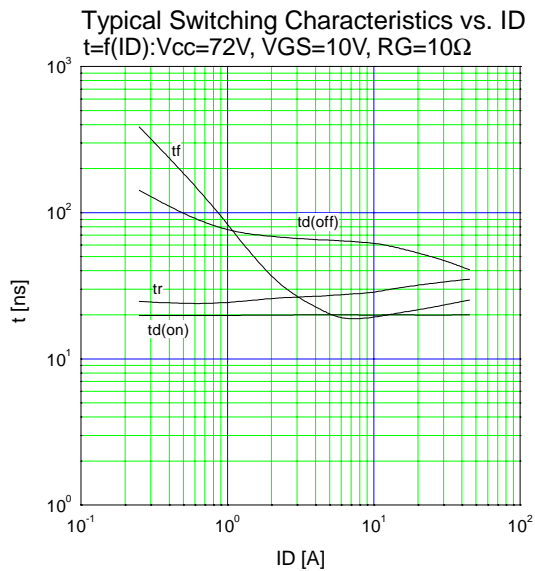
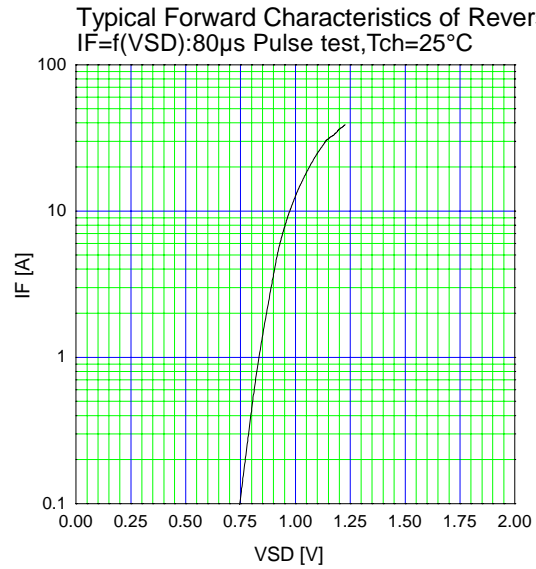
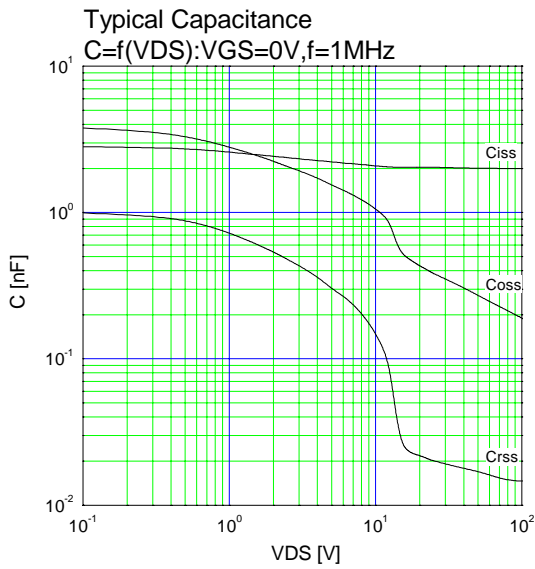
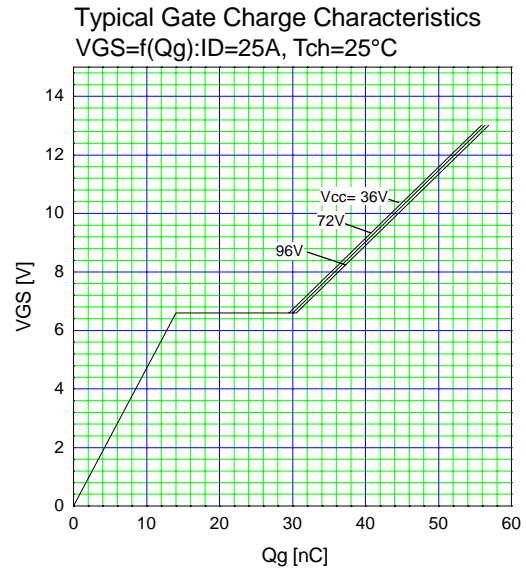
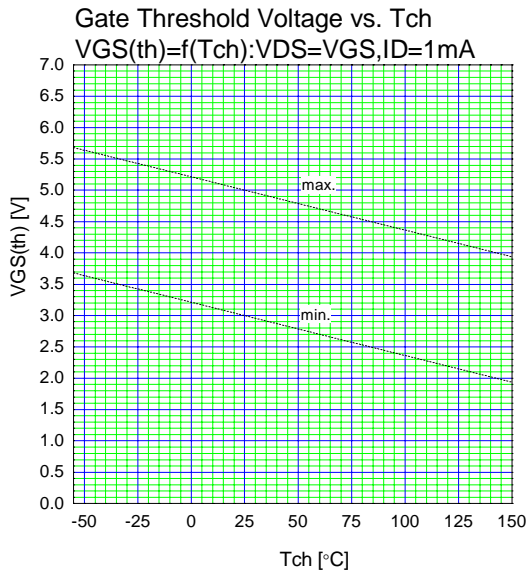

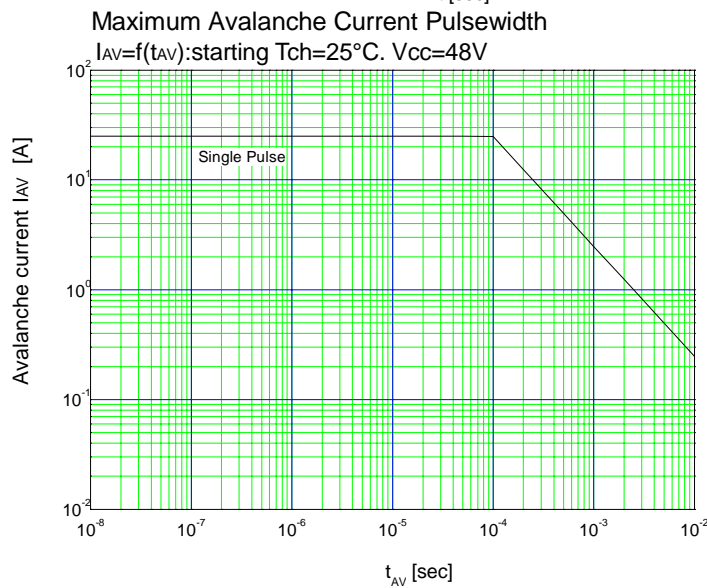
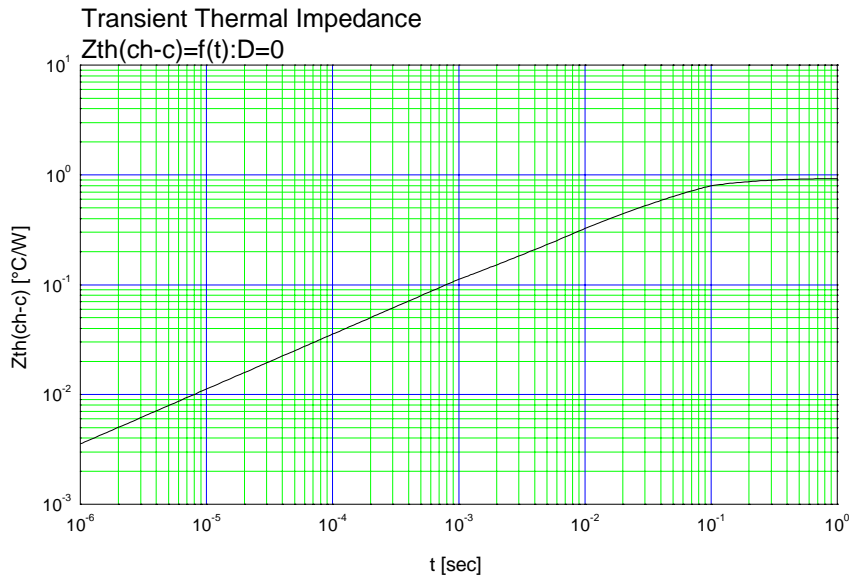

■ Outline Drawings (mm)

Type(L)

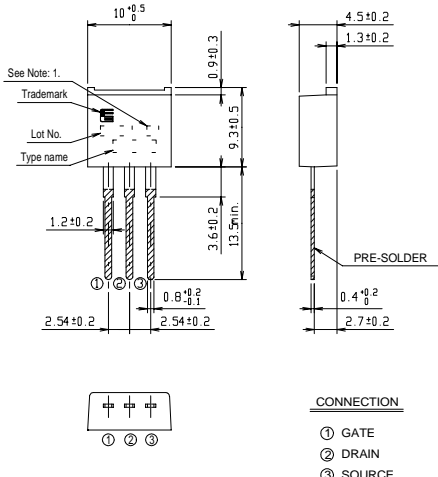

Type(S)

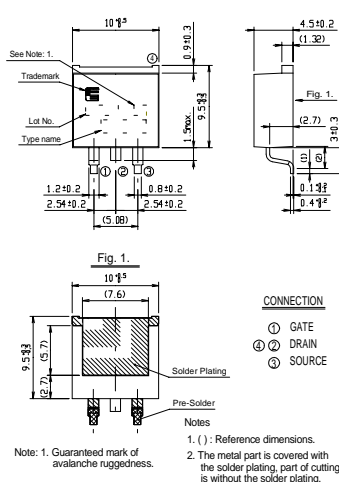

Type(SJ)

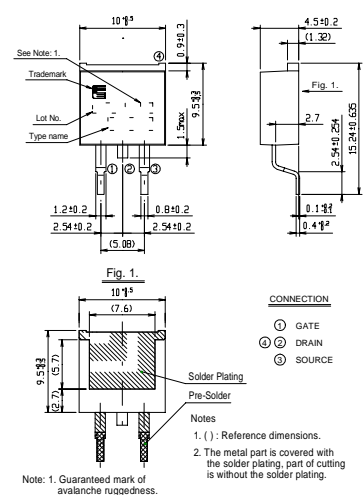

Note: 1. Guaranteed mark of avalanche ruggedness.