

Automotive-Grade, Galvanically Isolated Current Sensor IC with Common-Mode Field Rejection and Overcurrent Detection in Small Footprint Low-Profile Packages

FEATURES AND BENEFITS

- AEC-Q100 automotive qualified
- Differential Hall sensing rejects common-mode fields
- Integrated shield virtually eliminates capacitive coupling from current conductor to die, greatly suppressing output noise due to high dv/dt transients
- Industry-leading noise performance with greatly improved bandwidth through proprietary amplifier and filter design techniques
- High bandwidth 120 kHz analog output for faster response times in control applications
- Patented integrated digital temperature compensation circuitry allows for near closed-loop accuracy over temperature in an open loop sensor
- Single supply operation with nonratiometric output at 3.3 and 5 V options
- Overcurrent $\overline{\text{FAULT}}$ available between 50% and 200% I_p with 1.5 μs (typ) response time
- Non-ratiometric output provides immunity to noisy supplies
- Small footprint QFN-12 with wettable flank and SOIC-8 suitable for space-constrained automotive applications
- 0.6 m Ω (QFN-12) or 1.2 m Ω (SOIC-8) primary conductor resistance for low power loss and high inrush current withstand capability
- UL certified package (SOIC-8 only) for voltage isolation

PACKAGES:

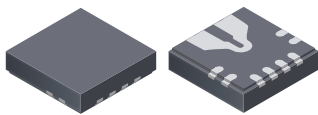

12-contact QFN with wettable flank
3 mm × 3 mm × 0.75 mm
(EXB package) *Not to scale*

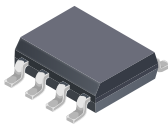

8-pin SOIC
with internally fused path
(LCB package)

DESCRIPTION

The Allegro™ ACS71240 current sensor IC is an economical and precise solution for AC or DC current sensing in industrial, automotive, commercial, and communications applications.

The device consists of a precise, low-offset linear Hall sensor circuit with a copper conduction path located near the surface of the die. Applied current flowing through this copper path generates a magnetic field which is sensed by the integrated Hall IC and converted into a proportional voltage. The resistance of the integrated conductor is far less than typical sense resistors, which reduces power loss and improves efficiency.

Rejection of external common-mode magnetic fields is achieved through differential sensing, enabling high accuracy in magnetically noisy environments. A precise voltage proportional to the measured current is generated by the low-offset, chopper-stabilized Hall front end.

Zero ampere output voltage and device sensitivity are programmed at the Allegro factory to provide a high accuracy solution across the full automotive temperature range.

The ACS71240 includes an integrated fault comparator for simplified overcurrent detection. The ultrafast response time provides the system with ample time to detect and protect against short-circuit events.

The ACS71240 is provided in small, low-profile surface-mount package options: QFN-12 with wettable flank and SOIC-8. Internally, the flip-chip device is considered Pb-free. However, the solder bump connections contained within the package are available in Pb-free or high-temperature Pb-based options. Part numbers followed by -S are manufactured with tin-silver-based solder bumps, making these parts Pb-free without the use of RoHS exemptions. Part numbers without the -S are manufactured with Pb-based solder bumps using allowed RoHS exemptions.

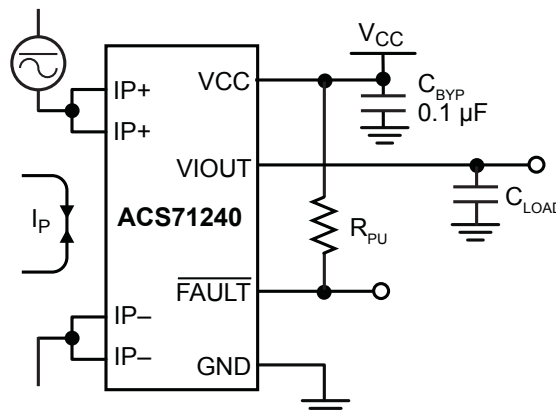

Figure 1: Typical Application

ACS71240

Automotive-Grade, Galvanically Isolated Current Sensor IC with Common-Mode Field Rejection and Overcurrent Detection in Small Footprint Low-Profile Packages

SELECTION GUIDE

Part Number ^[1]	Supply Voltage, V _{CC} (V)	Optimized Accuracy Range, I _{PR} (A)	Sensitivity (Typ) (mV/A)	Fault Trip Level (A)	Operating Ambient Temperature Range, T _A (°C)	Package	Packing ^[2]
ACS71240KEXBLT-010B3	3.3	±10	132	±10	-40 to 125	12-contact QFN with wettable flank (EXB)	1500 pieces per 7-inch reel
ACS71240KEXBLT-010B3-115	3.3	±10	132	±11.5			
ACS71240KEXBLT-030B3	3.3	±30	44	±30			
ACS71240KEXBLT-030B3-167L	3.3	±30	44	±50, latched ^[3]			
ACS71240KEXBLT-050B3	3.3	±50	26.4	±50			
ACS71240KEXBLT-050B3-120	3.3	±50	26.4	±60			
ACS71240KEXBLT-010B5	5	±10	200	±10			
ACS71240KEXBLT-020B5	5	±20	100	±20			
ACS71240KEXBLT-020B5-150L	5	±20	100	±30, latched ^[3]			
ACS71240KEXBLT-030B5	5	±30	66	±30			
ACS71240KEXBLT-045B5	5	±45	44.4	±45			
ACS71240KEXBLT-050B5	5	±50	40	±50			
ACS71240KEXBLT-050U5	5	50	80	50			
ACS71240LLCBTR-010B3	3.3	±10	132	±10	-40 to 150	8-pin SOIC with internally fused path (LCB)	3000 pieces per 13-inch reel
ACS71240LLCBTR-025B3	3.3	±25	55	±25			
ACS71240LLCBTR-030B3	3.3	±30	44	±30			
ACS71240LLCBTR-050B3	3.3	±50	26.4	±50			
ACS71240LLCBTR-020U5	5	20	200	20			
ACS71240LLCBTR-045B5	5	±45	44.4	±45			
ACS71240LLCBTR-050B5	5	±50	40	±50			
ACS71240LLCBTR-050U5	5	50	80	50			

^[1] Devices without -S have Pb-contained construction with Pb-based solder bumps. Operating performance of -S devices are identical to devices without -S. Devices without -S are RoHS compliant using allowed exemptions provided in Annex III and IV of Directive 2011/65/EU [Exemptions 7(a), 15, 15(a), as applicable].

^[2] Contact Allegro for additional packing options.

^[3] See application section for more information regarding latched fault behavior.

Continued on next page...

ACS71240

Automotive-Grade, Galvanically Isolated Current Sensor IC with Common-Mode Field Rejection and Overcurrent Detection in Small Footprint Low-Profile Packages

SELECTION GUIDE

Part Number [1]	Supply Voltage, V_{CC} (V)	Optimized Accuracy Range, I_{PR} (A)	Sensitivity (Typ) (mV/A)	Fault Trip Level (A)	Operating Ambient Temperature Range, T_A (°C)	Package	Packing [2]
ACS71240KEXBLT-010B3-S	3.3	±10	132	±10	-40 to 125	12-contact QFN with wettable flank (EXB)	1500 pieces per 7-inch reel
ACS71240KEXBLT-010B3-115-S	3.3	±10	132	±11.5			
ACS71240KEXBLT-020B3-S	3.3	±20	66	±20			
ACS71240KEXBLT-030B3-S	3.3	±30	44	±30			
ACS71240KEXBLT-030B3-167L-S	3.3	±30	44	±50, latched [3]			
ACS71240KEXBLT-050B3-120-S	3.3	±50	26.4	±60			
ACS71240KEXBLT-010B5-S	5	±10	200	±10			
ACS71240KEXBLT-020B5-S	5	±20	100	±20			
ACS71240KEXBLT-030B5-S	5	±30	66	±30			
ACS71240LLCBTR-010B3-S	3.3	±10	132	±10	-40 to 150	8-pin SOIC with internally fused path (LCB)	3000 pieces per 13-inch reel
ACS71240LLCBTR-030B3-S	3.3	±30	44	±30			
ACS71240LLCBTR-050B3-S	3.3	±50	26.4	±50			
ACS71240LLCBTR-045B5-S	5	±45	44.4	±45			
ACS71240LLCBTR-050U5-S	5	50	80	50			

[1] -S denotes the lead-free construction with tin-silver-based solder bumps. Advanced information. Pb-free variants are not yet released.

[2] Contact Allegro for additional packing options.

[3] See application section for more information regarding latched fault behavior.

Naming Specification

ACS71240KEXBTR-010B3-115-S

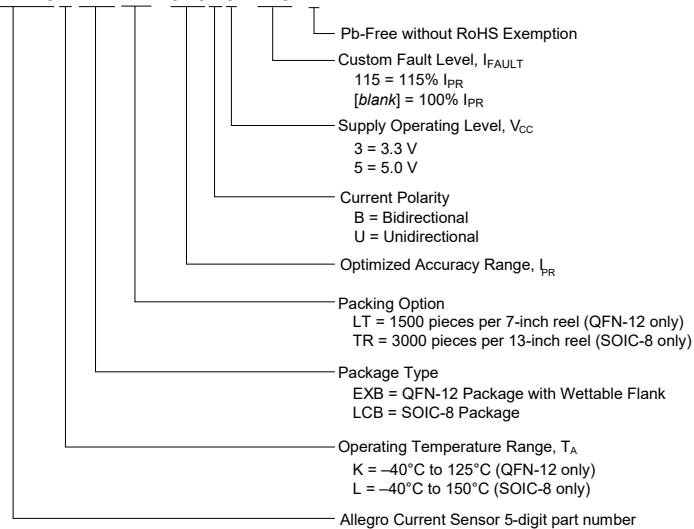

ACS71240

Automotive-Grade, Galvanically Isolated Current Sensor IC with Common-Mode Field Rejection and Overcurrent Detection in Small Footprint Low-Profile Packages

ABSOLUTE MAXIMUM RATINGS

Characteristic	Symbol	Notes	Rating	Units	
Supply Voltage	V_{CC}		6	V	
Reverse Supply Voltage	$V_{CC(R)}$		-0.5	V	
Output Voltage	V_{IOUT}		$V_{CC} + 0.7$	V	
Reverse Output Voltage	$V_{IOUT(R)}$		-0.5	V	
FAULT Voltage	V_{FAULT}		25	V	
Reverse FAULT Voltage	$V_{FAULT(R)}$		-0.5	V	
Maximum Continuous Current	I_{CMAX}	$T_A = 25^\circ\text{C}$	QFN-12 package	60	A
			SOIC-8 package	55	A
Operating Ambient Temperature Range	T_A	Range K (QFN-12 package)		-40 to 125	$^\circ\text{C}$
		Range L (SOIC-8 package)		-40 to 150	$^\circ\text{C}$
Maximum Junction Temperature	$T_{J(MAX)}$		165	$^\circ\text{C}$	
Storage Temperature Range	T_{stg}		-65 to 170	$^\circ\text{C}$	

ESD RATINGS

Characteristic	Symbol	Test Conditions	Value	Unit	
Human Body Model	V_{HBM}	Per JEDEC JS-001	SOIC-8 package	± 6.5	kV
			QFN-12 package	± 4.0	kV
Charged Device Model	V_{CDM}	Per JEDEC JS-002	± 1	kV	

ISOLATION CHARACTERISTICS (for SOIC-8 package only)

Characteristic	Symbol	Notes	Value	Units
Dielectric Surge Strength Test Voltage	V_{SURGE}	Tested ± 5 pulses at 2/minute in compliance to IEC 61000-4-5 1.2 μs (rise) / 50 μs (width).	6000	V
Dielectric Strength Test Voltage	V_{ISO}	Agency type-tested for 60 seconds per UL 60950-1 (edition 2); production-tested at V_{ISO} for 1 second, in accordance with UL 60950-1 (edition 2)	2400	V_{RMS}
Working Voltage for Basic Isolation	V_{WVBI}	Maximum approved working voltage for basic (single) isolation according to UL 60950-1 (edition 2)	420	V_{PK} or V_{DC}
			297	V_{RMS}
Clearance	D_{cl}	Minimum distance through air from IP leads to signal leads	4.2	mm
Creepage	D_{cr}	Minimum distance along package body from IP leads to signal leads	4.2	mm
Comparative Tracking Index	CTI	Material Group II	400 to 599	V

ISOLATION CHARACTERISTICS (for QFN-12 package only)

Characteristic	Symbol	Notes	Value	Units
Working Voltage for Basic Isolation ^[1]	V_{WVBI}	Voltage applied between pins 1-4 and 5-12	100	V_{PK} or V_{DC}

^[1] Based on characterization. No agency testing was conducted.

PINOUT DIAGRAMS AND TERMINAL LIST TABLES

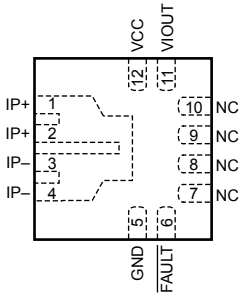

**Package EX, 12-Pin QFN
Pinout Diagram**

Terminal List Table (QFN-12)

Number	Name	Description
1, 2	IP+	Positive terminals for current being sensed; fused internally
3, 4	IP-	Negative terminals for current being sensed; fused internally
5	GND	Signal ground terminal
6	FAULT	Overcurrent fault; active low
7, 8, 9, 10	NC	No connection; connect to ground for optimal ESD performance
11	VIOUT	Analog output signal
12	VCC	Device power supply terminal

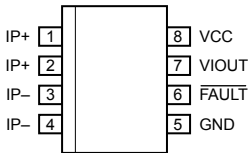

**Package LC, 8-Pin SOIC
Pinout Diagram**

Terminal List Table (SOIC-8)

Number	Name	Description
1, 2	IP+	Positive terminals for current being sensed; fused internally
3, 4	IP-	Negative terminals for current being sensed; fused internally
5	GND	Signal ground terminal
6	FAULT	Overcurrent fault; active low
7	VIOUT	Analog output signal
8	VCC	Device power supply terminal

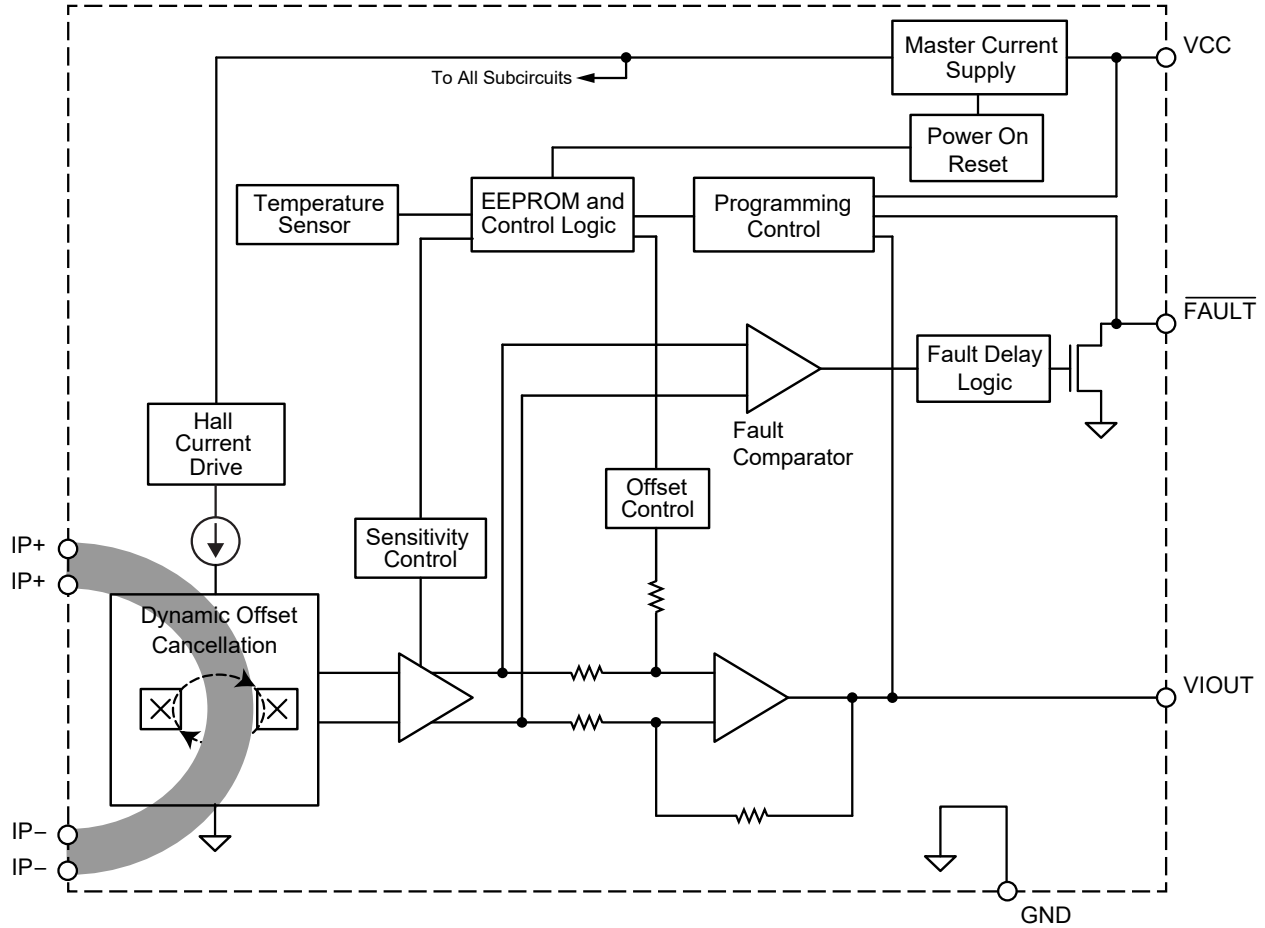

Functional Block Diagram

COMMON ELECTRICAL CHARACTERISTICS: Valid through the full range of T_A and $V_{CC} = 5\text{ V}$ or 3.3 V , unless otherwise specified

Characteristic	Symbol	Test Conditions	Min.	Typ. [1]	Max.	Unit	
ELECTRICAL CHARACTERISTICS							
Supply Voltage	V_{CC}	5 V variant	4.5	5.0	5.5	V	
		3.3 V variant	3.0	3.3	3.6	V	
Supply Current	I_{CC}	5 V variant, no load on V_{IOUT}	–	10	12	mA	
		3.3 V variant, no load on V_{IOUT}	–	7.5	12	mA	
Output Capacitive Load	C_L	V_{IOUT} to GND	–	–	4.7	nF	
Output Resistive Load	R_L	V_{IOUT} to GND	10	–	–	k Ω	
Primary Conductor Resistance	R_{IP}	$T_A = 25^\circ\text{C}$	QFN-12 package	–	0.6	–	m Ω
			SOIC-8 package	–	1.2	–	m Ω
Primary Conductor Inductance	L_{IP}	$T_A = 25^\circ\text{C}$	QFN-12 package	–	1.5	–	nH
			SOIC-8 package	–	2	–	nH
Primary Hall Coupling Factor	G_1	$T_A = 25^\circ\text{C}$	QFN-12 package	–	10	–	G/A
			SOIC-8 package	–	11	–	G/A
Secondary Hall Coupling Factor	G_2	$T_A = 25^\circ\text{C}$	QFN-12 package	–	–2	–	G/A
			SOIC-8 package	–	–2.8	–	G/A
Hall Plate Sensitivity Matching	$Sens_{match}$	$T_A = 25^\circ\text{C}$	–	± 1	–	%	
Common Mode Field Rejection	CMFR	Offset due to DC common field	QFN-12 package	–	1.2	–	mA/G
			SOIC-8 package	–	0.6	–	mA/G
Rise Time [2]	t_r	$T_A = 25^\circ\text{C}$, $C_L = 1\text{ nF}$	–	3	4	μs	
Propagation Delay [2]	t_{pd}	$T_A = 25^\circ\text{C}$, $C_L = 1\text{ nF}$	–	1.6	2.2	μs	
Response Time [2]	$t_{RESPONSE}$	$T_A = 25^\circ\text{C}$, $C_L = 1\text{ nF}$	–	4	4.9	μs	
Output Slew Rate	SR	$T_A = 25^\circ\text{C}$, $C_L = 1\text{ nF}$	–	0.53	–	V/ μs	
Bandwidth	BW	Small signal –3 dB; $C_L = 1\text{ nF}$	–	120	–	kHz	
Noise Density	I_{ND}	$V_{CC} = 5.0\text{ V}$, input referred, $T_A = 25^\circ\text{C}$, $C_L = 1\text{ nF}$	–	100	–	$\mu\text{A}_{RMS}/\sqrt{\text{Hz}}$	
		$V_{CC} = 3.3\text{ V}$, input referred, $T_A = 25^\circ\text{C}$, $C_L = 1\text{ nF}$	–	150	–	$\mu\text{A}_{RMS}/\sqrt{\text{Hz}}$	
Noise	I_N	$V_{CC} = 5.0\text{ V}$, input referred, $T_A = 25^\circ\text{C}$, $C_L = 1\text{ nF}$	–	52	–	mA_{RMS}	
		$V_{CC} = 3.3\text{ V}$, input referred, $T_A = 25^\circ\text{C}$, $C_L = 1\text{ nF}$	–	78	–	mA_{RMS}	
Nonlinearity	E_{LIN}	Up to $I_p = 10\text{ A}$	QFN-12 package	–1	–	1	%
		Through full range of I_p	SOIC-8 package	–1	–	1	%
Power Supply Rejection Ratio	PSRR	$V_{CC} = V_{CC} \pm 10\%$, $T_A = 25^\circ\text{C}$, DC to 1 kHz	–	40	–	dB	
		$V_{CC} = V_{CC} \pm 10\%$, $T_A = 25^\circ\text{C}$, 1 kHz to 20 kHz	–	30	–	dB	
		$V_{CC} = V_{CC} \pm 10\%$, $T_A = 25^\circ\text{C}$, 20 kHz to 60 kHz	–	20	–	dB	
Output Saturation Voltage [3]	V_{SAT_H}	$R_L = 10\text{ k}\Omega$	$V_{CC} - 0.3$	–	–	V	
	V_{SAT_L}	$R_L = 10\text{ k}\Omega$	–	–	0.3	V	
Power-On Time	t_{PO}	$T_A = 25^\circ\text{C}$	–	80	–	μs	
Shorted Output-to-Ground Current	$I_{SC(GND)}$	$T_A = 25^\circ\text{C}$	–	30	–	mA	
Shorted Output-to- V_{CC} Current	$I_{SC(VCC)}$	$T_A = 25^\circ\text{C}$	–	1.8	–	mA	

Continued on next page...

COMMON ELECTRICAL CHARACTERISTICS (continued): Valid through the full range of T_A and V_{CC} , unless otherwise specified

Characteristic	Symbol	Test Conditions	Min.	Typ. [1]	Max.	Unit
FAULT CHARACTERISTICS						
$\overline{\text{FAULT}}$ Current Hysteresis [4]	$I_{F(\text{HYS})}$	Percent of $I_{PR(\text{MAX})}$	3	12	–	%
$\overline{\text{FAULT}}$ Output Pullup Resistor	R_{PU}		10	–	500	k Ω
$\overline{\text{FAULT}}$ Output Voltage	V_{OL}	$R_{PU} = 10 \text{ k}\Omega$, during fault condition	–	–	0.3	V
$\overline{\text{FAULT}}$ Response Time [5]	$t_{\overline{\text{FAULT}}}$	Time from $ I_P $ rising above $ I_{\overline{\text{FAULT}}} $ until $V_{\overline{\text{FAULT}}} < V_{OL(\text{MAX})} - 100 \text{ pF}$ from $\overline{\text{FAULT}}$ to GND. Input current step 20% above $I_{\overline{\text{FAULT}}}$ with rise time $\leq 1 \mu\text{s}$.	–	1.5	2.5	μs
$\overline{\text{FAULT}}$ Error	E_F	$I_{\overline{\text{FAULT}}}$, $T_A = 25^\circ\text{C}$	–10	± 3.5	10	%
		$T_A = -40^\circ\text{C}$ or $T_{A(\text{MAX})}$	–10	± 5	10	%

[1] Typical values with \pm are 3 sigma values.

[2] Guaranteed by design. Limit calculated using 6 sigma. Not tested in production.

[3] The sensor will continue to respond to current beyond the range of I_P until the high or low saturation voltage; however, the nonlinearity in this region will be worse than through the rest of the measurement range. The extended current sensing range, $I_{P(\text{EXT})}$, can be calculated using the following equation:

$$I_{P(\text{EXT})} [\text{A}] = (V_{\text{SAT_H}} [\text{V}] - V_{\text{IOUT(Q)}} [\text{V}]) \times 1000 / \text{Sens} [\text{mV/A}]$$

[4] Tested on all devices using trim settings set to ACS71240-10B.

[5] Not tested in production.

ACS71240

Automotive-Grade, Galvanically Isolated Current Sensor IC with Common-Mode Field Rejection and Overcurrent Detection in Small Footprint Low-Profile Packages

ACS71240KEXBLT-010B3 PERFORMANCE CHARACTERISTICS: Over full range of T_A , $V_{CC} = 3.3\text{ V}$, unless otherwise specified

Characteristic	Symbol	Test Conditions	Min.	Typ. [1]	Max.	Unit
NOMINAL PERFORMANCE						
Optimized Sensing Range	I_{PR}		-10	-	10	A
Sensitivity	Sens	$I_{PR(min)} < I_P < I_{PR(max)}$	-	132	-	mV/A
Zero-Current Output Voltage	$V_{IOUT(Q)}$	Bidirectional, $I_P = 0\text{ A}$	-	1.65	-	V
ACCURACY PERFORMANCE						
Total Output Error [2]	E_{TOT}	$I_P = 10\text{ A}$, $T_A = 25^\circ\text{C}$ to 125°C	-2.5	± 1.2	2.5	%
		$I_P = 10\text{ A}$, $T_A = -40^\circ\text{C}$ to 25°C	-6	± 2.5	6	%
TOTAL OUTPUT ERROR COMPONENTS [3] $E_{TOT} = E_{SENS} + 100 \times V_{OE} / (\text{Sens} \times I_P)$						
Sensitivity Error	E_{SENS}	$I_P = 10\text{ A}$, $T_A = 25^\circ\text{C}$ to 125°C	-2	± 1.0	2	%
		$I_P = 10\text{ A}$, $T_A = -40^\circ\text{C}$ to 25°C	-5.5	± 2.2	5.5	%
Voltage Offset Error	V_{OE}	$I_P = 0\text{ A}$, $T_A = 25^\circ\text{C}$ to 125°C	-15	± 6.3	15	mV
		$I_P = 0\text{ A}$, $T_A = -40^\circ\text{C}$ to 25°C	-30	± 8.6	30	mV
ACCURACY PERFORMANCE INCLUDING LIFETIME DRIFT [4]						
Total Output Error Including Lifetime Drift [5]	E_{TOT_drift}	$I_P = 10\text{ A}$, $T_A = 25^\circ\text{C}$ to 125°C	-5.7	± 1.8	5.7	%
		$I_P = 10\text{ A}$, $T_A = -40^\circ\text{C}$ to 25°C	-6	± 1.5	6	%
Sensitivity Error Including Lifetime Drift [6]	E_{SENS_drift}	$I_P = 10\text{ A}$, $T_A = 25^\circ\text{C}$ to 125°C	-5.1	± 1.2	5.1	%
		$I_P = 10\text{ A}$, $T_A = -40^\circ\text{C}$ to 25°C	-5.6	± 1.2	5.6	%
Offset Voltage Error Including Lifetime Drift [7]	V_{OE_drift}	$I_P = 0\text{ A}$, $T_A = 25^\circ\text{C}$ to 125°C	-28	± 4.5	28	mV
		$I_P = 0\text{ A}$, $T_A = -40^\circ\text{C}$ to 25°C	-30	± 4.3	30	mV
FAULT CHARACTERISTICS						
FAULT Operating Point	I_{FAULT}		-	$\pm 1 \times I_{PR}$	-	A

[1] Typical values are mean ± 3 sigma values, except for lifetime drift, which are the average value including drift (from the worst case stress) after AEC-Q100 qualification.

[2] Percentage of I_P .

[3] A single device will not have both the maximum/minimum sensitivity error and maximum/minimum offset voltage, as that would violate the maximum/minimum total output error specification.

[4] Lifetime drift characteristics are based on AEC-Q100 qualification results.

[5] All devices stayed within min/max limits throughout AEC-Q100 qualification. The worst drift observed was 6.1%.

[6] All devices stayed within min/max limits throughout AEC-Q100 qualification. The worst drift observed was 4%.

[7] All devices stayed within min/max limits throughout AEC-Q100 qualification. The worst drift observed was 22 mV.

ACS71240KEXBLT-010B3-115 Variant

Characteristic	Symbol	Test Conditions	Min.	Typ. [1]	Max.	Unit
NON-STANDARD FAULT CHARACTERISTICS						
FAULT Operating Point	I_{FAULT}		-	$\pm 1.15 \times I_{PR}$	-	A

[1] Typical values are mean ± 3 sigma values

ACS71240

Automotive-Grade, Galvanically Isolated Current Sensor IC with Common-Mode Field Rejection and Overcurrent Detection in Small Footprint Low-Profile Packages

ACS71240KEXBLT-030B3 PERFORMANCE CHARACTERISTICS: Over full range of T_A , $V_{CC} = 3.3$ V, unless otherwise specified

Characteristic	Symbol	Test Conditions	Min.	Typ. [1]	Max.	Unit
NOMINAL PERFORMANCE						
Optimized Sensing Range	I_{PR}		-30	-	30	A
Sensitivity	Sens	$I_{PR(min)} < I_P < I_{PR(max)}$	-	44	-	mV/A
Zero-Current Output Voltage	$V_{IOUT(Q)}$	Bidirectional, $I_P = 0$ A	-	1.65	-	V
ACCURACY PERFORMANCE						
Total Output Error [2]	E_{TOT}	$I_P = 10$ A, $T_A = 25^\circ\text{C}$ to 125°C	-2.5	± 1.2	2.5	%
		$I_P = 10$ A, $T_A = -40^\circ\text{C}$ to 25°C	-6	± 2.5	6	%
TOTAL OUTPUT ERROR COMPONENTS [3] $E_{TOT} = E_{SENS} + 100 \times V_{OE} / (\text{Sens} \times I_P)$						
Sensitivity Error	E_{SENS}	$I_P = 10$ A, $T_A = 25^\circ\text{C}$ to 125°C	-2	± 1.5	2	%
		$I_P = 10$ A, $T_A = -40^\circ\text{C}$ to 25°C	-5.5	± 2.4	5.5	%
Voltage Offset Error	V_{OE}	$I_P = 0$ A, $T_A = 25^\circ\text{C}$ to 125°C	-15	± 3.8	15	mV
		$I_P = 0$ A, $T_A = -40^\circ\text{C}$ to 25°C	-30	± 7.1	30	mV
ACCURACY PERFORMANCE INCLUDING LIFETIME DRIFT [4]						
Total Output Error Including Lifetime Drift [5]	E_{TOT_drift}	$I_P = 10$ A, $T_A = 25^\circ\text{C}$ to 125°C	-5.7	± 1.8	5.7	%
		$I_P = 10$ A, $T_A = -40^\circ\text{C}$ to 25°C	-6	± 1.5	6	%
Sensitivity Error Including Lifetime Drift [6]	E_{SENS_drift}	$I_P = 10$ A, $T_A = 25^\circ\text{C}$ to 125°C	-5.1	± 1.2	5.1	%
		$I_P = 10$ A, $T_A = -40^\circ\text{C}$ to 25°C	-5.6	± 1.2	5.6	%
Offset Voltage Error Including Lifetime Drift [7]	V_{OE_drift}	$I_P = 0$ A, $T_A = 25^\circ\text{C}$ to 125°C	-28	± 4.5	28	mV
		$I_P = 0$ A, $T_A = -40^\circ\text{C}$ to 25°C	-30	± 4.3	30	mV
FAULT CHARACTERISTICS						
FAULT Operating Point	I_{FAULT}		-	$\pm 1 \times I_{PR}$	-	A

[1] Typical values are mean ± 3 sigma values, except for lifetime drift, which are the average value including drift (from the worst case stress) after AEC-Q100 qualification.

[2] Percentage of I_P .

[3] A single device will not have both the maximum/minimum sensitivity error and maximum/minimum offset voltage, as that would violate the maximum/minimum total output error specification.

[4] Lifetime drift characteristics are based on AEC-Q100 qualification results.

[5] All devices stayed within min/max limits throughout AEC-Q100 qualification. The worst drift observed was 6.1%.

[6] All devices stayed within min/max limits throughout AEC-Q100 qualification. The worst drift observed was 4%.

[7] All devices stayed within min/max limits throughout AEC-Q100 qualification. The worst drift observed was 22 mV.

ACS71240KEXBLT-030B3-167L Variant

Characteristic	Symbol	Test Conditions	Min.	Typ. [1]	Max.	Unit
NON-STANDARD FAULT CHARACTERISTICS						
FAULT Operating Point	I_{FAULT}		-	$\pm 1.67 \times I_{PR}$	-	A
Fault Latch	-		Enabled			-

[1] Typical values are mean ± 3 sigma values

ACS71240

Automotive-Grade, Galvanically Isolated Current Sensor IC with Common-Mode Field Rejection and Overcurrent Detection in Small Footprint Low-Profile Packages

ACS71240KEXBLT-050B3 PERFORMANCE CHARACTERISTICS: Over full range of T_A , $V_{CC} = 3.3$ V, unless otherwise specified

Characteristic	Symbol	Test Conditions	Min.	Typ. [1]	Max.	Unit
NOMINAL PERFORMANCE						
Optimized Sensing Range	I_{PR}		-50	-	50	A
Sensitivity	Sens	$I_{PR(min)} < I_P < I_{PR(max)}$	-	26.4	-	mV/A
Zero-Current Output Voltage	$V_{IOUT(Q)}$	Bidirectional, $I_P = 0$ A	-	1.65	-	V
ACCURACY PERFORMANCE						
Total Output Error [2]	E_{TOT}	$I_P = 10$ A, $T_A = 25^\circ\text{C}$ to 125°C	-2.5	± 1.5	2.5	%
		$I_P = 10$ A, $T_A = -40^\circ\text{C}$ to 25°C	-6	± 2.6	6	%
TOTAL OUTPUT ERROR COMPONENTS [3] $E_{TOT} = E_{SENS} + 100 \times V_{OE} / (\text{Sens} \times I_P)$						
Sensitivity Error	E_{SENS}	$I_P = 10$ A, $T_A = 25^\circ\text{C}$ to 125°C	-2	± 1.1	2	%
		$I_P = 10$ A, $T_A = -40^\circ\text{C}$ to 25°C	-5.5	± 1.7	5.5	%
Voltage Offset Error	V_{OE}	$I_P = 0$ A, $T_A = 25^\circ\text{C}$ to 125°C	-15	± 3	15	mV
		$I_P = 0$ A, $T_A = -40^\circ\text{C}$ to 25°C	-30	± 10	30	mV
ACCURACY PERFORMANCE INCLUDING LIFETIME DRIFT [4]						
Total Output Error Including Lifetime Drift [5]	E_{TOT_drift}	$I_P = 10$ A, $T_A = 25^\circ\text{C}$ to 125°C	-5.7	± 1.8	5.7	%
		$I_P = 10$ A, $T_A = -40^\circ\text{C}$ to 25°C	-6	± 1.5	6	%
Sensitivity Error Including Lifetime Drift [6]	E_{SENS_drift}	$I_P = 10$ A, $T_A = 25^\circ\text{C}$ to 125°C	-5.1	± 1.2	5.1	%
		$I_P = 10$ A, $T_A = -40^\circ\text{C}$ to 25°C	-5.6	± 1.2	5.6	%
Offset Voltage Error Including Lifetime Drift [7]	V_{OE_drift}	$I_P = 0$ A, $T_A = 25^\circ\text{C}$ to 125°C	-28	± 4.5	28	mV
		$I_P = 0$ A, $T_A = -40^\circ\text{C}$ to 25°C	-30	± 4.3	30	mV
FAULT CHARACTERISTICS						
FAULT Operating Point	I_{FAULT}		-	$\pm 1 \times I_{PR}$	-	A

[1] Typical values are mean ± 3 sigma values, except for lifetime drift, which are the average value including drift (from the worst case stress) after AEC-Q100 qualification.

[2] Percentage of I_P .

[3] A single device will not have both the maximum/minimum sensitivity error and maximum/minimum offset voltage, as that would violate the maximum/minimum total output error specification.

[4] Lifetime drift characteristics are based on AEC-Q100 qualification results.

[5] All devices stayed within min/max limits throughout AEC-Q100 qualification. The worst drift observed was 6.1%.

[6] All devices stayed within min/max limits throughout AEC-Q100 qualification. The worst drift observed was 4%.

[7] All devices stayed within min/max limits throughout AEC-Q100 qualification. The worst drift observed was 22 mV.

ACS71240KEXBLT-050B3-120 Variant

Characteristic	Symbol	Test Conditions	Min.	Typ. [1]	Max.	Unit
NON-STANDARD FAULT CHARACTERISTICS						
FAULT Operating Point	I_{FAULT}		-	$\pm 1.2 \times I_{PR}$	-	A

[1] Typical values are mean ± 3 sigma values

ACS71240KEXBLT-010B5 PERFORMANCE CHARACTERISTICS: Over full range of T_A , $V_{CC} = 5.0\text{ V}$, unless otherwise specified

Characteristic	Symbol	Test Conditions	Min.	Typ. [1]	Max.	Unit
NOMINAL PERFORMANCE						
Optimized Sensing Range	I_{PR}		-10	-	10	A
Sensitivity	Sens	$I_{PR(min)} < I_P < I_{PR(max)}$	-	200	-	mV/A
Zero-Current Output Voltage	$V_{IOUT(Q)}$	Bidirectional, $I_P = 0\text{ A}$	-	2.5	-	V
ACCURACY PERFORMANCE						
Total Output Error [2]	E_{TOT}	$I_P = 10\text{ A}$, $T_A = 25^\circ\text{C}$ to 125°C	-2.5	± 1.2	2.5	%
		$I_P = 10\text{ A}$, $T_A = -40^\circ\text{C}$ to 25°C	-6	± 2.4	6	%
TOTAL OUTPUT ERROR COMPONENTS [3] $E_{TOT} = E_{SENS} + 100 \times V_{OE} / (\text{Sens} \times I_P)$						
Sensitivity Error	E_{SENS}	$I_P = 10\text{ A}$, $T_A = 25^\circ\text{C}$ to 125°C	-2	± 0.8	2	%
		$I_P = 10\text{ A}$, $T_A = -40^\circ\text{C}$ to 25°C	-5.5	± 2.5	5.5	%
Offset Voltage Error	V_{OE}	$I_P = 0\text{ A}$, $T_A = 25^\circ\text{C}$ to 125°C	-15	± 4.4	15	mV
		$I_P = 0\text{ A}$, $T_A = -40^\circ\text{C}$ to 25°C	-30	± 9.6	30	mV
ACCURACY PERFORMANCE INCLUDING LIFETIME DRIFT [4]						
Total Output Error Including Lifetime Drift [5]	E_{TOT_drift}	$I_P = 10\text{ A}$, $T_A = 25^\circ\text{C}$ to 125°C	-5.7	± 1.8	5.7	%
		$I_P = 10\text{ A}$, $T_A = -40^\circ\text{C}$ to 25°C	-6	± 1.5	6	%
Sensitivity Error Including Lifetime Drift [6]	E_{SENS_drift}	$I_P = 10\text{ A}$, $T_A = 25^\circ\text{C}$ to 125°C	-5.1	± 1.2	5.1	%
		$I_P = 10\text{ A}$, $T_A = -40^\circ\text{C}$ to 25°C	-5.6	± 1.2	5.6	%
Offset Voltage Error Including Lifetime Drift [7]	V_{OE_drift}	$I_P = 0\text{ A}$, $T_A = 25^\circ\text{C}$ to 125°C	-28	± 4.5	28	mV
		$I_P = 0\text{ A}$, $T_A = -40^\circ\text{C}$ to 25°C	-30	± 4.3	30	mV
FAULT CHARACTERISTICS						
FAULT Operating Point	I_{FAULT}		-	$\pm 1 \times I_{PR}$	-	A

[1] Typical values are mean ± 3 sigma values, except for lifetime drift, which are the average value including drift (from the worst case stress) after AEC-Q100 qualification.

[2] Percentage of I_P .

[3] A single device will not have both the maximum/minimum sensitivity error and maximum/minimum offset voltage, as that would violate the maximum/minimum total output error specification.

[4] Lifetime drift characteristics are based on AEC-Q100 qualification results.

[5] All devices stayed within min/max limits throughout AEC-Q100 qualification. The worst drift observed was 6.1%.

[6] All devices stayed within min/max limits throughout AEC-Q100 qualification. The worst drift observed was 4%.

[7] All devices stayed within min/max limits throughout AEC-Q100 qualification. The worst drift observed was 22 mV.

ACS71240KEXBLT-020B5 PERFORMANCE CHARACTERISTICS: Over full range of T_A , $V_{CC} = 5.0\text{ V}$, unless otherwise specified

Characteristic	Symbol	Test Conditions	Min.	Typ. [1]	Max.	Unit
NOMINAL PERFORMANCE						
Optimized Sensing Range	I_{PR}		-20	-	20	A
Sensitivity	Sens	$I_{PR(min)} < I_P < I_{PR(max)}$	-	100	-	mV/A
Zero-Current Output Voltage	$V_{IOUT(Q)}$	Bidirectional, $I_P = 0\text{ A}$	-	2.5	-	V
ACCURACY PERFORMANCE						
Total Output Error [2]	E_{TOT}	$I_P = 10\text{ A}$, $T_A = 25^\circ\text{C}$ to 125°C	-2.5	± 1.1	2.5	%
		$I_P = 10\text{ A}$, $T_A = -40^\circ\text{C}$ to 25°C	-6	± 1.7	6	%
TOTAL OUTPUT ERROR COMPONENTS [3] $E_{TOT} = E_{SENS} + 100 \times V_{OE} / (\text{Sens} \times I_P)$						
Sensitivity Error	E_{SENS}	$I_P = 10\text{ A}$, $T_A = 25^\circ\text{C}$ to 125°C	-2	± 1.1	2	%
		$I_P = 10\text{ A}$, $T_A = -40^\circ\text{C}$ to 25°C	-5.5	± 2.0	5.5	%
Offset Voltage Error	V_{OE}	$I_P = 0\text{ A}$, $T_A = 25^\circ\text{C}$ to 125°C	-10	± 3.8	10	mV
		$I_P = 0\text{ A}$, $T_A = -40^\circ\text{C}$ to 25°C	-30	± 11	30	mV
ACCURACY PERFORMANCE INCLUDING LIFETIME DRIFT [4]						
Total Output Error Including Lifetime Drift [5]	E_{TOT_drift}	$I_P = 10\text{ A}$, $T_A = 25^\circ\text{C}$ to 125°C	-5.7	± 1.8	5.7	%
		$I_P = 10\text{ A}$, $T_A = -40^\circ\text{C}$ to 25°C	-6	± 1.5	6	%
Sensitivity Error Including Lifetime Drift [6]	E_{SENS_drift}	$I_P = 10\text{ A}$, $T_A = 25^\circ\text{C}$ to 125°C	-5.1	± 1.2	5.1	%
		$I_P = 10\text{ A}$, $T_A = -40^\circ\text{C}$ to 25°C	-5.6	± 1.2	5.6	%
Offset Voltage Error Including Lifetime Drift [7]	V_{OE_drift}	$I_P = 0\text{ A}$, $T_A = 25^\circ\text{C}$ to 125°C	-28	± 4.5	28	mV
		$I_P = 0\text{ A}$, $T_A = -40^\circ\text{C}$ to 25°C	-30	± 4.3	30	mV
FAULT CHARACTERISTICS						
FAULT Operating Point	I_{FAULT}		-	$\pm 1 \times I_{PR}$	-	A

[1] Typical values are mean ± 3 sigma values, except for lifetime drift, which are the average value including drift (from the worst case stress) after AEC-Q100 qualification.

[2] Percentage of I_P .

[3] A single device will not have both the maximum/minimum sensitivity error and maximum/minimum offset voltage, as that would violate the maximum/minimum total output error specification.

[4] Lifetime drift characteristics are based on AEC-Q100 qualification results.

[5] All devices stayed within min/max limits throughout AEC-Q100 qualification. The worst drift observed was 6.1%.

[6] All devices stayed within min/max limits throughout AEC-Q100 qualification. The worst drift observed was 4%.

[7] All devices stayed within min/max limits throughout AEC-Q100 qualification. The worst drift observed was 22 mV.

ACS71240KEXBLT-020B5-150L Variant

Characteristic	Symbol	Test Conditions	Min.	Typ. [1]	Max.	Unit
NON-STANDARD FAULT CHARACTERISTICS						
FAULT Operating Point	I_{FAULT}		-	$\pm 1.5 \times I_{PR}$	-	A
Fault Latch	-		Enabled			-

[1] Typical values are mean ± 3 sigma values

ACS71240

Automotive-Grade, Galvanically Isolated Current Sensor IC with Common-Mode Field Rejection and Overcurrent Detection in Small Footprint Low-Profile Packages

ACS71240KEXBLT-030B5 PERFORMANCE CHARACTERISTICS: Over full range of T_A , $V_{CC} = 5.0\text{ V}$, unless otherwise specified

Characteristic	Symbol	Test Conditions	Min.	Typ. [1]	Max.	Unit
NOMINAL PERFORMANCE						
Optimized Sensing Range	I_{PR}		-30	-	30	A
Sensitivity	Sens	$I_{PR(min)} < I_P < I_{PR(max)}$	-	66	-	mV/A
Zero-Current Output Voltage	$V_{IOUT(Q)}$	Bidirectional, $I_P = 0\text{ A}$	-	2.5	-	V
ACCURACY PERFORMANCE						
Total Output Error [2]	E_{TOT}	$I_P = 10\text{ A}$, $T_A = 25^\circ\text{C}$ to 125°C	-2.5	± 1.2	2.5	%
		$I_P = 10\text{ A}$, $T_A = -40^\circ\text{C}$ to 25°C	-6	± 2.2	6	%
TOTAL OUTPUT ERROR COMPONENTS [3] $E_{TOT} = E_{SENS} + 100 \times V_{OE} / (\text{Sens} \times I_P)$						
Sensitivity Error	E_{SENS}	$I_P = 10\text{ A}$, $T_A = 25^\circ\text{C}$ to 125°C	-2	± 0.9	2	%
		$I_P = 10\text{ A}$, $T_A = -40^\circ\text{C}$ to 25°C	-5.5	± 1.5	5.5	%
Voltage Offset Error	V_{OE}	$I_P = 0\text{ A}$, $T_A = 25^\circ\text{C}$ to 125°C	-15	± 3.7	15	mV
		$I_P = 0\text{ A}$, $T_A = -40^\circ\text{C}$ to 25°C	-30	± 7.1	30	mV
ACCURACY PERFORMANCE INCLUDING LIFETIME DRIFT [4]						
Total Output Error Including Lifetime Drift [5]	E_{TOT_drift}	$I_P = 10\text{ A}$, $T_A = 25^\circ\text{C}$ to 125°C	-5.7	± 1.8	5.7	%
		$I_P = 10\text{ A}$, $T_A = -40^\circ\text{C}$ to 25°C	-6	± 1.5	6	%
Sensitivity Error Including Lifetime Drift [6]	E_{SENS_drift}	$I_P = 10\text{ A}$, $T_A = 25^\circ\text{C}$ to 125°C	-5.1	± 1.2	5.1	%
		$I_P = 10\text{ A}$, $T_A = -40^\circ\text{C}$ to 25°C	-5.6	± 1.2	5.6	%
Offset Voltage Error Including Lifetime Drift [7]	V_{OE_drift}	$I_P = 0\text{ A}$, $T_A = 25^\circ\text{C}$ to 125°C	-28	± 4.5	28	mV
		$I_P = 0\text{ A}$, $T_A = -40^\circ\text{C}$ to 25°C	-30	± 4.3	30	mV
FAULT CHARACTERISTICS						
FAULT Operating Point	I_{FAULT}		-	$\pm 1 \times I_{PR}$	-	A

[1] Typical values are mean ± 3 sigma values, except for lifetime drift, which are the average value including drift (from the worst case stress) after AEC-Q100 qualification.

[2] Percentage of I_P .

[3] A single device will not have both the maximum/minimum sensitivity error and maximum/minimum offset voltage, as that would violate the maximum/minimum total output error specification.

[4] Lifetime drift characteristics are based on AEC-Q100 qualification results.

[5] All devices stayed within min/max limits throughout AEC-Q100 qualification. The worst drift observed was 6.1%.

[6] All devices stayed within min/max limits throughout AEC-Q100 qualification. The worst drift observed was 4%.

[7] All devices stayed within min/max limits throughout AEC-Q100 qualification. The worst drift observed was 22 mV.

ACS71240

Automotive-Grade, Galvanically Isolated Current Sensor IC with Common-Mode Field Rejection and Overcurrent Detection in Small Footprint Low-Profile Packages

ACS71240KEXBLT-045B5 PERFORMANCE CHARACTERISTICS: Over full range of T_A , $V_{CC} = 5.0$ V, unless otherwise specified

Characteristic	Symbol	Test Conditions	Min.	Typ. [1]	Max.	Unit
NOMINAL PERFORMANCE						
Optimized Sensing Range	I_{PR}		-45	-	45	A
Sensitivity	Sens	$I_{PR(min)} < I_P < I_{PR(max)}$	-	44.4	-	mV/A
Zero-Current Output Voltage	$V_{IOUT(Q)}$	Bidirectional, $I_P = 0$ A	-	2.5	-	V
ACCURACY PERFORMANCE						
Total Output Error [2]	E_{TOT}	$I_P = 10$ A, $T_A = 25^\circ\text{C}$ to 125°C	-2.5	± 1.5	2.5	%
		$I_P = 10$ A, $T_A = -40^\circ\text{C}$ to 25°C	-6	± 2.5	6	%
TOTAL OUTPUT ERROR COMPONENTS [3] $E_{TOT} = E_{SENS} + 100 \times V_{OE} / (\text{Sens} \times I_P)$						
Sensitivity Error	E_{SENS}	$I_P = 10$ A, $T_A = 25^\circ\text{C}$ to 125°C	-2	± 1.2	2	%
		$I_P = 10$ A, $T_A = -40^\circ\text{C}$ to 25°C	-5.5	± 1.3	5.5	%
Voltage Offset Error	V_{OE}	$I_P = 0$ A, $T_A = 25^\circ\text{C}$ to 125°C	-15	± 4	15	mV
		$I_P = 0$ A, $T_A = -40^\circ\text{C}$ to 25°C	-30	± 10	30	mV
ACCURACY PERFORMANCE INCLUDING LIFETIME DRIFT [4]						
Total Output Error Including Lifetime Drift [5]	E_{TOT_drift}	$I_P = 10$ A, $T_A = 25^\circ\text{C}$ to 125°C	-5.7	± 1.8	5.7	%
		$I_P = 10$ A, $T_A = -40^\circ\text{C}$ to 25°C	-6	± 1.5	6	%
Sensitivity Error Including Lifetime Drift [6]	E_{SENS_drift}	$I_P = 10$ A, $T_A = 25^\circ\text{C}$ to 125°C	-5.1	± 1.2	5.1	%
		$I_P = 10$ A, $T_A = -40^\circ\text{C}$ to 25°C	-5.6	± 1.2	5.6	%
Offset Voltage Error Including Lifetime Drift [7]	V_{OE_drift}	$I_P = 0$ A, $T_A = 25^\circ\text{C}$ to 125°C	-28	± 4.5	28	mV
		$I_P = 0$ A, $T_A = -40^\circ\text{C}$ to 25°C	-30	± 4.3	30	mV
FAULT CHARACTERISTICS						
FAULT Operating Point	I_{FAULT}		-	$\pm 1 \times I_{PR}$	-	A

[1] Typical values are mean ± 3 sigma values, except for lifetime drift, which are the average value including drift (from the worst case stress) after AEC-Q100 qualification.

[2] Percentage of I_P .

[3] A single device will not have both the maximum/minimum sensitivity error and maximum/minimum offset voltage, as that would violate the maximum/minimum total output error specification.

[4] Lifetime drift characteristics are based on AEC-Q100 qualification results.

[5] All devices stayed within min/max limits throughout AEC-Q100 qualification. The worst drift observed was 6.1%.

[6] All devices stayed within min/max limits throughout AEC-Q100 qualification. The worst drift observed was 4%.

[7] All devices stayed within min/max limits throughout AEC-Q100 qualification. The worst drift observed was 22 mV.

ACS71240

Automotive-Grade, Galvanically Isolated Current Sensor IC with Common-Mode Field Rejection and Overcurrent Detection in Small Footprint Low-Profile Packages

ACS71240KEXBLT-050B5 PERFORMANCE CHARACTERISTICS: Over full range of T_A , $V_{CC} = 5.0$ V, unless otherwise specified

Characteristic	Symbol	Test Conditions	Min.	Typ. [1]	Max.	Unit
NOMINAL PERFORMANCE						
Optimized Sensing Range	I_{PR}		-50	-	50	A
Sensitivity	Sens	$I_{PR(min)} < I_P < I_{PR(max)}$	-	40	-	mV/A
Zero-Current Output Voltage	$V_{IOUT(Q)}$	Bidirectional, $I_P = 0$ A	-	2.5	-	V
ACCURACY PERFORMANCE						
Total Output Error [2]	E_{TOT}	$I_P = 10$ A, $T_A = 25^\circ\text{C}$ to 125°C	-2.5	± 1.4	2.5	%
		$I_P = 10$ A, $T_A = -40^\circ\text{C}$ to 25°C	-6	± 2.6	6	%
TOTAL OUTPUT ERROR COMPONENTS [3] $E_{TOT} = E_{SENS} + 100 \times V_{OE} / (\text{Sens} \times I_P)$						
Sensitivity Error	E_{SENS}	$I_P = 10$ A, $T_A = 25^\circ\text{C}$ to 125°C	-2	± 1.1	2	%
		$I_P = 10$ A, $T_A = -40^\circ\text{C}$ to 25°C	-5.5	± 1.7	5.5	%
Voltage Offset Error	V_{OE}	$I_P = 0$ A, $T_A = 25^\circ\text{C}$ to 125°C	-15	± 3	15	mV
		$I_P = 0$ A, $T_A = -40^\circ\text{C}$ to 25°C	-30	± 8	30	mV
ACCURACY PERFORMANCE INCLUDING LIFETIME DRIFT [4]						
Total Output Error Including Lifetime Drift [5]	E_{TOT_drift}	$I_P = 10$ A, $T_A = 25^\circ\text{C}$ to 125°C	-5.7	± 1.8	5.7	%
		$I_P = 10$ A, $T_A = -40^\circ\text{C}$ to 25°C	-6	± 1.5	6	%
Sensitivity Error Including Lifetime Drift [6]	E_{SENS_drift}	$I_P = 10$ A, $T_A = 25^\circ\text{C}$ to 125°C	-5.1	± 1.2	5.1	%
		$I_P = 10$ A, $T_A = -40^\circ\text{C}$ to 25°C	-5.6	± 1.2	5.6	%
Offset Voltage Error Including Lifetime Drift [7]	V_{OE_drift}	$I_P = 0$ A, $T_A = 25^\circ\text{C}$ to 125°C	-28	± 4.5	28	mV
		$I_P = 0$ A, $T_A = -40^\circ\text{C}$ to 25°C	-30	± 4.3	30	mV
FAULT CHARACTERISTICS						
FAULT Operating Point	I_{FAULT}		-	$\pm 1 \times I_{PR}$	-	A

[1] Typical values are mean ± 3 sigma values, except for lifetime drift, which are the average value including drift (from the worst case stress) after AEC-Q100 qualification.

[2] Percentage of I_P .

[3] A single device will not have both the maximum/minimum sensitivity error and maximum/minimum offset voltage, as that would violate the maximum/minimum total output error specification.

[4] Lifetime drift characteristics are based on AEC-Q100 qualification results.

[5] All devices stayed within min/max limits throughout AEC-Q100 qualification. The worst drift observed was 6.1%.

[6] All devices stayed within min/max limits throughout AEC-Q100 qualification. The worst drift observed was 4%.

[7] All devices stayed within min/max limits throughout AEC-Q100 qualification. The worst drift observed was 22 mV.

ACS71240

Automotive-Grade, Galvanically Isolated Current Sensor IC with Common-Mode Field Rejection and Overcurrent Detection in Small Footprint Low-Profile Packages

ACS71240KEXBLT-050U5 PERFORMANCE CHARACTERISTICS: Over full range of T_A , $V_{CC} = 5.0\text{ V}$, unless otherwise specified

Characteristic	Symbol	Test Conditions	Min.	Typ. [1]	Max.	Unit
NOMINAL PERFORMANCE						
Optimized Sensing Range	I_{PR}		0	–	50	A
Sensitivity	Sens	$I_{PR(min)} < I_P < I_{PR(max)}$	–	80	–	mV/A
Zero-Current Output Voltage	$V_{IOUT(Q)}$	Unidirectional, $I_P = 0\text{ A}$	–	0.5	–	V
ACCURACY PERFORMANCE						
Total Output Error [2]	E_{TOT}	$I_P = 10\text{ A}$, $T_A = 25^\circ\text{C}$ to 125°C	–2.5	± 1.2	2.5	%
		$I_P = 10\text{ A}$, $T_A = -40^\circ\text{C}$ to 25°C	–6	± 3.6	6	%
TOTAL OUTPUT ERROR COMPONENTS [3] $E_{TOT} = E_{SENS} + 100 \times V_{OE} / (\text{Sens} \times I_P)$						
Sensitivity Error	E_{SENS}	$I_P = 10\text{ A}$, $T_A = 25^\circ\text{C}$ to 125°C	–2	± 0.9	2	%
		$I_P = 10\text{ A}$, $T_A = -40^\circ\text{C}$ to 25°C	–5.5	± 3.3	5.5	%
Voltage Offset Error	V_{OE}	$I_P = 0\text{ A}$, $T_A = 25^\circ\text{C}$ to 125°C	–10	± 4.6	10	mV
		$I_P = 0\text{ A}$, $T_A = -40^\circ\text{C}$ to 25°C	–30	± 6.3	30	mV
ACCURACY PERFORMANCE INCLUDING LIFETIME DRIFT [4]						
Total Output Error Including Lifetime Drift [5]	E_{TOT_drift}	$I_P = 10\text{ A}$, $T_A = 25^\circ\text{C}$ to 125°C	–5.7	± 1.8	5.7	%
		$I_P = 10\text{ A}$, $T_A = -40^\circ\text{C}$ to 25°C	–6	± 1.5	6	%
Sensitivity Error Including Lifetime Drift [6]	E_{SENS_drift}	$I_P = 10\text{ A}$, $T_A = 25^\circ\text{C}$ to 125°C	–5.1	± 1.2	5.1	%
		$I_P = 10\text{ A}$, $T_A = -40^\circ\text{C}$ to 25°C	–5.6	± 1.2	5.6	%
Offset Voltage Error Including Lifetime Drift [7]	V_{OE_drift}	$I_P = 0\text{ A}$, $T_A = 25^\circ\text{C}$ to 125°C	–28	± 4.5	28	mV
		$I_P = 0\text{ A}$, $T_A = -40^\circ\text{C}$ to 25°C	–30	± 4.3	30	mV
FAULT CHARACTERISTICS						
FAULT Operating Point	I_{FAULT}		–	$\pm 1 \times I_{PR}$	–	A

[1] Typical values are mean ± 3 sigma values, except for lifetime drift, which are the average value including drift (from the worst case stress) after AEC-Q100 qualification.

[2] Percentage of I_P .

[3] A single device will not have both the maximum/minimum sensitivity error and maximum/minimum offset voltage, as that would violate the maximum/minimum total output error specification.

[4] Lifetime drift characteristics are based on AEC-Q100 qualification results.

[5] All devices stayed within min/max limits throughout AEC-Q100 qualification. The worst drift observed was 6.1%.

[6] All devices stayed within min/max limits throughout AEC-Q100 qualification. The worst drift observed was 4%.

[7] All devices stayed within min/max limits throughout AEC-Q100 qualification. The worst drift observed was 22 mV.

ACS71240LLCBTR-010B3 PERFORMANCE CHARACTERISTICS: Over full range of T_A , $V_{CC} = 3.3$ V, unless otherwise specified

Characteristic	Symbol	Test Conditions	Min.	Typ. [1]	Max.	Unit
NOMINAL PERFORMANCE						
Optimized Sensing Range	I_{PR}		-10	-	10	A
Sensitivity	Sens	$I_{PR(min)} < I_P < I_{PR(max)}$	-	132	-	mV/A
Zero-Current Output Voltage	$V_{IOUT(Q)}$	Bidirectional, $I_P = 0$ A	-	1.65	-	V
ACCURACY PERFORMANCE						
Total Output Error [2]	E_{TOT}	$I_P = I_{PR(max)}$, $T_A = 25^\circ\text{C}$ to 150°C	-2	± 1	2	%
		$I_P = I_{PR(max)}$, $T_A = -40^\circ\text{C}$ to 25°C	-6	± 2.4	6	%
TOTAL OUTPUT ERROR COMPONENTS [3] $E_{TOT} = E_{SENS} + 100 \times V_{OE} / (\text{Sens} \times I_P)$						
Sensitivity Error	E_{SENS}	$I_P = I_{PR(max)}$, $T_A = 25^\circ\text{C}$ to 150°C	-1.5	± 0.8	1.5	%
		$I_P = I_{PR(max)}$, $T_A = -40^\circ\text{C}$ to 25°C	-5.5	± 2.3	5.5	%
Voltage Offset Error	V_{OE}	$I_P = 0$ A, $T_A = 25^\circ\text{C}$ to 150°C	-10	± 6.7	10	mV
		$I_P = 0$ A, $T_A = -40^\circ\text{C}$ to 25°C	-30	± 10	30	mV
FAULT CHARACTERISTICS						
FAULT Operating Point	I_{FAULT}		-	$\pm 1 \times I_{PR}$	-	A

[1] Typical values are mean ± 3 sigma values. Limits include lifetime as tested during AEC-Q100 qualification.

[2] Percentage of I_P , with $I_P = I_{PR(max)}$.

[3] A single device will not have both the maximum/minimum sensitivity error and maximum/minimum offset voltage, as that would violate the maximum/minimum total output error specification.

ACS71240LLCBTR-025B3 PERFORMANCE CHARACTERISTICS: Over full range of T_A , $V_{CC} = 3.3$ V, unless otherwise specified

Characteristic	Symbol	Test Conditions	Min.	Typ. [1]	Max.	Unit
NOMINAL PERFORMANCE						
Optimized Sensing Range	I_{PR}		-25	-	25	A
Sensitivity	Sens	$I_{PR(min)} < I_P < I_{PR(max)}$	-	55	-	mV/A
Zero-Current Output Voltage	$V_{IOUT(Q)}$	Bidirectional, $I_P = 0$ A	-	1.65	-	V
ACCURACY PERFORMANCE						
Total Output Error [2]	E_{TOT}	$I_P = I_{PR(max)}$, $T_A = 25^\circ\text{C}$ to 150°C	-2	± 1	2	%
		$I_P = I_{PR(max)}$, $T_A = -40^\circ\text{C}$ to 25°C	-6	± 1.7	6	%
TOTAL OUTPUT ERROR COMPONENTS [3] $E_{TOT} = E_{SENS} + 100 \times V_{OE} / (\text{Sens} \times I_P)$						
Sensitivity Error	E_{SENS}	$I_P = I_{PR(max)}$, $T_A = 25^\circ\text{C}$ to 150°C	-1.9	± 0.9	1.9	%
		$I_P = I_{PR(max)}$, $T_A = -40^\circ\text{C}$ to 25°C	-5.5	± 1.4	5.5	%
Voltage Offset Error	V_{OE}	$I_P = 0$ A, $T_A = 25^\circ\text{C}$ to 150°C	-10	± 7	10	mV
		$I_P = 0$ A, $T_A = -40^\circ\text{C}$ to 25°C	-30	± 11	30	mV
FAULT CHARACTERISTICS						
FAULT Operating Point	I_{FAULT}		-	$\pm 1 \times I_{PR}$	-	A

[1] Typical values are mean ± 3 sigma values. Limits include lifetime as tested during AEC-Q100 qualification.

[2] Percentage of I_P , with $I_P = I_{PR(max)}$.

[3] A single device will not have both the maximum/minimum sensitivity error and maximum/minimum offset voltage, as that would violate the maximum/minimum total output error specification.

ACS71240LLCBTR-030B3 PERFORMANCE CHARACTERISTICS: Over full range of T_A , $V_{CC} = 3.3$ V, unless otherwise specified

Characteristic	Symbol	Test Conditions	Min.	Typ. [1]	Max.	Unit
NOMINAL PERFORMANCE						
Optimized Sensing Range	I_{PR}		-30	-	30	A
Sensitivity	Sens	$I_{PR(min)} < I_P < I_{PR(max)}$	-	44	-	mV/A
Zero-Current Output Voltage	$V_{IOUT(Q)}$	Bidirectional, $I_P = 0$ A	-	1.65	-	V
ACCURACY PERFORMANCE						
Total Output Error [2]	E_{TOT}	$I_P = I_{PR(max)}$, $T_A = 25^\circ\text{C}$ to 150°C	-2	± 0.6	2	%
		$I_P = I_{PR(max)}$, $T_A = -40^\circ\text{C}$ to 25°C	-6	± 1.4	6	%
TOTAL OUTPUT ERROR COMPONENTS [3] $E_{TOT} = E_{SENS} + 100 \times V_{OE} / (\text{Sens} \times I_P)$						
Sensitivity Error	E_{SENS}	$I_P = I_{PR(max)}$, $T_A = 25^\circ\text{C}$ to 150°C	-1.9	± 0.5	1.9	%
		$I_P = I_{PR(max)}$, $T_A = -40^\circ\text{C}$ to 25°C	-5.5	± 1.1	5.5	%
Voltage Offset Error	V_{OE}	$I_P = 0$ A, $T_A = 25^\circ\text{C}$ to 150°C	-10	± 7.2	10	mV
		$I_P = 0$ A, $T_A = -40^\circ\text{C}$ to 25°C	-30	± 9.5	30	mV
FAULT CHARACTERISTICS						
FAULT Operating Point	I_{FAULT}		-	$\pm 1 \times I_{PR}$	-	A

[1] Typical values are mean ± 3 sigma values. Limits include lifetime as tested during AEC-Q100 qualification.

[2] Percentage of I_P , with $I_P = I_{PR(max)}$.

[3] A single device will not have both the maximum/minimum sensitivity error and maximum/minimum offset voltage, as that would violate the maximum/minimum total output error specification.

ACS71240LLCBTR-050B3 PERFORMANCE CHARACTERISTICS: Over full range of T_A , $V_{CC} = 3.3$ V, unless otherwise specified

Characteristic	Symbol	Test Conditions	Min.	Typ. [1]	Max.	Unit
NOMINAL PERFORMANCE						
Optimized Sensing Range	I_{PR}		-50	-	50	A
Sensitivity	Sens	$I_{PR(min)} < I_P < I_{PR(max)}$	-	26.4	-	mV/A
Zero-Current Output Voltage	$V_{IOUT(Q)}$	Bidirectional, $I_P = 0$ A	-	1.65	-	V
ACCURACY PERFORMANCE						
Total Output Error [2]	E_{TOT}	$I_P = I_{PR(max)}$, $T_A = 25^\circ\text{C}$ to 150°C	-2	± 0.9	2	%
		$I_P = I_{PR(max)}$, $T_A = -40^\circ\text{C}$ to 25°C	-6	± 4.3	6	%
TOTAL OUTPUT ERROR COMPONENTS [3] $E_{TOT} = E_{SENS} + 100 \times V_{OE} / (\text{Sens} \times I_P)$						
Sensitivity Error	E_{SENS}	$I_P = I_{PR(max)}$, $T_A = 25^\circ\text{C}$ to 150°C	-1.5	± 0.8	1.5	%
		$I_P = I_{PR(max)}$, $T_A = -40^\circ\text{C}$ to 25°C	-5.5	± 4.2	5.5	%
Voltage Offset Error	V_{OE}	$I_P = 0$ A, $T_A = 25^\circ\text{C}$ to 150°C	-10	± 7.5	10	mV
		$I_P = 0$ A, $T_A = -40^\circ\text{C}$ to 25°C	-30	± 10	30	mV
FAULT CHARACTERISTICS						
FAULT Operating Point	I_{FAULT}		-	$\pm 1 \times I_{PR}$	-	A

[1] Typical values are mean ± 3 sigma values. Limits include lifetime as tested during AEC-Q100 qualification.

[2] Percentage of I_P , with $I_P = I_{PR(max)}$.

[3] A single device will not have both the maximum/minimum sensitivity error and maximum/minimum offset voltage, as that would violate the maximum/minimum total output error specification.

ACS71240LLCBTR-020U5 PERFORMANCE CHARACTERISTICS: Over full range of T_A , $V_{CC} = 5.0\text{ V}$, unless otherwise specified

Characteristic	Symbol	Test Conditions	Min.	Typ. [1]	Max.	Unit
NOMINAL PERFORMANCE						
Optimized Sensing Range	I_{PR}		0	–	20	A
Sensitivity	Sens	$I_{PR(min)} < I_P < I_{PR(max)}$	–	200	–	mV/A
Zero-Current Output Voltage	$V_{IOUT(Q)}$	Unidirectional, $I_P = 0\text{ A}$	–	0.5	–	V
ACCURACY PERFORMANCE						
Total Output Error [2]	E_{TOT}	$I_P = I_{PR(max)}$, $T_A = 25^\circ\text{C}$ to 150°C	–2	± 1	2	%
		$I_P = I_{PR(max)}$, $T_A = -40^\circ\text{C}$ to 25°C	–6	± 2.2	6	%
TOTAL OUTPUT ERROR COMPONENTS [3] $E_{TOT} = E_{SENS} + 100 \times V_{OE} / (\text{Sens} \times I_P)$						
Sensitivity Error	E_{SENS}	$I_P = I_{PR(max)}$, $T_A = 25^\circ\text{C}$ to 150°C	–1.9	± 1	1.9	%
		$I_P = I_{PR(max)}$, $T_A = -40^\circ\text{C}$ to 25°C	–5.5	± 1.9	5.5	%
Voltage Offset Error	V_{OE}	$I_P = 0\text{ A}$, $T_A = 25^\circ\text{C}$ to 150°C	–10	± 7.1	10	mV
		$I_P = 0\text{ A}$, $T_A = -40^\circ\text{C}$ to 25°C	–30	± 23	30	mV
FAULT CHARACTERISTICS						
FAULT Operating Point	I_{FAULT}		–	$\pm 1 \times I_{PR}$	–	A

[1] Typical values are mean ± 3 sigma values. Limits include lifetime as tested during AEC-Q100 qualification.

[2] Percentage of I_P , with $I_P = I_{PR(max)}$.

[3] A single device will not have both the maximum/minimum sensitivity error and maximum/minimum offset voltage, as that would violate the maximum/minimum total output error specification.

ACS71240LLCBTR-045B5 PERFORMANCE CHARACTERISTICS: Over full range of T_A , $V_{CC} = 5.0\text{ V}$, unless otherwise specified

Characteristic	Symbol	Test Conditions	Min.	Typ. [1]	Max.	Unit
NOMINAL PERFORMANCE						
Optimized Sensing Range	I_{PR}		–45	–	45	A
Sensitivity	Sens	$I_{PR(min)} < I_P < I_{PR(max)}$	–	44.4	–	mV/A
Zero-Current Output Voltage	$V_{IOUT(Q)}$	Bidirectional, $I_P = 0\text{ A}$	–	2.5	–	V
ACCURACY PERFORMANCE						
Total Output Error [2]	E_{TOT}	$I_P = I_{PR(max)}$, $T_A = 25^\circ\text{C}$ to 150°C	–2	± 0.7	2	%
		$I_P = I_{PR(max)}$, $T_A = -40^\circ\text{C}$ to 25°C	–6	± 1.4	6	%
TOTAL OUTPUT ERROR COMPONENTS [3] $E_{TOT} = E_{SENS} + 100 \times V_{OE} / (\text{Sens} \times I_P)$						
Sensitivity Error	E_{SENS}	$I_P = I_{PR(max)}$, $T_A = 25^\circ\text{C}$ to 150°C	–1.9	± 0.6	1.9	%
		$I_P = I_{PR(max)}$, $T_A = -40^\circ\text{C}$ to 25°C	–5.5	± 1.4	5.5	%
Voltage Offset Error	V_{OE}	$I_P = 0\text{ A}$, $T_A = 25^\circ\text{C}$ to 150°C	–10	± 6.9	10	mV
		$I_P = 0\text{ A}$, $T_A = -40^\circ\text{C}$ to 25°C	–30	± 7.2	30	mV
FAULT CHARACTERISTICS						
FAULT Operating Point	I_{FAULT}		–	$\pm 1 \times I_{PR}$	–	A

[1] Typical values are mean ± 3 sigma values. Limits include lifetime as tested during AEC-Q100 qualification.

[2] Percentage of I_P , with $I_P = I_{PR(max)}$.

[3] A single device will not have both the maximum/minimum sensitivity error and maximum/minimum offset voltage, as that would violate the maximum/minimum total output error specification.

ACS71240

Automotive-Grade, Galvanically Isolated Current Sensor IC with Common-Mode Field Rejection and Overcurrent Detection in Small Footprint Low-Profile Packages

ACS71240LLCBTR-050B5 PERFORMANCE CHARACTERISTICS: Over full range of T_A , $V_{CC} = 5.0$ V, unless otherwise specified

Characteristic	Symbol	Test Conditions	Min.	Typ. [1]	Max.	Unit
NOMINAL PERFORMANCE						
Optimized Sensing Range	I_{PR}		-50	-	50	A
Sensitivity	Sens	$I_{PR(min)} < I_P < I_{PR(max)}$	-	40	-	mV/A
Zero-Current Output Voltage	$V_{IOUT(Q)}$	Bidirectional, $I_P = 0$ A	-	2.5	-	V
ACCURACY PERFORMANCE						
Total Output Error [2]	E_{TOT}	$I_P = I_{PR(max)}$, $T_A = 25^\circ\text{C}$ to 150°C	-2	± 1.1	2	%
		$I_P = I_{PR(max)}$, $T_A = -40^\circ\text{C}$ to 25°C	-6	± 4	6	%
TOTAL OUTPUT ERROR COMPONENTS [3] $E_{TOT} = E_{SENS} + 100 \times V_{OE} / (\text{Sens} \times I_P)$						
Sensitivity Error	E_{SENS}	$I_P = I_{PR(max)}$, $T_A = 25^\circ\text{C}$ to 150°C	-1.9	± 1	1.9	%
		$I_P = I_{PR(max)}$, $T_A = -40^\circ\text{C}$ to 25°C	-5.5	± 4	5.5	%
Voltage Offset Error	V_{OE}	$I_P = 0$ A, $T_A = 25^\circ\text{C}$ to 150°C	-10	± 7.7	10	mV
		$I_P = 0$ A, $T_A = -40^\circ\text{C}$ to 25°C	-30	± 7.5	30	mV
FAULT CHARACTERISTICS						
FAULT Operating Point	I_{FAULT}		-	$\pm 1 \times I_{PR}$	-	A

[1] Typical values are mean ± 3 sigma values. Limits include lifetime as tested during AEC-Q100 qualification.

[2] Percentage of I_P , with $I_P = I_{PR(max)}$.

[3] A single device will not have both the maximum/minimum sensitivity error and maximum/minimum offset voltage, as that would violate the maximum/minimum total output error specification.

ACS71240LLCBTR-050U5 PERFORMANCE CHARACTERISTICS: Over full range of T_A , $V_{CC} = 5.0$ V, unless otherwise specified

Characteristic	Symbol	Test Conditions	Min.	Typ. [1]	Max.	Unit
NOMINAL PERFORMANCE						
Optimized Sensing Range	I_{PR}		0	-	50	A
Sensitivity	Sens	$I_{PR(min)} < I_P < I_{PR(max)}$	-	80	-	mV/A
Zero-Current Output Voltage	$V_{IOUT(Q)}$	Unidirectional, $I_P = 0$ A	-	0.5	-	V
ACCURACY PERFORMANCE						
Total Output Error [2]	E_{TOT}	$I_P = I_{PR(max)}$, $T_A = 25^\circ\text{C}$ to 150°C	-2	± 1.1	2	%
		$I_P = I_{PR(max)}$, $T_A = -40^\circ\text{C}$ to 25°C	-6	± 3.8	6	%
TOTAL OUTPUT ERROR COMPONENTS [3] $E_{TOT} = E_{SENS} + 100 \times V_{OE} / (\text{Sens} \times I_P)$						
Sensitivity Error	E_{SENS}	$I_P = I_{PR(max)}$, $T_A = 25^\circ\text{C}$ to 150°C	-1.9	± 1.1	1.9	%
		$I_P = I_{PR(max)}$, $T_A = -40^\circ\text{C}$ to 25°C	-5.5	± 3.8	5.5	%
Voltage Offset Error	V_{OE}	$I_P = 0$ A, $T_A = 25^\circ\text{C}$ to 150°C	-10	± 4	10	mV
		$I_P = 0$ A, $T_A = -40^\circ\text{C}$ to 25°C	-30	± 5.5	30	mV
FAULT CHARACTERISTICS						
FAULT Operating Point	I_{FAULT}		-	$\pm 1 \times I_{PR}$	-	A

[1] Typical values are mean ± 3 sigma values. Limits include lifetime as tested during AEC-Q100 qualification.

[2] Percentage of I_P , with $I_P = I_{PR(max)}$.

[3] A single device will not have both the maximum/minimum sensitivity error and maximum/minimum offset voltage, as that would violate the maximum/minimum total output error specification.

CHARACTERISTIC PERFORMANCE
ACS71240 TYPICAL FREQUENCY RESPONSE

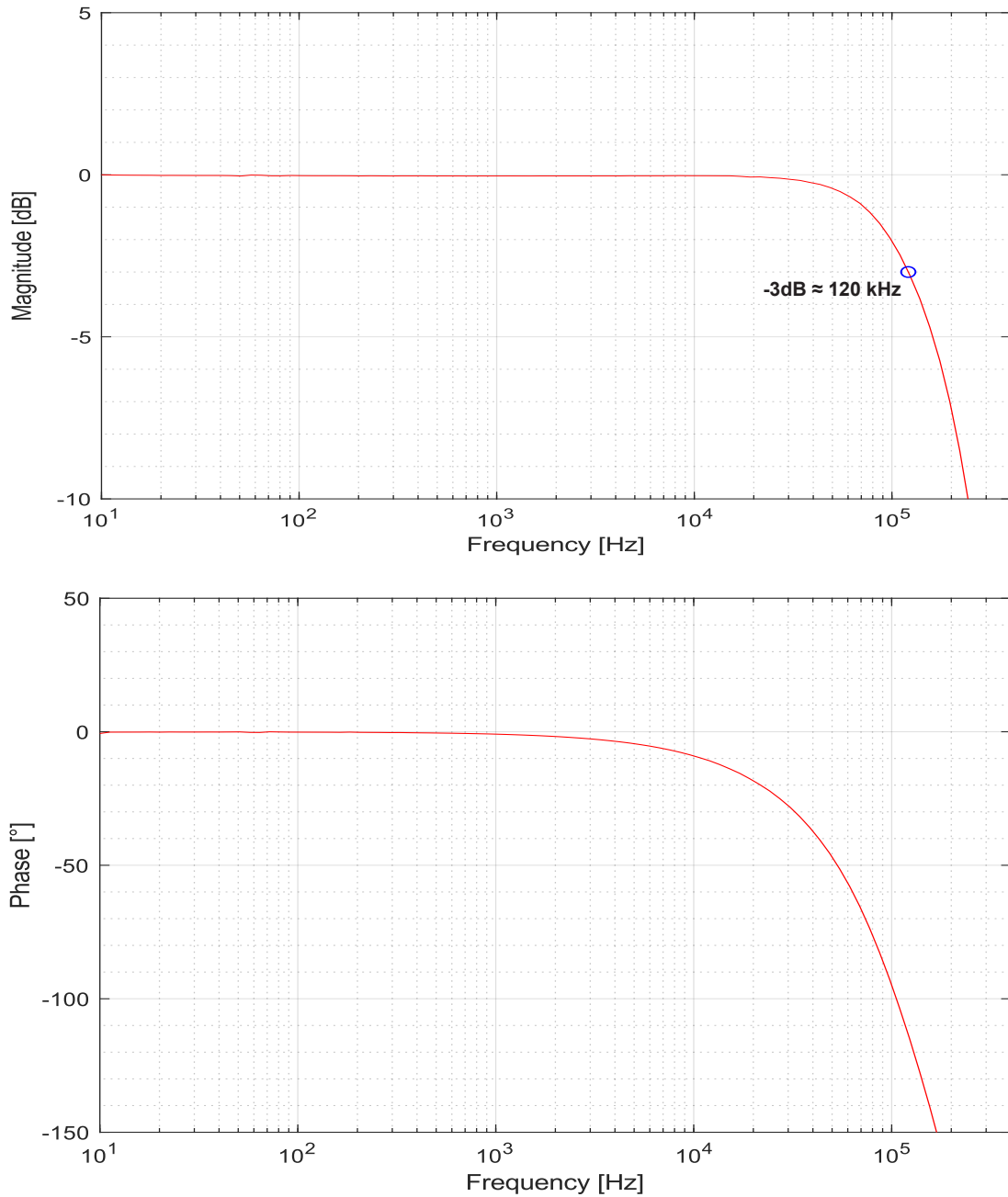

For information regarding bandwidth characterization methods used for the ACS71240, see the “Characterizing System Bandwidth” application note (<https://allegromicro.com/en/insights-and-innovations/technical-documents/hall-effect-sensor-ic-publications/an-effective-method-for-characterizing-system-bandwidth-an296169>) on the Allegro website.

RESPONSE CHARACTERISTICS DEFINITIONS AND PERFORMANCE DATA

Response Time ($t_{RESPONSE}$)

The time interval between a) when the sensed input current reaches 90% of its final value, and b) when the sensor output reaches 90% of its full-scale value.

Propagation Delay (t_{pd})

The time interval between a) when the sensed input current reaches 20% of its full-scale value, and b) when the sensor output reaches 20% of its full-scale value.

Rise Time (t_r)

The time interval between a) when the sensor reaches 10% of its full-scale value, and b) when it reaches 90% of its full-scale value.

Output Slew Rate (SR)

The rate of change [V/ μ s] in the output voltage from a) when the sensor reaches 10% of its full-scale value, and b) when it reaches 90% of its full-scale value.

Response Time, Propagation Delay, Rise Time, and Output Slew Rate

Applied current step with 10%-90% rise time = 1 μ s

Test Conditions: $T_A = 25^\circ\text{C}$, $C_{BYPASS} = 0.1 \mu\text{F}$, $C_L = 1 \text{nF}$

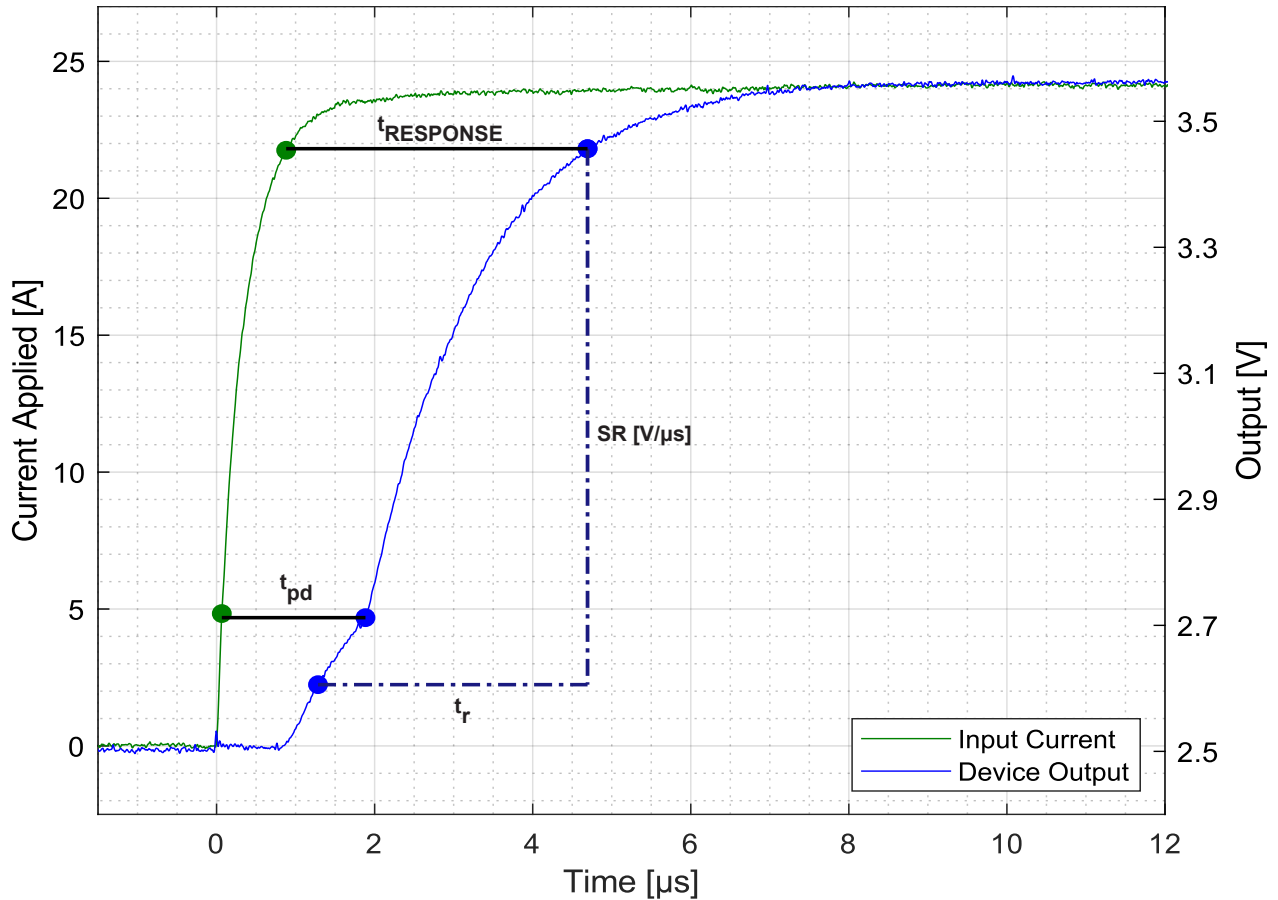

POWER ON FUNCTIONAL DESCRIPTION AND PERFORMANCE DATA

Power-On Time (t_{PO})

When the supply is ramped to its operating voltage, the device requires a finite amount of time to power its internal components before responding to an input magnetic field. Power-On Time (t_{PO}) is defined as the time interval between a) the power supply has reached its minimum specified operating voltage ($V_{CC(min)}$), and b) when the sensor output has settled within $\pm 10\%$ of its steady-state value under an applied magnetic field.

Power-On Profile

After applying power, the part remains off in a known, high impedance state referred to as Power-on Reset, or POR. The device stays in this state until the voltage reaches a point at which the device will remain powered. The power-on profile below illustrates the intended power on/off. A pull-down resistor was used on the output of the tested device.

Power-On Time (t_{PO})

Test Conditions: $T_A = 25^\circ\text{C}$, $C_{BYPASS} = 0.1 \mu\text{F}$, $R_{PD} = 10 \text{ k}\Omega$,
1V Output Swing

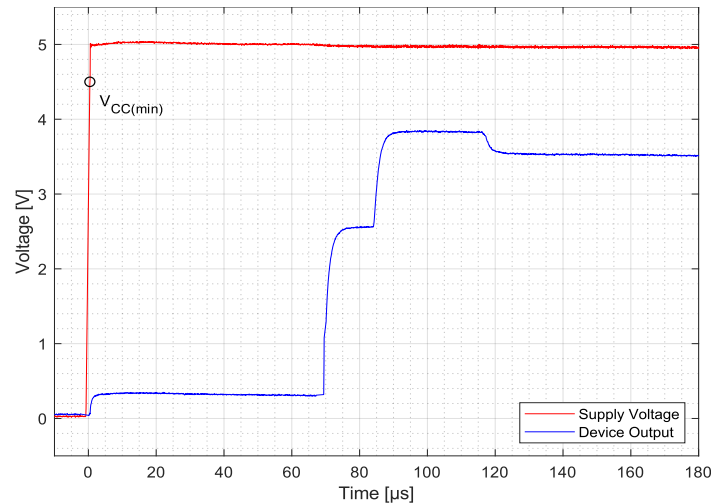

Power-On Profile

Supply voltage ramp rate = 1V/ms

Test Conditions: $T_A = 25^\circ\text{C}$, $C_{BYPASS} = 0.1 \mu\text{F}$, $R_{PD} = 10 \text{ k}\Omega$

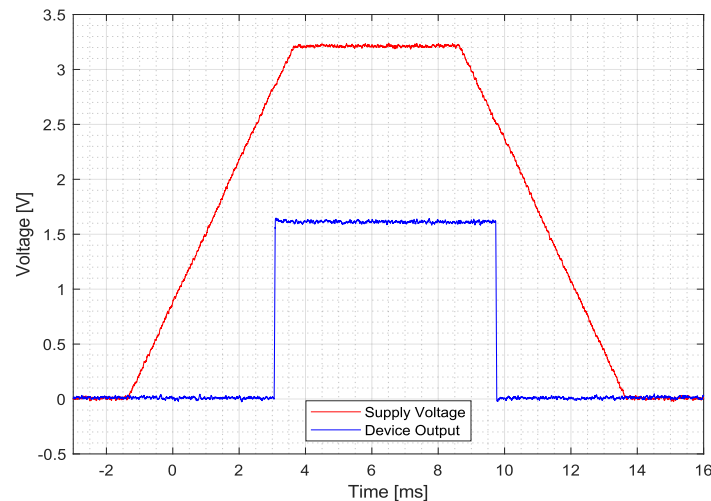

DEFINITIONS OF ACCURACY CHARACTERISTICS

Sensitivity (Sens). The change in sensor IC output in response to a 1 A change through the primary conductor. The sensitivity is the product of the magnetic circuit sensitivity (G/A) (1 G = 0.1 mT) and the linear IC amplifier gain (mV/G). The linear IC amplifier gain is programmed at the factory to optimize the sensitivity (mV/A) for the full-scale current of the device.

Nonlinearity (E_{LIN}). The nonlinearity is a measure of how linear the output of the sensor IC is over the full current measurement range. The nonlinearity is calculated as:

$$E_{LIN} = \left\{ 1 - \left[\frac{V_{IOUT}(I_{PR(max)}) - V_{IOUT(Q)}}{2 \cdot V_{IOUT}(I_{PR(max)/2}) - V_{IOUT(Q)}} \right] \right\} \cdot 100(\%)$$

Zero-Current Output Voltage (V_{IOUT(Q)}). The output of the sensor when the primary current is zero. For unipolar devices this value will be 10% of operating voltage, 0.5 V and 0.33 V for 5 V and 3.3 V respectively. For bidirectional devices, the output will be 50% of the operating voltage, 2.5 V and 1.65 V for 5 V and 3.3 V devices respectively. Since the ACS71240 is a non-ratiometric part, these values will be stable over V_{CC} variations. Variation in V_{IOUT(Q)} can be attributed to the resolution of the Allegro linear IC quiescent voltage trim and thermal drift.

Offset Voltage (V_{OE}). The deviation of the device output from its ideal quiescent value due to nonmagnetic causes. To convert this voltage to amperes, divide by the device sensitivity, Sens.

Total Output Error (E_{TOT}). The difference between the current measurement from the sensor IC and the actual current (I_P), relative to the actual current. This is equivalent to the difference between the ideal output voltage and the actual output voltage, divided by the ideal sensitivity, relative to the current flowing through the primary conduction path:

$$E_{TOT}(I_P) = \frac{V_{IOUT_ideal}(I_P) - V_{IOUT}(I_P)}{Sens_{ideal}(I_P) \cdot I_P} \cdot 100(\%)$$

The Total Output Error incorporates all sources of error and is a function of I_P. At relatively high currents, E_{TOT} will be mostly due to sensitivity error, and at relatively low currents, E_{TOT} will be mostly due to Offset Voltage (V_{OE}). In fact, at I_P = 0, E_{TOT} approaches infinity due to the offset. This is illustrated in Figure 2 and Figure 3. Figure 2 shows a distribution of output voltages versus I_P at 25°C and across temperature. Figure 3 shows the corresponding E_{TOT} versus I_P.

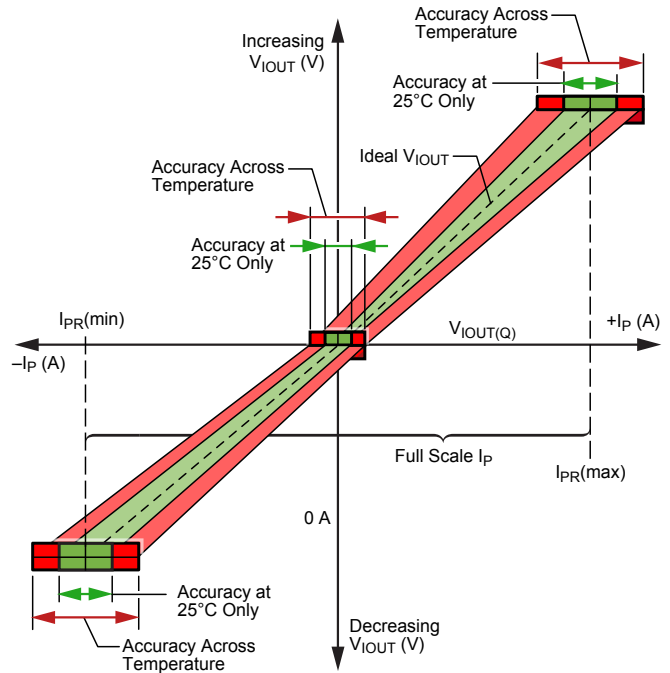

Figure 2: Output Voltage versus Sensed Current

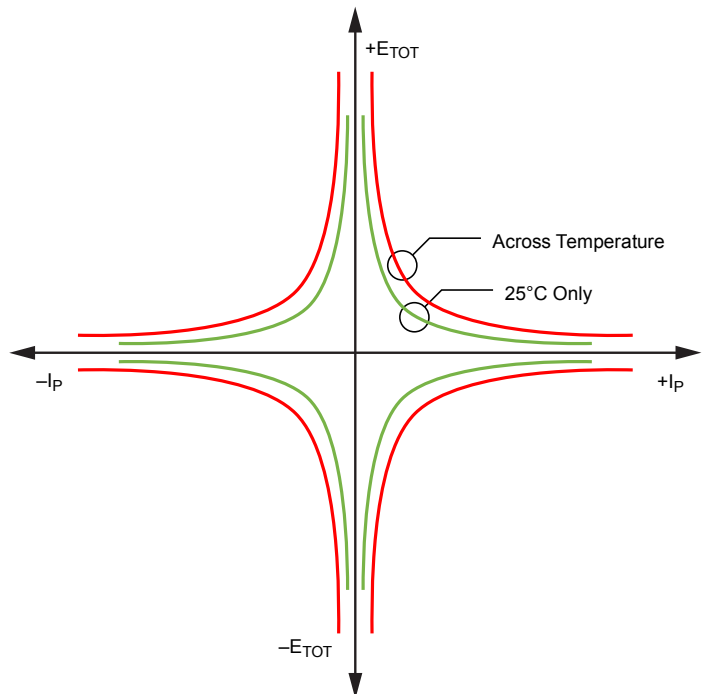

Figure 3: Total Output Error versus Sensed Current

Power Supply Rejection Ratio (PSRR). The ratio of the change on V_{IOUT} to a change in V_{CC} in dB.

$$PSRR = 20 \log_{10} \left(\left| \frac{\Delta V_{CC}}{\Delta V_{IOUT}} \right| \right)$$

FAULT Error (E_F). The difference between the current at which the FAULT pin trips (I_{FAULT}), relative to the ideal fault current (I_{FAULT_ideal}). This is equivalent to the difference between the ideal fault current and the actual fault current divided by the ideal current, and is defined as:

$$E_F = \frac{I_{FAULT} - I_{FAULT_ideal}}{I_{FAULT_ideal}} \times 100 (\%)$$

Fault Behavior

The ACS71240 is available with both a latched and unlatched $\overline{\text{FAULT}}$ pin output. Unless otherwise stated, the default operation is unlatched.

Unlatched Fault Behavior

In the event that the $\overline{\text{FAULT}}$ pin is unlatched, the $\overline{\text{FAULT}}$ output will only assert while an overcurrent condition is present. When an overcurrent condition occurs, the $\overline{\text{FAULT}}$ pin will be pulled low within $\overline{\text{FAULT}}$ response time, $t_{\overline{\text{FAULT}}}$. When the overcurrent condition is removed and $I_{\overline{\text{FAULT}}}$ falls below the overcurrent trip point minus the hysteresis ($I_{\text{F(HYS)}}$), another $t_{\overline{\text{FAULT}}}$ will delay the release of the line, after which the $\overline{\text{FAULT}}$ line will return to V_{CC} with a time constant based on the pull-up resistor and line capacitance (refer to Figure 4).

Latched Fault Behavior

In the event that the fault pin is latched, the $\overline{\text{FAULT}}$ output will assert when an overcurrent condition is present. The $\overline{\text{FAULT}}$ pin will remain latched even after the overcurrent condition has subsided. The $\overline{\text{FAULT}}$ pin will remain asserted until the device is power-cycled.

Fault Filtering

To prevent nuisance tripping while in latched mode, the ACS71240 is available with a variety of minimum fault times, which are the minimum period a fault event must be present before the $\overline{\text{FAULT}}$ pin will latch. This minimum period, t_{MASK} , can be 0 μs , 0.5 μs , or 1 μs ; the default t_{MASK} is 0 μs .

In latched mode, there is an additional delay of 1 clock cycle ($t_{\text{CLK}} < 150 \text{ ns}$) after the overcurrent event occurs. The fault behavior for latched and unlatched modes are shown in Figure 5 and Figure 6.

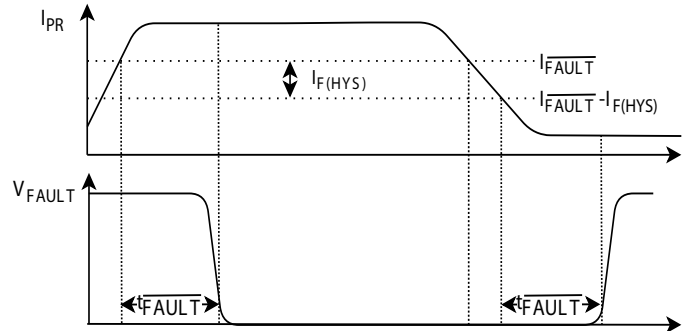

Figure 4: Fault trip with $\overline{\text{FAULT}}$ response time

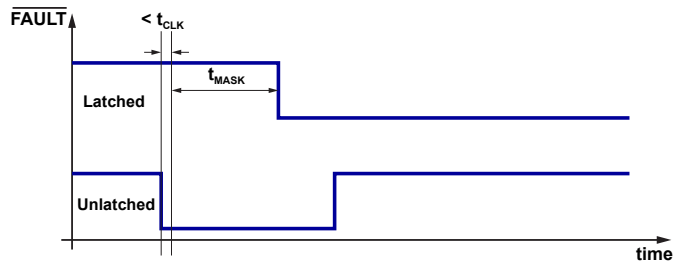

Figure 5: Fault event longer than t_{MASK}

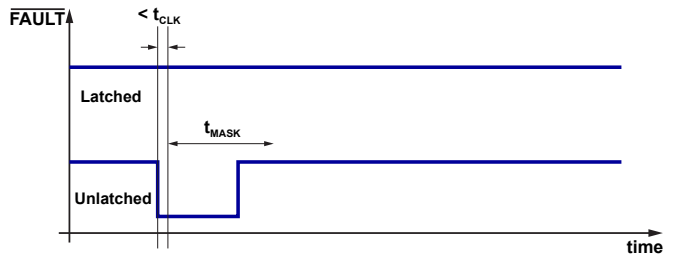

Figure 6: Fault event shorter than t_{MASK}

APPLICATION INFORMATION

Thermal Rise vs. Primary Current

Self-heating due to the flow of current should be considered during the design of any current sensing system. The sensor, printed circuit board (PCB), and contacts to the PCB will generate heat as current moves through the system.

The thermal response is highly dependent on PCB layout, copper thickness, cooling techniques, and the profile of the injected current. The current profile includes peak current, current “on-time”, and duty cycle. While the data presented in this section was collected with direct current (DC), these numbers may be used to approximate thermal response for both AC signals and current pulses.

The plots in Figure 7 and Figure 9 show the measured rise in steady-state die temperature of the ACS71240 in the LC package and EX package, respectively, versus continuous current at an ambient temperature, T_A , of 25 °C. The thermal offset curves may be directly applied to other values of T_A . Figure 8 and Figure 10 show the maximum continuous current at a given T_A . Surges beyond the maximum current listed in Figure 8 and Figure 10 are allowed given the maximum junction temperature, $T_{J(MAX)}$ (165°C), is not exceeded.

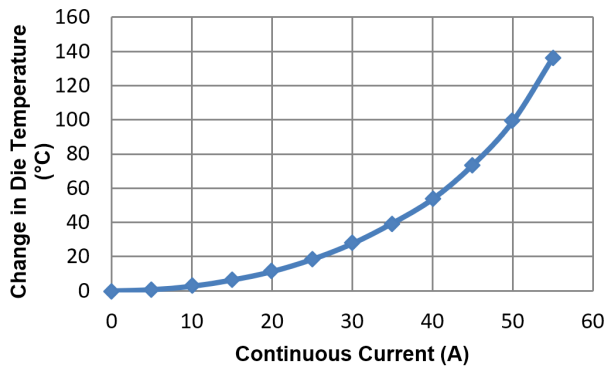

Figure 7: Self Heating in the LC Package Due to Current Flow

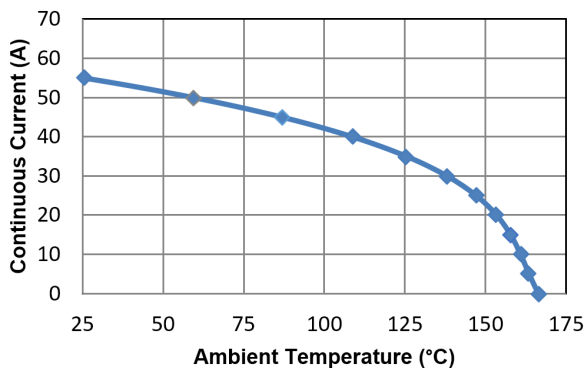

Figure 8: Maximum Continuous Current in the LC package at a Given T_A

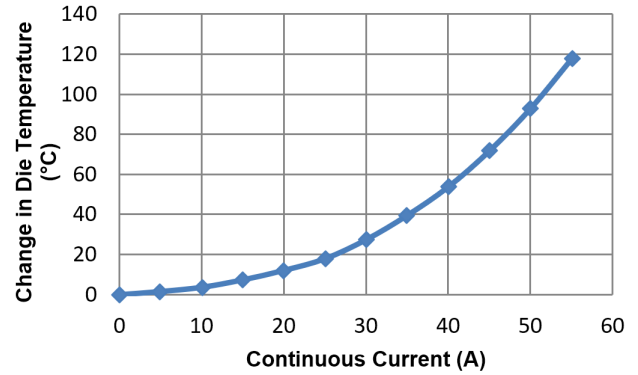

Figure 9: Self Heating in the EX Package Due to Current Flow

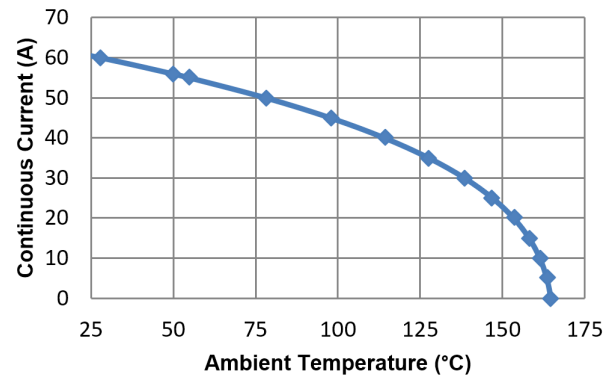

Figure 10: Maximum Continuous Current in the EX package at a Given T_A

The thermal capacity of the ACS71240 should be verified by the end user in the application’s specific conditions. The maximum junction temperature, $T_{J(MAX)}$ (165°C), should not be exceeded. Further information on this application testing is available in the [DC and Transient Current Capability application note](#) on the Allegro website.

ASEK71240 Evaluation Board Layout

Thermal data shown in Figure 7 and Figure 8 was collected using the ASEK71240 Evaluation Board (TED-0002524). This board includes 1500 mm² of 4 oz. copper (0.1388 mm) connected to pins 1 and 2, and to pins 3 and 4, with thermal vias connecting the layers. Top and bottom layers of the PCB are shown in Figure 11.

Thermal data shown in Figure 9 and Figure 10 was collected using the ASEK71240 Evaluation Board (TED-0002302). This board includes 250 mm² of 2 oz. copper (0.0694 mm) connected to pins 1 and 2, and to pins 3 and 4, with thermal vias connecting the layers. Top and bottom layers of the PCB are shown in Figure 12.

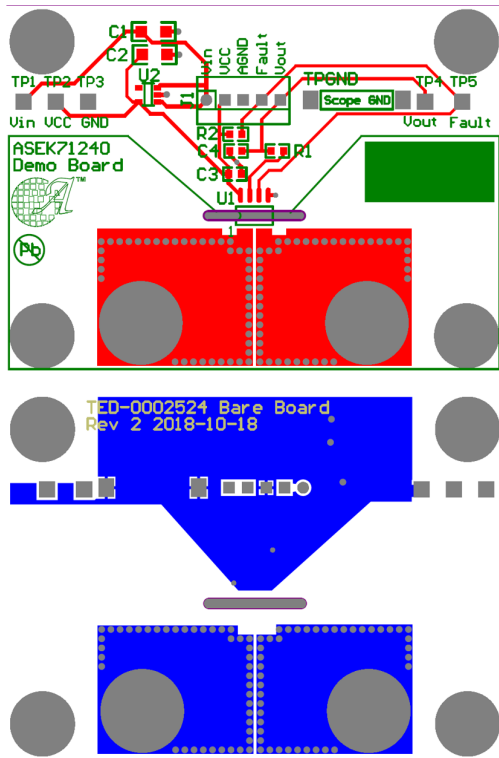

Figure 11: Top and Bottom Layers for ASEK71240 Evaluation Board (TED-0002524)

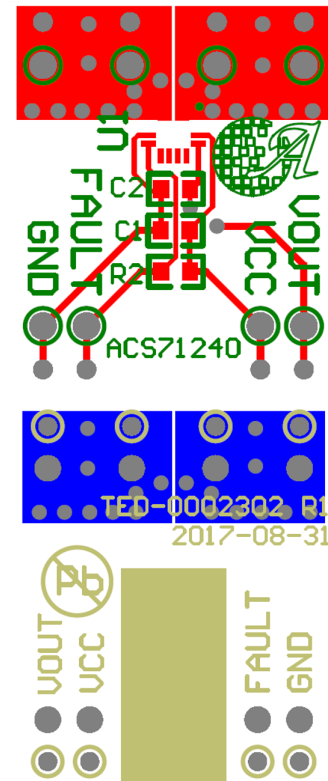

Figure 12: Top and Bottom Layers for ASEK71240 Evaluation Board (TED-0002302)

Gerber files for the ASEK71240 evaluation board are available for download from our website. See the technical documents section of the [ACS71240 device webpage](#).

Common-Mode Field Rejection

The ACS71240 features two Hall-effect sensors used differentially in order to eliminate stray field. The two sensors are placed on opposite sides of the current loop. This allows the common magnetic field to be determined and removed before the signal is sent to the end user. Despite this common field rejection, it is always best practice to reduce the amount of stray fields around the current sensor as much as possible. See the Allegro Applications note on reducing common mode field for more details.

PACKAGE OUTLINE DRAWINGS

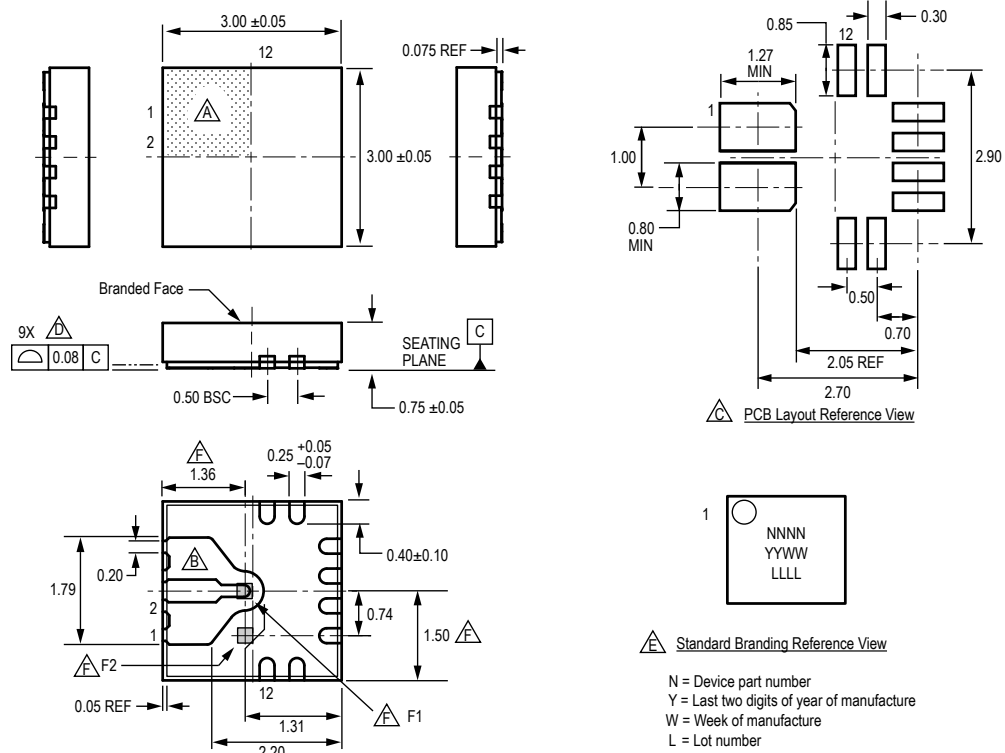

For reference only, not for tooling use (reference JEDEC MO-220WEED except for fused current path and wettable flank)
Dimensions in millimeters

Exact case and lead configuration at supplier discretion within limits shown

- △ Terminal #1 mark area
- △ Fused sensed current path
- △ Coplanarity includes exposed current path and terminals
- △ Branding scale and appearance at supplier discretion
- △ Reference land pattern layout (reference IPC7351 QFN50P300X300X80-17W4M); All pads a minimum of 0.20 mm from all adjacent pads; adjust as necessary to meet application process requirements and PCB layout tolerances; when mounting on a multilayer PCB, thermal vias at the exposed thermal pad land can improve thermal dissipation (reference EIA/JEDEC Standard JESD51-5)
- △ Hall elements (F1 and F2); not to scale

Figure 13: Package EXB, 12-Contact QFN with Fused Sensed Current Loop and Wettable Flank

For Reference Only – Not for Tooling Use

(Reference MS-012AA)

Dimensions in millimeters – NOT TO SCALE

Dimensions exclusive of mold flash, gate burrs, and dambar protrusions
Exact case and lead configuration at supplier discretion within limits shown

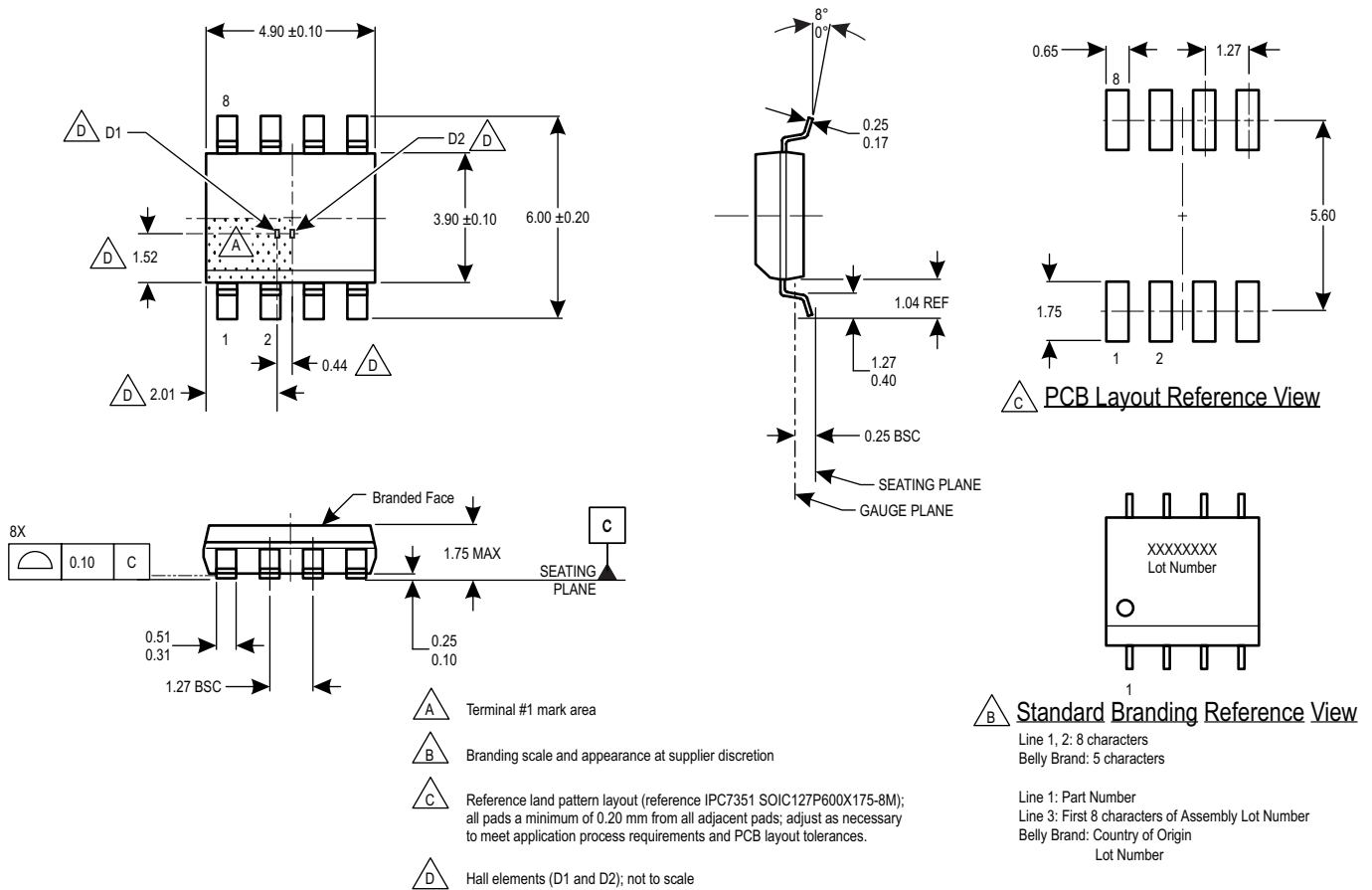

Figure 14: Package LCB, 8-Pin SOIC

Revision History

Number	Date	Description
–	March 7, 2019	Initial release
1	May 31, 2019	Updated TUV certificate mark
2	July 24, 2019	Added Hall elements to LC package drawing (page 20)
3	August 21, 2019	Added Maximum Continuous Current to Absolute Maximum Ratings table (page 2), ESD ratings table (page 2), and thermal data section (pages 17-18)
4	October 4, 2019	Added Comparative Tracking Index to Isolation Characteristics table (page 3), and Characteristic Performance Data charts (pages 13-15)
5	December 6, 2019	Added -030B5 part variant (pages 2, 10), Output Slew Rate characteristic (page 6), Typical Frequency Response note (page 16)
6	December 19, 2019	Added -030B3-167L part variant; updated Rise Time, Response Time, Propagation Delay, and Output Slew Rate test conditions, and Output Slew Rate value.
7	April 20, 2020	Added Primary Conductor Inductance values (page 6); removed FAULT Operating Point from Common Electrical Characteristics table (page 7); added FAULT Operating Point to Performance Characteristics tables (pages 8-13); updated Frequency Response (page 14); added Response Characteristics Definitions and Performance Data application page (page 15); added Power on Functional Description and Performance Data application page (page 16)
8	March 18, 2021	Added KEX-10B5 part variant (pages 2, 10); added KEX-020B5 and KEX-020B5-150L part variants (pages 2, 11); added KEX-045B5 variant (pages 2, 13); added KEX-050B5 part variant (pages 2, 14); added LLC-025B3 variant (pages 2, 16); added LLC-050B3 (pages 2, 17); added LLC-20U5 part variant (pages 2, 18); added LLC-050B5 part variant (pages 2, 19); updated ESD Ratings table Test Conditions (page 3); added extended sensing range equation to footnote [3] of the Common Electrical Characteristics table (page 7); added footnote [4] to FAULT Current Hysteresis in the Common Electrical Characteristics table (page 7); updated Fault Behavior application section (page 26)
9	April 23, 2021	Added KEX-50B3 part variant (pages 2, 10)
10	June 29, 2021	Added KEX-50B3-120 part variant (pages 2, 10)
11	July 27, 2021	Added -S lead free part variants (all pages)

Copyright 2021, Allegro MicroSystems.

Allegro MicroSystems reserves the right to make, from time to time, such departures from the detail specifications as may be required to permit improvements in the performance, reliability, or manufacturability of its products. Before placing an order, the user is cautioned to verify that the information being relied upon is current.

Allegro's products are not to be used in any devices or systems, including but not limited to life support devices or systems, in which a failure of Allegro's product can reasonably be expected to cause bodily harm.

The information included herein is believed to be accurate and reliable. However, Allegro MicroSystems assumes no responsibility for its use; nor for any infringement of patents or other rights of third parties which may result from its use.

Copies of this document are considered uncontrolled documents.

For the latest version of this document, visit our website:

www.allegromicro.com