

**SHENZHEN ATTEN TECHNOLOGY CO., LTD.**

---

- Soldering iron • Soldering station • Hot air rework station
- Multi-function maintenance system
- Regulated DC power supply • Switching DC power supply
- Programmable power supply

# ATTEN

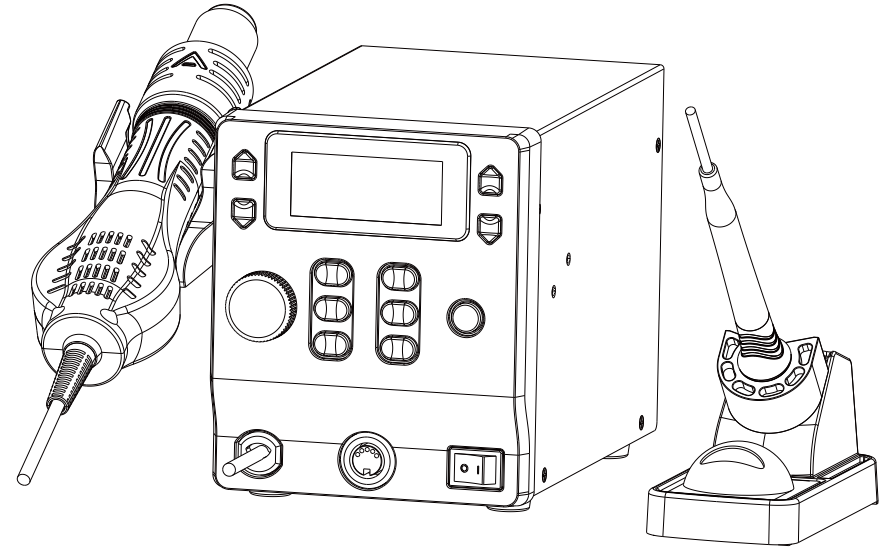

## ST-8802

# 2 in 1 Rework Station User Manual

The soldering iron needs to be tested before it leaves the factory, so the soldering tip may cover a small amount of tin, and the casing will be slightly yellowing, which is a normal phenomenon.

**SHENZHEN ATTEN TECHNOLOGY CO., LTD.**

Add: Floor 8, Building 2, Senyang High-tech Park, 7 West Road  
High-tech Park, Guangming New district, Shenzhen 518132, China

Tel: +86-755-2697 6387

Fax: +86-755-8602 1337

Web: [www.atten.com.cn](http://www.atten.com.cn)(CN)

[www.atten.com](http://www.atten.com)(EN)

Email: [sales@atten.com.cn](mailto:sales@atten.com.cn)

**Engineer's partner**

All Copyright Reserved  
MADE IN CHINA

CBN033003(A)

SHENZHEN ATTEN TECHNOLOGY CO., LTD

## Maintenance

(diagram 2-13) Display S-E is a sensor fault, display H-E is a heater core fault.

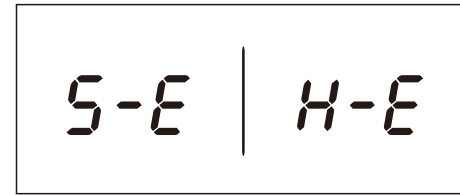

diagram 2-13

### Product warranty

- This product is guaranteed for two years from the date of purchase(excluding consumables such as the heating core). If any quality problem is found within the guarantee period, we will response for the maintenance free of charge.
- For those product beyond the warranty period, we provide life-long maintenance services.
- For those product damaged due to users' improper application and unauthorized changes to the product parts, our company only provides limited warranty service.
- In case of a product fault, please send the faulty product to the designated maintenance shop for maintenance, and those service center and personnel unauthorized by the factory are prohibited from carrying out any maintenance on the product.

### After-sales contact

After-sales service department Tel: (+86) 755-26976387

Product warranty card	Product Certification
<p>This product is guaranteed for two years from the date of purchase. If any quality problem is found within the guarantee period, we will response for the maintenance free of charge on presentation of this card and the receipt. We will repair and return the repaired equipment to the customer within 2 working days of the receipt date.</p> <p>Note: This warranty card must be attached when this product is returned to the factory for maintenance, otherwise free maintenance will not be accepted. Thank you for your cooperation!</p>	<p>Product Model: _____ Product No.: _____</p> <p>Inspector: _____ Ex-factory date: _____</p> <p>Salesperson: _____ Sold Date: _____</p>

## 6. Password setting function

Under the PSD menu , press left “▲” and “▼” to adjust the password setting value , the password value can be set from “01” to “999” .diagram 2-9 display the password function is off. diagram 2-10 display enter into the menu interface . should enter password and press “2” button to confirm to enter into menu if you already set password .The password function of the hot air gun and the soldering iron would be set simultaneously.  
(Note: Directly enter password 906 to enter the menu interface in case of forgetting the password.)

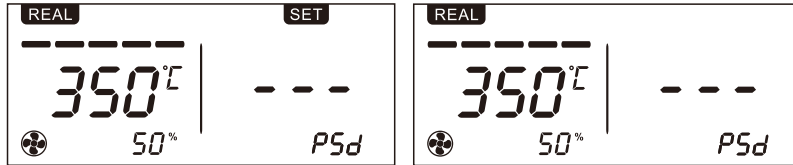

diagram 2-9

diagram 2-10

## 7. Button Beeping Function

Under menu BL mode, user can turn on/ off the beeping function by pressing right “▲” or “▼” key. diagram 2-11, ON enables beeping function; OFF disable beeping function. The beep alarm function of the hot air gun and the soldering iron would be set simultaneously.

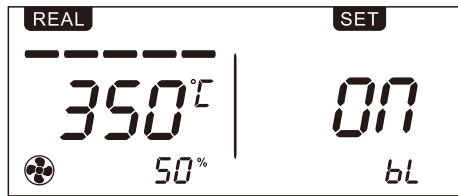

diagram 2-11

## 8. Restore Factory Setting

In FAC menu ,press right “▲” and “▼” keys to adjust ON/OFF. Press the [2] key when the menu is ON, then return to the normal operation interface to restore factory setting.The restore factory setting function of the hot air gun and the soldering iron would be set simultaneously.

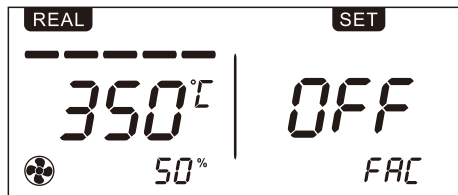

diagram 2-12

Default value :

SLP ( Auto sleep ) :10	Memory temperature 1 : 200°C
Loc ( temperature locked function ) : OFF	Memory temperature 2 : 300°C
CAL ( calibration value ) : cleared	Memory temperature3 : 400°C
F-C(temperature unit) : °C	
PSD ( password ) : OFF	
BL ( Beeping function ) : ON	

## Copyright information

The design of this product (including internal software) and its accessories is under the protection of relevant state-laws.Any violation of the relevant rights of our company will be subject to legal sanctions. Users shall consciously abide by the relevant state laws when using this product.

## Description of common icons

Thank you for using our products. Before using the product, please read this manual carefully and pay attention to the relevant warnings and cautions mentioned in this manual.

Warning	Misuse of this product may lead to serious injury or death to the user.
Caution	Misuse of this product may lead to serious injury to the user or material damage to the object involved.

## Essential knowledge for users

Users are required to have basic knowledge of common sense and electrical operations before using the product. Minors shall use the product under the guidance of a professional or guardian.

[Caution]:To avoid damaging the equipment and keep the safety of the operational environment,please read this manual carefully and keep it well so that you may read it at anytime when necessary.

## Safety precautions

To avoid electric shock or injury to the human body or fire hazard,the following basic rules must be observed when using the equipment.In order to ensure personal safety,only parts and accessories approved or recommended by the original factory can be used,otherwise serious consequences may occur!

WARNING
<p>When using this product, the soldering pencil/soldering tip, with the temperature up to 200-480 °C , may cause burns to the user or cause a fire due to improper application.</p> <p>So Users shall strictly observe the following rules:</p> <ul style="list-style-type: none"> <li>● Keep this product away from flammable materials.</li> <li>● Keep the product out of children's reach.</li> <li>● Do not use this product if you are inexperienced or have no sufficient necessary knowledge without the guidance of related personnel.</li> <li>● Do not use this product under wet environment or with wet hands to avoid electric shock.</li> <li>● Do not modify this product and its accessories without authorization.</li> <li>● Please turn off the power when replacing parts and iron tips, and not resume the use until the equipment is completely cooled down.</li> <li>● Please use the accessories from the original factory When replacing the product parts.</li> <li>● Make sure to turn off the power switch when the equipment is temporarily stopped or out of use.</li> </ul>

WARNING
<ul style="list-style-type: none"> <li>● To ensure the normal operation of this product's ESD function,only three-core power cord shall be used as the host connectingline.</li> <li>● Smoke will be generated during the soldering operations. So please pay attention to the smoke evacuation.</li> <li>● Do not play or do other similar dangerous actions during using this equipment, because it can easily lead to injury to others or yourself.</li> <li>● Do not use this product for purposes other than soldering.</li> <li>● Do not modify this product and accessories, otherwise the original warranty will be invalidated or damage may occur to the product.</li> <li>● When plugging and unplugging the power cord and handle plug, please hold the plug body and do not pull the cord.</li> <li>● Do not hit the product or its accessories too hard during the operation, otherwise damage may occur to the product.</li> </ul>

## Disclaimer

We will take no responsibility for any personal injury or property damage caused by reasons other than the product quality problem, which may include force majeure (natural disasters,etc.) or personal behavior during the operation of this product. This manual is organized, compiled and released by SHENZHEN ATTEN TECHNOLOGY CO.,LTD. according to the latest product features. We will not responsible for further notice of the subsequent improvement of the product and this Manual.

## Schematic Diagram of the Whole Equipment

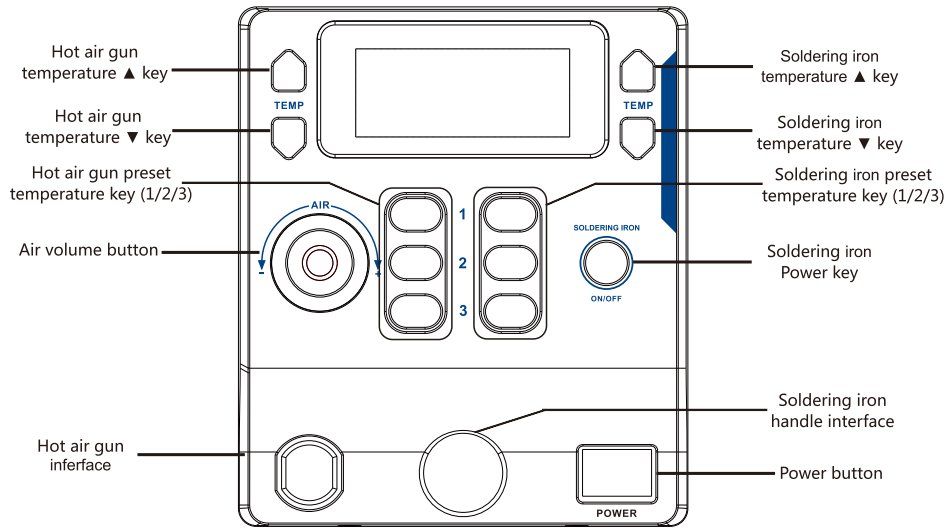

## Connection Diagram for the Whole Equipment

### Packing list:

- Main host x 1
- Hot air gun holder x 1
- Spray nozzles x 4
- Soldering handle x 1
- Iron stand x 1
- Power cord x 1
- Manual x 1

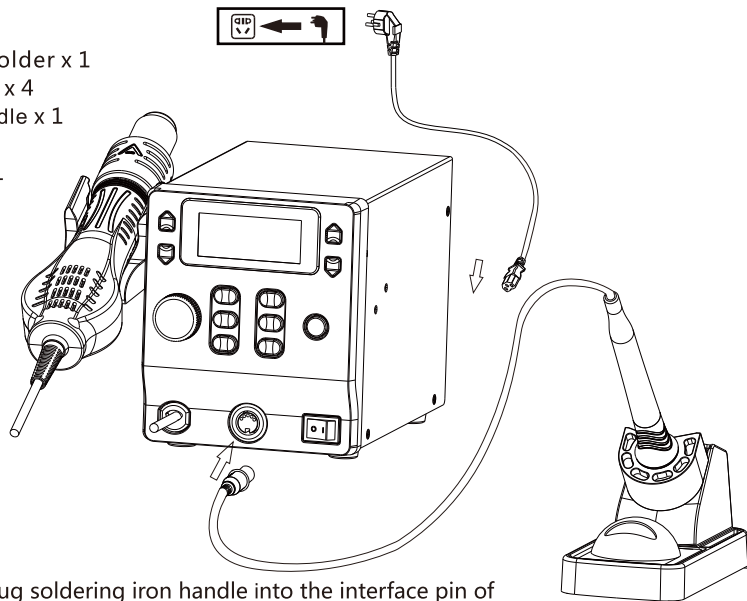

## 3. Temperature Locking Function

Under Menu Loc, it can turn on or turn off temperature locking function by pressing right "▲" or "▼" key (diagram. 2-6, ON means turn on temperature lock function, OFF means turn off temperature locking function); it can turn up or down menu by pressing Button "1" or "3", then press Button "2" to exit and save your setting.

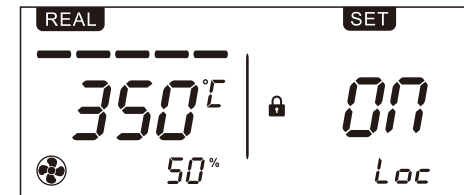

diagram 2-6

## 4. Temperature Calibration

Under menu CAL mode, press right "▲" or "▼" key to enable temperature calibration function, whose calibration range is -50°C~ 50°C (-90°F~90°F). Calibration value will be negative as actual-measured temperature is lower than setting temperature; Calibration value will be positive as actual-measured temperature is higher than setting temperature.

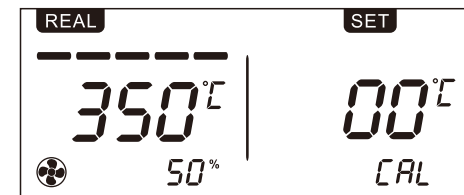

diagram 2-7

Note: User need calibrate temperature by adjusting its value if the displayed temperature is much different with actual-measured temperature after changing a new heater or tips, its calibration method be referred as below:  
1. Set this handle required calibration as a suitable temperature like 350°C/ 662°F;  
2. After this setting temperature is stable, use temperature tester to measure the actual temperature of its tip, for example, its actual-measured temperature is 365°C/ 689°F;  
3. We can get conclusion that the actual-measured temperature compared to the setting temperature is 15°C/ 27°F higher;  
4. Then press "▲" key to calibrate temperature.

## 5. Switching Temperature Unit

Under menu C-F mode, it can switch temperature units (°C&°F) by pressing right "▲" or "▼" key (diagram. 2-8, set -C- which means temperature unit is °C; set -F- which means temperature unit is °F; (The temperature unit of the hot air gun and the soldering iron would be switched simultaneously.)

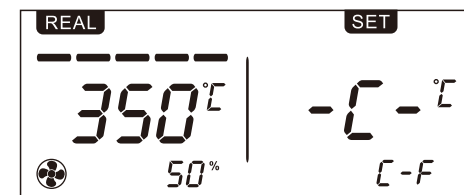
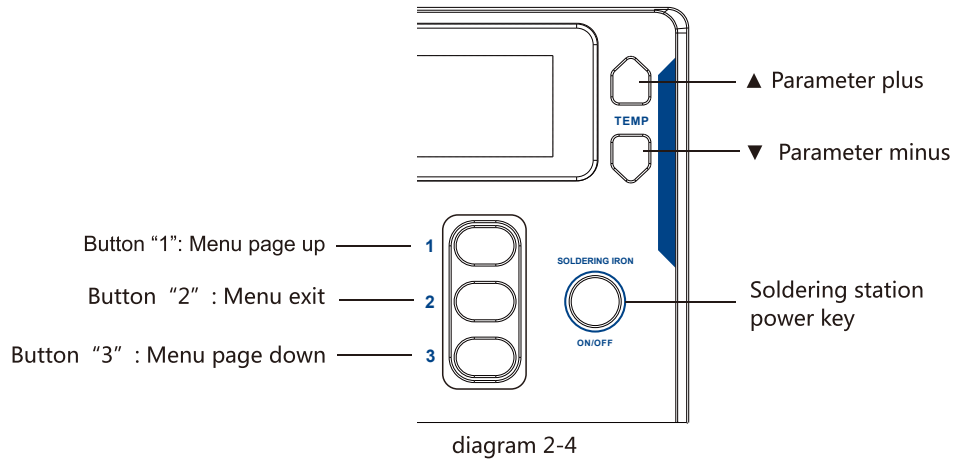

diagram 2-8

## Menu Mode

Under normal work, press right "1"+"3" button more than 3 seconds to enter the password input interface. No password for the first time . press 2 button to enter the menu mode , then input password to enter. Press the 2 button on the menu to exit and save the settings. (Note:After all the functions are set , press 2 to save the settings)

### 1.Button Definition under Menu Setting Mode.



### 2. Auto-sleep function

Under the SLP menu, press right "▲" and "▼" to set the sleep parameters:Off/On Time:10~60 (default 10) minutes. the heater temperature is 200 °C under sleep status. (diagram 1-14) open the auto sleep function, and the sleep time is 20 minutes. (display OFF) turn off the auto sleep function . In sleep mode, pick up the soldering tool or press any key to automatically resume normal operation. (Note: If the device is not in a static state, it will affect the device to enter auto sleep)

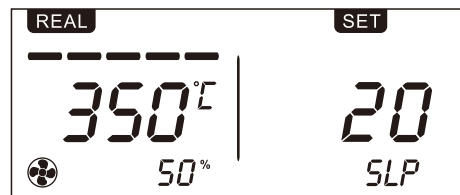

## Technical Data

Model:	ST-8802	
Type	Soldering station	Hot air station
Voltage	AC 230V ± 10% 50Hz ( 110V ± 10% 60Hz )	
Fuse type	T5A(230VAC) T10A(110VAC)	
Power	65W	800W
Temperature range	80°C~480°C/176°F~896°F	100°C~500°C/212°F~932°F
Temperature stability	±2°C	±5°C
Air volume adjustment		Knob
Temperature adjustment	10 digits (coarse) 1 digit (fine-tuning)	
Standby mode	Adjustable from 0-60mins	Enter into sleep mode automatically when putting this hot air gun on the holder
Turn off heating function	Turn off heating function	Heating closed after entering into sleeping mode for 10mins
Quick function	3 sets shortcut temperatures	
Working conditions	Temperature 0-40°C, relative humidity <80%	
Storage conditions	Temperature -20-80°C, relative humidity <80%	
Dimension	(L)210x(W)125x(H)150mm	
Weight	3.7KG	

## LCD Description

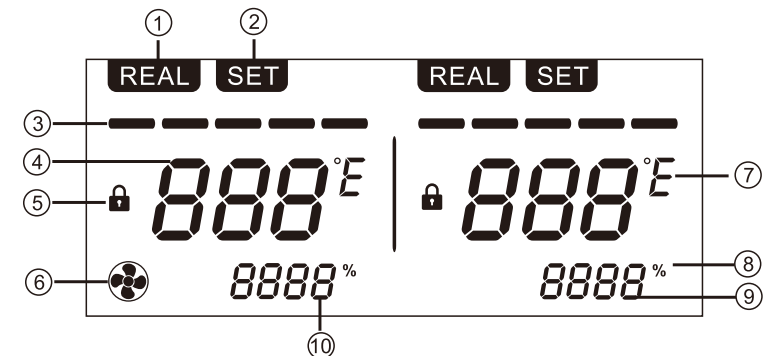

Hot air station displayed by the left side, soldering station displayed by the right side.

- |  |                             |
|--|-----------------------------|
| 1. REAL : Real Temperature status            | 6. Fan icon                 |
| 2. SET : Start up and set temperature status | 7. Temperature unit         |
| 3. Display bar for heating power status      | 8. Air flow percentage      |
| 4. Actual temperature value                  | 9. Preset temperature value |
| 5. Symbol for lock                           | 10. Air volume value        |

## Boot-up Screen

After the station has been switched on, the display will turn on and show the system version number for one second before switching to the normal display.  
( Its version will be different according with version updated, such as VXX, X etc. )



( Means V0.1 version )

## Working status

### 1. Work normally

Meaning on the right(diagram 1-1) : Real temperature is 350 °C, setting temperature value is 350 °C, this setting value locked, the display bar of heating power showing full.

Meaning on the left(diagram 1-1) : Real temperature is 350 °C, air volume is 50%, the display bar of heating power showing full.

### 2. Enter into standby mode

Meaning on the right (diagram 1-2) : Under standby status for soldering station, it is heating by 200 °C, soldering station can be recovered to normal work by pressing any buttons or swinging the handle.

Meaning on the left(diagram 1-2) : When hot air gun putting on the holder, the hot air gun enter into standby mode nether heating nor blowing air, and it will recover to normal work when taking this handle out.

### 3. Heating closed mode

Meaning on the right (diagram 1-3) : Under shut off status for soldering station, it is not heating, need press power button again if want to turn on soldering station.

Meaning on the left (diagram 1-3) : Under shut off status for hot air station, it can't work by holding the handle, it need recover to work by pressing power button in the side key of hot air station.

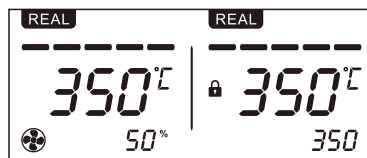

diagram 1-1

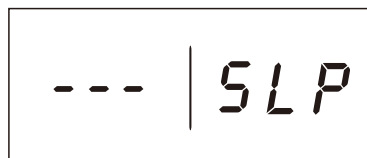

diagram 1-2



diagram 1-3

## How to operate soldering station

The right side is for soldering station operation area , left side is for hot air station operation area. Both of them work independently .

### Power on soldering station and the temperature setting

The screen will be displayed (diagram 2-1) after turning on the power key ,the soldering station are still closed , should turn on the soldering station power key to start soldering iron.Under working status press right "▲"or"▼"key (diagram 2-3) to adjust temperature (diagram 2-2) . Long press to adjust quickly ,stop to press key after 3 seconds to save temperature value automatically .  
(The temperature value cannot be adjusted when locked)

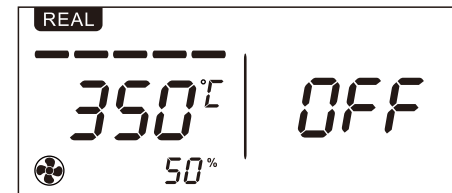

diagram 2-1

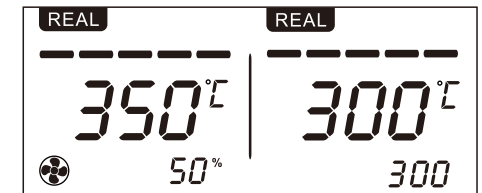

diagram 2-2

### Retrieving and Saving Shortcut Temperature(User define)

Under normal working status ,Retrieving shortcut temperature: It can rapidly retrieving preset temperature as current working emperature. by pressing right button "1"/"2"/"3". (diagram 2-3)

Under normal working status , Saving shortcut temperature : It can save the current working temperature into memory . by long pressing button "1"/ "2"/ "3" more than 3 seconds.

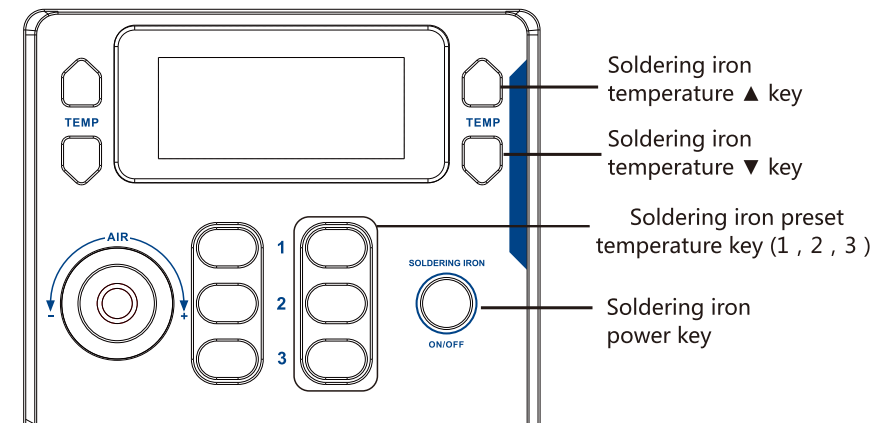

diagram 2-3

## 6. Password setting function

Under the PSD menu , press left “▲” and “▼” to adjust the password setting value , the password value can be set from “01” to “999” .diagram 1-13 display the password function is off. diagram 1-14 display enter into the menu interface . should enter password and press “2” button to confirm to enter into menu if you already set password .The password function of the hot air gun and the soldering iron would be set simultaneously.  
(Note: Directly enter password 906 to enter the menu interface in case of forgetting the password.)

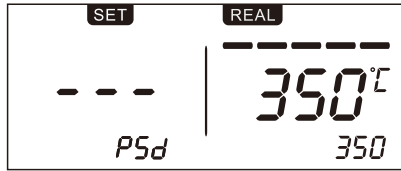

diagram 1-13

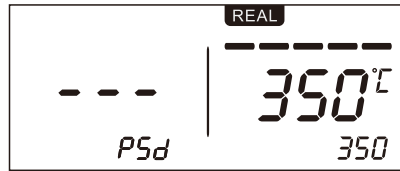

diagram 1-14

## 7. Button Beeping Function

Under menu BL mode, user can turn on/ off the beeping function by pressing right “▲” or “▼” key. diagram 1-15, ON enables beeping function; OFF disable beeping function. The beep alarm function of the hot air gun and the soldering iron would be set simultaneously.

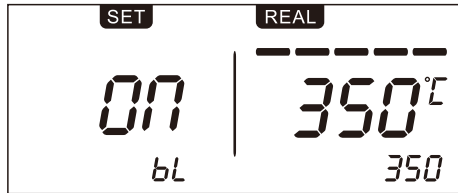

diagram 1-15

## 8. Restore Factory Setting

In FAC menu ,press left “▲” and “▼” keys to adjust ON/OFF. Press the [2] key when the menu is ON, then return to the normal operation interface to restore factory setting. The restore factory setting function of the hot air gun and the soldering iron would be set simultaneously.

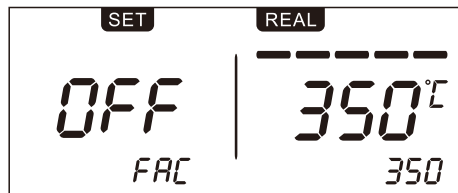

diagram 1-16

Default value :

HT ( Timing operation ) :OFF	Memory temperature 1 : C-L ( Cool air function )
Loc ( temperature locked function ) : OFF	Memory temperature 2 : 300°C/50% Air flow
CAL ( calibration value ) : Cleared	Memory temperature3 : 400°C/50% Air flow
F-C(temperature unit) : °C	
PSD(Passsword) : OFF	
BI ( Beeping function ) : ON	

## How to operate hot air station

The right side is for soldering station operation area , left side is for hot air station operation area. Both of them work independently .

### Temperature /Air flow setting

Its temperature can be adjustable by ▲/▼ key on the left when normal working (diagram 1-4), can be adjusted rapidly by pressing the key for long time, will auto-save this setting temperature without pressing for 3 seconds. Air volume can be adjusted by air volume knob, adjusting with clockwise means adding air volume, counterclockwise means reducing air volume.(Temperature and volume can't be adjusted if these parameters locked)

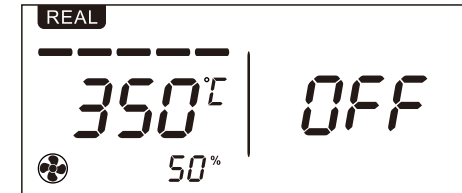

diagram 1-4

### Retrieving and Saving Shortcut Temperature(User define)

Preset temperature/ air volume can be retrieved rapidly by pressing left Button 1/2/3 when normal working (diagram 1-5).

Preset temperature/air volume can be saved when normal working, current setting temperature/air volume can be saved in button 1/2/3 by pressing button 1/2/3 longer than 3 seconds.

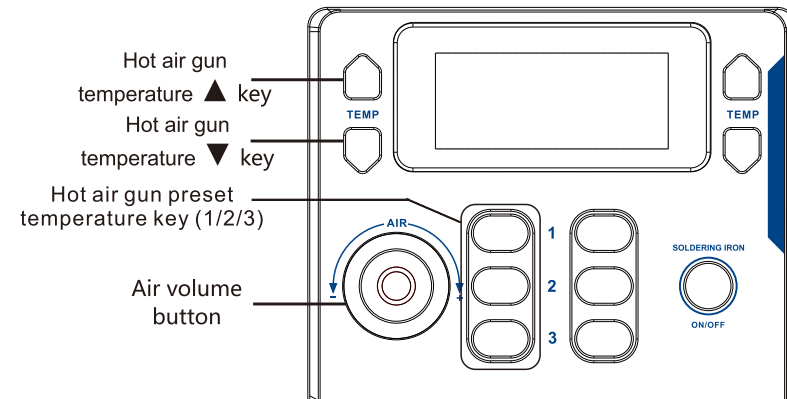

diagram 1-5



### Cool air function

The hot air gun enter into cool air mode when the setting temperature value under 100°C, shortcut key "1" defaults to cool air mode. Cool air mode display C-L (diagram 1-6) and heater element not heat, the air gun blows cool air then the heater quickly cool down.

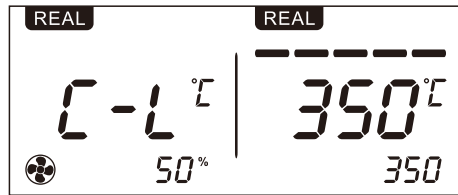

diagram 1-6

### Menu Mode

Under normal work, press left "1"+"3" button more than 3 seconds to enter the password input interface. No password for the first time . press 2 button to enter the menu mode , then input password to enter. Press the 2 button on the menu to exit and save the settings. (Note:After all the functions are set , press 2 to save the settings)

#### 1. Button Definition under Menu Setting Mode

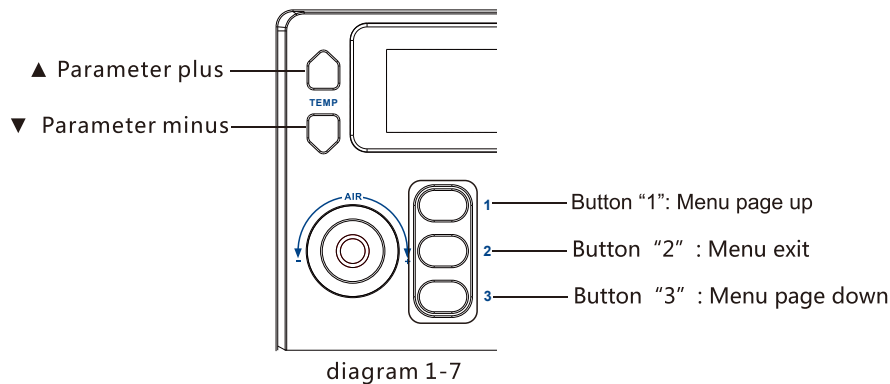

diagram 1-7

#### 2. Defining Work Function

Under the HT menu, press left "▲" and "▼" keys to adjust the timed working time. [1] [3] key to switch menu up or down, [2] key to exit and save setting values. display OFF to turn off timing function. The minimum setting time is 10 seconds and the maximum is 900 seconds. (Diagram 1-8) the timing work time is 900 seconds. (Note: the timing function is effective after hot air gun starting to work next time.)

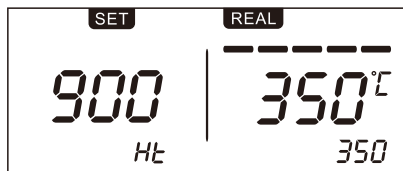

diagram 1-8

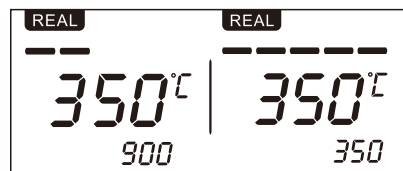

diagram 1-9

### 3. Temperature Locking Function

Under Menu Loc, it can turn on or turn off temperature locking function by pressing left "▲" or "▼" key (diagram. 1-10, ON means turn on temperature lock function, OFF means turn off temperature locking function); it can turn up or down menu by pressing Button "1" or "3" , then press Button "2" to exit and save your setting.

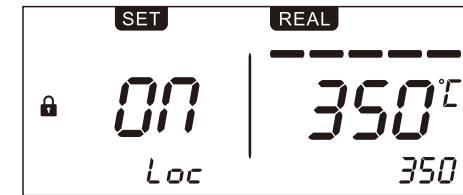

diagram 1-10

### 4. Temperature Calibration

Under menu CAL mode, press left "▲" or "▼" key to enable temperature calibration function, whose calibration range is -50°C~ 50°C(-90°F~90°F). Calibration value will be negative as actual-measured temperature is lower than setting temperature; Calibration value will be positive as actual-measured temperature is higher than setting temperature.

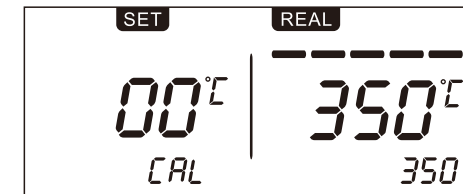

diagram 1-11

Note: User need calibrate temperature by adjusting its value if the displayed temperature is much different with actual-measured temperature after changing a new heater or tips, its calibration method be refered as below:  
 1. Set this handle required calibration as a suitable temperature like 350°C/ 662°F;  
 2. After this setting temperature is stable, use temperature tester to measure the actual temperature of its tip, for example, its actual-measured temperature is 365°C/ 689°F;  
 3. We can get conclusion that the actual-measured temperature compared to the setting temperature is 15°C/ 27°F higher;  
 4. Then press "▲" key to calibrate temperature.

### 5. Switching Temperature Unit

Under menu C-F mode, it can switch temperature units(°C&°F) by pressing left "▲" or "▼" key. diagram. 1-12, set -C- which means temperature unit is °C ; set -F- which means temperature unit is °F ; (The temperature unit of the hot air gun and the soldering iron would be switched simultaneously.)

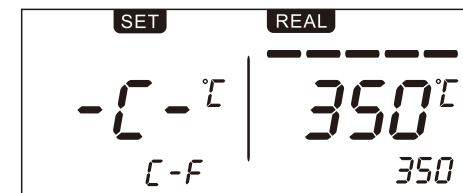

diagram 1-12