

REV.	DESCRIPTION	DRAWN	CHECKED	APPROVED
A	NEW RELEASE	YCH 03/16/09'	~	LJC 03/16/09'
B	DRAWING UPDATE	JLZ 05/18/17'	HZW 05/18/17'	LJC 05/18/17'
C	DRAWING UPDATE	JLZ 06/12/18'	~	

TERMINAL

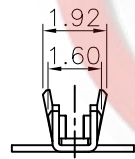
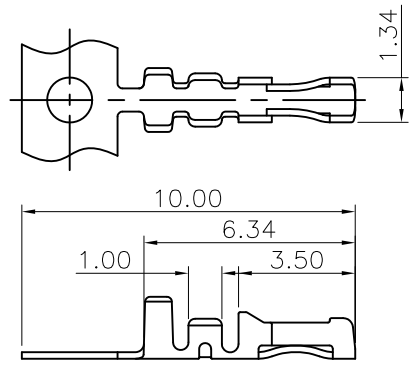

NOTES:

1. MAIN SPECIFICATIONS

- . Rated voltage: 250V
- . Rated current: 1A
- . Contact resistance:  $\leq 30m\Omega$
- . Insulation resistance:  $\geq 1000M\Omega$
- . Withstanding voltage: 500V,AC 1 minute
- . Temperature range: -25 ~ +85°C

2. PRODUCT NUMBER CODE:

Housing

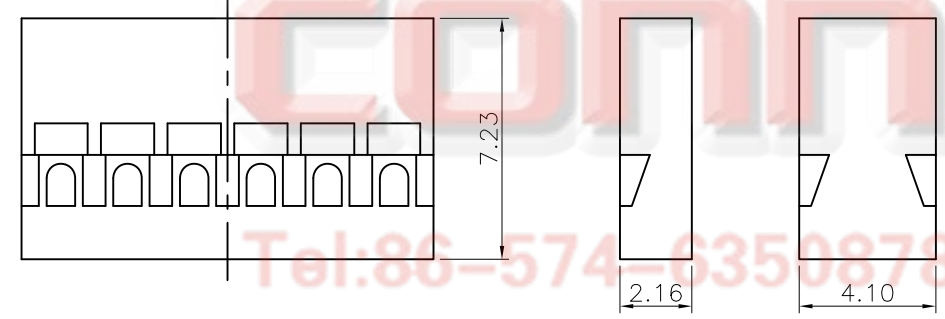

TERMINAL

T - DS1071-01 - S C X 0 0

- Contact Plating
- 0: Selective Gold Flash
- 6: Full Tin
- 8: Full Gold Flash

Housing

I - DS1071-01 - S C B 0 X

- No. of Hole
- 1\*1~1\*40(Single row)
- 2\*1~2\*40(Double row)
- Housing Color
- B: Black

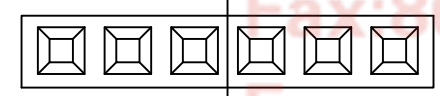

Single row Double row

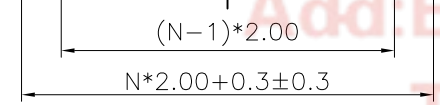
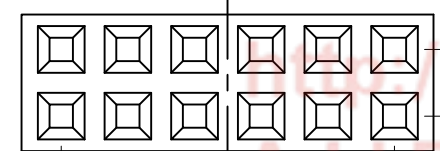

N=No. of Hole(Single row)  
N=No. of Hole/2(Double row)

GENERAL TOLERANCE		ANGLE TOLERANCE	
.X	±0.60	.X	±5°
.X	±0.38	.X	±3°
.XX	±0.25	.XX	±2°

PROJECTION	TITLE
UNITS	P.C.B CONNECTOR 2.00mm TJC8 TYPE
SHEET SIZE	SERIES DS1071-01 SERIES

DRAWING TYPE	CUSTOMER		
SCALE	1:1	SHEET	1 OF 1
DRAWING NO.	C-DS1071-01-XXXXX-C		

**晨翔电子有限公司**  
**CONNFLY CONNFLY ELECTRONIC CO. LTD**

Tel:86-574-63508787  
 Fax:86-574-63510817  
 E-mail:sale@connfly.com  
 http://www.connfly.com  
 Add:East Industry Zone KuangYan  
 Town Cixiang Ningbo  
 P.C:315333