



Disea Electronics Co., LTD

E-mail: sales@diseaelec.com URL: www.diseaelec.com
ADD: AI Building, Electronic Information Industry Park,
Keji 1st Road, Dinghu district, Zhaoqing city, Guangdong
Province, China

PRODUCT SPECIFICATIONS

For Customer: _____

: APPROVAL FOR SPECIFICATION

Customer Model No. _____

: APPROVAL FOR SAMPLE

Module No.: ZW-T043BPIA-01

Date : 2023-7-10

Table of Contents

No.	Item	Page
1	Cover Sheet(Table of Contents)	P1
2	Revision Record	P2
3	General Specifications	P3
4	Outline Drawing	P4
5	Absolute Maximum Ratings	P5
6	Electrical Specifications	P6-P13
7	Optical Characteristics	P14-P17
8	Reliability Test Items and Criteria	P18
9	Precautions for Use of LCD Modules	P19-P20

For Customer's Acceptance:

Approved By	Comment

PREPARED	CHECKED	VERIFIED BY QA DEPT	VERIFIED BY R&D DEPT
YZJ			

2. Revision Record

Date	Rev.No.	Page	Revision Items	Prepared
2023-7-10	V0		The first release	YZJ

3. General Specifications

ZW-T043BPIA-01 is a TFT-LCD module. It is composed of a TFT-LCD panel, driver IC, FPC, a back light unit . The 4.3'' display area contains 480 x (RGB) x 272 pixels and can display up to 16.7M colors. This product accords with ROHS environmental Criterion.

Item	Contents	Unit	Note
LCD Type	TFT	-	
Display color	16.7M	-	1
Viewing Direction	ALL	O'Clock	
Operating temperature	-30~+80	°C	
Storage temperature	-30~+80	°C	
Module size	Refer to outline drawing	mm	2
Active Area(W×H)	95.04X53.86	mm	
Number of Dots	480 x 272	dots	
Controller	ILI6485D	-	
Power Supply Voltage	3.3	V	
Backlight	5X2-LEDs	pcs	
Weight	---	g	
Interface	RGB888	-	

Note 1: Color tune is slightly changed by temperature and driving voltage.

Note 2: Without FPC and Solder .

4.Outline Drawing

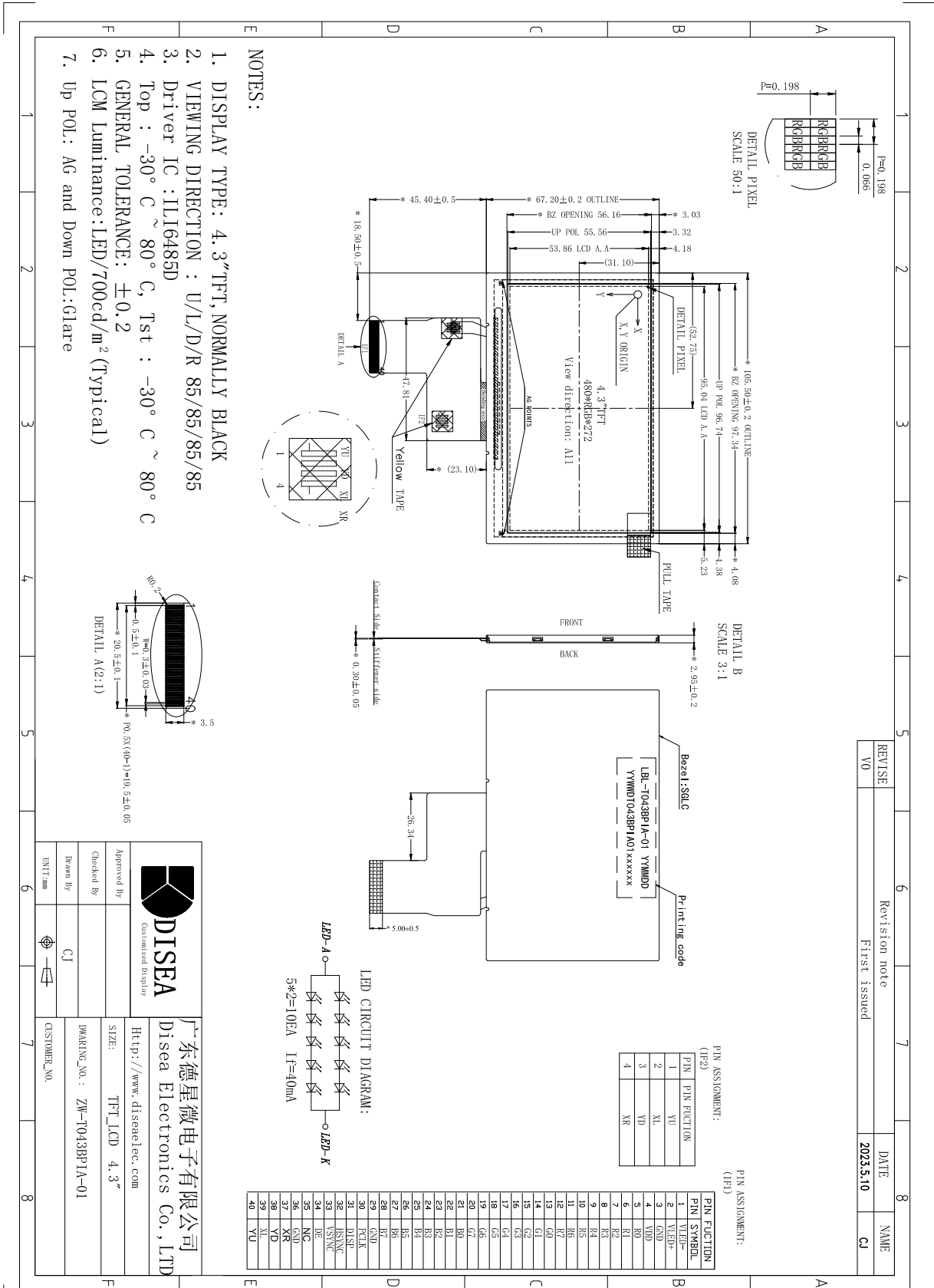

5. Absolute Maximum Ratings($T_a=25\text{ }^\circ\text{C}$)

5.1 Electrical Absolute Maximum Ratings.($V_{SS}=0V, T_a=25\text{ }^\circ\text{C}$)

Item	Symbol	Min.	Max.	Unit	Note
Power Supply Voltage	VDD	-0.3	4.6	V	1, 2

Notes:

1. If the module is above these absolute maximum ratings. It may become permanently damaged. Using the module within the following electrical characteristic conditions are also exceeded, the module will malfunction and cause poor reliability.
2. $V_{DD} > V_{SS}$ must be maintained.
3. Please be sure users are grounded when handing LCD Module.

5.2 Environmental Absolute Maximum Ratings.

Item	Storage		Operating		Note
	MIN.	MAX.	MIN.	MAX.	
Ambient Temperature	-30 $^\circ\text{C}$	80 $^\circ\text{C}$	-30 $^\circ\text{C}$	80 $^\circ\text{C}$	1,2
Humidity	-	-	-	-	3

Notes:

1. The response time will become lower when operated at low temperature.
2. Background color changes slightly depending on ambient temperature.
The phenomenon is reversible.
3. $T_a \leq 40\text{ }^\circ\text{C}$: 85%RH MAX.
 $T_a > 40\text{ }^\circ\text{C}$: Absolute humidity must be lower than the humidity of 85%RH at 40 $^\circ\text{C}$.

6. Electrical Specifications

6.1 Electrical characteristics ($V_{SS}=0V, T_a=25^\circ C$)

Parameter	Symbol	Condition	Min	Typ	Max	Unit	Note
Power supply	VDD	$T_a=25^\circ C$	3.0	3.3	3.6	V	
Input voltage	'H'	V_{IH}	$T_a=25^\circ C$	$0.7 \cdot VDD$	-	VDD	V
	'L'	V_{IL}	$T_a=25^\circ C$	0	-	$0.3 \cdot VDD$	V

6.2 LED backlight specification ($V_{SS}=0V, T_a=25^\circ C$)

Item	Symbol	Condition	Min	Typ	Max	Unit	Note
Supply voltage	V_f	$I_f=40mA$	14	15	16.5	V	
Uniformity	ΔB_p	$I_f=40mA$	75	80	-	%	
Life Time	time	$I_f=40mA$	-	30K	-	hours	1

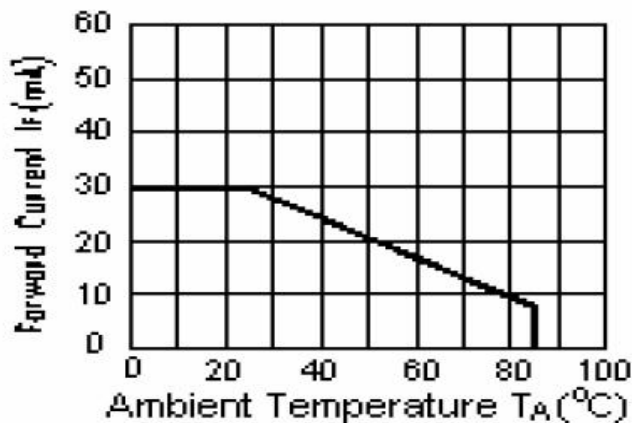

Note 1: Brightness to be decreased to 50% of the initial value at ambient temperature $T_A=25^\circ C$

6.3 Interface signals

Pin No.	Symbol	I/O	Function
1	VLED-	P	LED back light(Cathode).
2	VLED+	P	LED back light(Anode).
3	GND	P	Ground.
4	VDD	P	Power supply.
5-12	R0~R7	I	Red data bus.
13-20	G0~G7	I	Green data bus.
21-28	B0~B7	I	Blue data bus.
29	GND	P	Ground.
30	PCLK	I	Data clock.
31	DISP	I	Standby mode select pin
32	HSYNC	I	Line sync signal
33	VSYNC	I	Frame sync signal
34	DE	I	Data enable pin
35	NC	-	No connection.
36	GND	P	Ground.
37	XR	O	RTP control pin,no use please NC.
38	YD	O	
39	XL	O	
40	YU	O	

6.4 AC Characteristics

6.4.1 AC Characteristics

System Bus Timing for RGB Interface

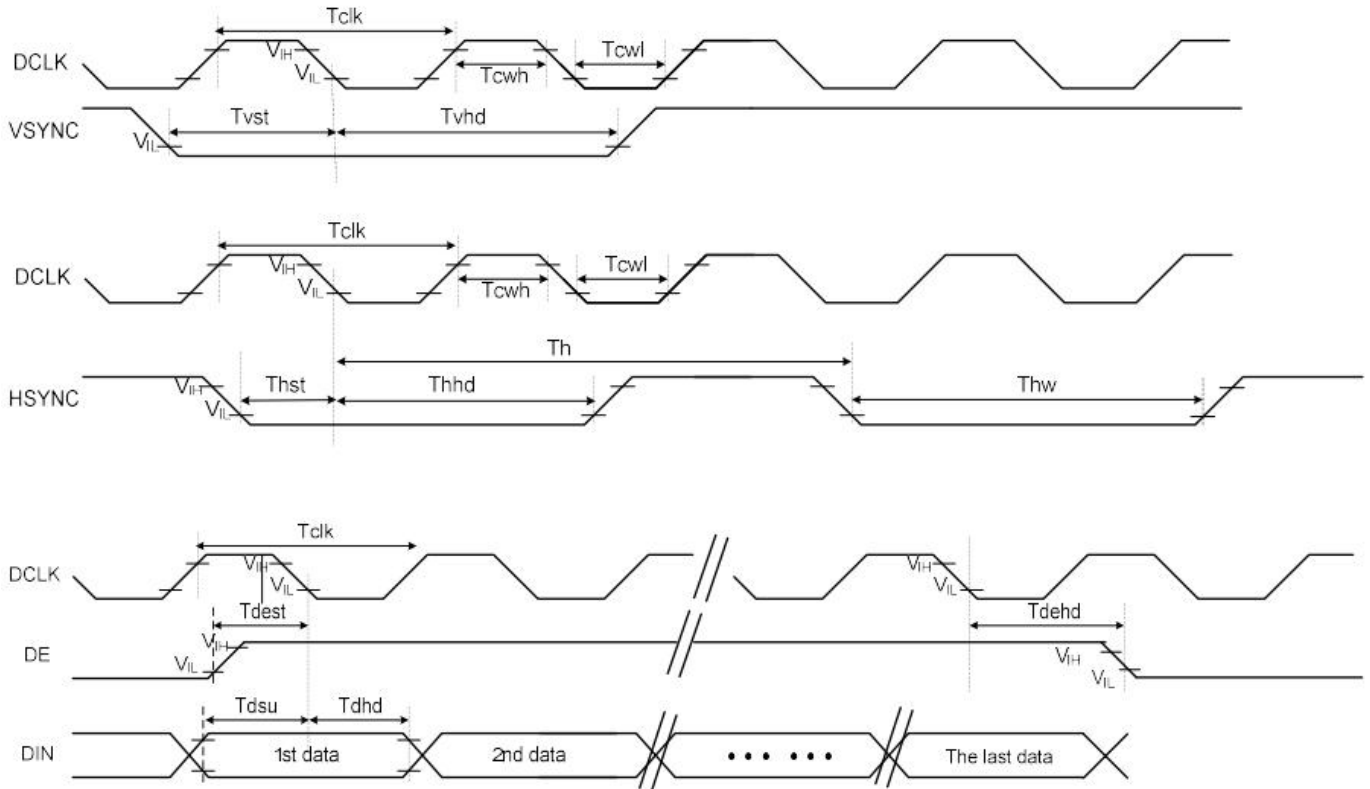

Item	Symbol	Min.	Typ.	Max.	Unit	Conditions
CLK Pulse Duty	Tcw	40	50	60	%	
HSYNC Width	Thw	2	-	-	DCLK	
HSYNC Period	Th	55	60	65	us	
VSYNC Setup Time	Tvst	12	-	-	ns	
VSYNC Hold Time	Tvhd	12	-	-	ns	
HSYNC Setup Time	Thst	12	-	-	ns	
HSYNC Hold Time	Thhd	12	-	-	ns	
Data Setup Time	Tdsu	12	-	-	ns	
Data Hold Time	Tdhd	12	-	-	ns	
DE Setup Time	Tdest	12	-	-	ns	
DE Hold Time	Tdehd	12	-	-	ns	

6.4.2 Parallel RGB Timing Table

480RGB X 272 Resolution Timing Table							
Item	Symbol	Min.	Typ.	Max.	Unit	Remark	
DCLK Frequency	Fclk	8	9	12	MHz		
DCLK Period	Tclk	125	111	83	ns		
HSYNC	Period Time	Th	487	531	598	DCLK	
	Display Period	Thdisp	-	480	-	DCLK	
	Back Porch	Thbp	3	43	43	DCLK	By H_Blanking setting
	Front Porch	Thfp	4	8	75	DCLK	
	Pulse Width	Thw	2	4	75	DCLK	
VSYNC	Period Time	Tv	276	292	321	H	
	Display Period	Tvdisp	-	272	-	H	
	Back Porch	Tvbp	2	12	12	H	By V_Blanking setting
	Front Porch	Tvfp	2	8	37	H	
	Pulse Width	Tvw	2	4	37	H	

Note: 1.It is necessary to keep Tvbp =12 and Thbp =43 in sync mode. DE mode is unnecessary to keep it.
 2.Thbp+Thfp >=7

6.4.3 SYNC-DE Mode

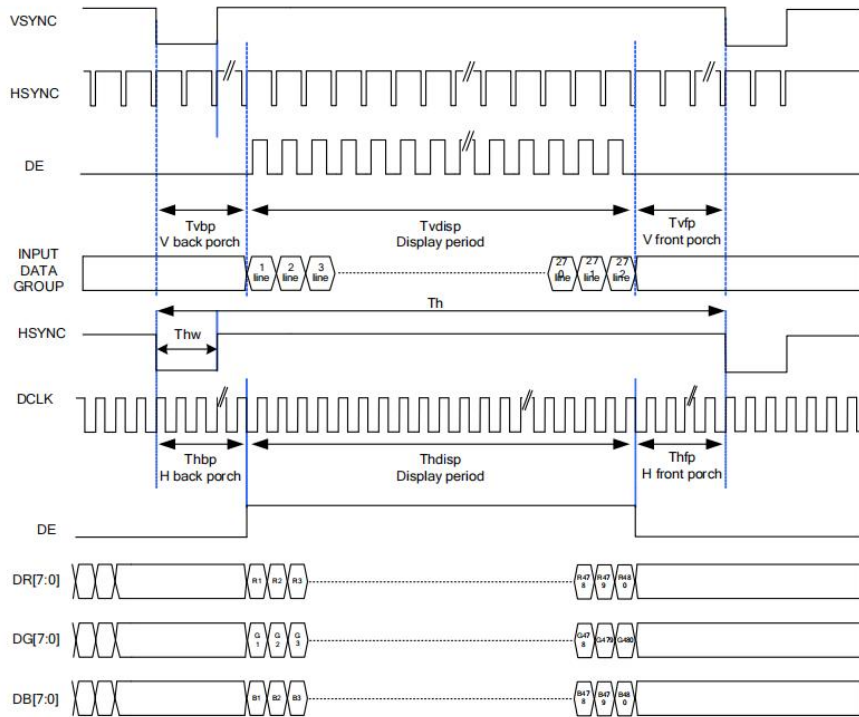

6.4.4 SYNC Mode

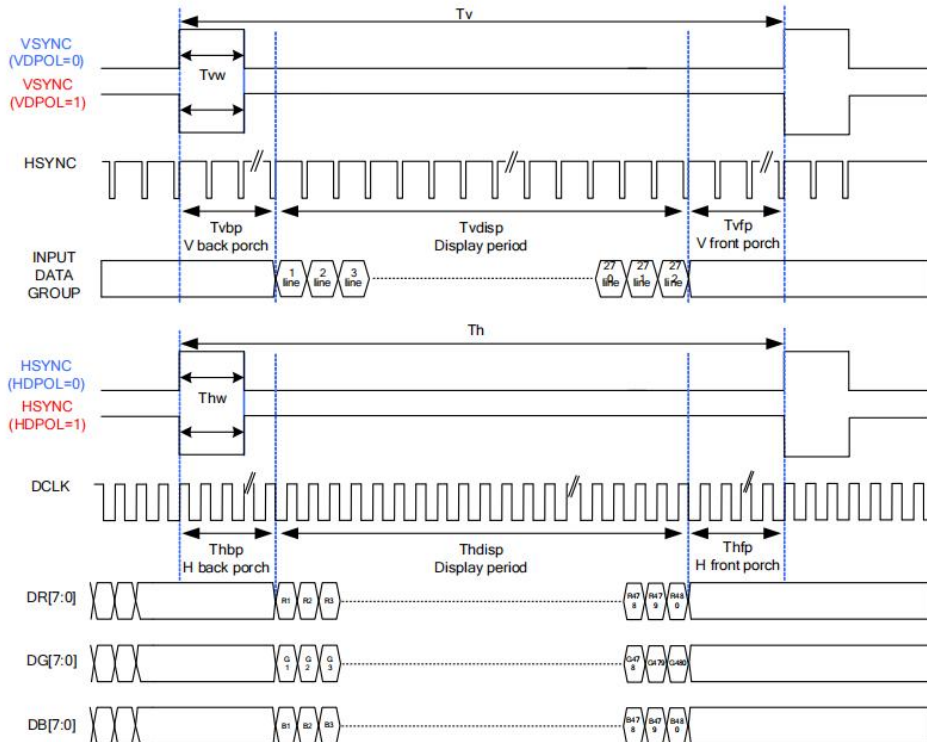

6.4.5 DE Mode

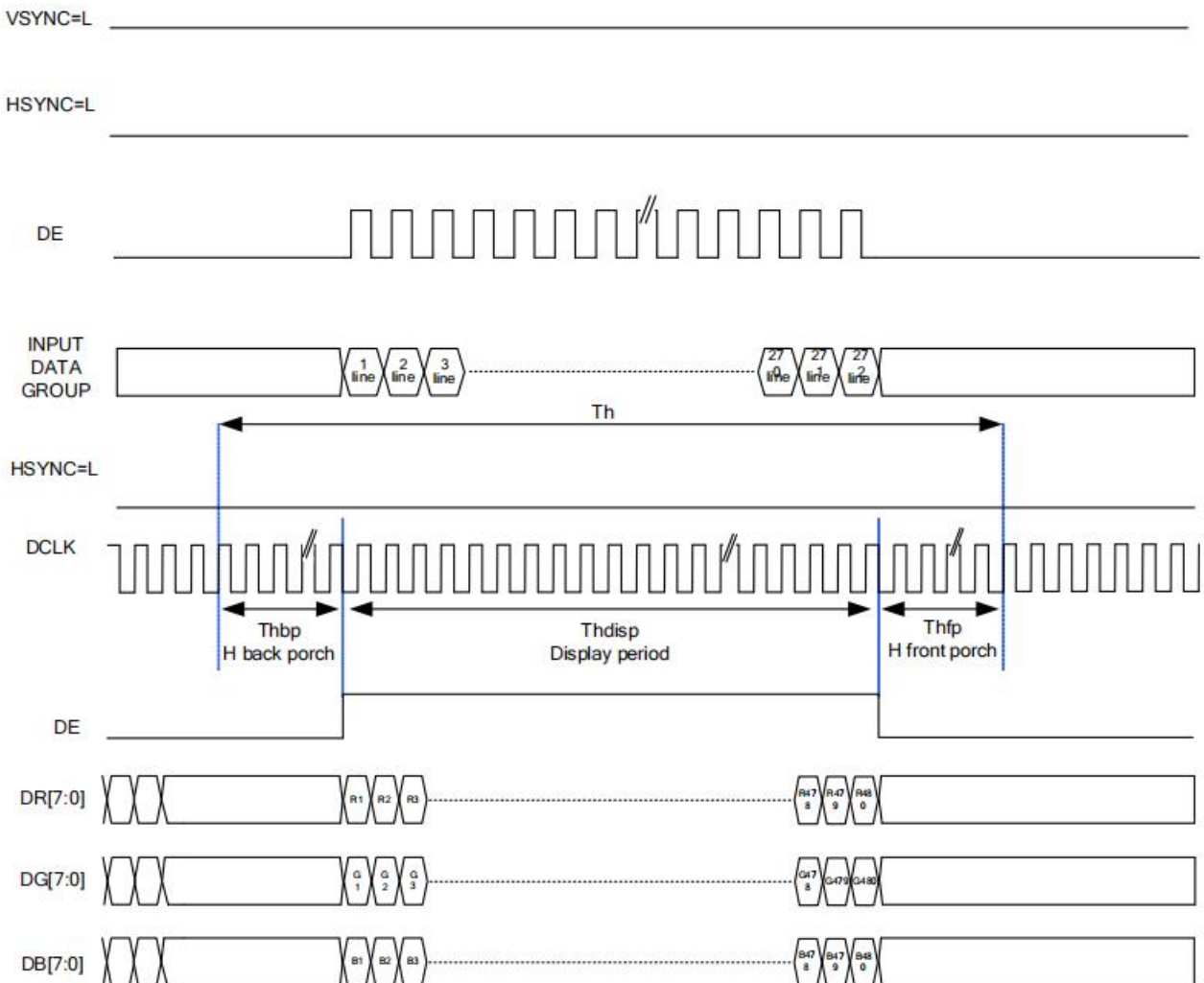

RGB Mode Selection Table

RGB Mode	DCLK	HSYNC	VSYNC	DE	DR[0:7]	DG[0:7]	DB[0:7]
Parallel RGB SYNC-DE Mode	Input	Input	Input	Input	Input	Input	Input
Parallel RGB SYNC Mode	Input	Input	Input	VSSD	Input	Input	Input
Parallel RGB DE Mode	Input	VSSD	VSSD	Input	Input	Input	Input

6.5 POWER ON/OFF SEQUENCE

6.5.1 Power On Sequence

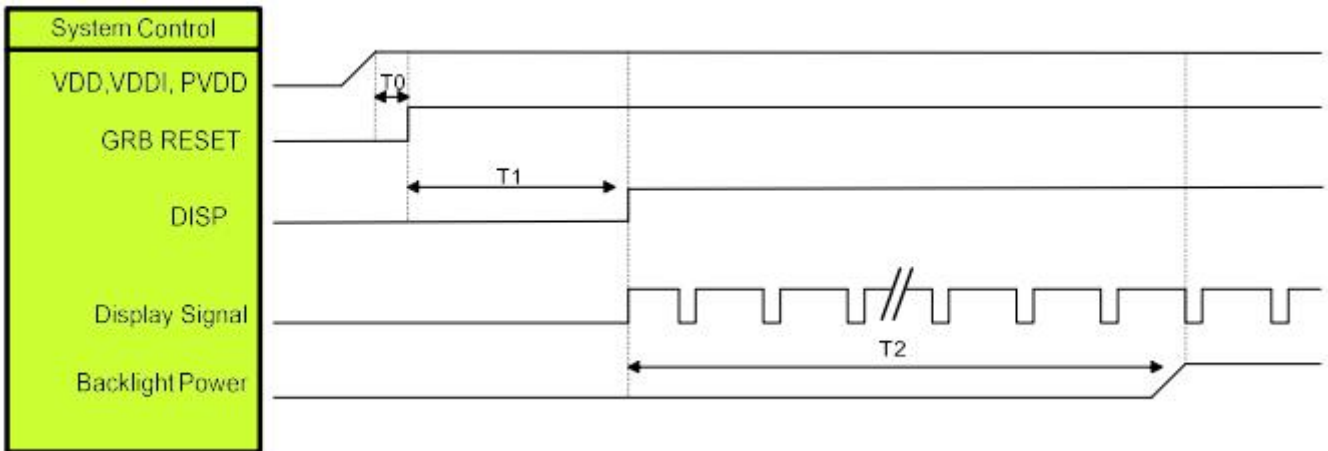

Symbol	Description	Min. Time	Unit
T0	System power stability to GRB RESET signal	0	ms
T1	GRB RESET= "High" to DISP="High"	10	ms
T2	Display Signal output to Backlight Power on	250	ms

6.5.2 Power Off Sequence

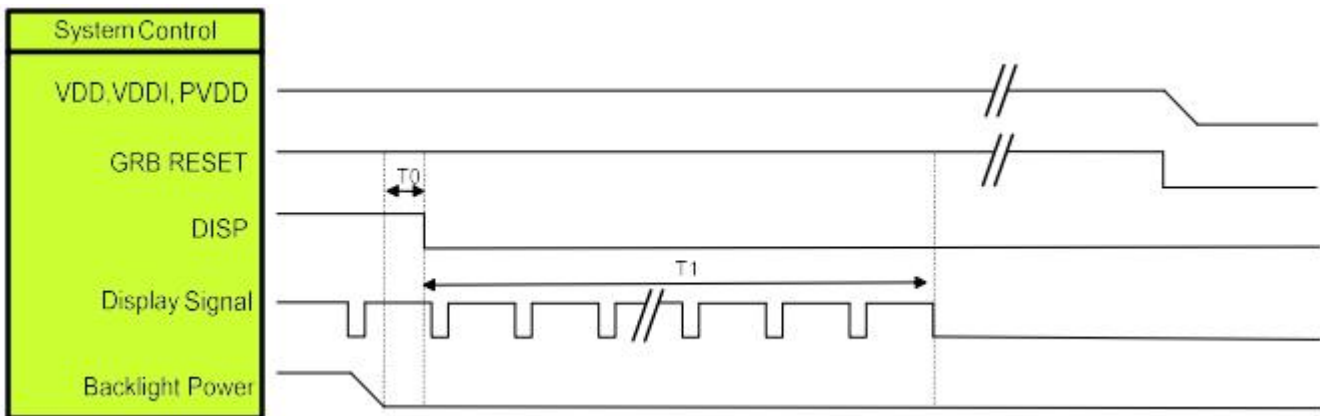

Symbol	Description	Min. Time	Unit
T0	Backlight Power off to DISP="Low"	5	ms
T1	DISP="Low" to IC internal voltage discharge complete	80	ms

7. Optical Characteristics

Item	Symbol	Condition	Min.	Typ.	Max.	Unit	Note	
Brightness	Bp	$\theta=0^\circ$ $\Phi=0^\circ$	600	700	-	Cd/m ²	1	
Uniformity	Δ Bp		75	80	-	%	1,2	
Viewing Angle	3:00	Cr \geq 10	-	85	-	Deg	3	
	6:00		-	85	-			
	9:00		-	85	-			
	12:00		-	85	-			
Contrast Ratio	Cr	$\theta=0^\circ$ $\Phi=0^\circ$	800	1000	-	-	4	
Response Time	T _r +T _f		-	30	35	ms	5	
Color of CIE Coordinate	W	x	$\theta=0^\circ$ $\Phi=0^\circ$	Typ -0.05	Typ +0.05	-	1,6	
		y				-		
	R	x				0.305		-
		y				0.336		-
	G	x				0.603		-
		y				0.307		-
	B	x				0.314		-
		y				0.557		-
S	x	0.145	-					
	y	0.153	-					
NTSC Ratio	S	-	50	-	%			

Note: The parameter is slightly changed by temperature, driving voltage and materiel

Note 1: The data are measured after LEDs are turned on for 5 minutes. LCM displays full white.

The brightness is the average value of 9 measured spots. Measurement equipment BM-7 (Φ5mm)

Measuring condition:

- Measuring surroundings: Dark room.
- Measuring temperature: $T_a=25\text{ }^\circ\text{C}$.
- Adjust operating voltage to get optimum contrast at the center of the display.

Measured value at the center point of LCD panel after more than 5 minutes while backlight turning on.

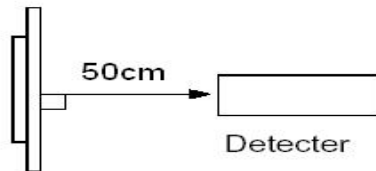

Note 2: The luminance uniformity is calculated by using following formula.

$$\Delta B_p = B_p (\text{Min.}) / B_p (\text{Max.}) \times 100 (\%)$$

$B_p (\text{Max.})$ = Maximum brightness in 9 measured spots

$B_p (\text{Min.})$ = Minimum brightness in 9 measured spots.

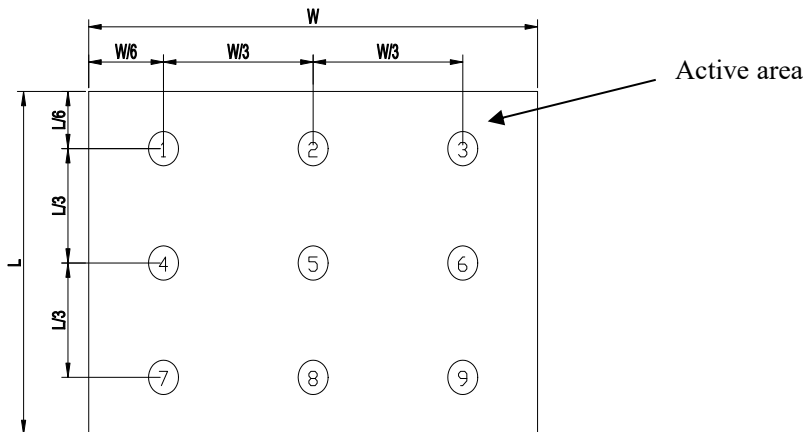

Note 3: The definition of viewing angle:
 Refer to the graph below marked by θ and Φ

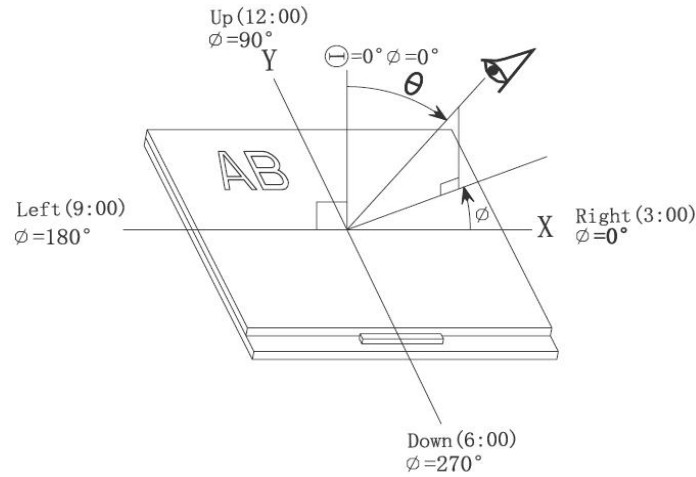

Note 4: Definition of contrast ratio.(Test LCD using DMS501)

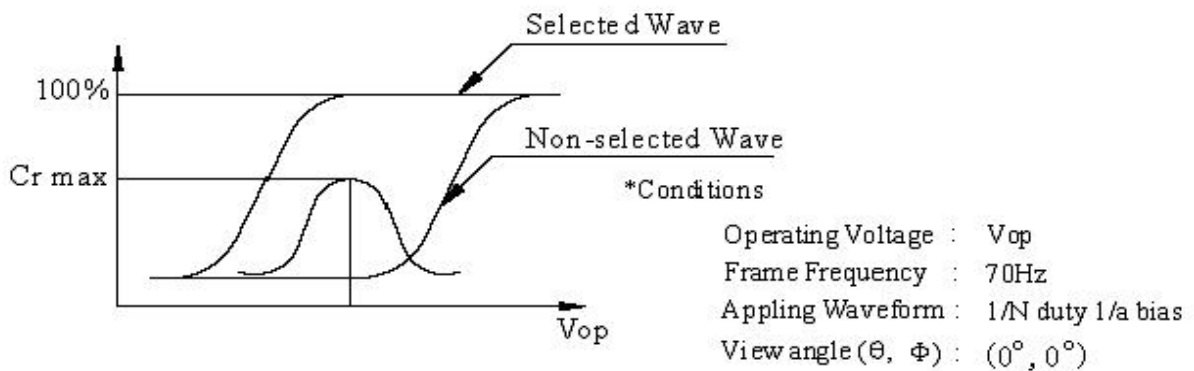

$$\text{Contrast ratio}(Cr) = \frac{\text{Brightness of selected dots}}{\text{Brightness of non-selected dots}}$$

Note 5: Definition of Response time. (Test LCD using DMS501):

The output signals of photo detector are measured when the input signals are changed from "black" to "white" (falling time) and from "white" to "black" (rising time), respectively. The response time is defined as the time interval between the 10% and 90% of amplitudes. Refer to figure as below.

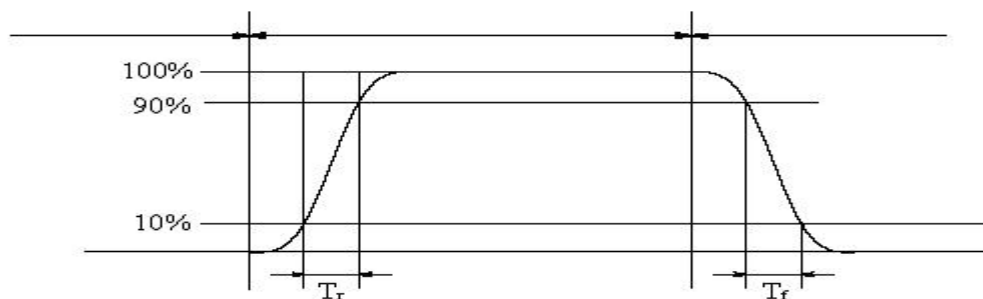

The definition of response time

Note 6: Definition of Color of CIE Coordinate and NTSC Ratio.

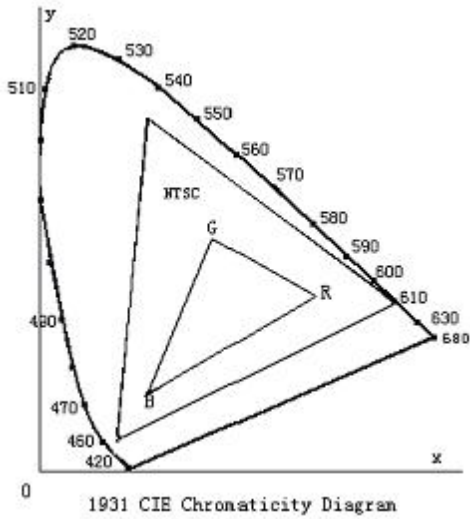

Color gamut:

$$S = \frac{\text{area of RGB triangle}}{\text{area of NTSC triangle}} \times 100\%$$

Note 7: Definition of cross talk.

Cross talk ratio(%) = $\frac{|\text{pattern A Brightness} - \text{pattern B Brightness}|}{\text{pattern A Brightness}} \times 100$

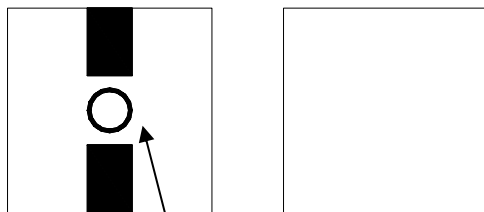

Pattern A

Pattern B

Measurement point(center)

Electric volume value = $3F \pm 3Hex$

8. Reliability Test Items and Criteria

Test Item	Test condition	Remark
High Temperature Storage	Ta = 80°C 120hrs	Note1,Note3, 4
Low Temperature Storage	Ta = -30°C 120hrs	Note1,Note3, 4
High Temperature Operation	Ta = 80°C 120hrs	Note2,Note3, 4
Low Temperature Operation	Ta = -30°C 120hrs	Note1,Note3, 4
Operation at High Temperature/Humidity	+60°C, 90%RH 120hrs	Note3, 4
Thermal Shock	-30°C/30 min ~ +80°C/30 min for a total 10 cycles, Start with cold temperature and end with high temperature.	Note3, 4
Package Drop Test	Height:60cm 1 corner, 3 edges, 6 surfaces	

Note 1: Ta is the ambient temperature of samples.

Note 2: Ts is the temperature of panel's surface.

Note 3: In the standard condition, there shall be no practical problem that may affect the display function. After the reliability test, the product only guarantees operation, but don't guarantee all of the cosmetic specification.

Note 4: Before cosmetic and function test, the product must have enough recovery time, at least 2 hours at room temperature

9. Precautions for Use of LCD Modules

9.1 Handling Precautions

9.1.1 *The display panel is made of glass. Do not subject it to a mechanical shock by dropping it from a high place, etc.*

9.1.2 *If the display panel is damaged and the liquid crystal substance inside it leaks out, be sure not to get any in your mouth, if the substance comes into contact with your skin or clothes, promptly wash it off using soap and water.*

9.1.3 *Do not apply excessive force to the display surface or the adjoining areas since this may cause the color tone to vary.*

9.1.4 *The polarizer covering the display surface of the LCD module is soft and easily scratched. Handle this polarizer carefully.*

9.1.5 *If the display surface is contaminated, breathe on the surface and gently wipe it with a soft dry cloth. If still not completely clear, moisten cloth with one of the following solvents:*

— Isopropyl alcohol — Ethyl alcohol

Solvents other than those mentioned above may damage the polarizer. Especially, do not use the following:

— Water — Ketone — Aromatic solvents

9.1.6 *Do not attempt to disassemble the LCD Module.*

9.1.7 *If the logic circuit power is off, do not apply the input signals.*

9.1.8 *To prevent destruction of the elements by static electricity, be careful to maintain an optimum work environment.*

a. Be sure to ground the body when handling the LCD Modules.

b. Tools required for assembly, such as soldering irons, must be properly ground.

c. To reduce the amount of static electricity generated, do not conduct assembly and other work under dry conditions.

d. The LCD Module is coated with a film to protect the display surface. Be care when peeling off this protective film since static electricity may be generated.

9.2 Storage precautions

9.2.1 *When storing the LCD modules, avoid exposure to direct sunlight or to the light of fluorescent lamps.*

9.2.2 *The LCD modules should be stored under the storage temperature range. If the LCD modules will be stored for a long time, the recommend condition is:*

Temperature : 0 °C ~ 40 °C

Relatively humidity: ≤80%

9.2.3 *The LCD modules should be stored in the room without acid, alkali and harmful gas.*

9.3 *The LCD modules should be no falling and violent shocking during transportation, and also should avoid excessive press, water, damp and sunshine.*

END