

Category: 螺钉接线/Plug-in terminal-plug

Product name: 302901

Product Description: 6.2mm , 800V , 24A CE,UL

Product Picture

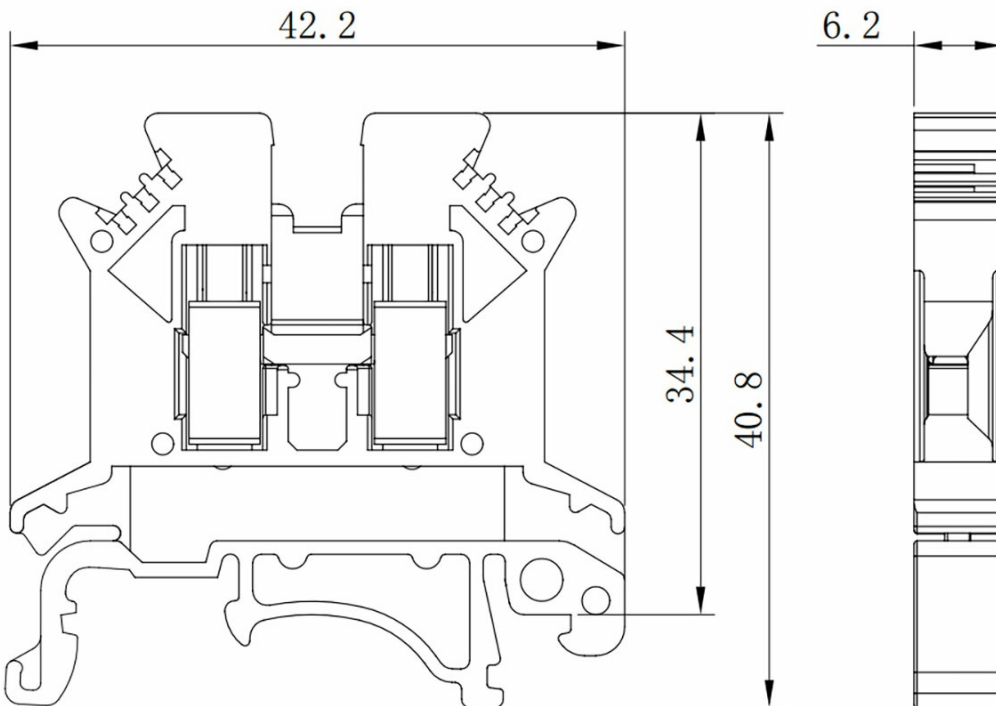

基本信息 /Basic Information

产品型号 SUPU ID	302901
宽度 Width	6.2mm
产品层数 Number of levels	1
接线位数 Number of connections	2
接线方式 Connection method	螺钉接线 Screw connection
防护等级 Protection Level	IP20

工作温度 Work temperature	-40~+105°C
--------------------------	------------

IEC数据 /IEC Data

额定电流 Rated Current	24A
额定电压 Rated Voltage	800V
过压类别 Overvoltage category	III
污染等级 Pollution degree	3
额定冲击电压 Rated impulse voltage	8.0KV
刚性导线截面积 Conductor cross section solid	0.2-4mm ²
柔性导线截面积 Conductor cross section flexible	0.2-2.5mm ²
柔性导线截面积，带绝缘管套 Conductor cross section flexible,with furrule	0.2-2.5mm ²
锁线螺钉规格 Locking screw Specification	M3
额定扭矩 Rated Torque	0.6N.m
固定螺钉规格 Fixed Screw Specification	-
额定扭矩 Rated Torque	-
剥线长度 Stripping length	7-8mm

UL数据 /UL Data

使用组别 Use group	B	C	D
额定电流 Rated Current	20A	20A	-
额定电压 Rated Voltage	300V	300V	-
额定接线容量 Rated cross section	30-12AWG		

材料信息 /Material Data

绝缘材料 Insulation material	PA66
绝缘材料组别 Insulation material group	I
阻燃等级，符合UL94 Flame retardant grade, UL94 compliance	V0
导体材料 Contact material	Copper alloy
导体表面镀层 Surface characteristics	Sn,Plated

产品认证 /Product Certification

认证图标
Certificate



UL证书号
UL file No.

VDE证书号
VDE No.

TUV证书号
TUV No.

Ningbo Supu Electronics Co.,Ltd

Zip code: 315303

Fax: +86 574-63288170

E-mail : askme@supu.cn

Address: No. 625, Kandun Town Street, Cixi
City, Zhejiang Province

Switchboard: +86 574-63288158

E-mail : askme@supu.cn

Service Hotline: 400-626-6336



Code
