

Surface Mount Super Fast Recovery Rectifier

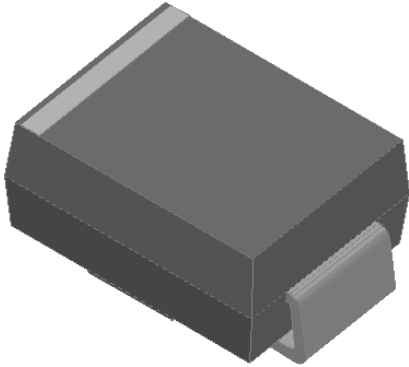

Features

- Low profile package
- Ideal for automated placement
- Glass passivated chip junction
- High forward surge capability
- Super Fast reverse recovery time
- Meets MSL level 1, per J-STD-020, LF maximum peak of 260 °C

Typical Applications

For use in high frequency rectification of power supplies, inverters, converters, and freewheeling diodes for consumer and telecommunication.

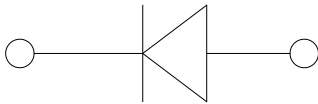

Mechanical Data

- **Package:** DO-214AA (SMB)
Molding compound meets UL 94 V-0 flammability rating, RoHS-compliant, halogen-free
- **Terminals:** Tin plated leads, solderable per J-STD-002 and JESD22-B102
- **Polarity:** Cathode line denotes the cathode end

■ Maximum Ratings (T_a=25°C Unless otherwise specified)

PARAMETER	SYMBOL	UNIT	ES2A	ES2B	ES2C	ES2D	ES2F	ES2G	ES2H	ES2J	ES2K
Device marking code			ES2A	ES2B	ES2C	ES2D	ES2F	ES2G	ES2H	ES2J	ES2K
Repetitive peak reverse voltage	VRRM	V	50	100	150	200	300	400	500	600	800
Average rectified output current @60Hz sine wave, resistance load, TL (Fig.1)	I _O	A	2.0								
Surge(non-repetitive)forward current @60Hz half-sine wave,1 cycle, T _a =25°C	I _{FSM}	A	50								
Storage temperature	T _{stg}	°C	-55~+150								
Junction temperature	T _j	°C	-55~+150								

■ Electrical Characteristics (T_a=25°C Unless otherwise specified)

PARAMETER	SYMBOL	UNIT	TEST CONDITIONS	ES2A	ES2B	ES2C	ES2D	ES2F	ES2G	ES2H	ES2J	ES2K
Maximum instantaneous forward voltage drop per diode	V _F	V	I _{FM} =2.0A	0.95				1.3		1.7		1.85
Maximum reverse recovery time	t _r	ns	I _F =0.5A, I _R =1.0A, I _F =0.25A	35								
Maximum DC reverse current at rated DC blocking voltage per diode @ V _{RM} =VRRM	I _{RRM}	μA	T _a =25°C	5.0								
			T _a =125°C	100								



ES2A THRU ES2K

■ Thermal Characteristics (T_a=25°C Unless otherwise specified)

PARAMETER	SYMBOL	UNIT	ES2A	ES2B	ES2C	ES2D	ES2F	ES2G	ES2H	ES2J	ES2K
Thermal resistance	R _{θJ-A} (1)	°C/W	85 ¹⁾								
	R _{θJ-L} (1)		22 ¹⁾								

Note:
 (1) Thermal resistance from junction to ambient and from junction to lead mounted on P.C.B. with 0.2" x 0.2" (5.0 mm x 5.0 mm) copper pad areas

■ Characteristics (Typical)

FIG1: I_o-T_L Curve

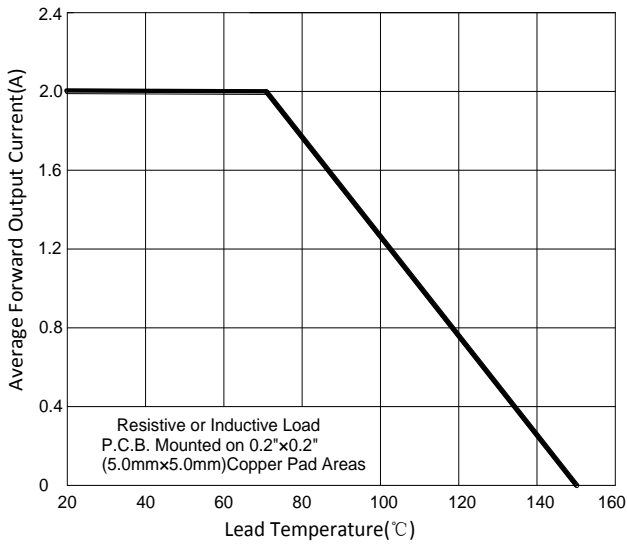

FIG2: Surge Forward Current Capability

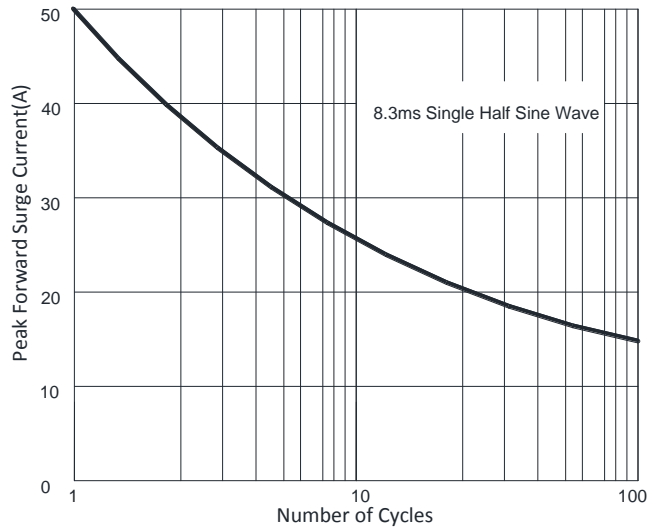

FIG3: Forward Voltage

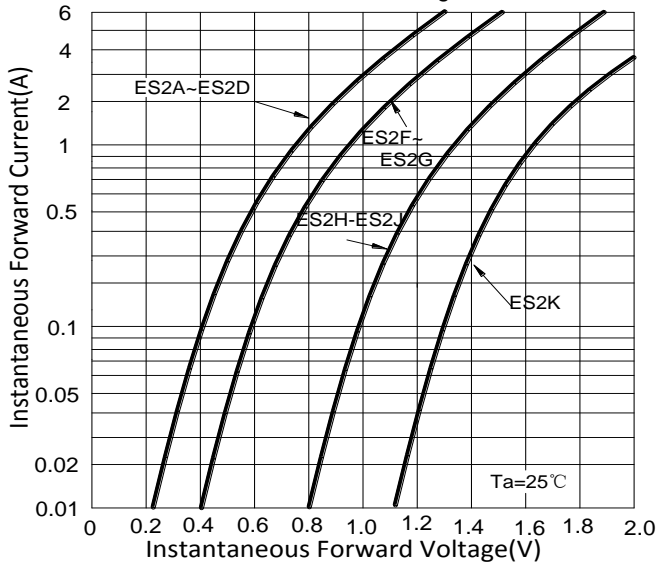
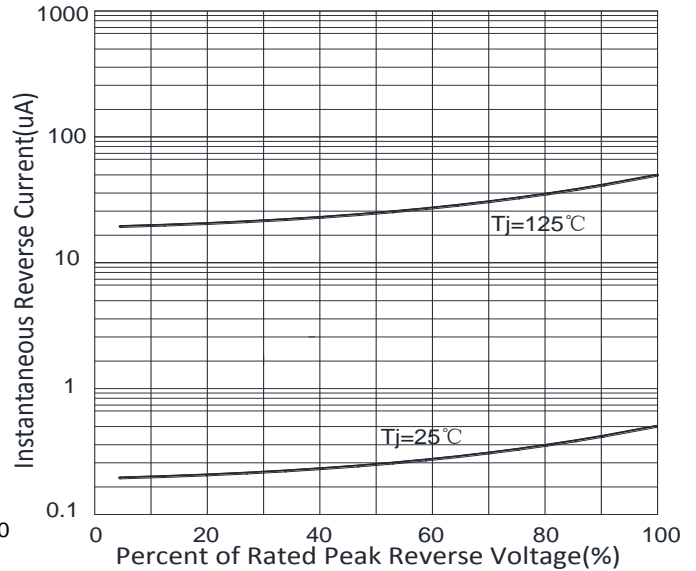

FIG4: Typical Reverse Characteristics





ES2A THRU ES2K

FIG.5: Diagram of circuit and Testing wave form of reverse recovery time

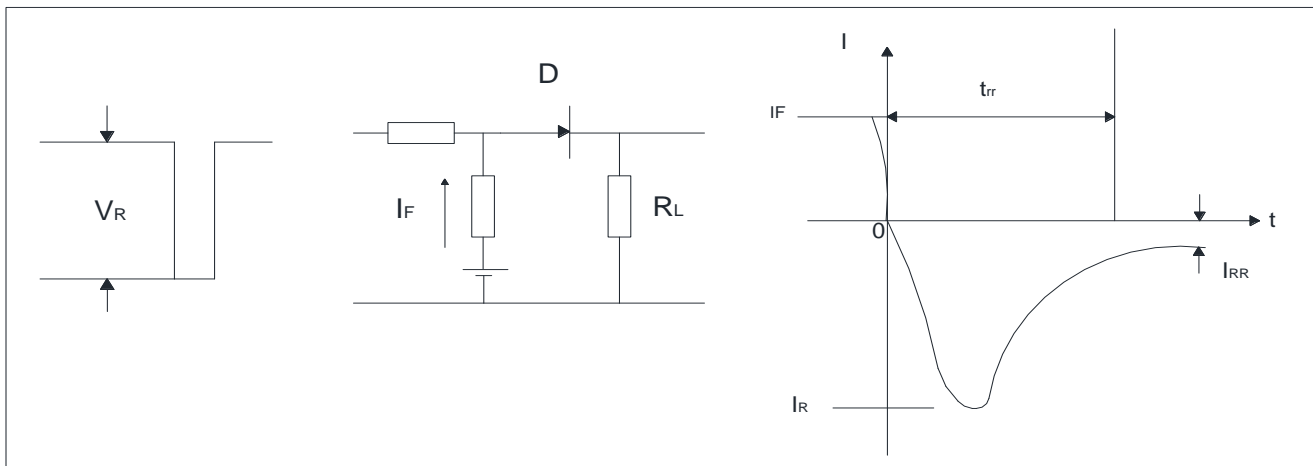

Ordering Information (Example)

PREFERED P/N	PACKING CODE	UNIT WEIGHT(g)	MINIMUM PACKAGE(pcs)	INNER BOX QUANTITY(pcs)	OUTER CARTON QUANTITY(pcs)	DELIVERY MODE
ES2A-ES2K	F1	Approximate 0.096	3000	6000	48000	13" reel
ES2A-ES2K	F2	Approximate 0.096	750	3000	24000	7" reel
ES2A-ES2K	F3	Approximate 0.096	500	2000	16000	7" reel

Outline Dimensions

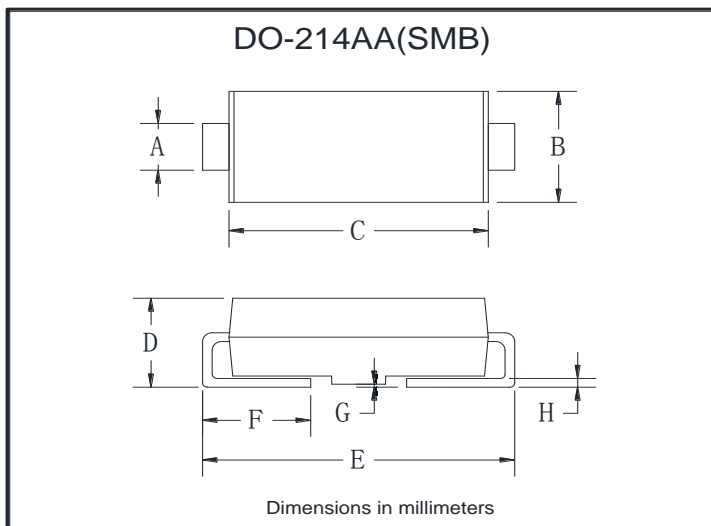

DO-214AA(SMB)		
Dim	Min	Max
A	1.85	2.15
B	3.30	3.94
C	4.25	4.75
D	1.99	2.61
E	5.21	5.59
F	0.90	1.41
G	0.10	0.20
H	0.15	0.31



ES2A THRU ES2K

■ Suggested pad layout

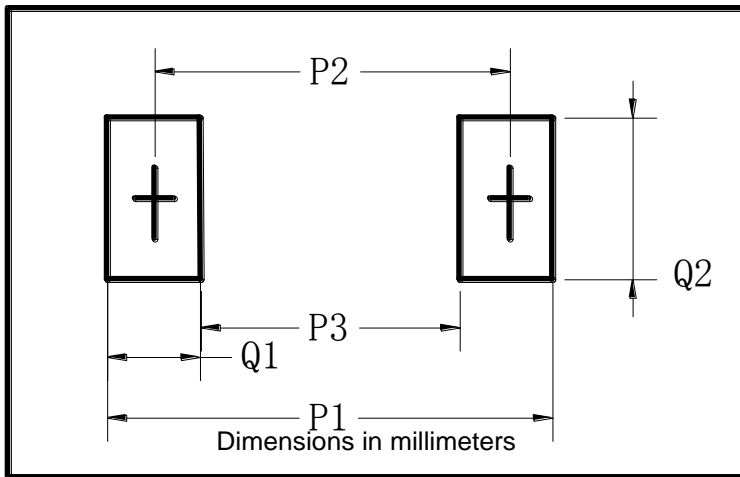

DO-214AA(SMB)	
Dim	Millimeters
P1	6.8
P2	4.3
P3	1.8
Q1	2.5
Q2	2.3



ES2A THRU ES2K

Disclaimer

The information presented in this document is for reference only. Yangzhou Yangjie Electronic Technology Co., Ltd. reserves the right to make changes without notice for the specification of the products displayed herein to improve reliability, function or design or otherwise.

The product listed herein is designed to be used with ordinary electronic equipment or devices, and not designed to be used with equipment or devices which require high level of reliability and the malfunction of which would directly endanger human life (such as medical instruments, transportation equipment, aerospace machinery, nuclear-reactor controllers, fuel controllers and other safety devices), Yangjie or anyone on its behalf, assumes no responsibility or liability for any damages resulting from such improper use of sale.

This publication supersedes & replaces all information previously supplied. For additional information, please visit our website [http:// www.21yangjie.com](http://www.21yangjie.com) , or consult your nearest Yangjie's sales office for further assistance.