

150V N-Channel Enhancement Mode Power MOSFET

Description

WMK115N15HG2 uses Wayon's 2nd generation power trench MOSFET technology that has been especially tailored to minimize the on-state resistance and yet maintain superior switching performance. This device is well suited for high efficiency fast switching applications.

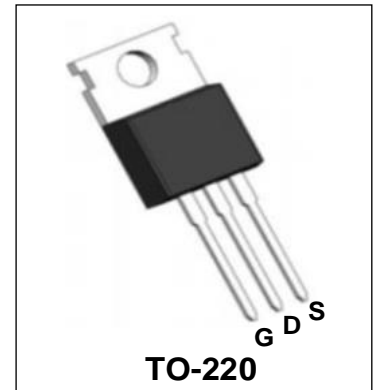

Features

- $V_{DS} = 150V$, $I_D = 90A$
 $R_{DS(on)} < 11.5m\Omega @ V_{GS} = 10V$
- Low $R_{DS(ON)}$
- 100% EAS Guaranteed
- High Speed Power Switching

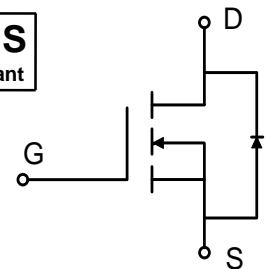

Applications

- Hard Switching and High Speed Circuit
- DC/DC Converter
- Synchronous Rectification in SMPS

Absolute Maximum Ratings (T_C = 25°C, unless otherwise noted)

| Parameter | Symbol | Value | Unit |
|--|----------------|-----------------------|------|
| Drain-Source Voltage | V_{DS} | 150 | V |
| Gate-Source Voltage | V_{GS} | ±20 | V |
| Continuous Drain Current | I_D | T _C =25°C | 90 |
| | | T _C =100°C | 57 |
| Pulsed Drain Current ⁴ | I_{DM} | 360 | A |
| Single Pulse Avalanche Energy ³ | EAS | 245 | mJ |
| Total Power Dissipation | P_D | 173.6 | W |
| Operating Junction and Storage Temperature Range | T_J, T_{STG} | -55 to 150 | °C |

Thermal Characteristics

| Parameter | Symbol | Value | Unit |
|--|-----------------|-------|------|
| Thermal Resistance from Junction-to-Ambient ¹ | $R_{\theta JA}$ | 58 | °C/W |
| Thermal Resistance from Junction-to-Case | $R_{\theta JC}$ | 0.72 | °C/W |

Electrical Characteristics ($T_C = 25^\circ\text{C}$, unless otherwise noted)

| Parameter | Symbol | Test Conditions | Min. | Typ. | Max. | Unit |
|--|-------------------------|---|------|------|-----------|------------|
| Static Characteristics | | | | | | |
| Drain-Source Breakdown Voltage | $V_{(BR)DSS}$ | $V_{GS} = 0V, I_D = 250\mu A$ | 150 | - | - | V |
| Gate-body Leakage Current | I_{GSS} | $V_{DS} = 0V, V_{GS} = \pm 20V$ | - | - | ± 100 | nA |
| Zero Gate Voltage Drain Current | $T_J=25^\circ\text{C}$ | I_{DSS} $V_{DS} = 150V, V_{GS} = 0V$ | - | - | 1 | μA |
| | $T_J=100^\circ\text{C}$ | | - | - | 100 | |
| Gate-Threshold Voltage | $V_{GS(th)}$ | $V_{DS} = V_{GS}, I_D = 250\mu A$ | 2 | 3 | 4 | V |
| Drain-Source On-Resistance ² | $R_{DS(on)}$ | $V_{GS} = 10V, I_D = 20A$ | - | 9.1 | 11.5 | m Ω |
| Forward Transconductance ² | g_{fs} | $V_{DS} = 5V, I_D = 20A$ | - | 66 | - | S |
| Dynamic Characteristics | | | | | | |
| Input Capacitance | C_{iss} | $V_{DS} = 75V, V_{GS} = 0V, f = 1MHz$ | - | 3520 | - | μF |
| Output Capacitance | C_{oss} | | - | 262 | - | |
| Reverse Transfer Capacitance | C_{rss} | | - | 9.8 | - | |
| Switching Characteristics | | | | | | |
| Gate Resistance | R_g | $V_{DS} = 0V, V_{GS} = 0V, f = 1MHz$ | - | 2.4 | - | Ω |
| Total Gate Charge | Q_g | $V_{GS} = 10V, V_{DD} = 75V, I_D = 20A$ | - | 45 | - | nC |
| Gate-Source Charge | Q_{gs} | | - | 18 | - | |
| Gate-Drain Charge | Q_{gd} | | - | 8.8 | - | |
| Turn-On Delay Time | $t_{d(on)}$ | $V_{GS} = 10V, V_{DD} = 75V, R_G = 10\Omega, I_D = 20A$ | - | 18 | - | ns |
| Rise Time | t_r | | - | 9 | - | |
| Turn-Off Delay Time | $t_{d(off)}$ | | - | 32 | - | |
| Fall Time | t_f | | - | 13 | - | |
| Drain-Source Body Diode Characteristics | | | | | | |
| Diode Forward Voltage ² | V_{SD} | $I_F = 20A, V_{GS} = 0V$ | - | - | 1.2 | V |
| Continuous Source Current ^{1,5} | I_S | $V_G = V_D = 0V$, Force Current | - | - | 90 | A |
| Reverse Recovery Time | t_{rr} | $V_R = 75V, I_F = 20A, dI_F/dt = 100A/\mu s$ | - | 81.6 | - | ns |
| Reverse Recovery Charge | Q_{rr} | | - | 162 | - | nC |

Notes:

- The data tested by surface mounted on a 1 inch² FR-4 board with 2OZ copper.
- The data tested by pulsed, pulse width $\leq 300\mu s$, duty cycle $\leq 2\%$
- The EAS data shows Max. rating. The test condition is $V_{DD}=50V, V_{GS}=10V, L=0.4mH, I_{AS}=35A$
- Repetitive rating, pulse width limited by junction temperature $T_{J(MAX)}=150^\circ\text{C}$.
- The data is theoretically the same as I_D and I_{DM} , in real applications, should be limited by total power dissipation.

Typical Characteristics

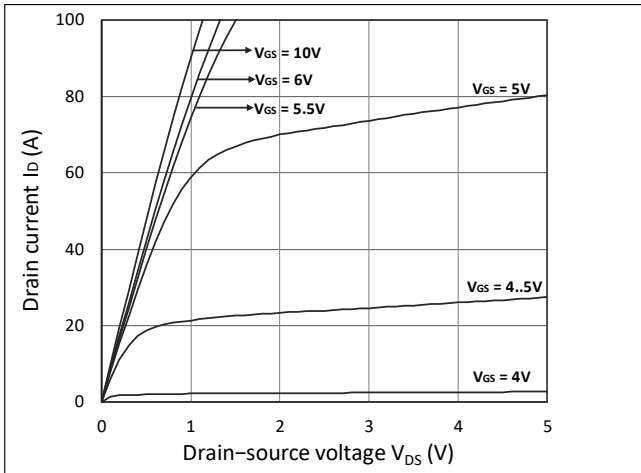

Figure 1. Output Characteristics

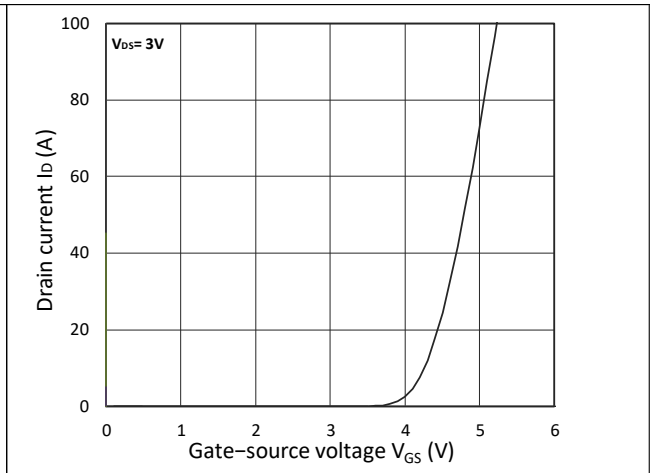

Figure 2. Transfer Characteristics

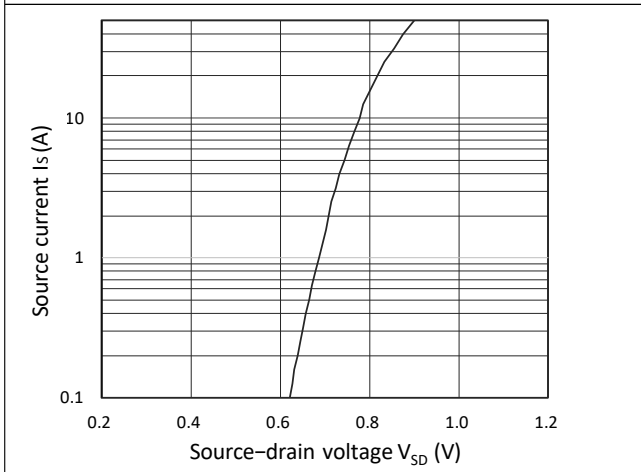

Figure 3. Forward Characteristics of Reverse

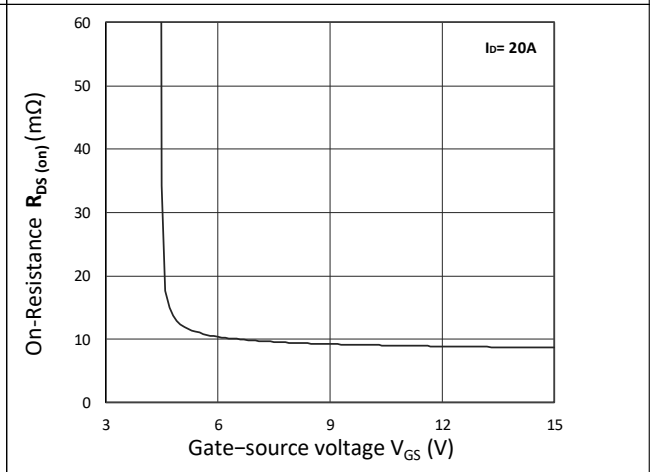

Figure 4. $R_{DS(ON)}$ vs. V_{GS}

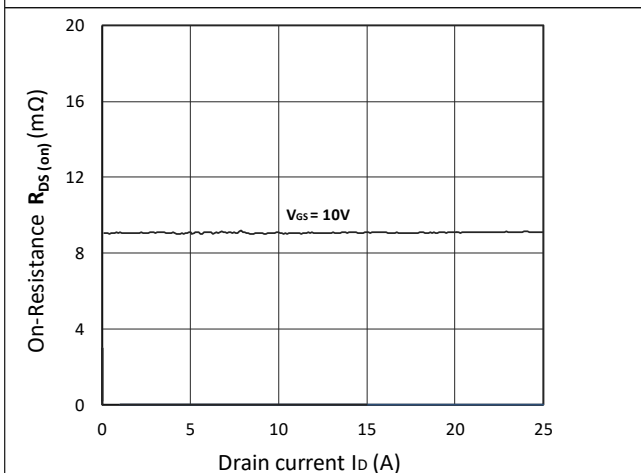

Figure 5. $R_{DS(ON)}$ vs. I_D

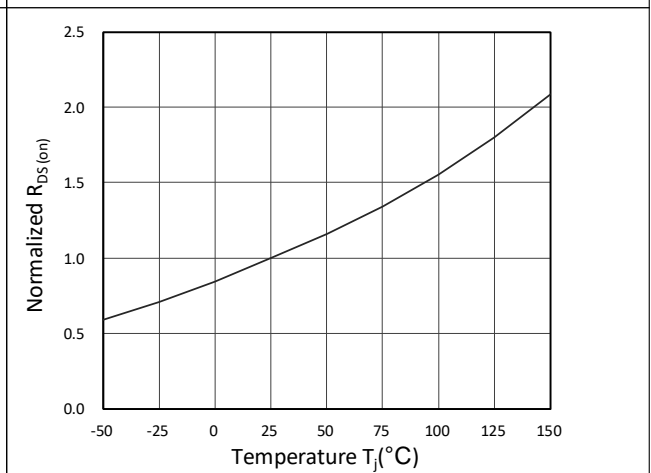

Figure 6. Normalized $R_{DS(ON)}$ vs. Temperature

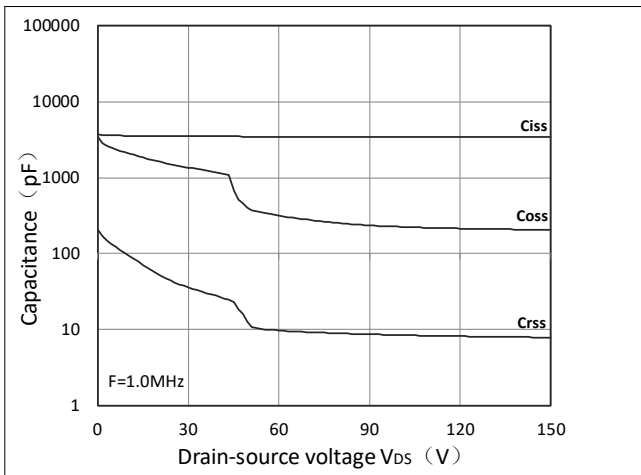

Figure 7. Capacitance Characteristics

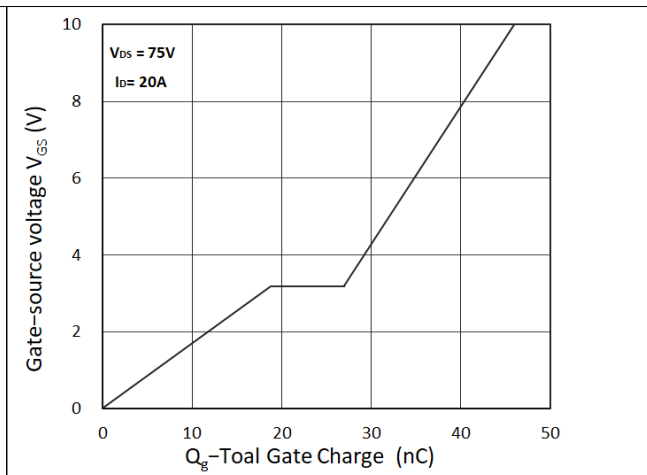

Figure 8. Gate Charge Characteristics

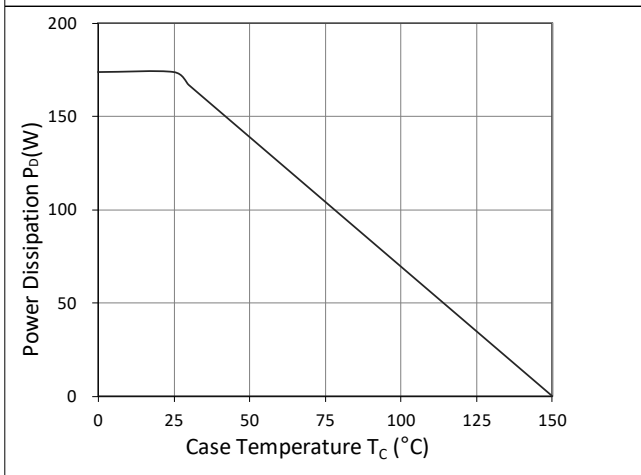

Figure 9. Power Dissipation

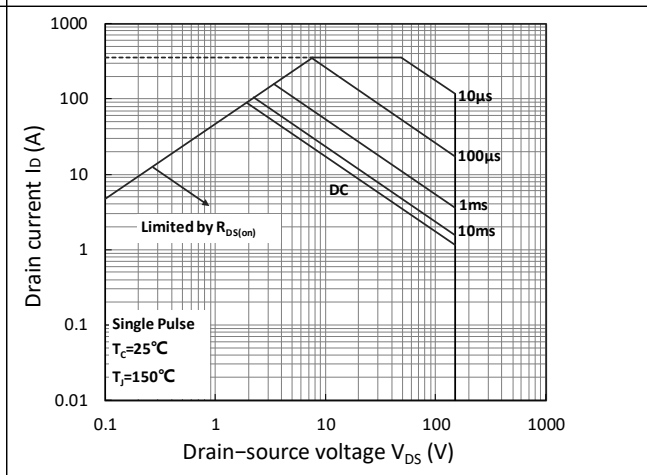

Figure 10. Safe Operating Area

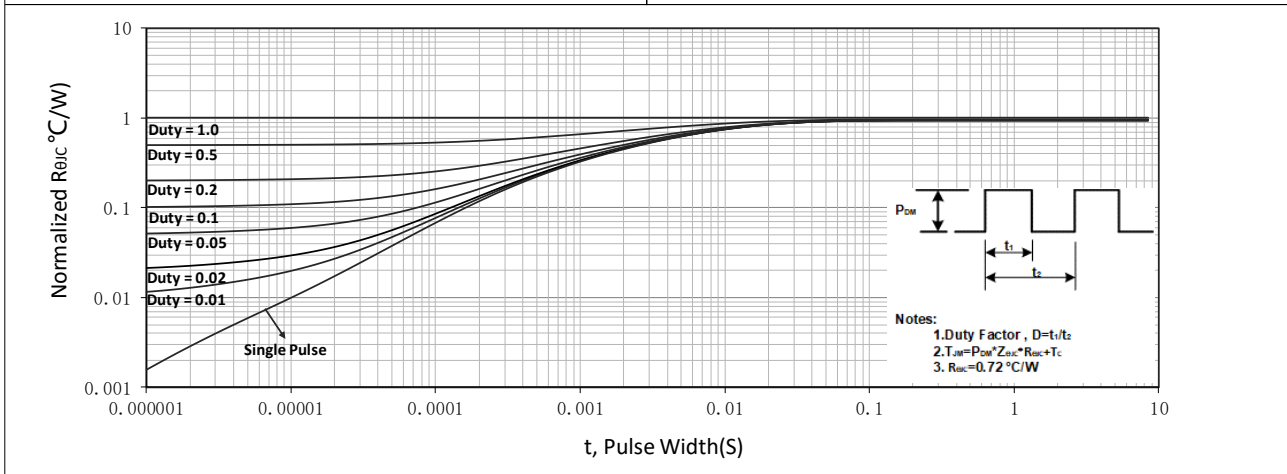

Figure 11. Normalized Maximum Transient Thermal Impedance

Test Circuit

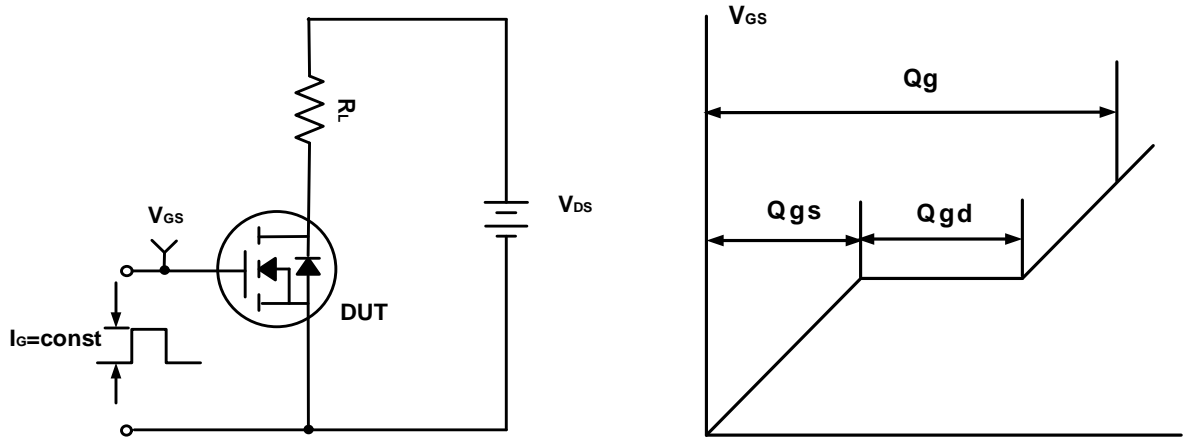

Figure A. Gate Charge Test Circuit & Waveforms



Figure B. Switching Test Circuit & Waveforms

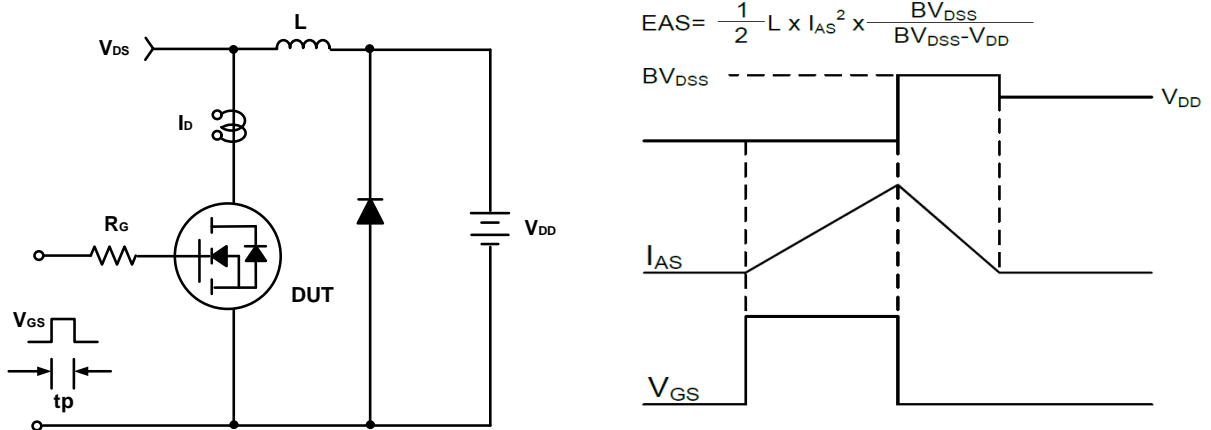
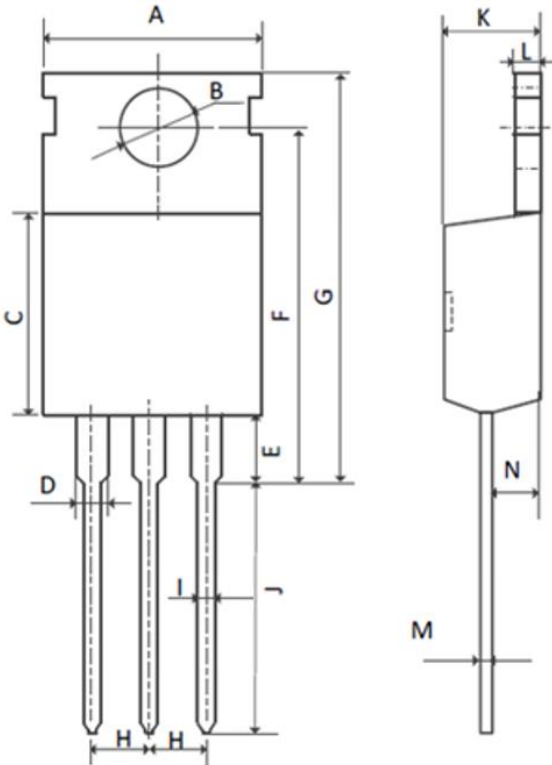

Figure C. Unclamped Inductive Switching Circuit & Waveforms

Mechanical Dimensions for TO-220

COMMON DIMENSIONS



| SYMBOL | MM | |
|--------|----------|-------|
| | MIN | MAX |
| A | 9.70 | 10.30 |
| B | 3.40 | 3.80 |
| C | 8.80 | 9.40 |
| D | 1.17 | 1.47 |
| E | 2.60 | 3.50 |
| F | 15.10 | 16.70 |
| G | 19.55MAX | |
| H | 2.54REF | |
| I | 0.70 | 0.95 |
| J | 9.35 | 11.00 |
| K | 4.30 | 4.77 |
| L | 1.20 | 1.45 |
| M | 0.40 | 0.65 |
| N | 2.20 | 2.60 |

Ordering Information

| Part | Package | Marking | Packing method |
|--------------|---------|--------------|----------------|
| WMK115N15HG2 | TO-220 | WMK115N15HG2 | Tube |

Marking Information

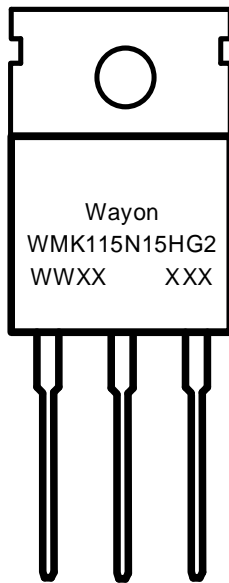

WMK115N15HG2= Device code

WWXX XXX= Date code

Contact Information.

No.1001, Shiwan(7) Road, Pudong District, Shanghai, P.R.China.201207

Tel: 86-21-50310888 Fax: 86-21-50757680 Email: market@way-on.com

WAYON website: <http://www.way-on.com>

For additional information, please contact your local Sales Representative.

 is registered trademarks of Wayon Corporation.

Disclaimer

WAYON reserves the right to make changes without further notice to any Products herein to improve reliability, function, or design. The Products are not designed for use in hostile environments, including, without limitation, aircraft, nuclear power generation, medical appliances, and devices or systems in which malfunction of any Product can reasonably be expected to result in a personal injury. The information given in this document shall in no event be regarded as a guarantee of conditions or characteristics. WAYON does not assume any liability for infringement of patents, copyrights, or other intellectual property rights of third parties by or arising from the use of products or technical information described in this document.