

FEATURES

* International standard package

APPLICATIONS

- * DC motor control
- * Softstart AC motor controller
- * Light, heat and temperature control

ADVANTAGES

- * Space and weight savings
- * Simple mounting with two screws
- * Improved temperature and power cycling
- * Reduced protection circuits

Symbol	Test Conditions	Maximum Ratings	Unit
I_{TRMS} , I_{FRMS} I_{TAVM} , I_{FAVM}	$T_{VJ}=T_{VJM}$ $T_C=85^{\circ}C$; 180° sine	42 67	A
I_{TSM} , I_{FSM}	$T_{VJ}=45^{\circ}C$ t=10ms (50Hz), sine $V_R=0$ t=8.3ms (60Hz), sine	1700 1800	A
	$T_{VJ}=T_{VJM}$ t=10ms(50Hz), sine $V_R=0$ t=8.3ms(60Hz), sine	1540 1640	
i_{zdt}	$T_{VJ}=45^{\circ}C$ t=10ms (50Hz), sine $V_R=0$ t=8.3ms (60Hz), sine	14450 13500	A2s
	$T_{VJ}=T_{VJM}$ t=10ms(50Hz), sine $V_R=0$ t=8.3ms(60Hz), sine	11850 11300	
$(di/dt)_{cr}$	$T_{VJ}=T_{VJM}$ repetitive, $I_T=45A$ f=50Hz, $t_p=200\mu s$ $V_D=2/3V_{DRM}$ $I_G=0.45A$ non repetitive, $I_T=I_{TAVM}$ $di_G/dt=0.45A/\mu s$	150 500	A/us
$(dv/dt)_{cr}$	$T_{VJ}=T_{VJM}$; $V_{DR}=2/3V_{DRM}$ $R_{GK}=\text{ ; method 1 (linear voltage rise)}$	1000	V/us
P_{GM}	$T_{VJ}=T_{VJM}$ $t_p=30\mu s$ $I_T=I_{TAVM}$ $t_p=300\mu s$	10	W
		5	
P_{GAV}		0.5	W
V_{RGM}		10	V
T_{VJ} T_{VJM} T_{stg}		-40...+125	°C
		125	
		-40...+125	
V_{ISOL}	50/60Hz, RMS t=1min $I_{ISOL}<1mA$ t=1s	3000	V~
		3600	
M_d	Mounting torque (M5) Terminal connection torque (M5)	2.5-4.0/22-35	Nm/lb.in.
		2.5-4.0/22-35	
Weight	Typical including screws	160	g

Symbol	Test Conditions	Maximum Ratings	Unit
IRRM, IDRM	TVJ=TVJM; VR=VRRM; VD=VDRM	5	mA
VT, VF	IT, IF=92A; TVJ=25oC	1.40	V
VTO	For power-loss calculations only (TVJ=125oC)	0.85	V
rT		3.2	mΩ
VGT	VD=6V; TVJ=25oC TVJ=-40oC	2.5 2.6	V
IGT	VD=6V; TVJ=25oC TVJ=-40oC	150 200	mA
VGD	TVJ=TVJM; VD=2/3VDRM	0.2	V
IGD		10	mA
IL	TVJ=25oC; tp=10us; VD=6V IL IG=0.45A; diG/dt=0.45A/us	450	mA
IH	TVJ=25oC; VD=6V; RGK=	200	mA
tgd	TVJ=25oC; VD=1/2VDRM IG=0.45A; diG/dt=0.45A/us	2	us
tq	TVJ=TVJM; IT=20A; tp=200us; -di/dt=10A/us VR=100V; dv/dt=20V/us; VD=2/3VDRM	185	us
QS	TVJ=TVJM; IT, IF=25A; -di/dt=0.64A/us	170	uC
IRM		45	A
RthJC	per thyristor/diode; DC current per module	0.3 0.15	K/W
RthJK	per thyristor/diode; DC current per module	0.5 0.25	K/W
dS	Creeping distance on surface	12.7	mm
dA	Strike distance through air	9.6	mm
a	Maximum allowable acceleration	50	m/s ²

Outline Table

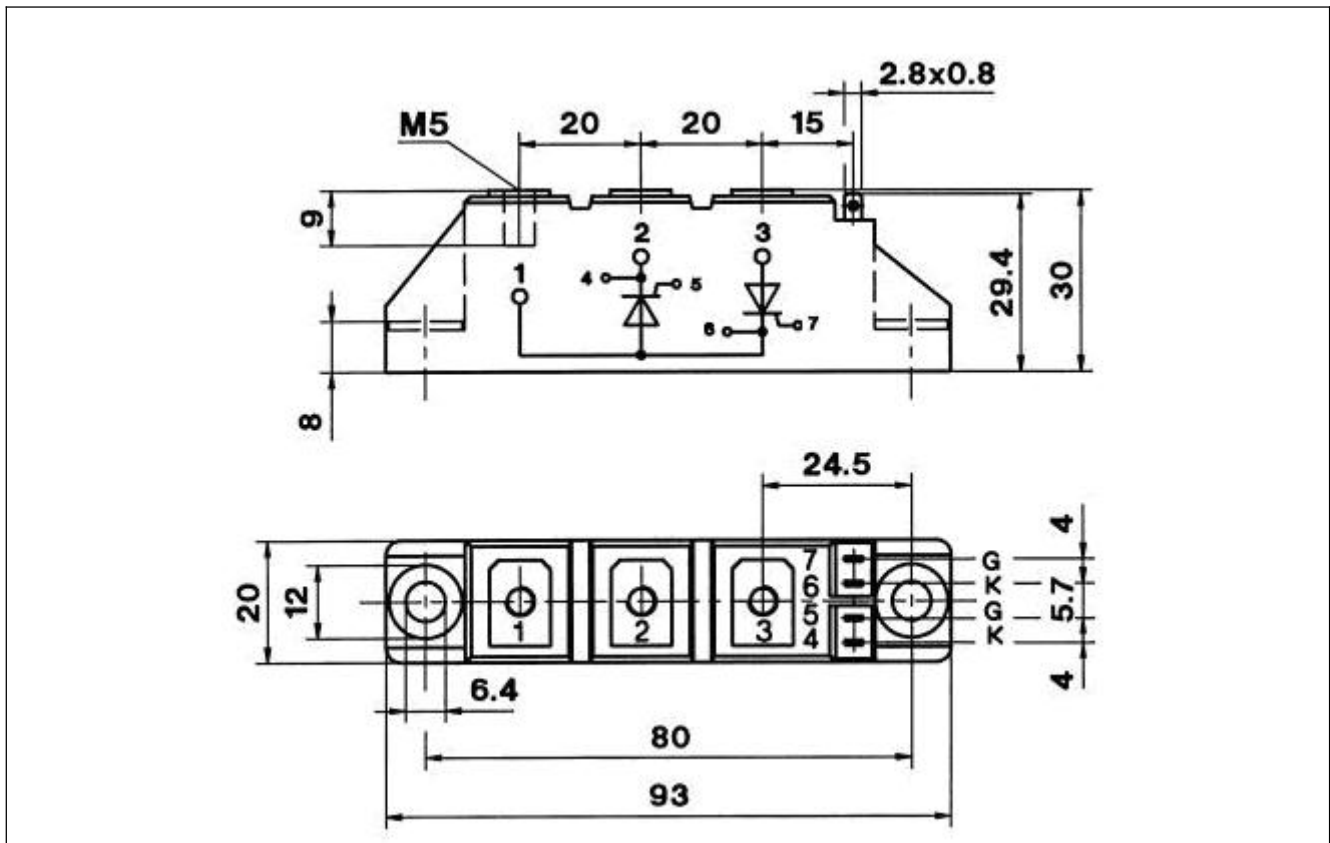

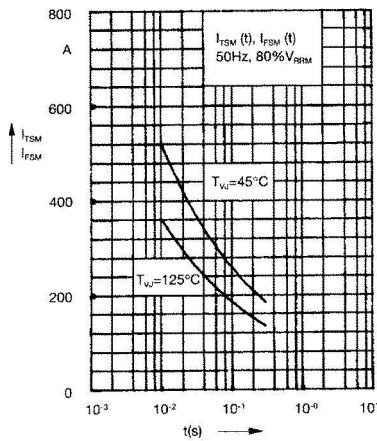

Fig. 1 Surge overload current

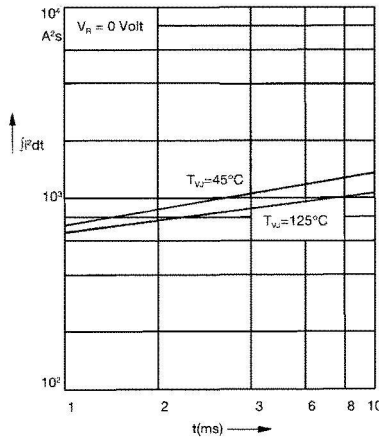

Fig. 2 i^2dt versus time (1-10 ms)

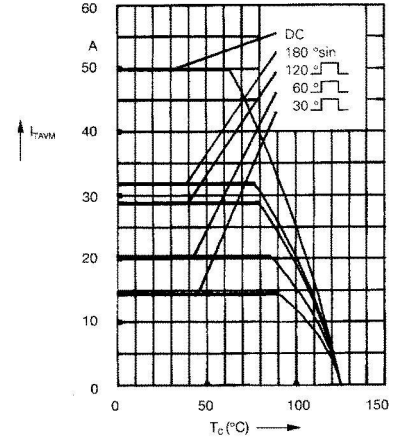

Fig. 2a Maximum forward current

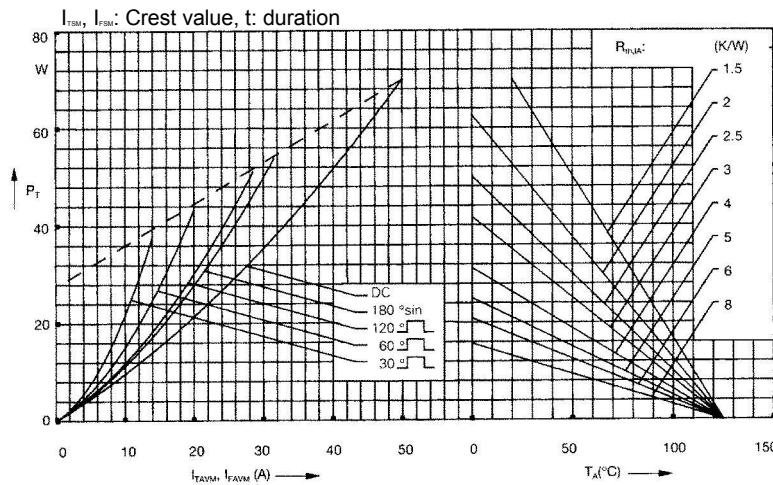

Fig. 3 Power dissipation versus on-state current and ambient temperature (per thyristor or diode)

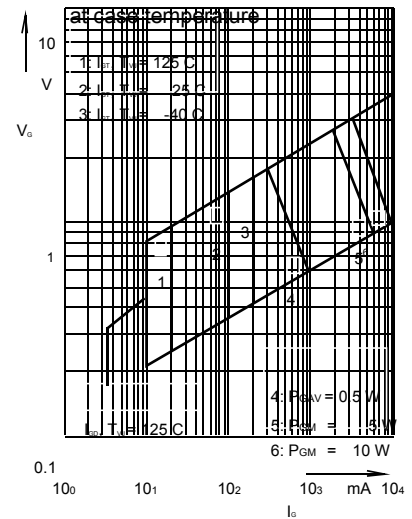

Fig. 4 Gate trigger characteristics

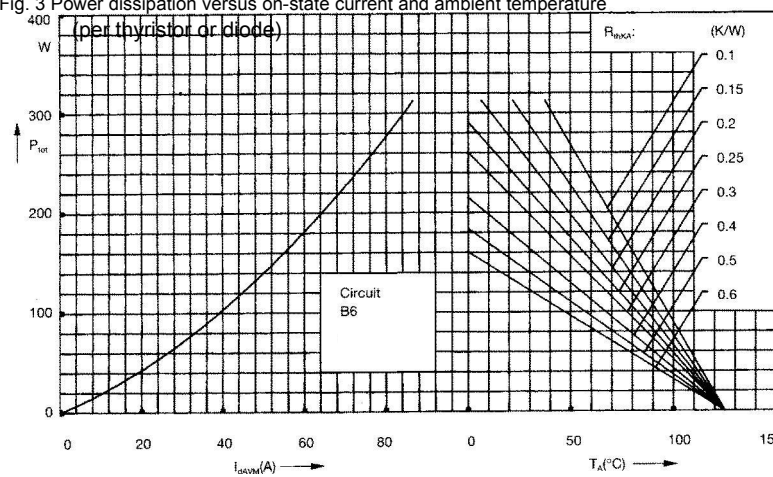

Fig. 5 Three phase rectifier bridge: Power dissipation versus direct output current and ambient temperature

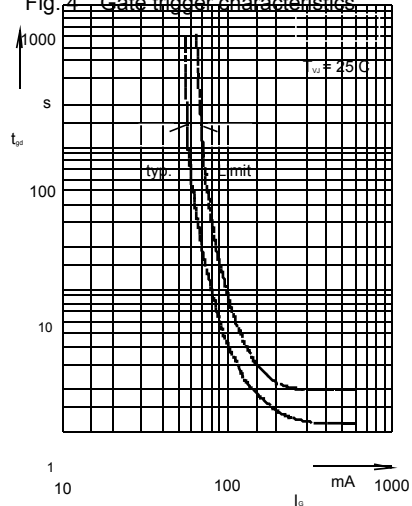

Fig. 6 Gate trigger delay time

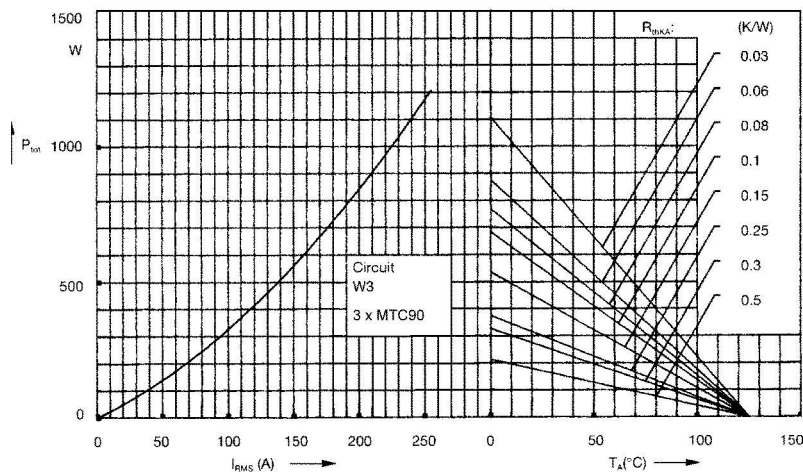

Fig. 7 Three phase AC-controller:
Power dissipation versus RMS
output current and ambient
temperature

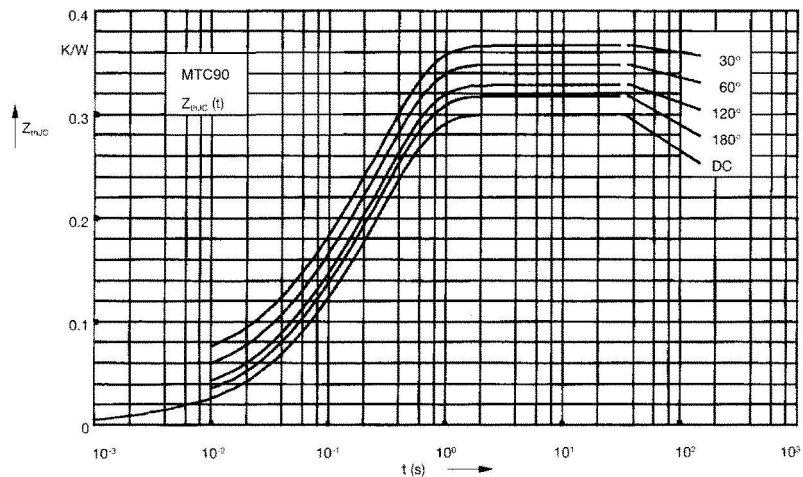

Fig. 8 Transient thermal impedance
junction to case (per thyristor or
diode)

$R_{\theta JC}$ for various conduction angles d:

d	$R_{\theta JC}$ (K/W)
DC	0.3
180°C	0.31
120°C	0.33
60°C	0.35
30°C	0.37

Constants for $Z_{\theta JC}$ calculation:

i	R_{ω} (K/W)	t (s)
1	0.008	0.019
2	0.054	0.047
3	0.238	0.3

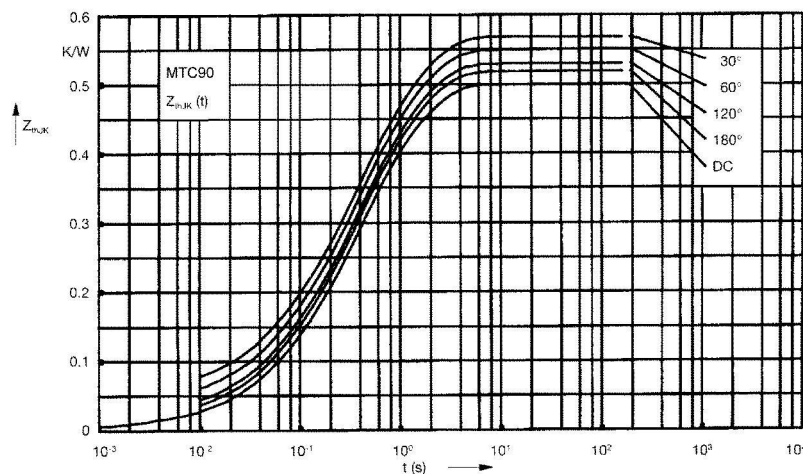

Fig. 9 Transient thermal impedance
junction to heatsink(per thyristor
or diode)

$R_{\theta JK}$ for various conduction angles d:

d	$R_{\theta JK}$ (K/W)
DC	0.5
180°C	0.51
120°C	0.53
60°C	0.55
30°C	0.57

Constants for $Z_{\theta JK}$ calculation:

i	R_{ω} (K/W)	t (s)
1	0.008	0.0019
2	0.054	0.0047
3	0.238	0.3
4	0.2	1.25