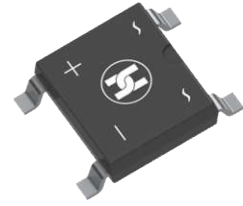
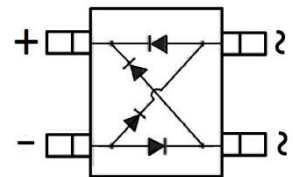

BRIDGE RECTIFIER
FEATURES

- Low reverse voltage leakage current
- Glass passivated die construction
- Low forward voltage drop
- High forward surge current capability
- Small surface mount device

ABS

MECHANICAL DATA

- Case: ABS
- Case Material: Molded Plastic. UL flammability
- Classification Rating: 94V-0
- Weight: 0.10 grams (approximate)
- Marking:ABS205-ABS210

MAXIMUM RATINGS ($T_A = 25^\circ\text{C}$ unless otherwise specified)

Parameter	Symbol	ABS	ABS	ABS	ABS	ABS	ABS	ABS	Unit
		205	21	22	24	26	28	210	
Repetitive peak reverse voltage	V_{RRM}	50	100	200	400	600	800	1000	V
DC Reverse Voltage	V_R	50	100	200	400	600	800	1000	V
RMS Reverse Voltage	V_{RMS}	35	70	140	280	420	560	700	V
Average forward rectified output current at $T_A=40^\circ\text{C}$	$I_{F(AV)}$	2.0							A
Peak forward surge current single sine-wave superimposed on rated load (JEDEC method)	I_{FSM}	50							A
Rating for fusing ($t < 8.3\text{ms}$)	I^2t	10							A^2s
Typical thermal resistance per element (note 1)	$R_{\theta JA}$	110							$^\circ\text{C}/\text{W}$
Typical junction capacitance per element (note 2)	C_j	25							pF
Operating junction and storage temperature range	T_J, T_{STG}	-55 ~ +150							$^\circ\text{C}$

ELECTRICAL CHARACTERISTICS ($T_A = 25^\circ\text{C}$ unless otherwise specified)

Parameter	Symbol	ABS	ABS	ABS	ABS	ABS	ABS	ABS	Unit	Conditions
		205	21	22	24	26	28	210		
Maximum instantaneous forward voltage drop per leg	V_F	1.1							V	$I_F=1\text{A}$
Maximum DC reverse current at rated	I_R	10							μA	$T_A = 25^\circ\text{C}$
DC blocking voltage per element		500								$T_A = 125^\circ\text{C}$

Notes:

1. Thermal resistance from Junction to ambient on P.C.board mounting;
2. Measured at 2.0MHz and applied reverse voltage of 4.0 volts;
3. Resistive or Inductive load, 60Hz;
4. For capacitive load derate by 20 %.

BRIDGE RECTIFIER

Typical Characteristics

Fig. 1 Derating Curve for Output Rectified Current

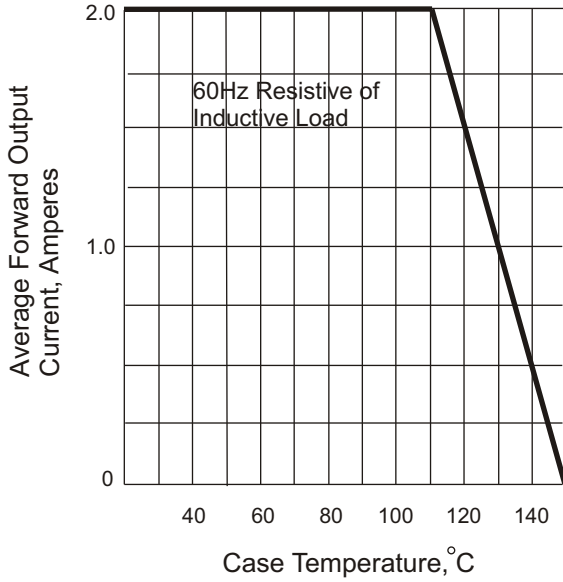

Fig. 2 Maximum Non-repetitive Peak Forward Surge Current

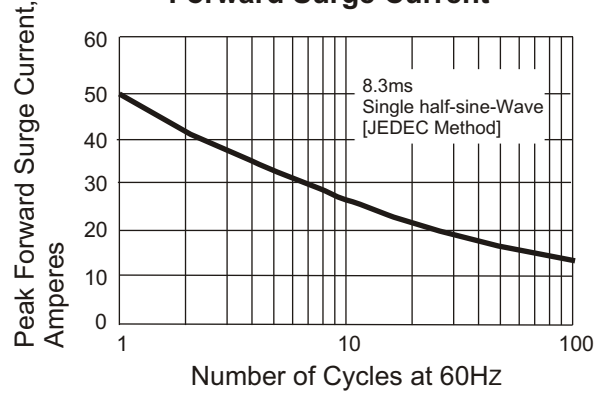

Fig. 3 Typical Instantaneous Forward Characteristics

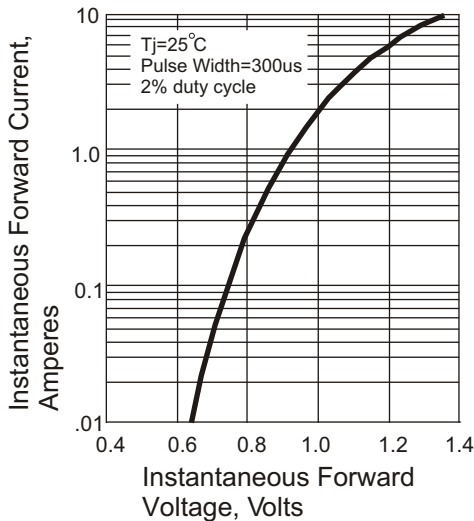

Fig. 4 Typical Revers Characteristics

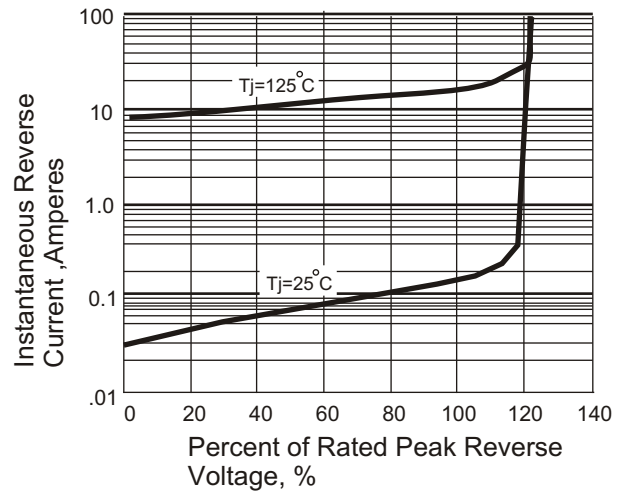
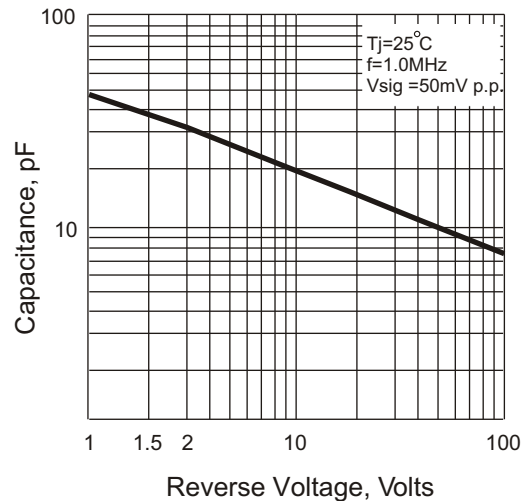
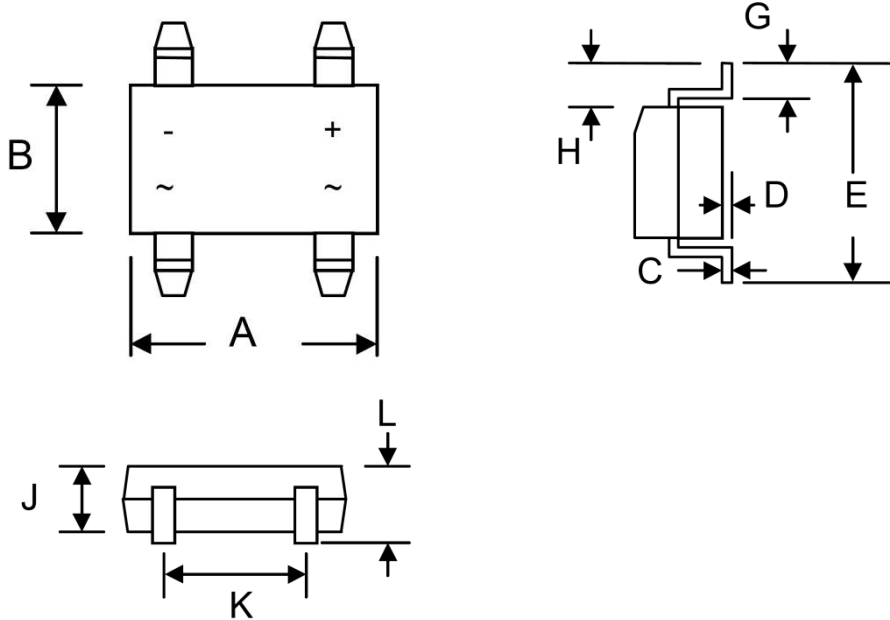

Fig. 5 Typical Junction Capacitance



BRIDGE RECTIFIER

ABS Package Outline Dimensions



Symbol	Dimensions In Millimeters		Dimensions In Inches	
	Min.	Max.	Min.	Max.
A	4.80	5.30	0.189	0.209
B	4.20	4.60	0.165	0.181
C	0.15	0.25	0.006	0.010
D	-----	0.20	—	0.008
E	6.00	6.80	0.236	0.268
G	0.30	0.70	0.012	0.028
H	0.90	1.10	0.035	0.043
J	—	1.50	—	0.059
K	3.80	4.20	0.150	0.165
L	1.22	1.72	0.048	0.068

ABS Suggested Pad Layout

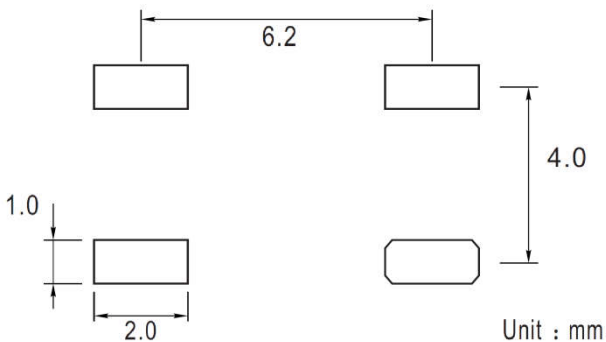

Note:

1. Controlling dimension: in millimeters
2. General tolerance: $\pm 0.05\text{mm}$
3. The pad layout is for reference purposes only

BRIDGE RECTIFIER

ABS Tape and Reel

ABS Embossed Carrier Tape

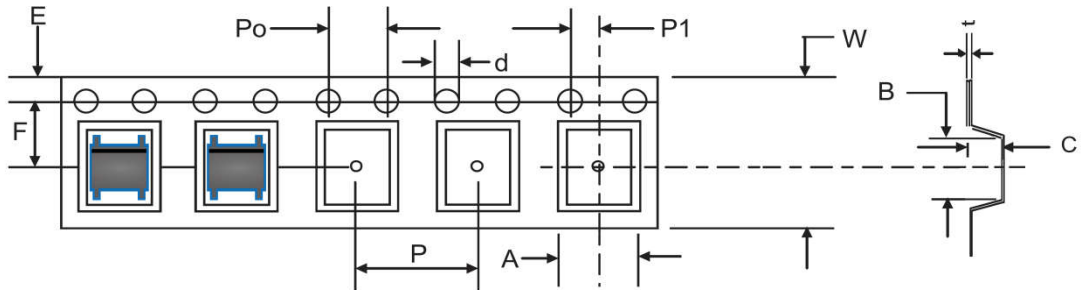

DIMENSIONS ARE IN MILLIMETER										
TYPE	A	B	C	d	E	F	P0	P	P1	W
ABS	5.31	6.68	1.85	Ø1.50	1.75	5.50	4.00	8.00	2.00	12.00
TOLERANCE	±0.1	±0.1	±0.1	±0.1	±0.1	±0.1	±0.1	±0.1	±0.1	±0.1

ABS Tape Leader and Trailer

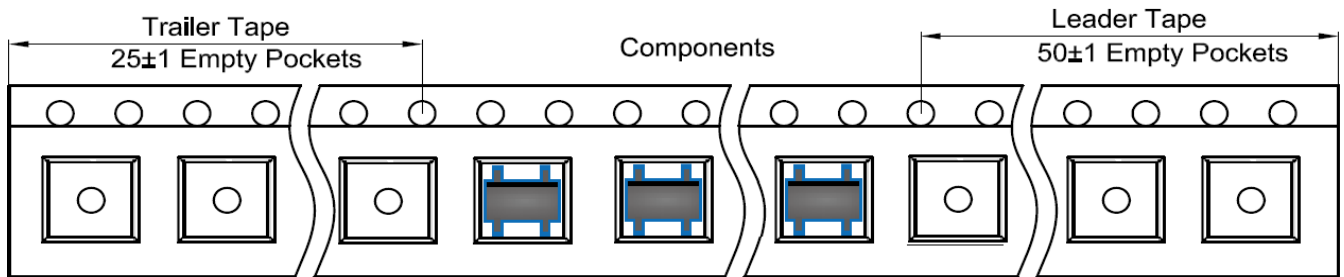

ABS Reel

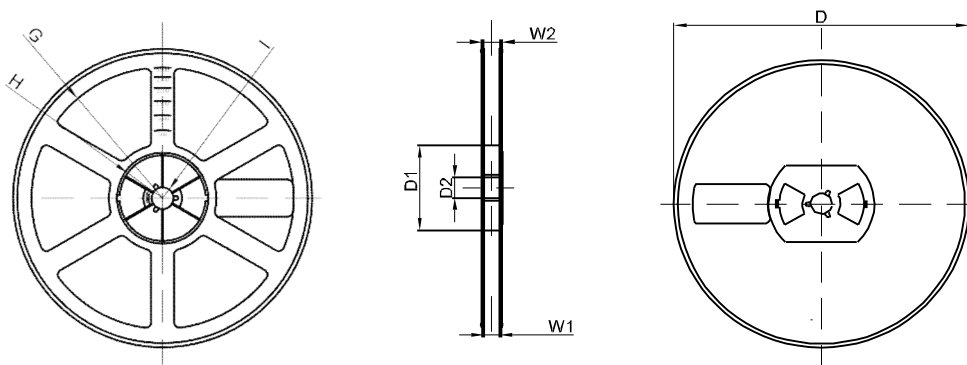

DIMENSIONS ARE IN MILLIMETER								
REEL OPTION	D	D1	D2	G	H	I	W1	W2
13" DIA	Ø330	75.0	13.00	R165	R37.50	R6.50	12.40	17.60
TOLERANCE	±2	±1	±1	±1	±1	±1	±1	±1