



High-Current, High-Speed OPERATIONAL AMPLIFIER

FEATURES

- 1.2A OUTPUT CURRENT
- 12Vp-p OUTPUT VOLTAGE
- WIDE POWER RANGE:
 - Single Supply: +7V to +15V
 - Dual Supply: $\pm 3.5V$ to $\pm 7.5V$
- FULLY PROTECTED:
 - Thermal Shutdown
 - Adjustable Current Limit
- OUTPUT DISABLE CONTROL
- 17MHz GAIN-BANDWIDTH PRODUCT
- 50V/ μs SLEW RATE
- 1MHz FULL-POWER BANDWIDTH
- THERMALLY ENHANCED HTSSOP-20 PowerPAD PACKAGE

APPLICATIONS

- POWER-LINE COMMUNICATIONS
- VALVE-ACTUATOR DRIVERS
- POWER SUPPLIES
- TEST EQUIPMENT
- TEC DRIVERS
- LASER DIODE DRIVERS

DESCRIPTION

The OPA561 is a low-cost, high-current operational amplifier capable of driving up to 1.2A pulses into reactive loads. This monolithic integrated circuit provides high reliability in demanding line-carrier communications, laser diode drivers, and motor control applications. The high slew rate provides 1MHz full-power bandwidth and excellent linearity.

The OPA561 operates from either a single supply in the range of 7V to 15V or dual power supplies of $\pm 3.5V$ to $\pm 7.5V$ for design flexibility. In single-supply operation, the input common-mode range extends below ground. At maximum output current, a wide output swing provides a 12Vp-p capability with a nominal 15V supply.

The OPA561 is internally protected against over-temperature conditions and current overloads. In addition, the OPA561 is designed to provide an accurate, user-selected, current limit. The current limit can be adjusted from 0.2A to 1.2A with a low-power resistor/potentiometer or DAC (Digital-to-Analog Converter). The high-speed characteristics of the current control loop provide accuracy even under pulsed load conditions.

The Enable/Status (E/S) pin performs two functions: it can be monitored to determine if the device is in thermal shutdown (active LOW), and it can also be forced LOW to disable the output, disconnecting the load.

The OPA561 is available in the miniature, HTSSOP-20 PowerPAD™ power package. This surface-mount package is thermally enhanced and has a very low thermal resistance. Operation is specified over the extended industrial temperature range, $-40^{\circ}C$ to $+125^{\circ}C$.

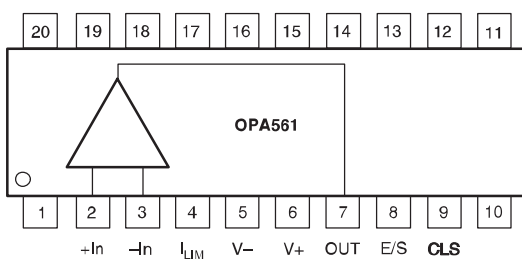

HTSSOP-20

NOTE: Pins 1, 10, and 11-20 are not connected.
PowerPAD must be connected to V-.



Please be aware that an important notice concerning availability, standard warranty, and use in critical applications of Texas Instruments semiconductor products and disclaimers thereto appears at the end of this data sheet.

PowerPAD is a trademark of Texas Instruments Incorporated. All other trademarks are the property of their respective owners.

ABSOLUTE MAXIMUM RATINGS(1)

Supply Voltage, V- to V+	16V
Input Voltage Range	(V-) - 0.4V to (V+) + 0.5V
Input Shutdown Voltage	(V-) - 0.4V to (V-) + 5.0V
Operating Temperature	-40°C to +125°C
Storage Temperature	-65°C to +150°C
Junction Temperature	150°C
Lead Temperature (soldering, 10s)	300°C

(1) Stresses above these ratings may cause permanent damage. Exposure to absolute maximum conditions for extended periods may degrade device reliability. These are stress ratings only, and functional operation of the device at these or any other conditions beyond those specified is not implied.



ELECTROSTATIC DISCHARGE SENSITIVITY

This integrated circuit can be damaged by ESD. Texas Instruments recommends that all integrated circuits be handled with appropriate precautions. Failure to observe proper handling and installation procedures can cause damage.

ESD damage can range from subtle performance degradation to complete device failure. Precision integrated circuits may be more susceptible to damage because very small parametric changes could cause the device not to meet its published specifications.

PACKAGE/ORDERING INFORMATION(1)

PRODUCT	PACKAGE-LEAD	PACKAGE DESIGNATOR	SPECIFIED TEMPERATURE RANGE	PACKAGE MARKING	ORDERING NUMBER	TRANSPORT MEDIA, QUANTITY
OPA561PWP	HTSSOP-20	PWP	-40°C to +125°C	OPA561	OPA561PWP OPA561PWP/2K	Rails, 70 Tape and Reel, 2000

(1) For the most current package and ordering information, see the Package Option Addendum located at the end of this data sheet.

ELECTRICAL CHARACTERISTICS

BOLDFACE limits apply over the specified temperature range, $T_A = -40^\circ\text{C}$ to $+125^\circ\text{C}$.

At $T_{CASE} = +25^\circ\text{C}$, $V_S = 15\text{V}$, load connected to $V_S/2$, and E/S enabled, unless otherwise noted.

PARAMETER	CONDITIONS	OPA561			UNITS
		MIN	TYP	MAX	
OFFSET VOLTAGE					
Input Offset Voltage	$V_S = 12\text{V}$ $V_{CM} = 0\text{V}$		± 1	± 20	mV
vs Temperature	dV_{OS}/dT		± 50		$\mu\text{V}/^\circ\text{C}$
vs Power Supply	PSRR $V_{CM} = 0\text{V}$, $V_S = 7\text{V}$ to 16V		25	150	$\mu\text{V}/\text{V}$
INPUT BIAS CURRENT(1)					
Input Bias Current	$V_{CM} = 0\text{V}$		10	100	pA
Input Offset Current	$V_{CM} = 0\text{V}$		10	100	pA
NOISE					
Input Voltage Noise Density	e_n $f = 1\text{kHz}$ $f = 10\text{kHz}$ $f = 100\text{kHz}$		83 32 14		$\text{nV}/\sqrt{\text{Hz}}$ $\text{nV}/\sqrt{\text{Hz}}$ $\text{nV}/\sqrt{\text{Hz}}$
Current Noise	i_n $f = 1\text{kHz}$		4		$\text{fA}/\sqrt{\text{Hz}}$
INPUT VOLTAGE RANGE					
Common-Mode Voltage Range	Linear Operation	$(V-) - 0.1$		$(V+) - 3$	V
Common-Mode Rejection Ratio	$V_S = 15\text{V}$, $V_{CM} = (V-) - 0.1\text{V}$ to $(V+) - 3\text{V}$	70	80		dB
INPUT IMPEDANCE					
Differential			$1.8 \cdot 10^{11} \parallel 10$		$\Omega \parallel \text{pF}$
Common-Mode			$1.8 \cdot 10^{11} \parallel 18.5$		$\Omega \parallel \text{pF}$
OPEN-LOOP GAIN					
Open-Loop Voltage Gain	$V_O = 10\text{Vp-p}$, $R_L = 5\Omega$	80	100		dB
FREQUENCY RESPONSE					
Gain-Bandwidth Product	GBW $R_L = 5\Omega$		17		MHz
Slew Rate	SR $G = 1$, 10V Step , $R_L = 5\Omega$		50		$\text{V}/\mu\text{s}$
Full-Power Bandwidth	$G = +2$, $V_{OUT} = 10\text{Vp-p}$		1		MHz
Settling Time: $\pm 0.1\%$	$G = -1$, 10V Step		1		μs
Total Harmonic Distortion + Noise	THD+N $f = 1\text{kHz}$, $R_L = 5\Omega$, $G = +2$, $V_O = 10\text{Vp-p}$ $f = 1\text{MHz}$		0.02		%
			3		%

(1) High-speed test at $T_J = +25^\circ\text{C}$.

(2) See text for more information on current limit accuracy.

(3) Transient load transition time must be $\geq 200\text{ns}$.

(4) $402\text{k}\Omega$ pull-up resistor to $V+$ can be used to permanently enable the OPA561.

ELECTRICAL CHARACTERISTICS (continued)
BOLDFACE limits apply over the specified temperature range, $T_A = -40^{\circ}\text{C}$ to $+125^{\circ}\text{C}$.

 At $T_{\text{CASE}} = +25^{\circ}\text{C}$, $V_S = 15\text{V}$, load connected to $V_S/2$, and E/S enabled, unless otherwise noted.

PARAMETER	CONDITIONS	OPA561			UNITS
		MIN	TYP	MAX	
OUTPUT					
Voltage Output, Positive	$I_O = 0.5\text{A}$	$(V+) - 1$	$(V+) - 0.7$		V
Negative	$I_O = -0.5\text{A}$	$(V-) + 1$	$(V-) + 0.7$		V
Positive	$I_O = 1\text{A}$	$(V+) - 1.5$	$(V+) - 1.2$		V
Negative	$I_O = -1\text{A}$	$(V-) + 1.5$	$(V-) + 1.2$		V
Maximum Continuous Current Output, dc			1.2		A
Output Impedance Z_O	$G = +2, f = 100\text{kHz}$		0.05		Ω
Output Current Limit Range			± 0.2 to ± 1.2		A
Current Limit Tolerance ⁽²⁾	$R_{\text{CL}} = 2\text{k}\Omega$ ($I_{\text{LIM}} = \pm 1\text{A}$)		± 50		mA
Asymmetry	Comparing Positive and Negative Limits		10		%
Current Limit Overshoot ⁽³⁾	$V = 5\text{V}$ Pulse (200ns t_r), $G = +2$		50		%
Output Disabled					
Output Resistance			10		M Ω
Output Capacitance			140		pF
OUTPUT ENABLE/STATUS AND FLAG PINS					
Shutdown Input Mode					
$V_{\text{E/S}}$ HIGH (output enabled) ⁽⁴⁾	E/S Pin Open or Forced HIGH	$(V-) + 2$		$(V-) + 5$	V
$V_{\text{E/S}}$ LOW (output disabled)	E/S Pin Forced LOW	$(V-) - 0.4$		$(V-) + 0.8$	V
$I_{\text{E/S}}$ HIGH (output enabled)	E/S Pin Indicates HIGH		20		μA
$I_{\text{E/S}}$ LOW (output disabled)	E/S Pin Indicates LOW		0.1		μA
Output Disable Time			50		ns
Output Enable Time			3		μs
Thermal Shutdown Status					
Normal Operation	Sourcing $20\mu\text{A}$	$(V-) + 2$			V
Thermally Shutdown				$(V-) + 0.8$	V
Current Limit Status					
Normal Operation	Sourcing $20\mu\text{A}$	$(V-) + 0.8$			V
Current Limit Flagged				$(V-) + 2$	V
Junction Temperature at Shutdown			+160		$^{\circ}\text{C}$
Reset Temperature from Shutdown			+140		$^{\circ}\text{C}$
POWER SUPPLY					
Specified Voltage V_S			15		V
Operating Voltage Range, $(V+) - (V-)$		7		16	V
Quiescent Current I_Q	I_{LIM} Connected to $V-$, $I_Q = 0$		50	60	mA
Quiescent Current vs Temperature			60	70	mA
Quiescent Current in Shutdown Mode	I_{LIM} Connected to $V-$			250	μA
TEMPERATURE RANGE					
Specified Junction Temperature Range		-40		+125	$^{\circ}\text{C}$
Storage Range		-65		+150	$^{\circ}\text{C}$
Thermal Resistance					
HTSSOP-20 PowerPAD θ_{JC}			1.4		$^{\circ}\text{C}/\text{W}$
θ_{JA}	2oz. Trace and 9in ² Copper Pad with Solder		32		$^{\circ}\text{C}/\text{W}$
θ_{JA}	Without Heatsink		100		$^{\circ}\text{C}/\text{W}$

 (1) High-speed test at $T_J = +25^{\circ}\text{C}$.

(2) See text for more information on current limit accuracy.

 (3) Transient load transition time must be $\geq 200\text{ns}$.

 (4) $402\text{k}\Omega$ pull-up resistor to $V+$ can be used to permanently enable the OPA561.

TYPICAL CHARACTERISTICS

At $T_{CASE} = +25^{\circ}C$, $V_S = 15V$, and E/S enabled, unless otherwise noted.

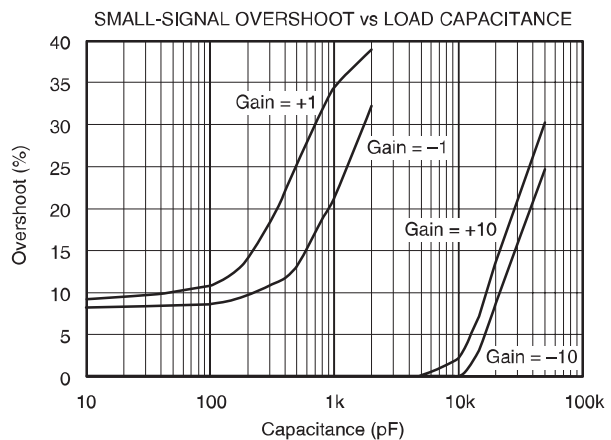
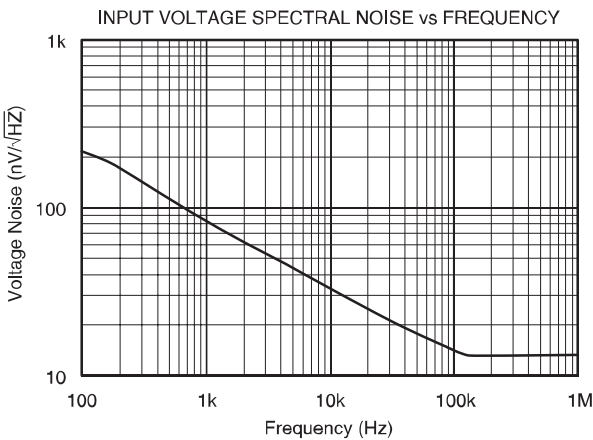
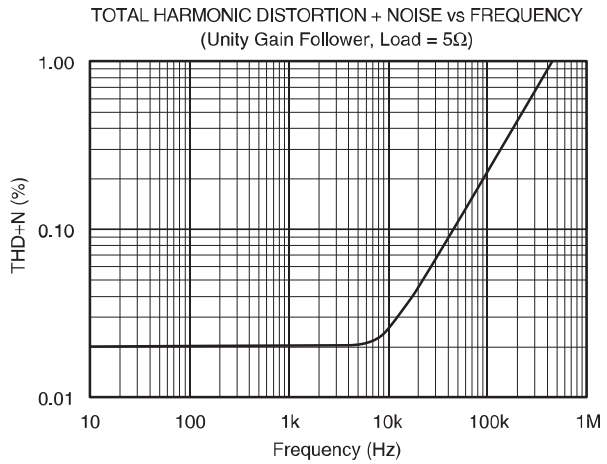
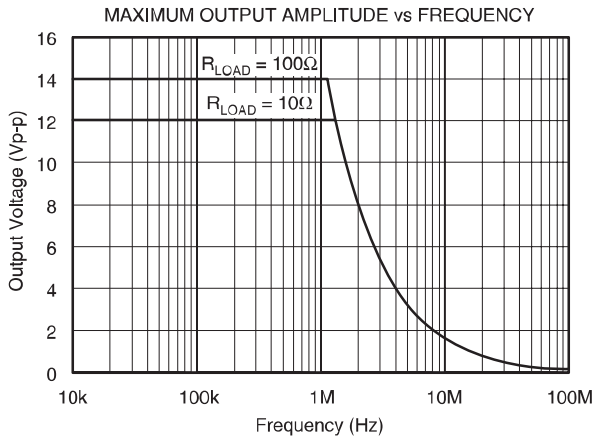
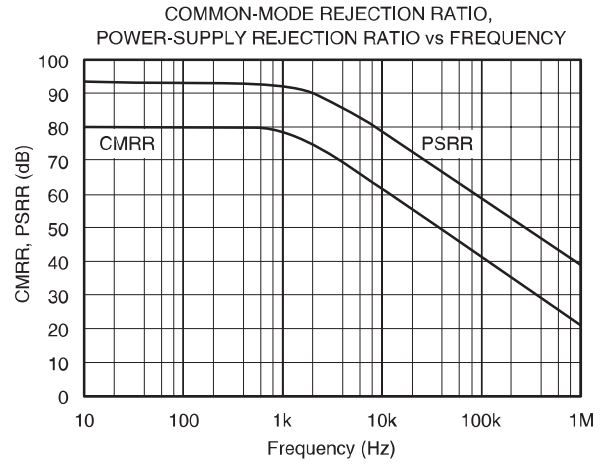
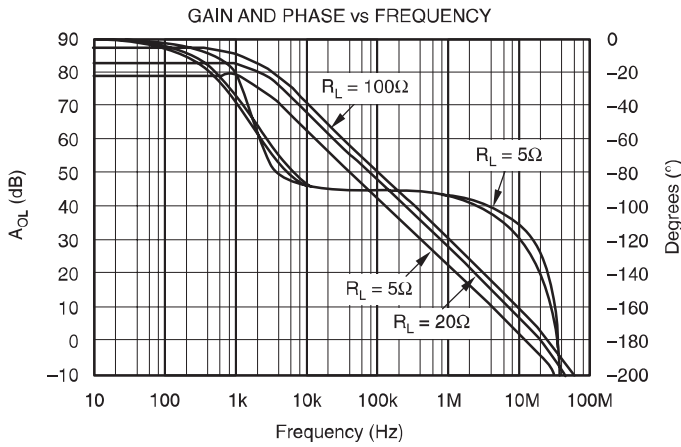

TYPICAL CHARACTERISTICS (continued)

At $T_{CASE} = +25^{\circ}C$, $V_S = 15V$, and E/S enabled, unless otherwise noted.

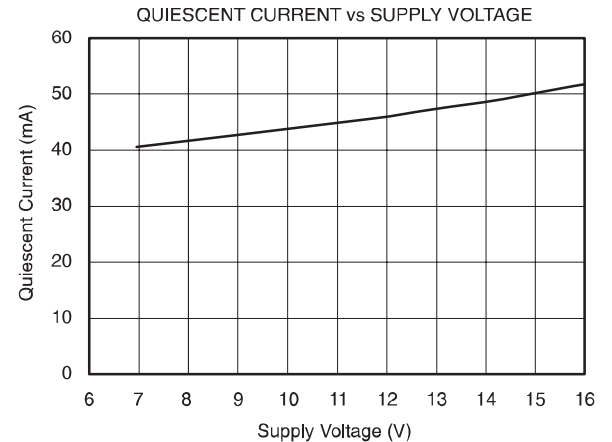
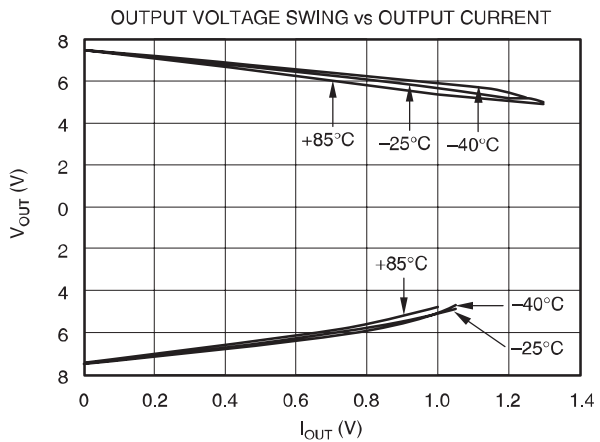
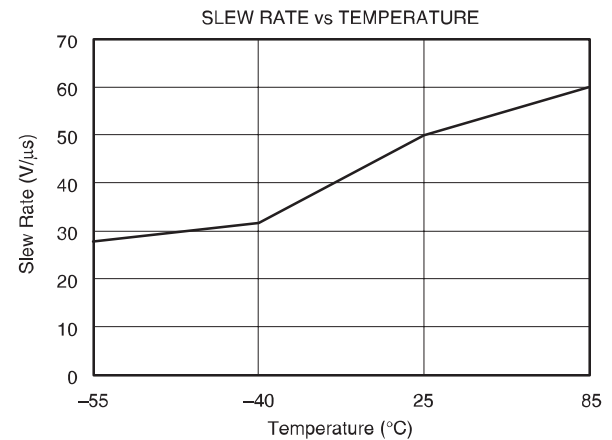
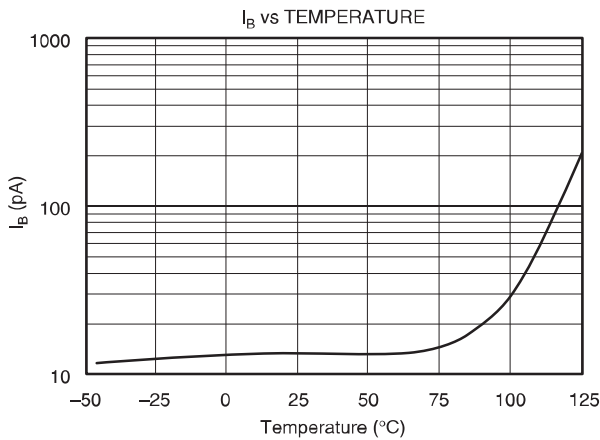
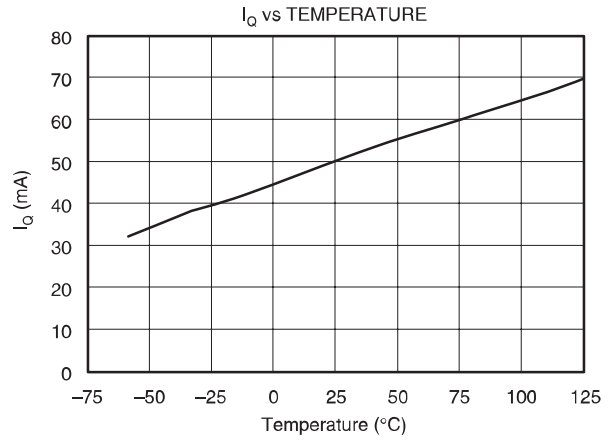
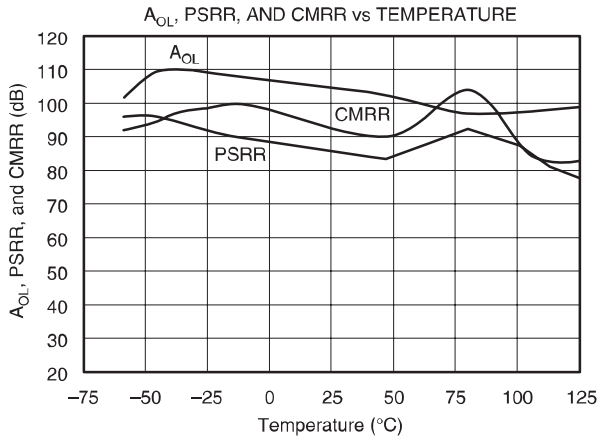

TYPICAL CHARACTERISTICS (continued)

At $T_{CASE} = +25^{\circ}C$, $V_S = 15V$, and enabled, unless otherwise noted.

SMALL-SIGNAL STEP RESPONSE

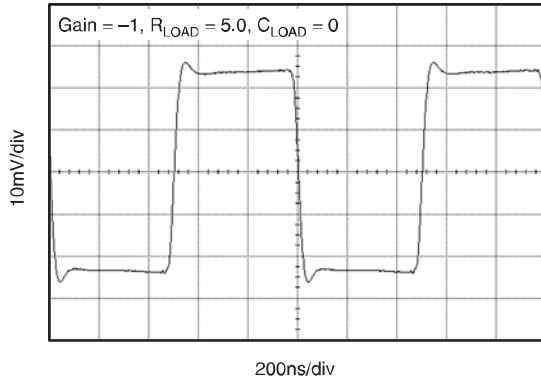

LARGE-SIGNAL STEP RESPONSE

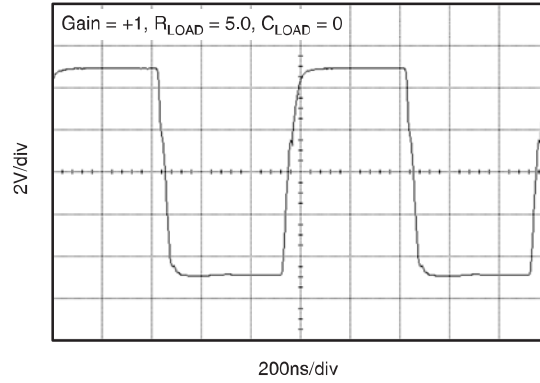

SHUTDOWN RESPONSE

$R_L = 5\Omega$

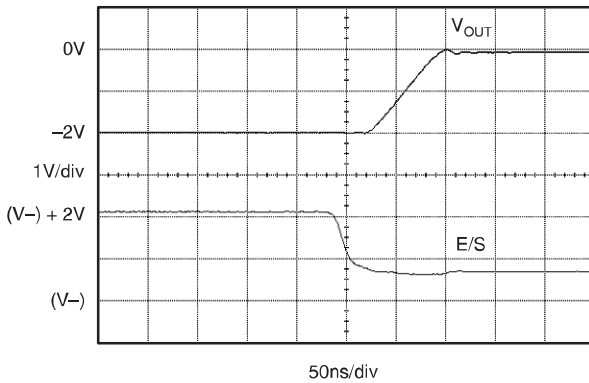

ENABLE RESPONSE

$R_L = 5\Omega$

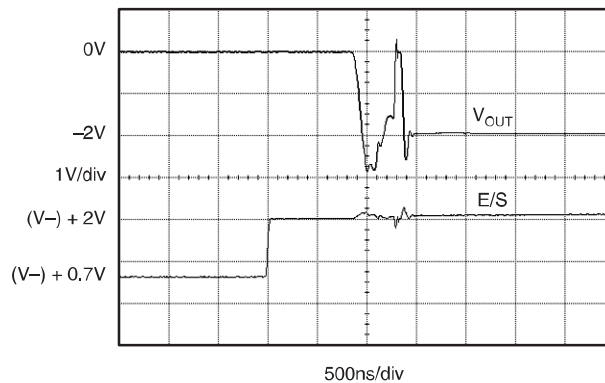

OFFSET VOLTAGE PRODUCTION DISTRIBUTION

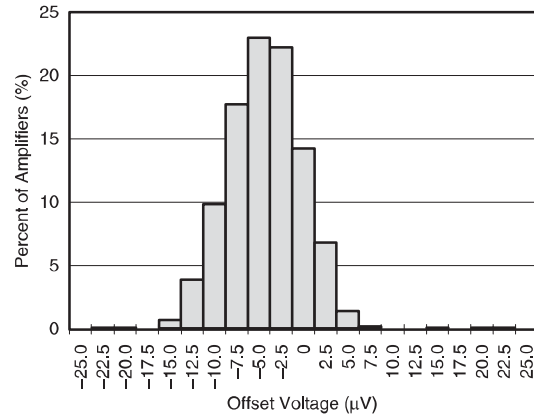

APPLICATIONS INFORMATION

Figure 1 shows the OPA561 connected as a basic noninverting amplifier. However, the OPA561 can be used in virtually any op amp configuration.

Power-supply terminals should be bypassed with low series impedance capacitors. The technique of using a ceramic and tantalum type in parallel is recommended. Power-supply wiring should have low series impedance.

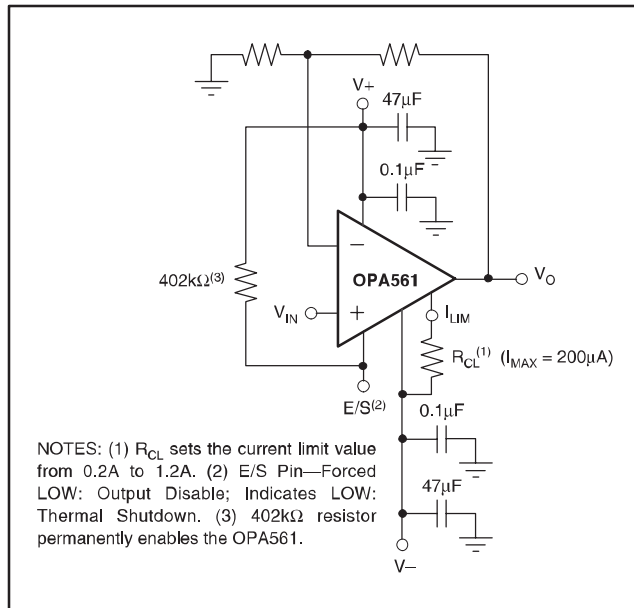

Figure 1. Basic Circuit Connections

POWER SUPPLIES

The OPA561 operates from single (+7V to +15V) or dual ($\pm 3.5V$ to $\pm 7.5V$) supplies with excellent performance. Power-supply voltages do not need to be equal. For example, the positive supply could be set to 10V with the negative supply at $-5V$, or vice-versa. Most behaviors remain unchanged throughout the operating voltage range. Parameters that vary significantly with operating voltage are shown in the typical characteristics.

ADJUSTABLE CURRENT LIMIT

The OPA561's accurate, user-defined, current limit can be set from 0.2A to 1.2A by controlling the input to the I_{LIM} pin. Unlike other designs that use a power resistor in series with the output current path, the OPA561 senses the load internally. This allows the current limit to be set with low-power components. In contrast, other designs require one or two expensive power resistors that can handle the full output current (1.2A in this case).

Current Limit Accuracy

Separate circuits monitor the positive and negative currents. Each output is compared to a single internal reference that is set by the external current limit resistor (or

voltage). The OPA561 employs a patented circuit technique to achieve an accurate and stable current limit. The output current limit has an accuracy of up to 5% on the 1A current limit. Due to internal matching limitations, the positive and negative current limits can be slightly different. However, the values are typically within 10% of each other.

Setting the Current Limit

Leaving the I_{LIM} pin open could damage the part. Connecting I_{LIM} directly to $V-$ programs the maximum output current limit, typically 1.2A. The simplest method for adjusting the current limit (I_{LIM}) uses a resistor or potentiometer connected between the I_{LIM} pin and $V-$ according to Equation 1:

$$I_{LIM} = \left(\frac{1.2V}{R_{CL} + 10k\Omega} \right) \times 1000 \quad (1)$$

This external resistor determines a small internal current which sets the desired output current limit. Alternatively, the output current limit can be set by applying a voltage to the I_{LIM} pin. Figure 2 shows a simplified schematic of the OPA561's current limit.

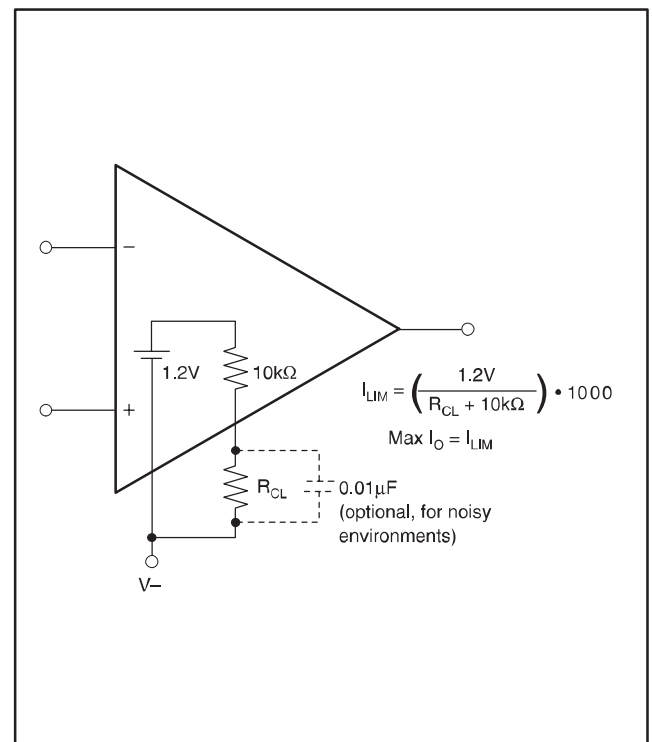

Figure 2. Adjustable Current Limit—Resistor Method

ENABLE/STATUS (E/S) PIN

The Enable/Status Pin provides two unique functions: 1) output disable by forcing the pin LOW and 2) thermal shutdown indication by monitoring the voltage level at the pin. One or both of these functions can be utilized on the same device. For normal operation (output enabled), the E/S pin must be pulled HIGH (at least 2V above V_-). A small value capacitor connected between the E/S pin and V_- may be appropriate for noisy applications. To enable the OPA561 permanently, the E/S pin can be tied to V_+ through a 402k Ω pull-up resistor.

Output Disable

The shutdown pin is referenced to the negative supply (V_-). Therefore, shutdown operation is slightly different in single-supply and dual-supply applications.

In single-supply operation, V_- typically equals common ground. Therefore, the shutdown logic signal and the OPA561's shutdown pin are referenced to the same potential. In this configuration, the logic pin and the OPA561 enable can simply be tied together. Shutdown occurs for voltage levels of $< 0.8V$. The OPA561 is enabled at logic levels $> 2V$.

In dual-supply operation, the logic pin is still referenced to a logic ground. However, the shutdown pin of the OPA561 is still referenced to V_- . To shutdown the OPA561, the voltage level of the logic signal needs to be level shifted using an optocoupler, as shown in Figure 3.

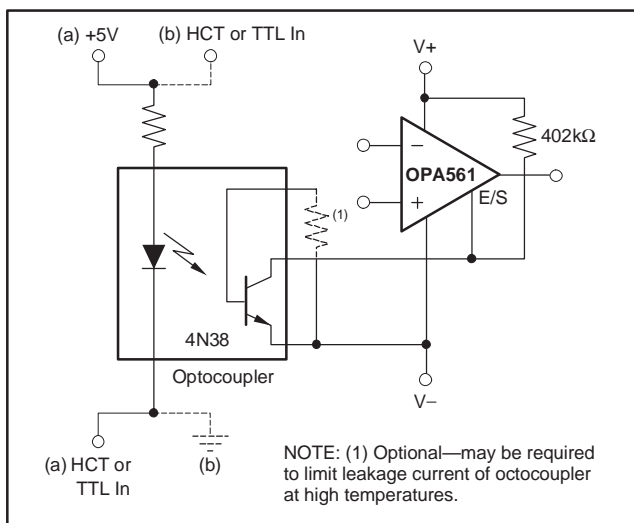

Figure 3. Shutdown Configuration for Dual Supplies

To disable the output, the E/S pin is pulled LOW, no greater than 0.8V above V_- . This function can be used to conserve power during idle periods. The typical time required to shut

down the output is 50ns. To return the output to an enabled state, the E/S pin should be pulled to at least 2.0V above V_- . Typically, the output is enabled within 3 μ s. It should be noted that pulling the E/S pin HIGH (output enabled) does not disable the internal thermal shutdown.

Ensuring Microcontroller Compatibility

Not all microcontrollers output the same logic state after power-up or reset. 8051-type microcontrollers, for example, output logic HIGH levels on their ports while other models power up with logic LOW levels after reset.

In configuration (a) as shown in Figure 3, the shutdown signal is applied on the cathode side of the photodiode within the optocoupler. A high logic level causes the OPA561 to be enabled, and a low logic level shuts the OPA561 down. In configuration (b) of Figure 3, with the logic signal applied on the anode side, a high level causes the OPA561 to shutdown and low level enables the op amp.

OVER-CURRENT FLAG

The OPA561 features an over-current status flag (CLS, Pin 9) that can be monitored to see if the load exceeds the current limit. The output signal of the over current limit flag is compatible to standard logic. The CLS signal is referenced to V_- . A voltage level of less than $(V_-) + 0.8V$ indicates normal operation and a level of greater than $(V_-) + 2$ indicates that the OPA561 is in current limit. The flag is HIGH as long as the output of the OPA561 is in current limit. At very low signal frequencies, typically $< 1kHz$, both the upper (sourcing current) and lower current limit (sinking current) are monitored. At frequencies $> 1kHz$, due to internal circuit limitations, the flag output signal for the upper current limit becomes delayed and shortened. The flag signal for the lower current limit is unaffected by this behavior. As the signal frequency increases further, only the lower current limit (sinking current) is output on pin 9.

OUTPUT STAGE COMPENSATION

The complex load impedances common in power op amp applications can cause output stage instability. For normal operation, output compensation circuitry is typically not required. However, if the OPA561 is intended to be driven into current limit, an R/C network (snubber) may be required. A snubber circuit may also enhance stability when driving large capacitive loads ($> 1000pF$) or inductive loads (motors, loads separated from the amplifier by long cables). Typically, 3 Ω to 10 Ω in series with 0.01 μ F to 0.1 μ F is adequate. Some variations in circuit value may be required with certain loads.

OUTPUT PROTECTION

Reactive and EMF-generation loads can return load current to the amplifier, causing the output voltage to exceed the power-supply voltage. This damaging condition can be avoided with clamp diodes from the output terminal to the power supplies, as shown in Figure 4. Schottky rectifier diodes with a 3A or greater continuous rating are recommended.

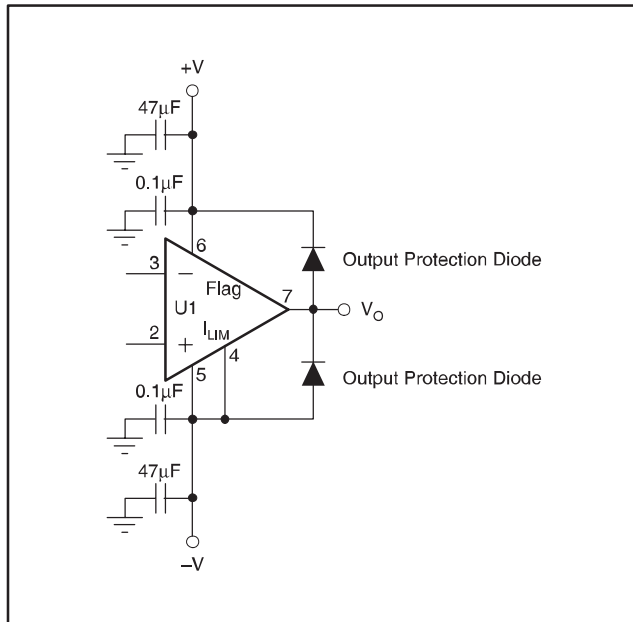

Figure 4. Output Protection Diode

THERMAL PROTECTION

The OPA561 has thermal sensing circuitry that helps protect the amplifier from exceeding temperature limits. Power dissipated in the OPA561 will cause the junction temperature to rise. Internal thermal shutdown circuitry shuts down the output when the die temperature reaches approximately 160°C, resetting when the die has cooled to 140°C. Depending on load and signal conditions, the thermal protection circuit may cycle on and off. This limits the dissipation of the amplifier, but may have an undesirable effect on the load. Any tendency to activate the thermal protection circuit indicates excessive power dissipation or an inadequate heatsink. For reliable, long-term, continuous operation, junction temperature should be limited to +125°C, maximum. To estimate the margin of safety in a complete design (including heatsink), increase the ambient temperature until the thermal protection is triggered. Use worst-case loading and signal conditions. For good, long-term reliability, thermal protection should trigger more than 35°C above the

maximum expected ambient condition of your application. This produces a junction temperature of +125°C at the maximum expected ambient condition.

The internal protection circuitry of the OPA561 was designed to protect against overload conditions; it was not intended to replace proper heatsinking. Continuously running the OPA561 into thermal shutdown can degrade reliability. The E/S pin can be monitored to determine if shutdown has occurred. During normal operation the voltage on the E/S pin is typically above (V-) + 2V. During shutdown, the voltage drops to less than (V-) + 0.8V.

POWER DISSIPATION

Power dissipation depends on power supply, signal, and load conditions. For DC signals, power dissipation is equal to the product of output current times the voltage across the conducting output transistor. Dissipation with ac signals is lower. Application Bulletin AB-039 (SBOA022) explains how to calculate or measure power dissipation with unusual signals and loads, and can be downloaded from www.ti.com.

HEATSINK AREA

The relationship between thermal resistance and power dissipation can be expressed as:

where:

$$T_J = \text{Junction Temperature } (^\circ\text{C})$$

$$T_A = \text{Ambient Temperature } (^\circ\text{C})$$

$$\theta_{JA} = \text{Junction-to-Ambient Thermal Resistance } (^\circ\text{C/W})$$

$$P_D = \text{Power Dissipation (W)}$$

To appropriately determine required heatsink area, required power dissipation should be calculated and the relationship between power dissipation and thermal resistance should be considered to minimize shutdown conditions and allow for proper long-term operation (junction temperature of +125°C). Once the heatsink area has been selected, worst-case load conditions should be tested to ensure proper thermal protection.

For applications with limited board size, refer to Figure 5 for the approximate thermal resistance relative to heatsink area. Increasing heatsink area beyond 2in² provides little improvement in thermal resistance. To achieve the 32°C/W stated in the Electrical Characteristics, a copper plane size of 9in² was used. The HTSSOP-20 PowerPAD package is well suited for continuous power levels from 2W to 4W, depending on ambient temperature and heatsink area. Higher power levels may be achieved in applications with a low on/off duty cycle, such as remote meter reading.

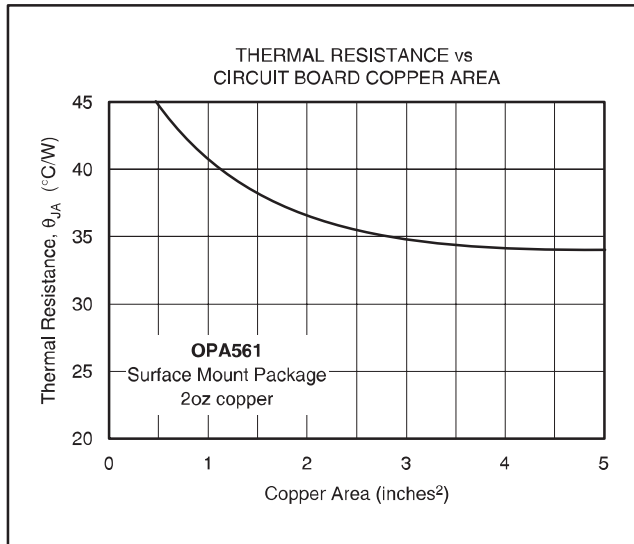

Figure 5. Thermal Resistance vs Circuit Board Copper Area

AMPLIFIER MOUNTING

What is PowerPAD?

The OPA561 uses the HTSSOP-20 PowerPAD package, a thermally enhanced, standard size IC package designed to eliminate the use of bulky heatsinks and slugs traditionally used in thermal packages. This package can be easily mounted using standard PCB assembly techniques, and can be removed and replaced using standard repair procedures.

The PowerPAD package is designed so that the leadframe die pad (or thermal pad) is exposed on the bottom of the IC, as shown in Figure 6. This provides an extremely low thermal resistance (θ_{JC}) path between the die and the exterior of the package. The thermal pad on the bottom of the IC must be soldered directly to the PCB, using the PCB as a heatsink. In addition, through the use of thermal vias, the thermal pad can be directly connected to a ground plane or special heatsink structure designed into the PCB.

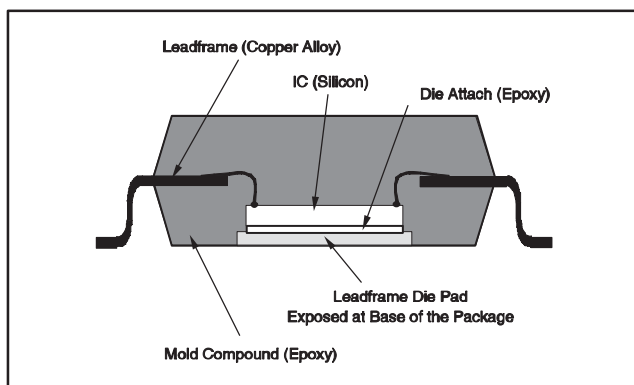

Figure 6. Section View of a PowerPAD Package

Soldering the PowerPAD to the PCB is always recommended, even with applications that have low power dissipation. It provides the necessary connection between the leadframe die and the PCB. The PowerPAD should be connected to the most negative supply of the device.

PowerPAD Assembly Process

1. Prepare the PCB with a top side etch pattern, as shown in Figure 7. There should be etch for the leads as well as etch for the thermal land.
2. Place the recommended number of holes (or thermal vias) in the area of the thermal pad. These holes should be 13 mils in diameter. They are kept small so that solder wicking through the holes is not a problem during reflow. The recommended number of holes for the HTSSOP-20 PowerPAD package is eight, as shown in Figure 7.
3. It is recommended, but not required, to place a small number of the holes under the package and outside the thermal pad area. These holes provide additional heat path between the copper land and ground plane and are 25 mils in diameter. They may be larger because they are not in the area to be soldered, so wicking is not a problem. This is illustrated in Figure 7.

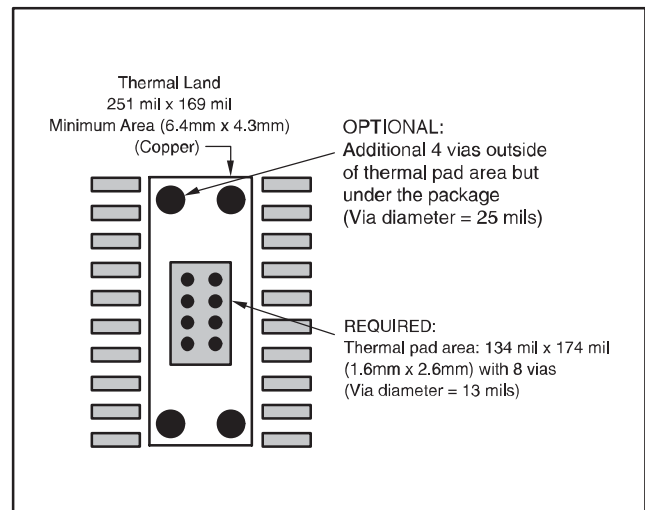

Figure 7. PWP-20 PowerPAD PCB Etch and Via Pattern

4. Connect all holes, including those within the thermal pad area and outside the pad area, to the internal ground plane or other internal copper plane.
5. When connecting these holes to the ground plane, do not use the typical web or spoke via connection methodology, see Figure 8. Web connections have a high thermal resistance connection that is useful for slowing the heat transfer during soldering operations. This makes the soldering of vias that have plane connections easier. However, in this application, low thermal resistance is desired for the most efficient heat transfer. Therefore, the holes under the

PowerPAD package should make their connection to the internal ground plane with a complete connection around the entire circumference of the plated through hole.

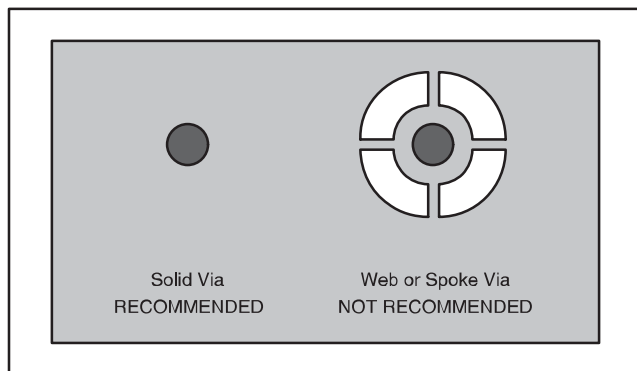

Figure 8. Via Connection

6. The top-side solder mask should leave exposed the terminals of the package and the thermal pad area. The thermal pad area should leave the 13 mil holes exposed. The larger 25 mil holes outside the thermal pad area should be covered with solder mask.
7. Apply solder paste to the exposed thermal pad area and all of the package terminals.
8. With these preparatory steps in place, the PowerPAD IC is simply placed in position and run through the solder reflow operation as any standard surface-mount component. This results in a part that is properly installed.

For detailed information on the PowerPAD package including thermal modeling considerations and repair procedures, please see Technical Brief SLMA002, *PowerPAD Thermally Enhanced Package*, available at www.ti.com.

LAYOUT GUIDELINES

The OPA561 is a high-speed power amplifier that requires proper layout for best performance. Figure 9 shows an example of proper layout.

Keep power-supply leads as short as possible. This will keep inductance low and resistive losses at a minimum. A minimum 18 gauge wire thickness is recommended for power-supply leads. The wire length should be < 8 inches.

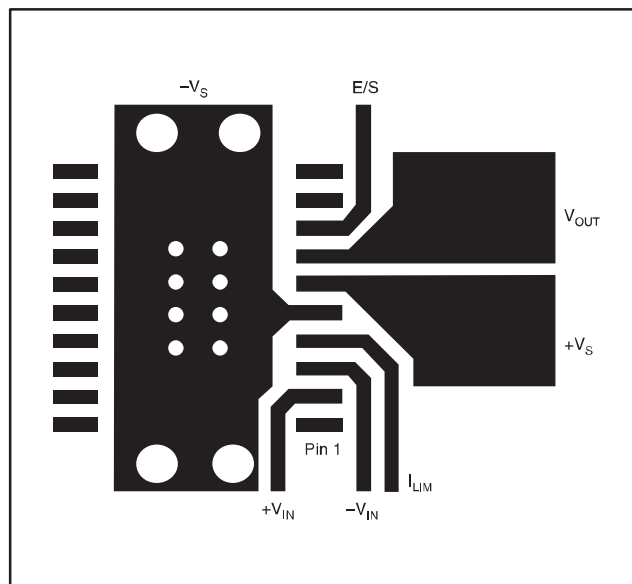

Figure 9. OPA561 Example Layout

Proper power-supply bypassing with low ESR capacitors is essential to achieve good performance. A parallel combination of small ceramic (around 100nF) and bigger (47μF) non-ceramic bypass capacitors will provide low impedance over a wide frequency range. Bypass capacitors should be placed as close as practical to the power-supply pins of the OPA561.

PCB traces conducting high currents, such as from output to load or from the power-supply connector to the power-supply pins of the OPA561 should be kept as wide and as short as possible. This will keep inductance low and also resistive losses to a minimum.

The eight holes in the landing pattern for the OPA561 are for the thermal vias that connect the PowerPAD of the OPA561 to the heatsink area on the printed circuit board. The additional four larger vias further enhance the heat conduction into the heatsink area. All traces conducting high currents are very wide for lowest inductance and minimal resistive losses. Note that the negative supply ($-V_S$) pin on the OPA561 is connected through the PowerPAD. This allows for maximum trace width for V_{OUT} and the positive power supply ($+V_S$).

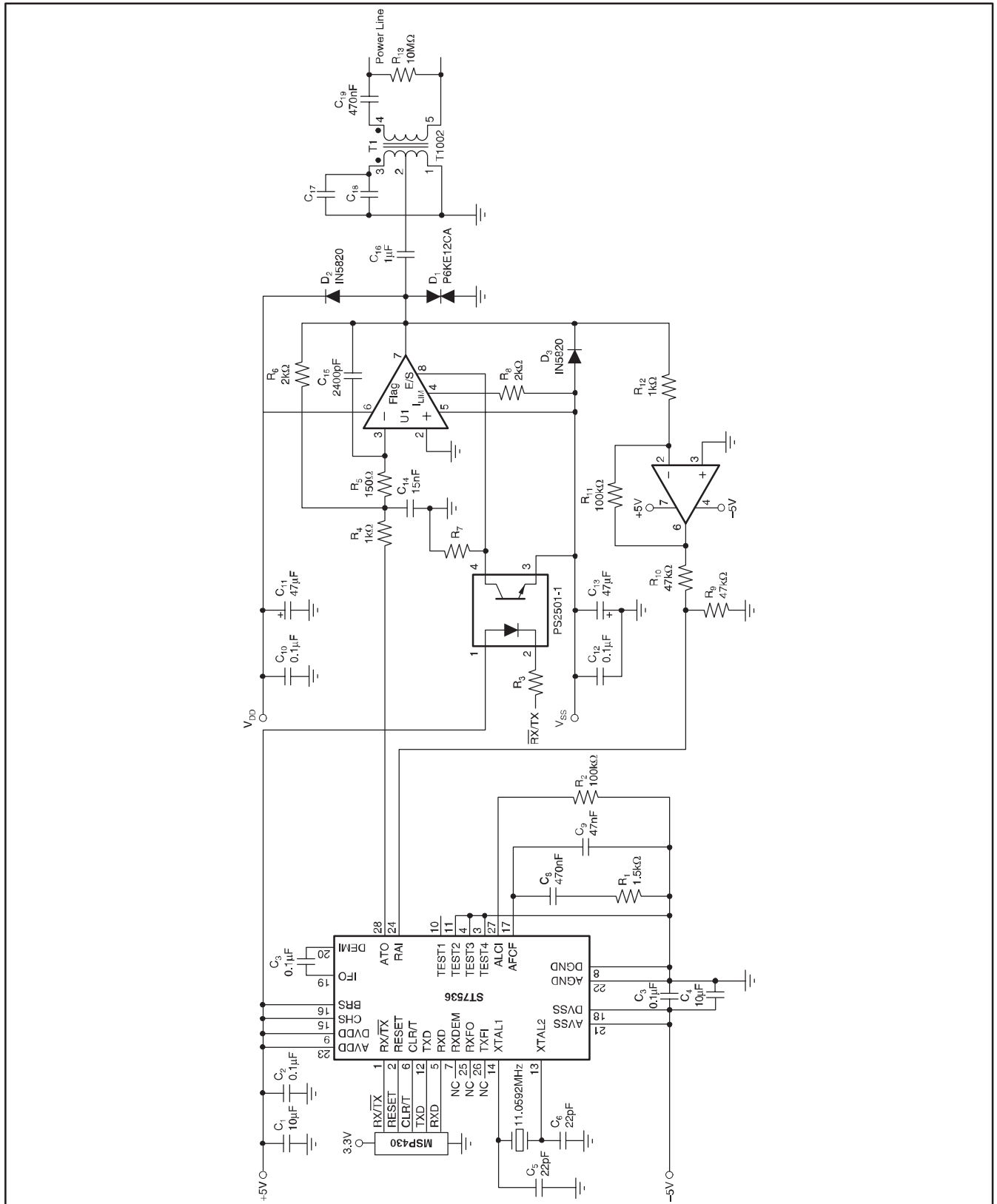

Figure 12. Power Line Communication Driver

PACKAGING INFORMATION

ORDERABLE DEVICE	STATUS(1)	PACKAGE TYPE	PACKAGE DRAWING	PINS	PACKAGE QTY
OPA561PWP	ACTIVE	HTSSOP	PWP	20	78
OPA561PWP/2K	ACTIVE	HTSSOP	PWP	20	2000

(1) The marketing status values are defined as follows:

ACTIVE: Product device recommended for new designs.

LIFEBUY: TI has announced that the device will be discontinued, and a lifetime-buy period is in effect.

NRND: Not recommended for new designs. Device is in production to support existing customers, but TI does not recommend using this part in a new design.

PREVIEW: Device has been announced but is not in production. Samples may or may not be available.

OBSOLETE: TI has discontinued the production of the device.

PWP (R-PDSO-G**) 20 PIN SHOWN

PowerPAD™ PLASTIC SMALL-OUTLINE PACKAGE

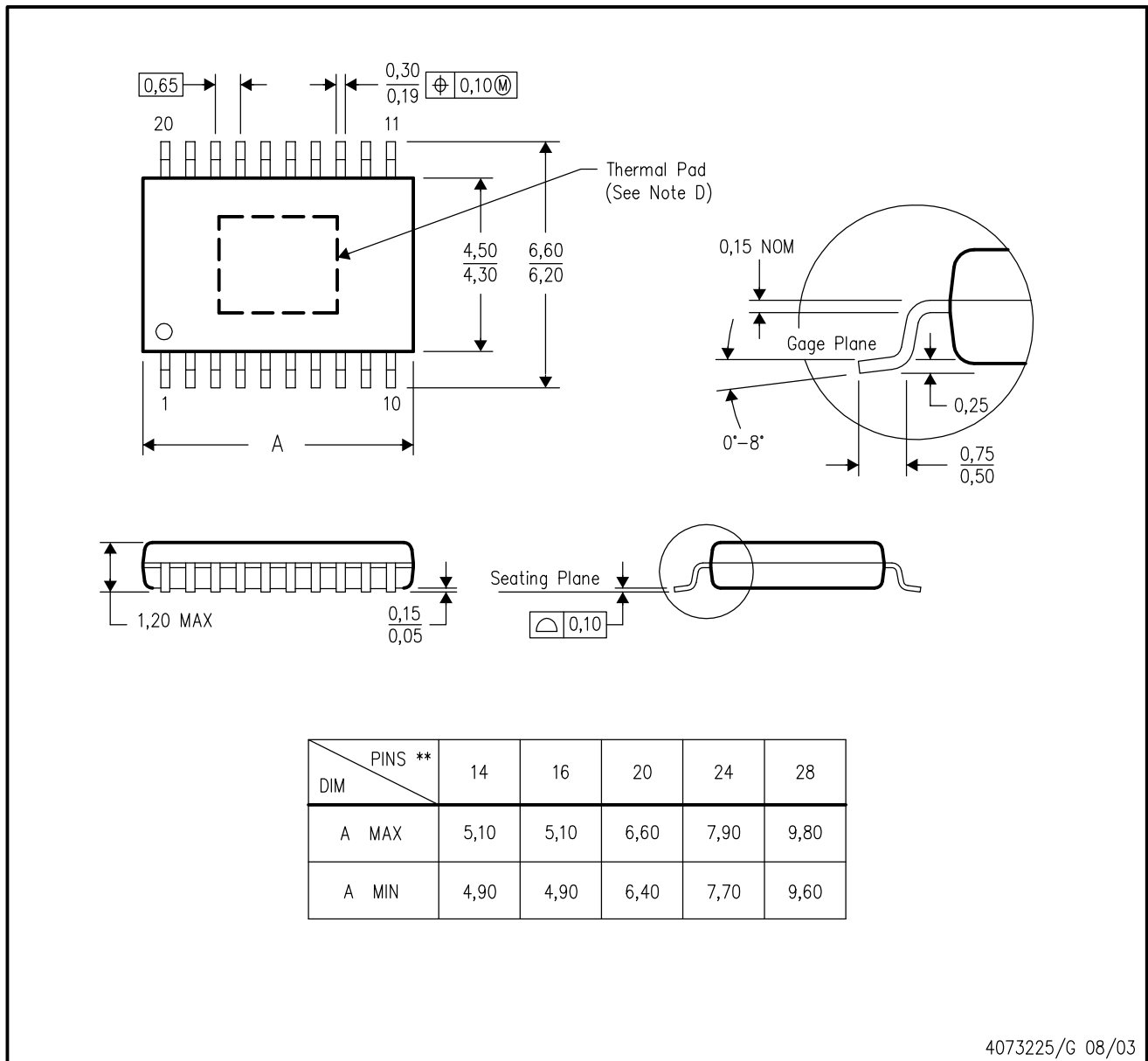

4073225/G 08/03

- NOTES:
- A. All linear dimensions are in millimeters.
 - B. This drawing is subject to change without notice.
 - C. Body dimensions do not include mold flash or protrusions.
 - D. This package is designed to be soldered to a thermal pad on the board. Refer to Technical Brief, PowerPad Thermally Enhanced Package, Texas Instruments Literature No. SLMA002 for information regarding recommended board layout. This document is available at www.ti.com <<http://www.ti.com>>.
 - E. Falls within JEDEC MO-153

PowerPAD is a trademark of Texas Instruments.

IMPORTANT NOTICE

Texas Instruments Incorporated and its subsidiaries (TI) reserve the right to make corrections, modifications, enhancements, improvements, and other changes to its products and services at any time and to discontinue any product or service without notice. Customers should obtain the latest relevant information before placing orders and should verify that such information is current and complete. All products are sold subject to TI's terms and conditions of sale supplied at the time of order acknowledgment.

TI warrants performance of its hardware products to the specifications applicable at the time of sale in accordance with TI's standard warranty. Testing and other quality control techniques are used to the extent TI deems necessary to support this warranty. Except where mandated by government requirements, testing of all parameters of each product is not necessarily performed.

TI assumes no liability for applications assistance or customer product design. Customers are responsible for their products and applications using TI components. To minimize the risks associated with customer products and applications, customers should provide adequate design and operating safeguards.

TI does not warrant or represent that any license, either express or implied, is granted under any TI patent right, copyright, mask work right, or other TI intellectual property right relating to any combination, machine, or process in which TI products or services are used. Information published by TI regarding third-party products or services does not constitute a license from TI to use such products or services or a warranty or endorsement thereof. Use of such information may require a license from a third party under the patents or other intellectual property of the third party, or a license from TI under the patents or other intellectual property of TI.

Reproduction of information in TI data books or data sheets is permissible only if reproduction is without alteration and is accompanied by all associated warranties, conditions, limitations, and notices. Reproduction of this information with alteration is an unfair and deceptive business practice. TI is not responsible or liable for such altered documentation.

Resale of TI products or services with statements different from or beyond the parameters stated by TI for that product or service voids all express and any implied warranties for the associated TI product or service and is an unfair and deceptive business practice. TI is not responsible or liable for any such statements.

Following are URLs where you can obtain information on other Texas Instruments products and application solutions:

Products		Applications	
Amplifiers	amplifier.ti.com	Audio	www.ti.com/audio
Data Converters	dataconverter.ti.com	Automotive	www.ti.com/automotive
DSP	dsp.ti.com	Broadband	www.ti.com/broadband
Interface	interface.ti.com	Digital Control	www.ti.com/digitalcontrol
Logic	logic.ti.com	Military	www.ti.com/military
Power Mgmt	power.ti.com	Optical Networking	www.ti.com/opticalnetwork
Microcontrollers	microcontroller.ti.com	Security	www.ti.com/security
		Telephony	www.ti.com/telephony
		Video & Imaging	www.ti.com/video
		Wireless	www.ti.com/wireless

Mailing Address: Texas Instruments
Post Office Box 655303 Dallas, Texas 75265