

Data sheet

Commercial Art.No.: 92.954.3053.1

Connector GST18I5S S1BZR1 SW

Connector GST18I5, 5 pole, male, screw connection, 250/400 V, 20 A, colour of coding: black, colour of housing: black



Commercial Art.No.	92.954.3053.1
EAN	4015573538771
Order Unit	1

Certificates / Approvals



Technical data

General

Rated current	20 A
Rated voltage	250 V / 400 V
Rated impulse voltage	4 kV
strain relief	yes
Pollution degree	2
Mechanical coding	Code 1
Lockable	self-locking (unlocking by tool)
Color of coding/ contact carrier	black
Marking of poles	3, N, PE, 2, 1
Color of housing inclusive strain relief	black

Connection Data

Cable diameter max.	13.5 mm
Cable diameter min.	9.5 mm
Connection cross section solid mm ² max.	2.5 mm ²
Connection cross section solid mm ² min.	0.75 mm ²
Connection cross section fine stranded mm ² max.	2.5 mm ²
Connection cross section fine stranded mm ² min.	0.75 mm ²
Terminations per pole	1
sheath strip length	46 mm
Wire strip length	9 mm

Model

Model	male
Connection type	screw connection
Degree of protection (IP)	IP20

Material

Housing material	Polyamide
halogen free	yes
Contact material	CuZn

Fire load	0 kWh
Insulation components continuous temperature	100 °C
Surface finish	Silver-plated

Dimensions

Length	75 mm
Width	47.7 mm
Height	17 mm

Classification

ECLASS 11	
ECLASS 8.1	27440605
ETIM 7.0	EC002560
ETIM 6.0	EC002560
ETIM 5.0	EC002560
ETIM 4.0	EC002560

Accessories

Commercial Art.No.:	Article-type description:	Description:
05.587.3156.0	Lock (G)ST18 WS	Locking device for cable to cable connection GST18i3-5, white
05.564.5353.0	cover cap GST18i3/4/5 SW	Cover piece 12 pole black for female parts GST18i3-6
05.564.5353.2	cover cap GST18i3/4/5 WS	Cover piece 12 pole white for female parts GST18i3-6
05.566.9253.0	cover cap GST18i5 BUCHSEN	Cover for female connectors GST18i5, black
05.587.3156.1	Lock (G)ST18 SW	Locking device for cable to cable connection GST18i3-5, black

Fits with

Commercial Art.No.:	Article-type description:	Description:
92.953.3053.1	Connector GST18i5S B1BZR1 SW	Connector GST18i5, 5 pole, female, screw connection, 250/400 V, 20 A, colour of coding: black, colour of housing: black
92.053.0058.1	Device connector GST18i5L B1H SW	GST18i5 PCB mount with additional mounting option, 5 pole, female (horizontal), coding mains 250 V/ 400 V, 20 A, coding color black
92.257.1000.1	Cable assembly GST18i5KSBS 15 10SW	GST18i5 connection cable female - male, length 1.0 m, 5 pole, coding mains 250 V/ 400 V, 16 A, coding color black, strain relief color black, cable color black, cross section 1.5 mm ² , cable type H05VV-F, fire class: Eca
92.257.1003.1	Cable assembly GST18i5K1B- 15 10SW	GST18i5 extension cable female - free end, length 1.0 m, 5 pole, coding mains 250 V/ 400 V, 16 A, coding color black, strain relief color black, cable color black, cross section 1.5 mm ² , cable type H05VV-F, fire class: Eca
92.257.1004.1	Cable assembly GST18i5KS-S 15 10SW	GST18i5 extension cable male - free end, length 1.0 m, 5 pole, coding mains 250 V/ 400 V, 16 A, coding color black, strain relief color black, cable color black, cross section 1.5 mm ² , cable type H05VV-F, fire class: Eca

These dimensions will be especially checked at delivery
 Only inspection dimensions
 With /E marked dimensions are only valid for internal use

Diese Maße werden bei Abnahme besonders geprüft
 Ausschließliche Prüfmaße
 Mit /E gekennzeichnete Maße sind nur für interne Zwecke gültig

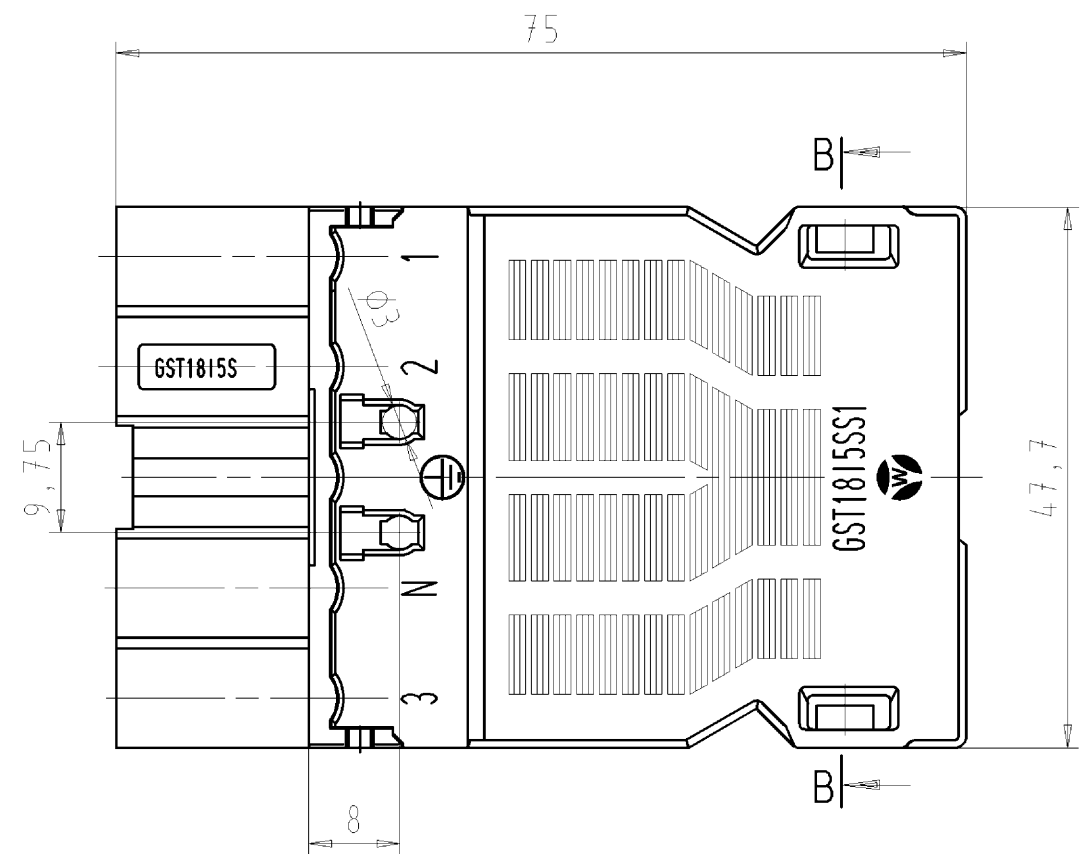

Teilschnitt B-B

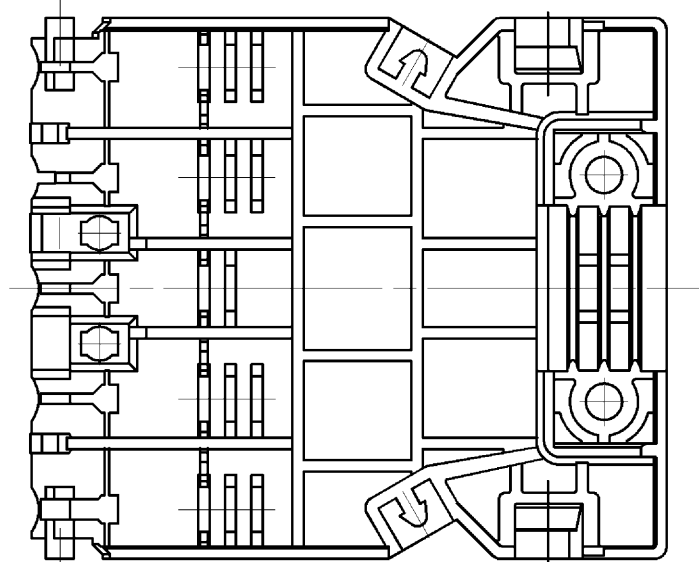
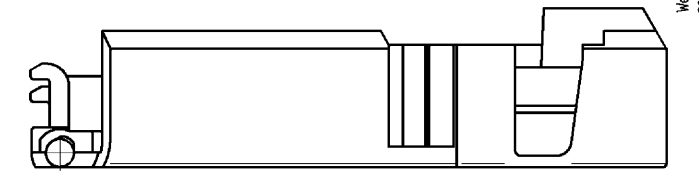
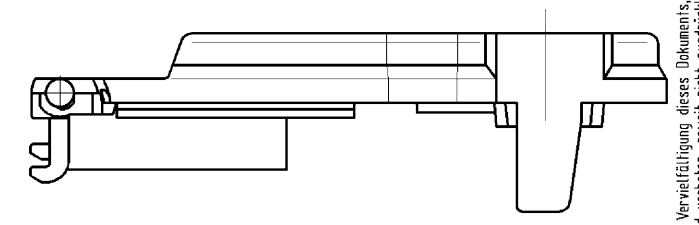
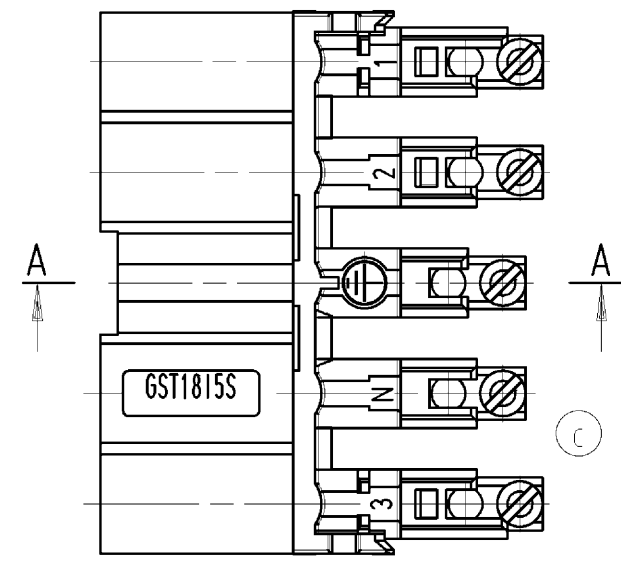
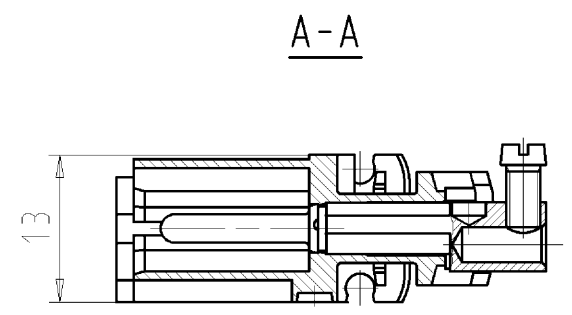
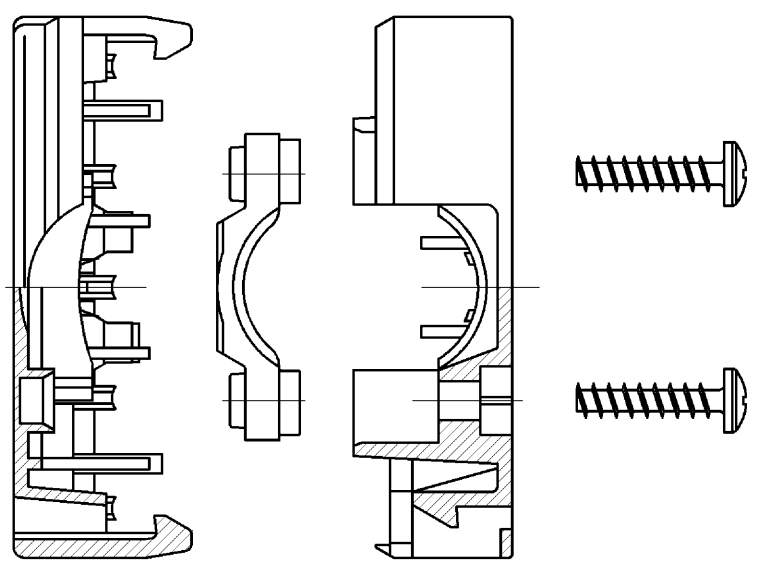

Weitere Daten siehe Katalog
 further data see catalog

Teile - Nr. part-no.	Farbe colour	Typ/type		Kabel-Außendurchmesser Klemmbereich cable lockable	
		ⓑ		H05VV..	NYM..
92.954.3053.0	weiß / white	GST1815S	S1BZR1	9,5 - 13,5 mm	10,5 - 12,5 mm
92.954.3053.1	schwarz / black	GST1815S	S1BZR1		
92.954.3153.0	weiß / white	GST1815S	S1BZR2		
92.954.3153.1	schwarz / black	GST1815S	S1BZR2	7,0 - 10,0 mm	

Tolerierung Size ISO 14405/Tolerance system Size ISO 14405. (This ISO-standard describes the envelope principle. According to the envelope principle the deviations of form and parallelism are limited by the size tolerances).				ja/yes <input checked="" type="checkbox"/> Stoffverbots- und Deklarationsliste nach UU-TOM-05/03 ist einzuhalten. Conformity with Wieland document UU-TOM-05/03 (list of prohibited / declarable hazardous substances) to be declared!			
Freitoleranz nach General tolerance		CAD - Zeichnung, keine manuellen Änderungen CAD - drawing, no manual modifications allowed		1. Verwendung: First Use:		Blatt: 1 von 1 Sheet: of 1	
		Werkstoff/Material		2004 Tag/Date Name		Zeichnung Nr./Drawing No. Index	
				08.12. Treschan		T 92.954.3053.0 01K d	
		Maßstab/Scale		gezeichnet drawn		Maße in mm/Dimensions are in mm	
d 14.01.2013/		%		geprüft checked			
c 19.01.2010/		Vol. mm³ Ofl./Surf. mm²		Normgepr. Stand. check			
b 18.03.2009/		Vol. mm³ Ofl./Surf. mm²		Ersatz für/Replacement for: -			
a 16.11.2005/		wieland		Type		Benennung/Title male connector with strain relief	
Index Datum / Blatt Date / Sheet		Elektrische Verbindungen		Type		STECKERTEIL MIT ZUGENTLASTUNG	
Änderung/Revision				Type		Schraubanschluss/ screw connection	
				Type		ⓐ 250/400V AC, 20A, 2,5qmm	

Weitergabe sowie Vervielfältigung dieses Dokuments, Verwertung und Mitteilung seines Inhalts sind verboten, soweit nicht ausdrücklich gestattet.
 The reproduction, distribution and utilization of this document as well as the communication of its contents to others without express authorization is prohibited.