

1W isolated DC-DC converter  
Fixed input voltage, unregulated single output



Continuous Short  
Circuit Protection



RoHS Patent Protection



EN 62368-1 BS EN 62368-1

## FEATURES

- Continuous short-circuit protection
- Operating ambient temperature range: -40°C to +105°C
- Compact SMD package
- I/O isolation test voltage 3.5k VDC
- Industry standard pin-out
- Meet AEC-Q100 standards
- Production process meets IATF16949 system

The CF0505XT-1WR3 is designed for application where isolated output is required from a distributed power system. It can be used in automobile motor control and drive system. Such as motor vehicle communication system controller, engine control system, the ignition system, the motor voltage monitoring, the electronic accelerator pedal, automobile tire pressure detection system, doors and tail lights controller, air conditioning control and battery management system (BMS), etc.

## Selection Guide

Certification	Part No.	Input Voltage (VDC)	Output		Full Load Efficiency (%) Min./Typ.	Capacitive Load (μF) Max.
		Nominal (Range)	Voltage (VDC)	Current (mA) Max./Min.		
EN/BS EN	CF0505XT-1WR3	5 (4.5-5.5)	5	200/20	78/82	2200

## Input Specifications

Item	Operating Conditions	Min.	Typ.	Max.	Unit
Input Current (full load / no-load)	5VDC input	--	244/5	257/10	mA
Reflected Ripple Current*		--	15	--	
Surge Voltage (1sec. max.)		-0.7	--	9	VDC
Input Filter		Capacitance filter			
Hot Plug		Unavailable			

Note: \* Reflected ripple current testing method please see DC-DC Converter Application Notes for specific operation.

## Output Specifications

Item	Operating Conditions	Min.	Typ.	Max.	Unit
Voltage Accuracy		See output regulation curve(Fig. 1)			
Linear Regulation	Input voltage change: ±1%	--	--	1.2	%
Load Regulation	10%-100% load	--	10	15	
Ripple & Noise*	20MHz bandwidth	--	30	70	mVp-p
Temperature Coefficient	Full load	--	±0.02	--	%/°C
Short-circuit Protection		Continuous, self-recovery			

Note:\* The "parallel cable" method is used for Ripple and Noise test, please refer to DC-DC Converter Application Notes for specific information.

## General Specifications

Item	Operating Conditions	Min.	Typ.	Max.	Unit
Isolation	Input-output Electric Strength Test for 1 minute with a leakage current of 1mA max.	3500	--	--	VDC
Insulation Resistance	Input-output resistance at 500VDC	1000	--	--	MΩ
Isolation Capacitance	Input-output capacitance at 100kHz/0.1V	--	20	--	pF
Operating Temperature	Derating when operating temperature ≥ 85°C. (see Fig. 2)	-40	--	105	°C
Storage Temperature		-55	--	125	
Case Temperature Rise	Ta=25°C	--	15	--	

Storage Humidity	Non-condensing	--	--	95	%RH
Reflow Soldering Temperature*		Peak temp. $\leq 245^{\circ}\text{C}$ , maximum duration time $\leq 60\text{s}$ over $217^{\circ}\text{C}$			
Switching Frequency	Full load, nominal input voltage	--	270	--	kHz
MTBF	MIL-HDBK-217F@25°C	3500	--	--	k hours
Vibration		10-1000Hz, 1mm, 10G, along X, Y and Z (4 cycles)			
Moisture Sensitivity Level (MSL)	IPC/JEDEC J-STD-020D.1	Level 1			

Note: \* For actual application, please refer to IPC/JEDEC J-STD-020D.1.

## Mechanical Specifications

Case Material	Black plastic; flame-retardant and heat-resistant (UL94V-0)
Dimensions	13.20 x 11.40 x 7.25 mm
Weight	1.4g(Typ.)
Cooling Method	Free air convection

## Electromagnetic Compatibility (EMC)

Emissions	CE	CISPR25/EN55025 CLASS 1 (see Fig. 4 for recommended circuit)
	RE	CISPR25/EN55025 CLASS 1 (see Fig. 4 for recommended circuit)
Immunity	ESD	ISO10605 Air $\pm 8\text{kV}$ , Contact $\pm 4\text{kV}$ perf. Criteria B

## Typical Characteristic Curves

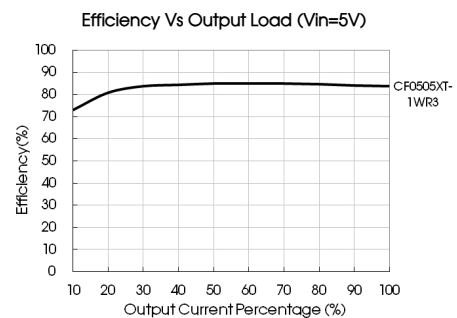
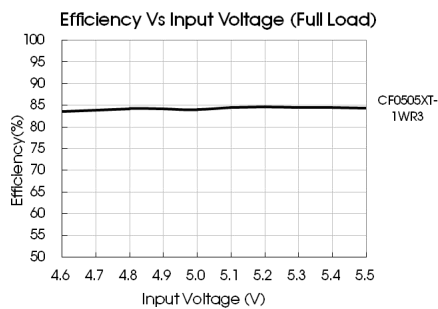
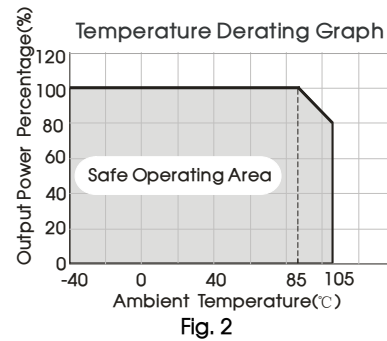
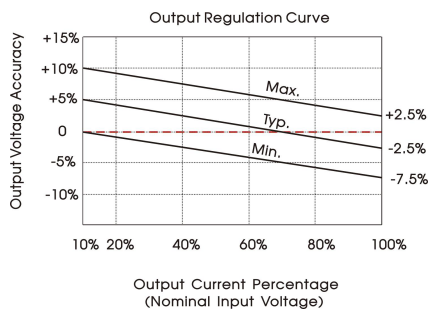

## Design Reference

### 1. Typical application circuit

Input and/or output ripple can be further reduced, by connecting a filter capacitor from the input and/or output terminals to ground as shown in Fig. 3.

Choosing suitable filter capacitor values is very important for a smooth operation of the modules, particularly to avoid start-up problems caused by capacitor values that are too high. For recommended input and output capacitor values refer to Table 1.



Fig. 3

Recommended capacitive load value table (Table 1)

Vin	Cin	Vo	Cout
5VDC	4.7 $\mu\text{F}$ /16V	5VDC	10 $\mu\text{F}$ /16V

2. EMC solution-recommended circuit

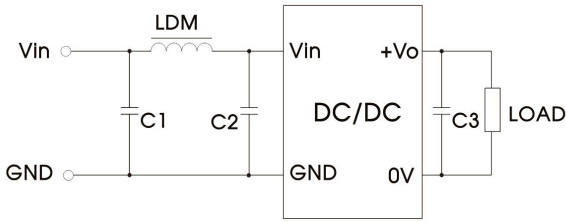

Fig. 4

EMC recommended circuit value table (Table 2)

Emissions	Input voltage	5VDC
	C1/C2	4.7μF /25V
	C3	10μF/16V
	LDM	6.8μH

3. Output load requirements

For a reliable and efficient operation of the converter, the minimum load should never be less than 10% of the rated output load. If the total required output power is below 10%, a parallel bleeding resistor is required on the output (The sum of the efficient power and resistor consumption power is not less than 10%).

4. For additional information, please refer to DC-DC converter application notes on

[www.mornsun-power.com](http://www.mornsun-power.com)

Dimensions and Recommended Layout

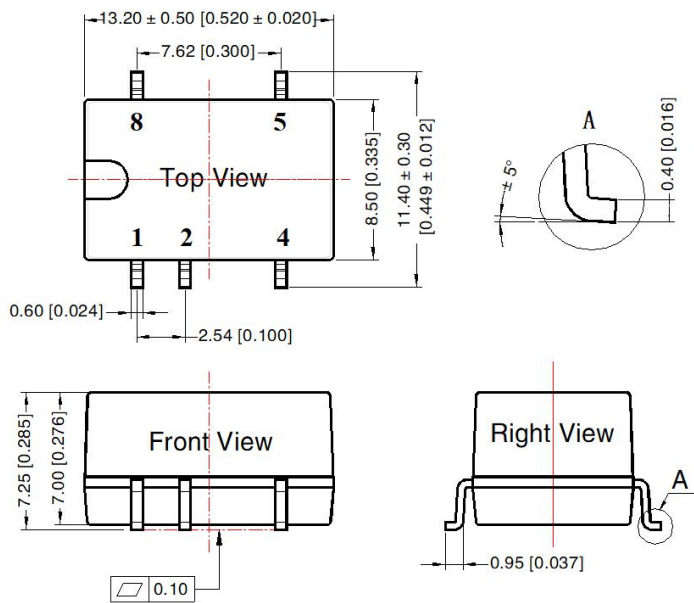

Note:  
Unit: mm[inch]  
Pin section tolerances: ± 0.10[± 0.004]  
General tolerances: ± 0.25[± 0.010]

THIRD ANGLE PROJECTION

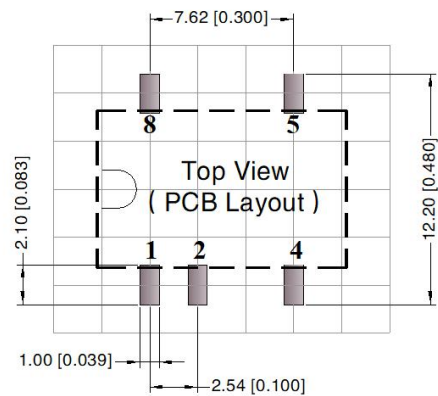

Note: Grid 2.54\*2.54mm

Pin-Out	
Pin	Mark
1	GND
2	Vin
4	0V
5	+Vo
8	NC

NC: Pin to be isolated from circuitry

Notes:

1. For additional information on Product Packaging please refer to [www.mornsun-power.com](http://www.mornsun-power.com). Tube Packaging bag number: 58210024, Roll Packaging bag number: 58200054;
2. If the product is not operated within the required load range, the product performance cannot be guaranteed to comply with all parameters in the datasheet;
3. The maximum capacitive load offered were tested at input voltage range and full load;
4. Unless otherwise specified, parameters in this datasheet were measured under the conditions of  $T_a=25^{\circ}\text{C}$ , humidity<75%RH with nominal input voltage and rated output load;
5. About the AEC-Q100 specific test project, please contact our technicians directly for specific information;
6. All index testing methods in this datasheet are based on our company corporate standards;
7. We can provide product customization service, please contact our technicians directly for specific information;
8. Products are related to laws and regulations: see "Features" and "EMC";
9. Our products shall be classified according to ISO14001 and related environmental laws and regulations, and shall be handled by qualified units.

MORNSUN Guangzhou Science & Technology Co., Ltd.

Address: No. 5, Kehui St. 1, Kehui Development Center, Science Ave., Guangzhou Science City, Huangpu District, Guangzhou, P. R. China  
Tel: 86-20-38601850 Fax: 86-20-38601272 E-mail: [info@mornsun.cn](mailto:info@mornsun.cn) [www.mornsun-power.com](http://www.mornsun-power.com)