

深圳市维拓精电科技有限公司
WTL International Limited

APPROVAL SHEET

DESCRIPTION :	7.0*5.0mm 4 Pads SMD Crystal Oscillator			
NOMINAL FREQ.:	100.000MHz			
WTL P/N:	WTL7K85425FO			
VERSION:	1			
DATE:	2022.10.13			
Customer	Customer P/N			
Promelectronica				
Customer Signature	WTL			
	Approved by: <i>Kavin Liu</i>			
	Checked by: <i>Shu Ping</i>			
	Issued by: <i>colin zhan</i>			
REVISION HISTORY				
Revised Page	Revision Content	Date	Ref. No.	Reviser



CONTENT CATALOG

APPROVAL SHEET	P. 1
CONTENT CATALOG	P. 2
ELECTRICAL SPECIFICATIONS	P. 3
DIMENSIONS	P. 4
MARKING	P. 4
SUGGESTED REFLOW PROFILE	P. 5
RELIABILITY SPECIFICATIONS	P. 5
SUBSTANCES IN PRODUCT	P. 6
PACKING SPECIFICATIONS	P. 7
WTL PART NUMBER SYSTEM	P. 8

Attachment(s):

- 1.Product Specification Sheet
- 2.Electrical Testing Report
- 3.Reliability Report
- 4.ICP Test Report (SGS)

FEATURE

- Typical 7.0×5.0×1.3mm ceramic SMD package
- Operation voltage : 1.8V , 2.5V , 3.3V
- Tri-state enable / disable
- Output frequency up to 166MHZ
- RoHS compliant / Pb free

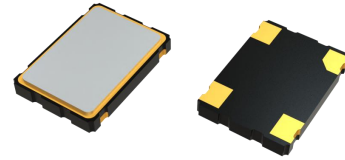

1、 ELECTRICAL SPECIFICATIONS

Parameter		Min.	Typ.	Max.	Units	Test Condition
1.1	Nominal Frequency	100.000			MHz	Mode of Oscillation /3 Overtone
1.2	Frequency stability	-100		+100	ppm	Inclusive of operating temperature range supply voltage and load
	Aging	-3		+3	ppm	Frequency drift in first year
1.3	Operating Temperature Range	-40		+85	°C	The operating temperature range over which the frequency stability is measured
1.4	Storage Temperature Range	-55		+125	°C	
1.5	Supply voltage	2.97	3.3	3.63	V	
1.6	Current			35	mA	At maximum supply voltage
1.7	Output waveform	CMOS				
1.8	Duty Cycle	45	50	55	%	
1.9	Start Time			5	mSec	
1.10	Transition Time :Rise/Fall Time			10	nSec	
1.11	Output Level CMOS	Out High(Logic"1")	2.97		V	
		Out Low(Logic"0")		0.33	V	
1.12	Output Load			15	pF	
1.13	Tri-State	Output Active	2.31		V	Pin 1 Tri-state
		Output in High-Impedance state			0.99	V
1.14	RMS Phase Jitter			1	pSec	Integrated 12KHz to 20MHz

Series TC7, P/N: WTL7K85425FO
7.0×5.0 mm SMD Crystal Oscillator



REMARK: SPECIFICATIONS SUBJECT TO CHANGE WITHOUT PRIOR NOTICE. PLEASE CONFIRM WITH OUR SALES ENGINEER.

2、 DIMENSIONS (Unit: mm)

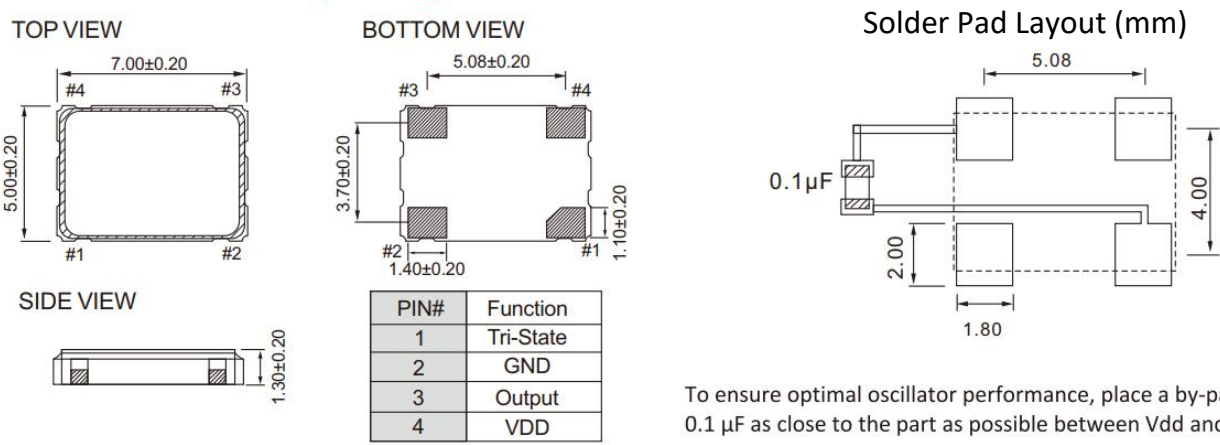

To ensure optimal oscillator performance, place a by-pass capacitor of 0.1 μF as close to the part as possible between Vdd and GND pads.

3、 MARKING

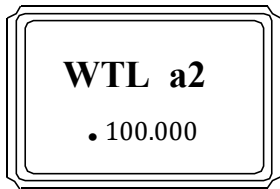

- WTL → Brand Logo
- 100.000 → Frequency (MHz)
- a → Week (a、 b、 c...z、 A、 B、 C...Y、 Z ,from 1 to 52week)
- 2 → YEAR (1=2021year, 2=2022year, 9=2029year....)

Marking Instruction :

The date code was marked on the crystal body, which will be easily traced back in case of quality issue.

4、 SUGGESTED REFLOW PROFILE

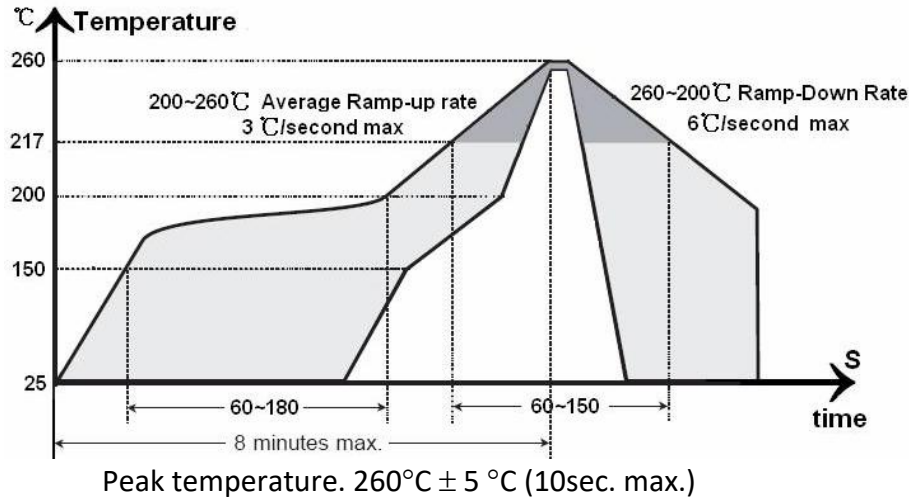

5、 RELIABILITY SPECIFICATIONS

Item	Conditions	Result
Low Temp. Storage (MIL-STD-883)	Put the crystal into the -40°C ± 2°C constant temperature box for 500±2 H, Measurement taken after 2 hour.	ΔF ≅ ±5 PPM
High Temp. Storage (MIL-STD-883)	Put the crystal into the +100 °C ± 2 °C constant temperature box for 500±2 H, Measurement taken after 2 hour.	ΔF ≅ ±5 PPM
High Temp & Humidity (JIS C5023)	Put the crystal into the constant temperature & humid with the temperatures 85 °C ± 3 °C and the humidity 98% for 500±2 H. Measurement taken after 2 hour.	ΔF ≅ ±5 PPM
Thermal Shock (MIL-STD-883)	Put the crystal into the constant temperature -55 °C ± 2 °C for 30±1M, then change the temperature to +85 °C ± 2 °C for 30±1M, the total is 100times. Measurement taken after 2 hour.	ΔF ≅ ±5 PPM
Resistance To Soldering Heat (MIL-STD-202)	Passed through the re-flow oven under the following condition. Preheat to 150°C±5°C for 60 to 120sec, and peak 265°C±5°C for 10s±3sec. Measurement taken after DUT being left at room temperature for at 24±2 hours	ΔF ≅ ±5 PPM
Drop Test (JIS C6701)	The crystal fall off the cement floor with the height 100cm±5cm for 3 times. Measurement taken after 2 hour.	ΔF ≅ ±5 PPM
Vibration Test (MIL-STD-883)	Apply 0.75mm vibration at sweep frequency 10 ~ 500 Hz, for 2h. 10 cycles in each direction of 3 axis. Measurement taken after 2 hour.	ΔF ≅ ±5 PPM
Shock MIL-STD-202F	Peak 1000m/s ² , normal width 6ms half sine wave form, 3.7m/s, 3 perpendicular axis of samples, 3 cycles / direction, total 18 cycles. Measurement taken after 2 hour.	ΔF ≅ ±5 PPM
Fine Leak (MIL-STD-883)	Helium Bombing 4.5kgf/cm ² for 2 hr	Less than 1*10 ⁻⁸ atm.c.c./sec, Helium
Solderability	In 245 ± 5°C solder bath for 2 ± 0.5 seconds. 8-12X magnifier.	Terminals shall be covered more then

6、SUBSTANCES IN PRODUCT (weigh:157.5mg)

Drawing number	Homogeneous Material Name.	Disassembly Unit/component description	Substance Name	CAS No.	Substance Mass. (mg)	Content Rate(%)per
7050 OSC	Crystal blank	Quartz	SiO ₂	14808-60-7	5.5000	100.00%
	Electrode	Electrode	Ag	7440-22-4	15.0000	100.00%
	Package	Ceramic	Al ₂ O ₃	1344-28-1	68.7440	66.10%
			Mn ₂ O ₃	1317-34-6	2.2880	2.20%
			SiO ₂	7631-86-9	0.4160	0.40%
			MgO	1309-48-4	4.5660	4.39%
			MoO ₃	1313-27-5	0.4160	0.40%
			Electric conductor	Tungsten-W	7440-33-7	6.2400
		Mo		7439-98-7	0.2080	0.20%
		Brazing material	Silver-Ag	7440-22-4	1.8720	1.80%
			Copper-Cu	7440-50-8	0.7280	0.70%
		Kovar ring	Iron-Fe	7439-89-6	9.0480	8.70%
			Nichel-Ni	7440-02-0	4.8880	4.70%
			Cobalt-Co	7440-48-4	2.9120	2.80%
		Ni plating	Nickel-Ni	7440-02-0	1.0400	1.00%
			Cobalt-Co	7440-48-4	0.4160	0.40%
	Au plating	Gold-Au	7440-57-5	0.2080	0.20%	
	Alloy	Lid	Iron	7439-89-6	11.7106	53.23%
			Nickel	7440-02-0	6.4878	29.49%
			Cobalt	7440-48-4	3.6872	16.76%
			Mn	7439-96-5	0.0858	0.39%
			Silicone Si	7440-21-3	0.0176	0.08%
			Copper Cu	7440-50-8	0.0110	0.05%
	Conduct Adhesive	Conduct Adhesive	Ag	7440-22-4	3.5000	70.00%
			Pd	7440/5/3	0.2500	5.00%
			C ₁₁ H ₂₄	1120-21-4	0.5000	10.00%
			C ₁₂ H ₂₆	112-40-3	0.2500	5.00%
			SiO ₂	7631-86-9	0.5000	10.00%
	Connect	Gold Wire	Gold-Au	7440-57-5	5.7600	100.00%
	IC	IC	Silicon Si	7440-21-3	0.2392	99.65%
Al			7429-90-5	0.0008	0.34%	

All the products we provide meet the requirements of RoHS and Reach regulations, and we send SGS for ICP test every year.

7、PACKING SPECIFICATIONS (Unit: mm)

TAPE SPECIFICATION :

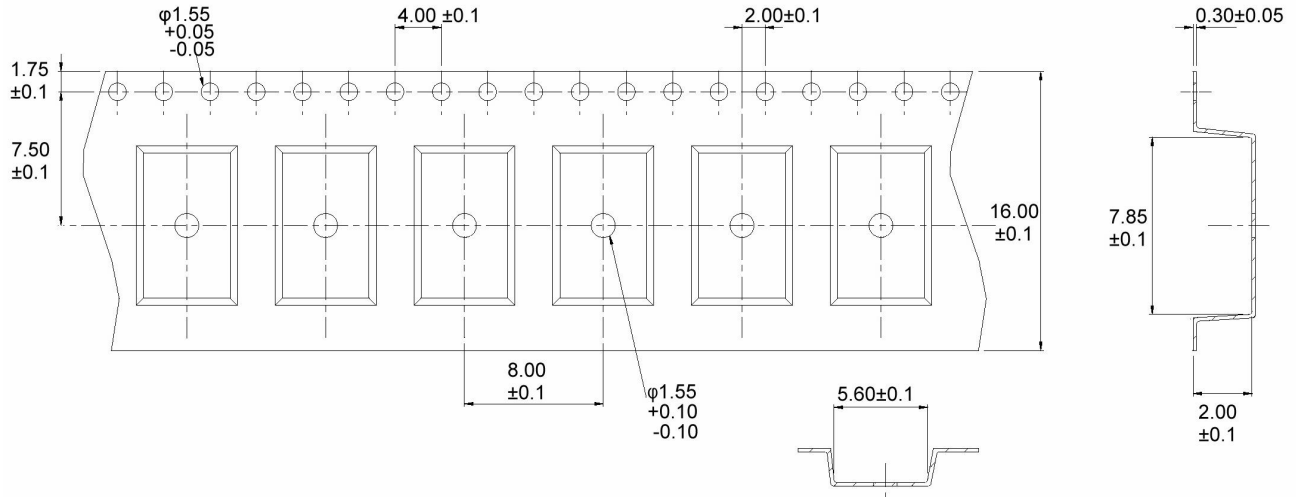

THE DIRECTION OF PACKING :

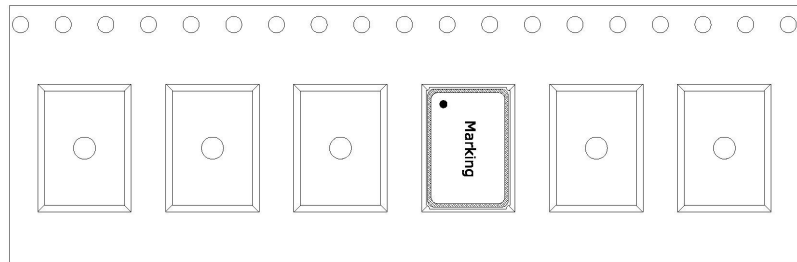

OUTLINE DIMENSION :

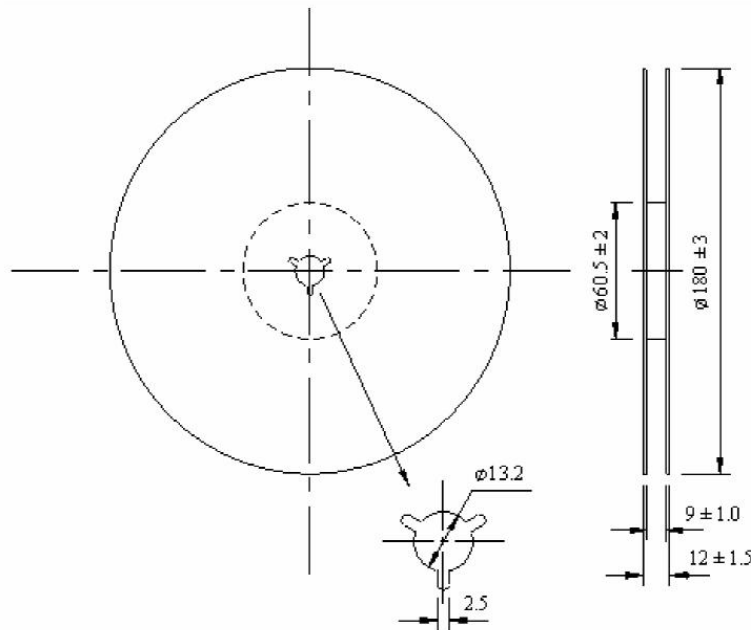

Q'ty: 1000pcs/Reel

8、WTL PART NUMBER SYSTEM :

For example: WTL7K85425FO

[Instructions: for project management, WTL will trace back the part number to developer wherever it goes]

WTL - 7K - 85425 - FO

WTL: Brand

8M : Package Code

85425: Serial number , flow code , without any rules

FO: WTL Developer Code, for example: VH,CH,PZ,RZ,ML