

Category: 面板式连接器/Plug-in terminal-plug



Product name: 面板连接器M12A05C-MPSFHUR

Product Description: A coding , 5芯面板式不带线焊杯式针式连接器 锁板螺母M16*1.5 , 板前安装

Product Picture

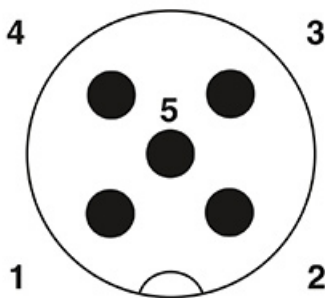
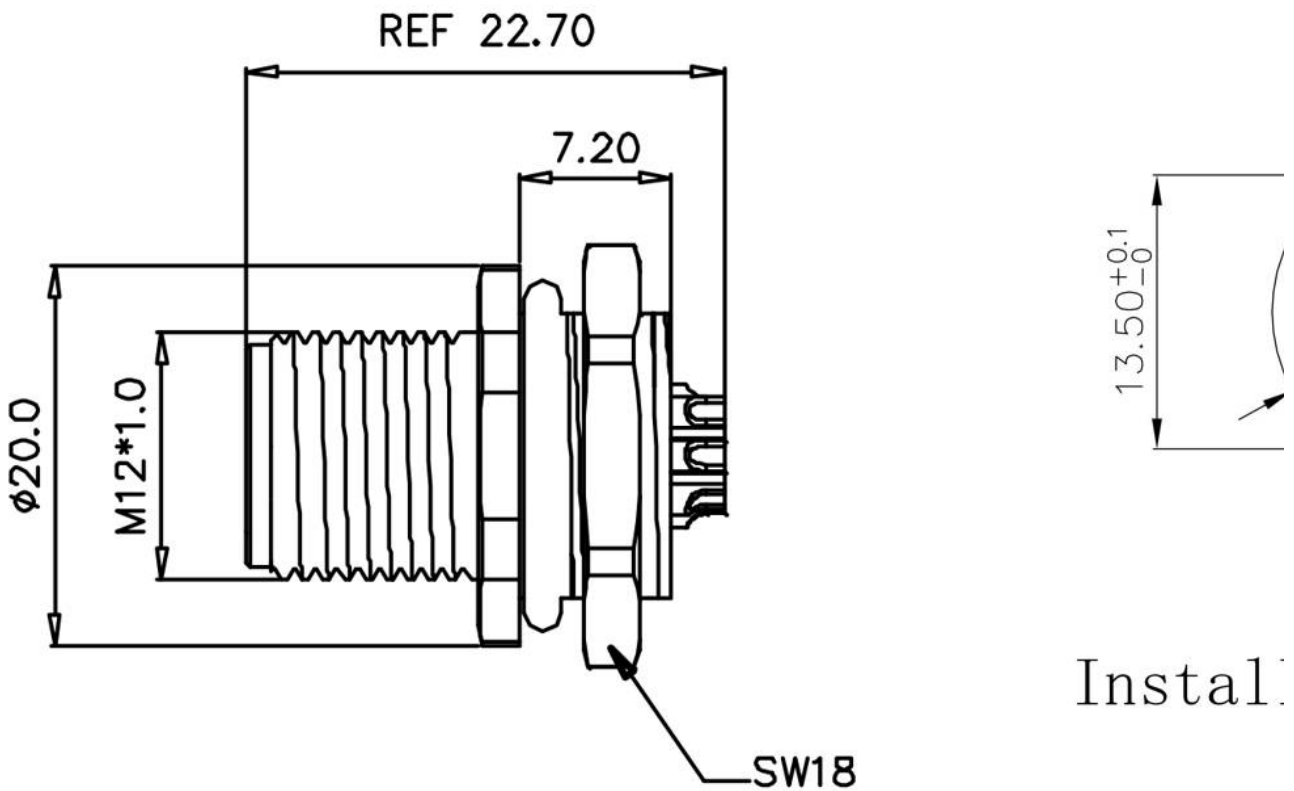

基本信息 /Basic Information

产品型号 SUPU ID	M12A05C-MPSFHUR
接口螺纹规格 Thread type	M12

类别 Category	针式
产品位数 Number of positions	5
接口编码类型 Coding	A-Coding
防护等级 Degree of protection	IP67
安装方式 Mounting type	板前安装
连接方式 Connection method	焊杯式
机械寿命 Mounting cycle	≥100
参照标准 Standards	IEC61076-2-101

电气参数 /Electrical properties

额定电压 Rated Voltage	60V DC
额定电流 Rated Current	4A
绝缘阻抗 Insulation Resistance	≥100MΩ
接触阻抗 Contact resistance	< 10mΩ
污染等级 Degree of pollution	3
工作温度 Ambient temperature (operation)	-40~+85°C

材料信息 /Material Data

插针/表面材料 Contact material/plating	CuZn/Ni/Au
插芯材料 Contact carrier material	PA
螺丝/螺母材料 Screw/nut material	CuZn
密封材料 Sealing material	NBR

Ningbo Supu Electronics Co.,Ltd

Zip code: 315303

Fax: +86 574-63288170

E-mail : askme@supu.cn

Address: No. 625, Kandun Town Street, Cixi
City, Zhejiang Province

Switchboard: +86 574-63288158

E-mail : askme@supu.cn

Service Hotline: 400-626-6336



Code

File date : 2024-09-12 17:05

Product Entry : 2023-09-07

The right to modify data belongs to
Supu.