

DETAILS

Product Number	C12419_STRADA-2X2-A-T
Family	Strada-Module
Type	Lens array
Color	clear
Diameter	50x50 mm
Height	7,3 mm
Style	rectang
Optic Material	PMMA
Holder Material	
Fastening	glue, screw, pin
Status	production ready
ROHS Compliant	Yes
Date Updated	21/04/2016

OPTICAL PROPERTIES

LED	Viewing Angle	Light Beam	Efficiency	cd/lm	Connector
XM-L	Asymmetric deg	Streetligh...	93 %	0.420	-
XP-G	Asymmetric deg	Streetligh...	93 %	0.450	-
XT-E	Asymmetric deg	Streetligh...	93 %	0.470	-
XM-L2	asymmetric deg	Streetligh...	94 %	0.700	-
XP-G2	asymmetric deg	Streetligh...	94 %	0.900	-
XP-L	Asymmetric deg	Streetligh...	94 %	0.670	-
XP-L HI	asymmetric deg	Streetligh...	94 %	0.890	-
XP-L2	Asymmetric deg	Streetligh...	94 %	0.610	-
H35C0 (LEMWA33)	Asymmetric deg	Streetligh...	96 %	0.850	-
H35C1 (LEMWA33)	Asymmetric deg	Streetligh...	94 %	0.790	-
LUXEON Rebel ES	Asymmetric deg	Streetligh...	93 %	0.450	-
LUXEON T	Asymmetric deg	Streetligh...	94 %	0.800	-
LUXEON H50-2	Asymmetric deg	Streetligh...	-	sim: 0.000	-
LUXEON Q	asymmetric deg	Streetligh...	94 %	0.800	-
LUXEON MZ	asymmetric deg	Streetligh...	94 %	0.760	-
LUXEON TX	Asymmetric deg	Streetligh...	94 %	0.920	-
NS9x383	Asymmetric deg	Streetligh...	95 %	0.680	-
NVSW3x9A	Asymmetric deg	Streetligh...	94 %	0.730	-
NVSxE21A	asym deg	Streetligh...	94 %	0.880	-
Oslon Square PC	Asymmetric deg	Streetligh...	94 %	0.800	-
Oslon Square Gen3	Asymmetric deg	Streetligh...	94 %	0.800	-
Duris S8	sim: Asymmetric	Streetligh...	sim: 93 %	sim: 0.660	-
Fortimo FastFlex LED board 2x8/740 DA 69	Asymmetric deg	Streetligh...	94 %	0.890	-
LH351B	Asymmetric deg	Streetligh...	94 %	0.730	-
LH351Z	asymmetric deg	Streetligh...	94 %	0.790	-





PRODUCT DATASHEET

Strada-Module series

last update 21/4/2016

OPTICAL PROPERTIES

LED	Viewing Angle	Light Beam	Efficiency	cd/lm	Connector
LH351D	Asymmetric deg	Streetligh...	94 %	0.620	-
Z5	Asymmetric deg	Streetligh...	93 %	-	-
Acrich MJT 4040	Asymmetric deg	Streetligh...	94 %	0.730	-
Z5M1/Z5M2	asymmetric deg	Streetligh...	94 %	0.800	-
Z8Y22P	Asymmetric deg	Streetligh...	94 %	0.760	-
TL1L3	Asymmetric deg	Streetligh...	94 %	0.680	-
TL1L4	Asymmetric deg	Streetligh...	94 %	0.850	-
RLE G1 49x223mm 4000lm xxx EXC OT	Asymmetric deg	Streetligh...	94 %	0.790	-
RLE G1 49x245mm 4000lm xxx EXC OT	Asymmetric deg	Streetligh...	94 %	0.790	-
RLE G1 49x121mm 2000lm xxx EXC OT	Asymmetric deg	Streetligh...	94 %	0.790	-
RLE G1 49x133mm 2000lm xxx EXC OT	Asymmetric deg	Streetligh...	94 %	0.790	-

D

C

B

A

4

4

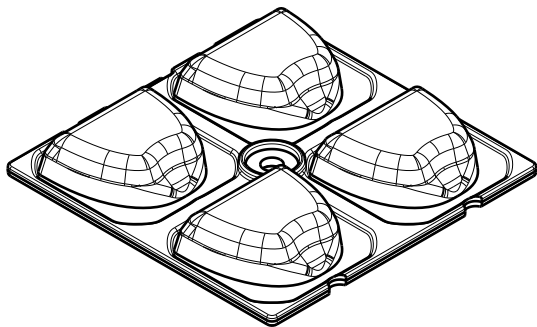

Isometric view
Scale: 1:1

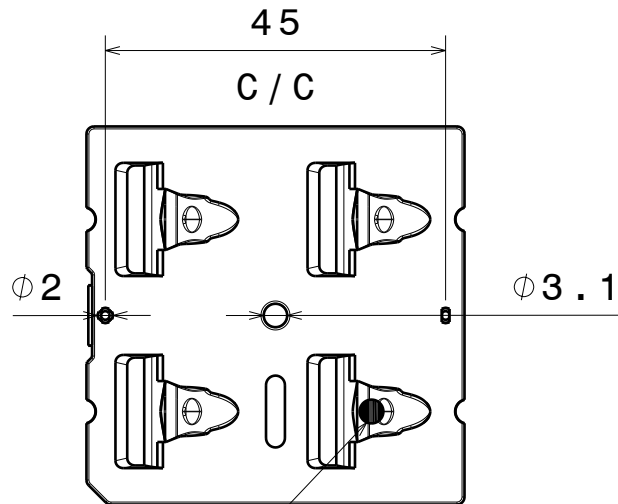

LED position Bottom view
Scale: 1:1

3

3

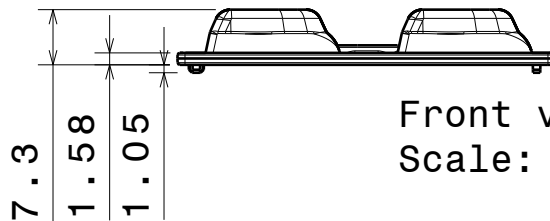

Front view
Scale: 1:1

2

2

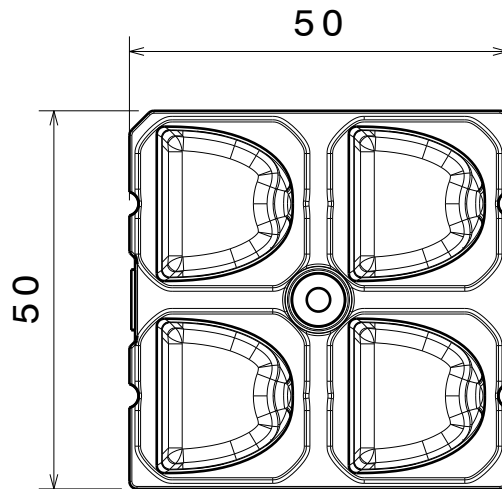

Top view
Scale: 1:1

Tolerances if not otherwise shown
According to DIN ISO 2768-1
Linear measures:
Up to 30mm class M, otherwise class C.
According to DIN ISO 2768-2
Form and position: class L



Ledil Oy
Salorankatu 10
FIN 24240 SALO
Finland

THIRD ANGLE PROJECTION:

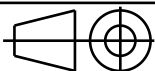

DRAWING TITLE

C12419_STRADA-2X2-A-T

This drawing is the property
of LEDiL Oy. It may not be
reproduced, copied or
communicated without a written
agreement with LEDiL Oy."

SIZE PART NUMBER

A4

C12419

SCALE 1:1 WEIGHT

-

SHEET 1/1

D

A

1

Luminaire: LEDil Oy C12419_STRADA-2X2-A-T_(XM-L2) Efficiency=94%
Lamps: 1 x Cree XM-L2 (XMLBWT-0-7B4-T30-0L-0001) 356lm @ 250mA CCT=3200K P=2.8W I=250mA

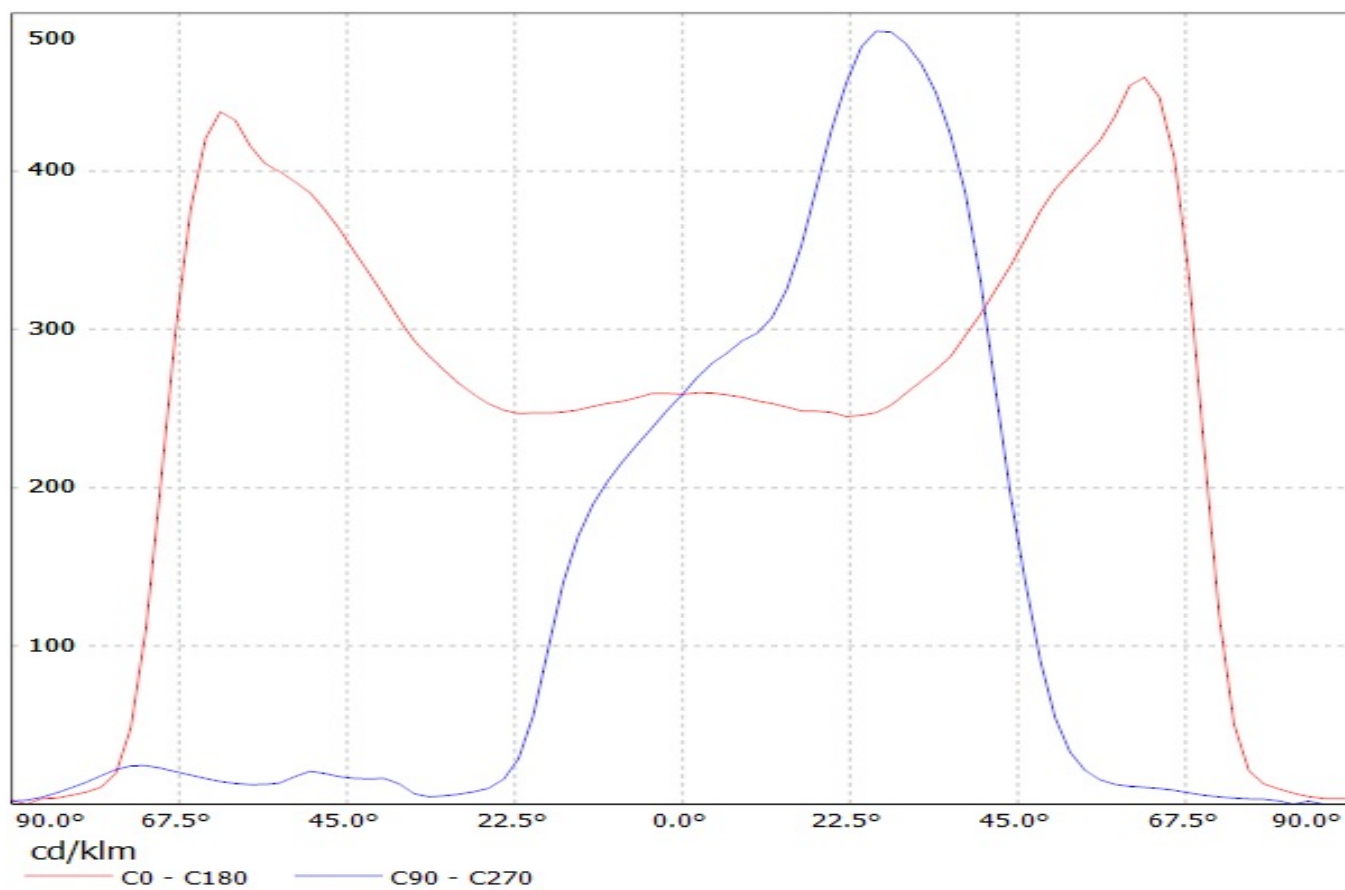

Luminaire: LEDil Oy C12419_STRADA-2X2-A-T_(XP-G2) Efficiency=94%
Lamps: 1 x Cree XP-G2 (XPGBWT-L1-000-00G51) 350lm @ 250mA CCT=7200K P=2.9W I=250mA

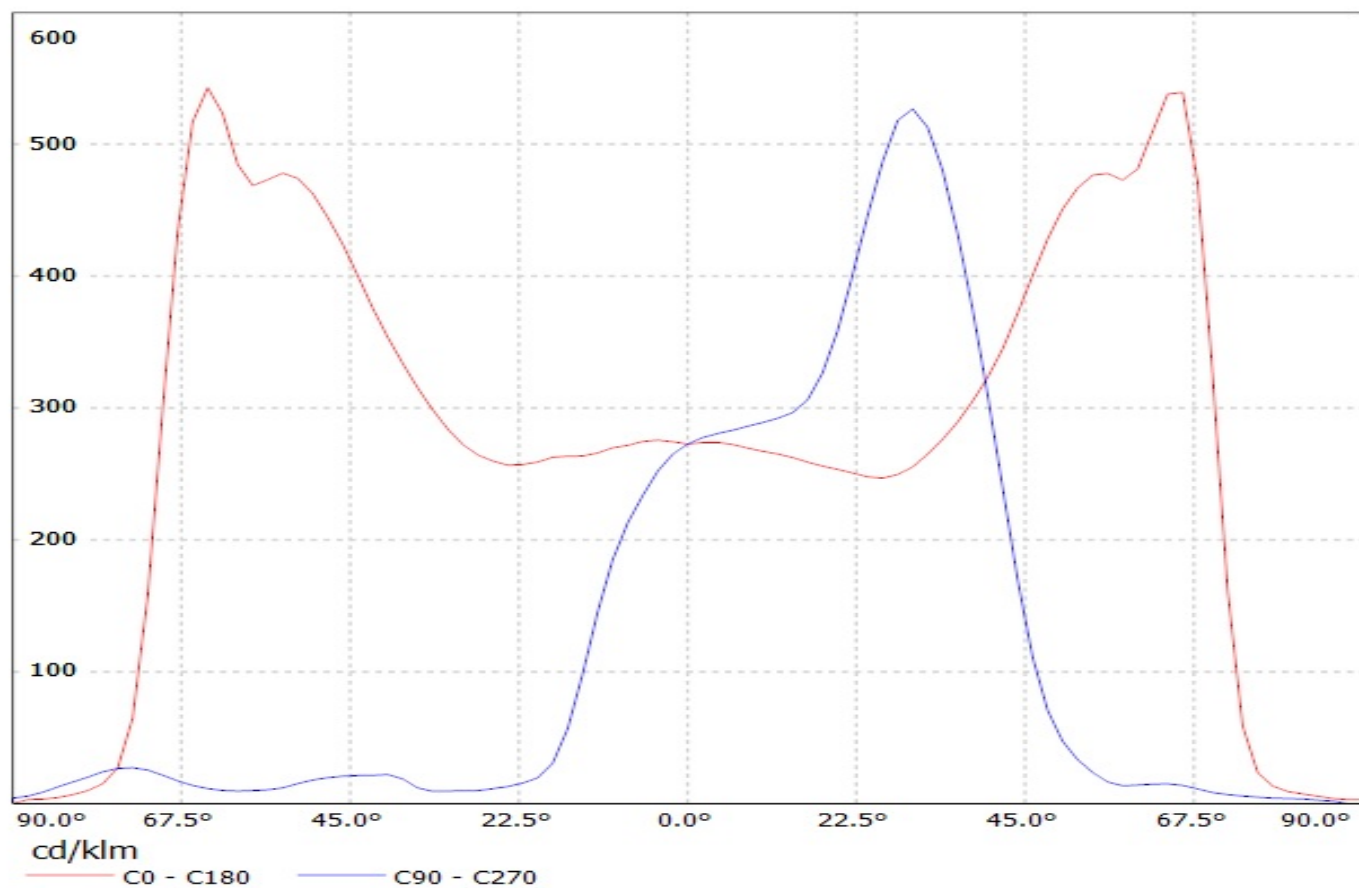

Luminaire: LEDiL Oy C12419_STRADA-2x2-A-T_(XP-L)

Lamps: 1 x CREE_XP-L_2x2_(XPLAWT-0-1B0-V40-00-0001)_517lm@250mA_CCT=7600K_P=2.79963W_I=249.9mA

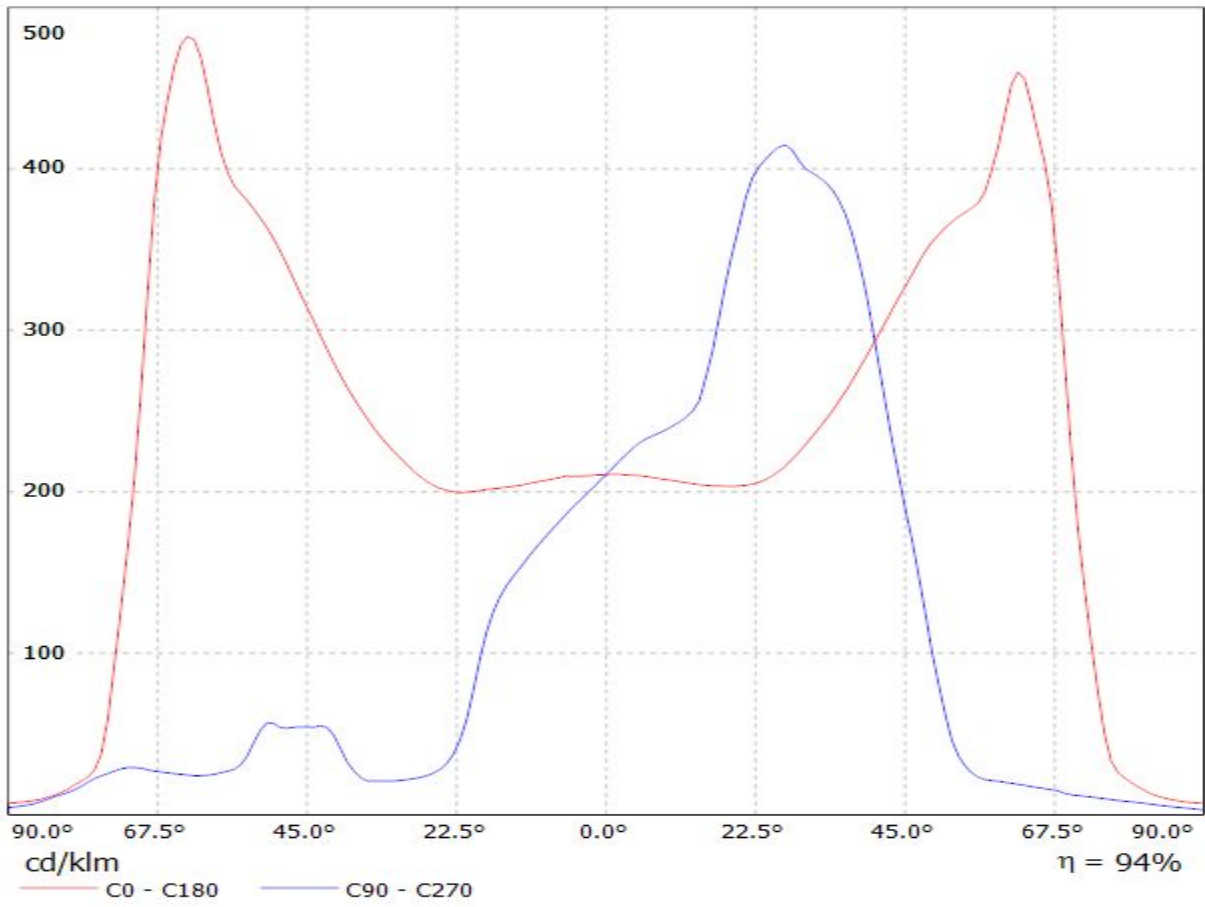

Luminaire: LEDiL Oy C12419_STRADA-2X2-A-T_(XP-L_HI)
Lamps: 1 x Cree_XP-L_HI_(2x2)_(XPLAWT-H-5A3-U60-013-0001)
_455.077lm@250mA_P=2.84011W_I=0.2499A

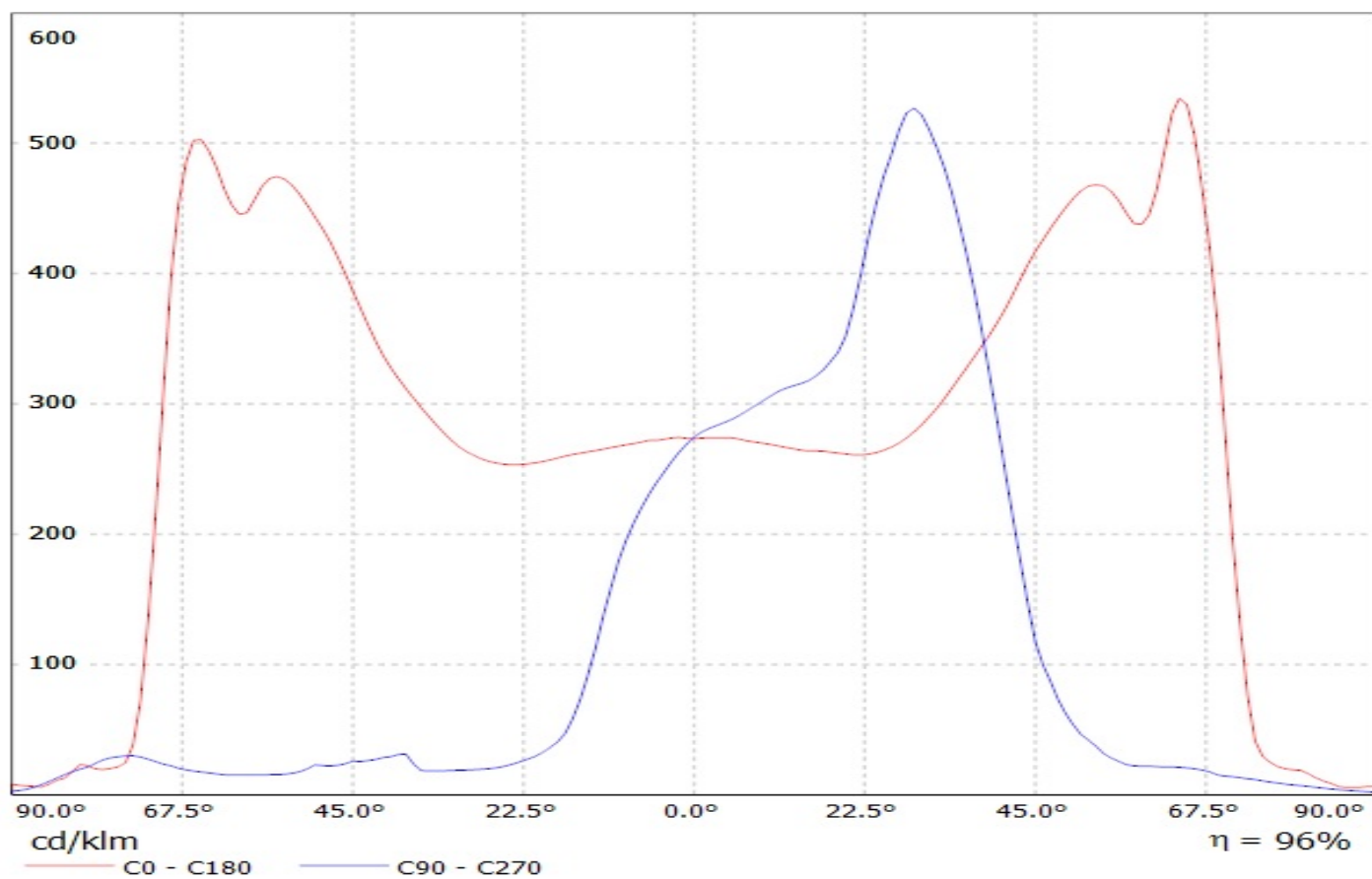

Luminaire: Ledil C12419_STRADA-2X2-A-T_(XP-L2)

Lamps: 1 x Cree_XP-L2_2x2_(XPLBWT-00-0000-000BV50E3)550.93lm@250mA_P=2.7815W_I=0.25A

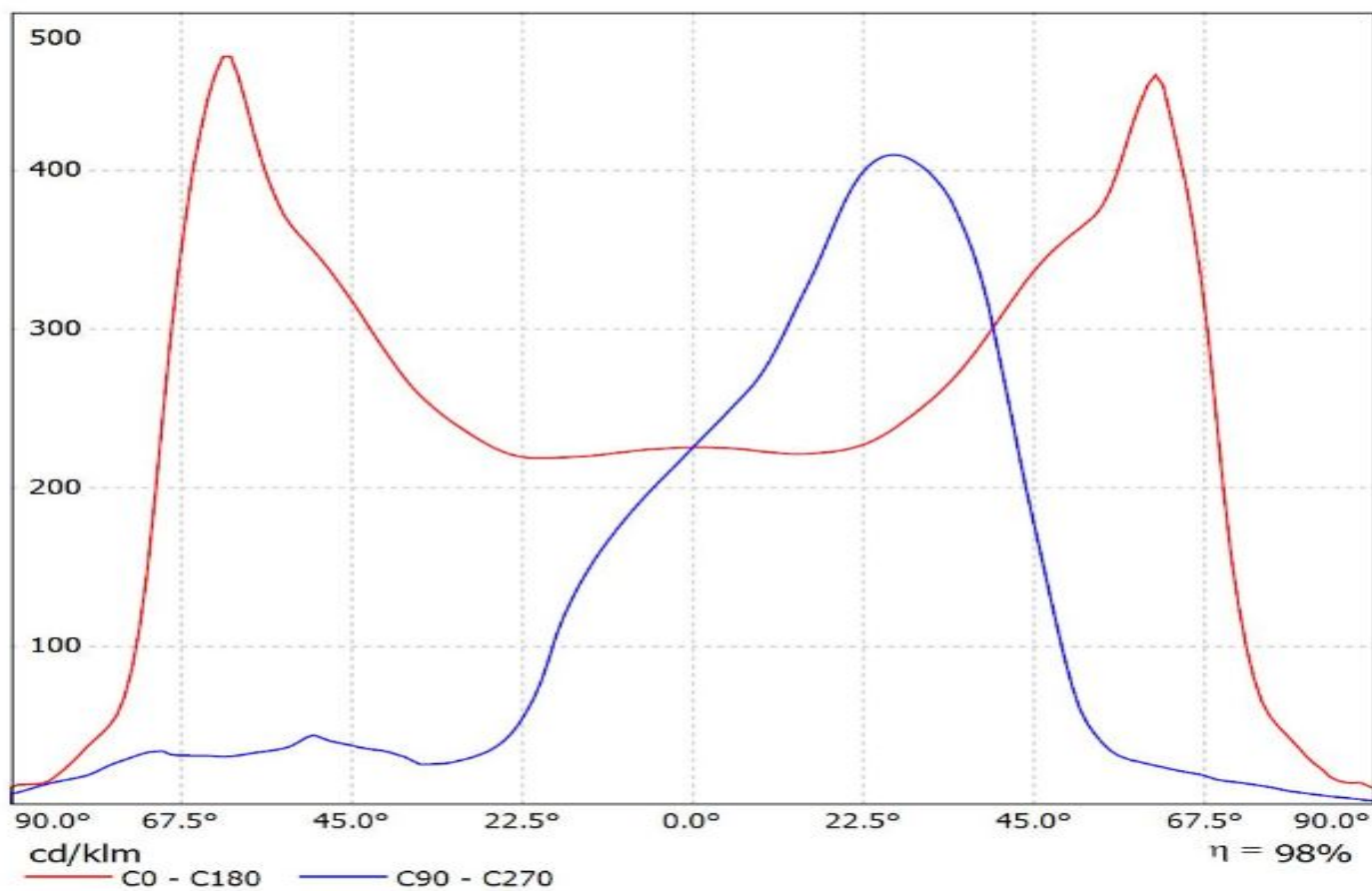

Luminaire: LEDiL Oy C12419_STRADA-2X2-A-T_(LG3535) Eff. 96,1%
Lamps: 1 x LG Ceramic 3535 PKG (372lm@250mA)

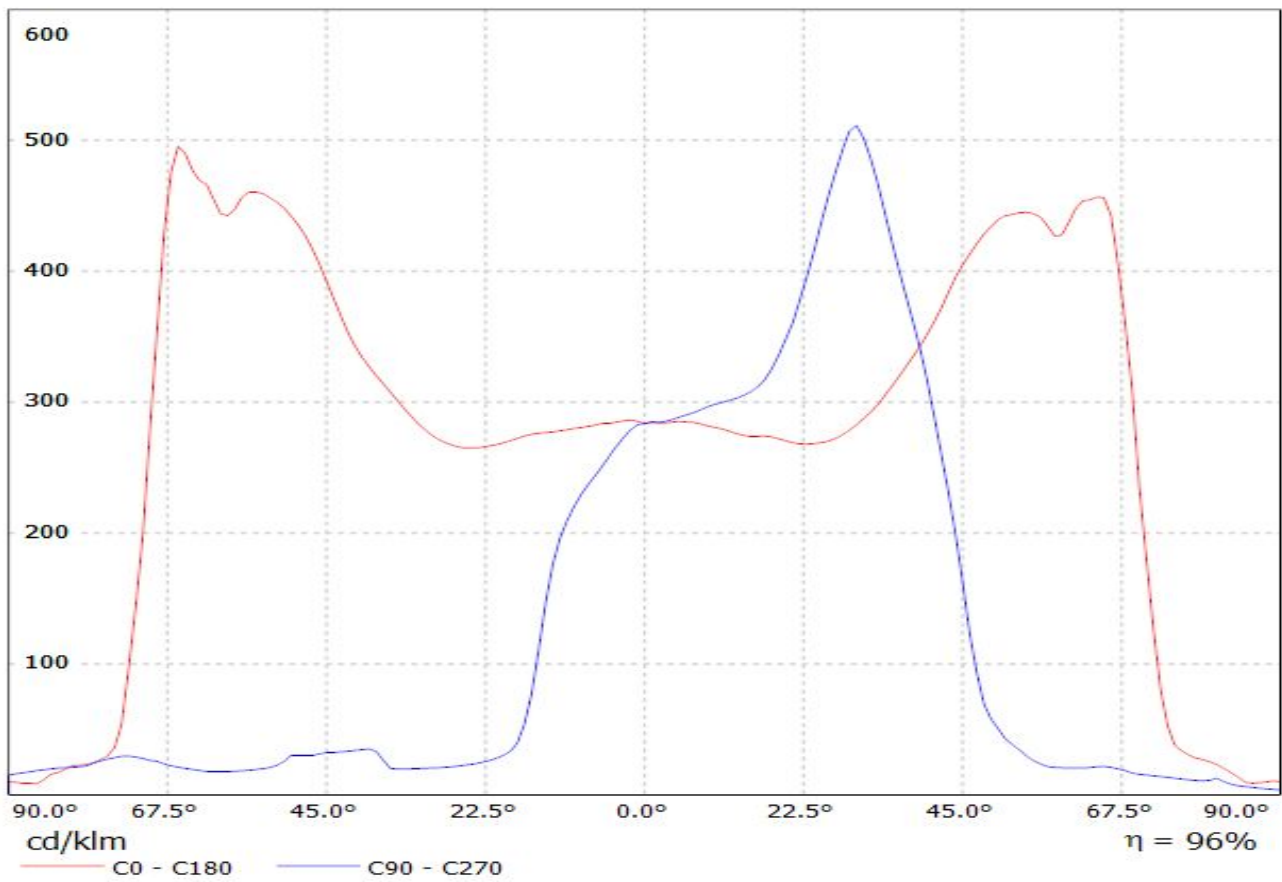

Luminaire: Ledil C12419_STRADA-2X2-A-T (H35C1)
Lamps: 1 x LG_H35C1_2x2_477.216lm@250mA_P=2.87475W_I=0.250A

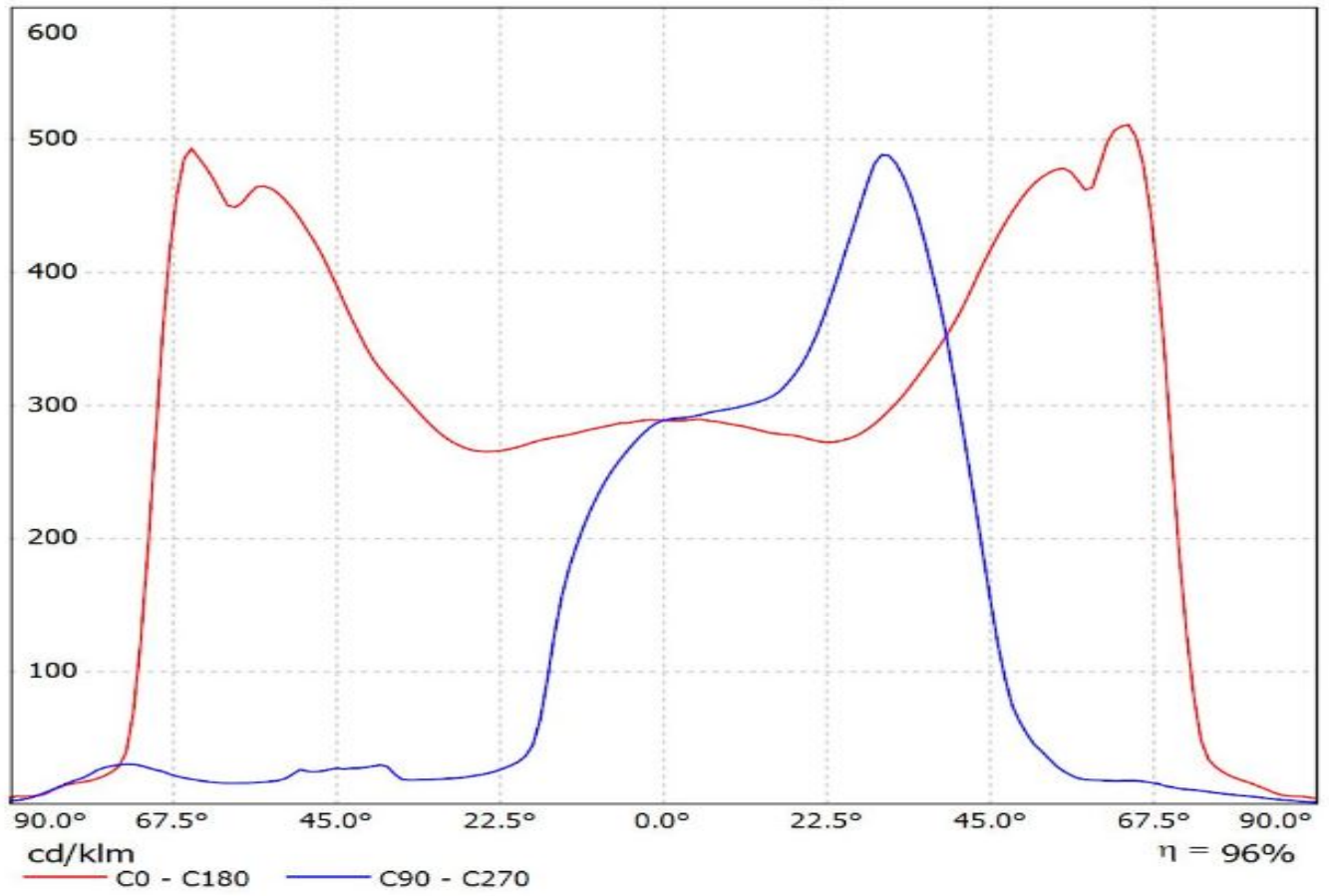

Luminaire: Ledil Oy C12419-Strada_2x2_A-T (RE-ES) Efficiency=93%
Lamps: 1 x Luxeon-Rebel-ES 250mA 500lm

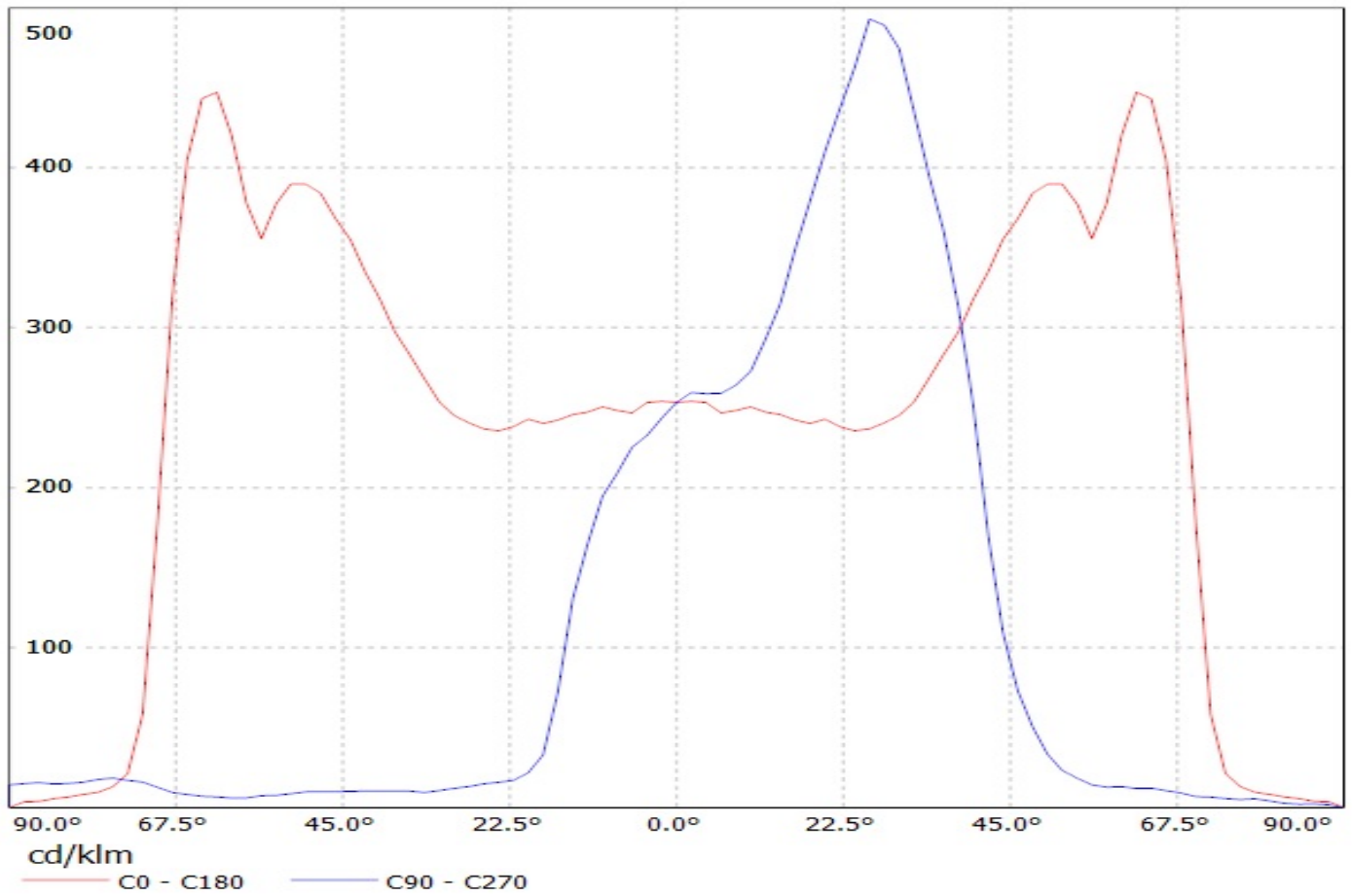

LEDiL Oy C12419_STRADA-2X2-A-T_(LUXEON_T) Eff.94.0% / LDC (Linear)

Luminaire: LEDiL Oy C12419_STRADA-2X2-A-T_(LUXEON_T) Eff.94.0%

Lamps: 1 x LUXEON_T_2x2_(LXH8-FW30-3)_296.55lm@250mA_P=2.79863W_I=249.9mA

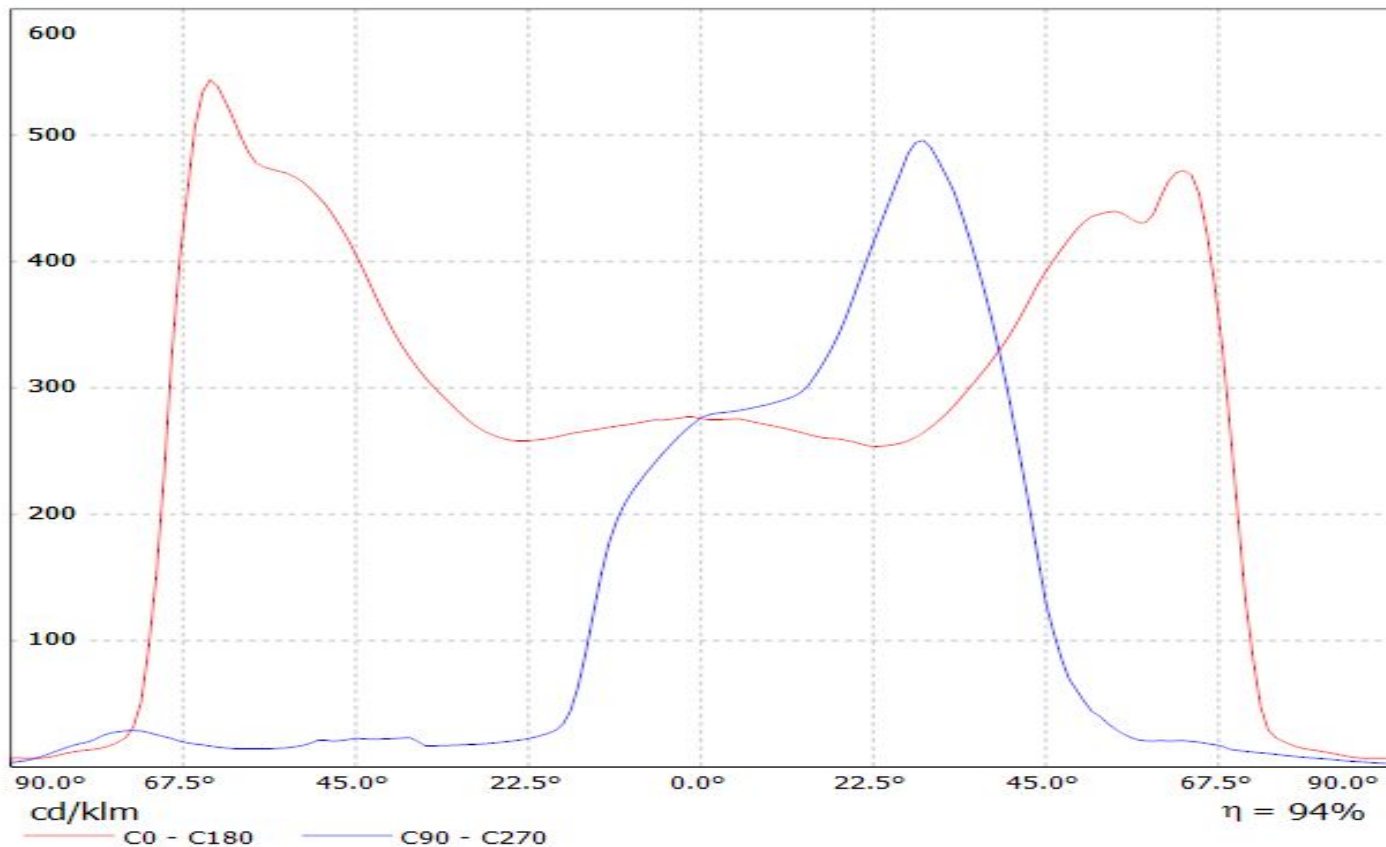

Luminaire: LEDiL Oy C12419_STRADA-2X2-A-T_(LUXEON_Q) Eff.96.4%
Lamps: 1 x LUXEON_Q_2x2_(LHQ-3080)_298.615lm@250mA_P=2.86995W_I=249.8mA

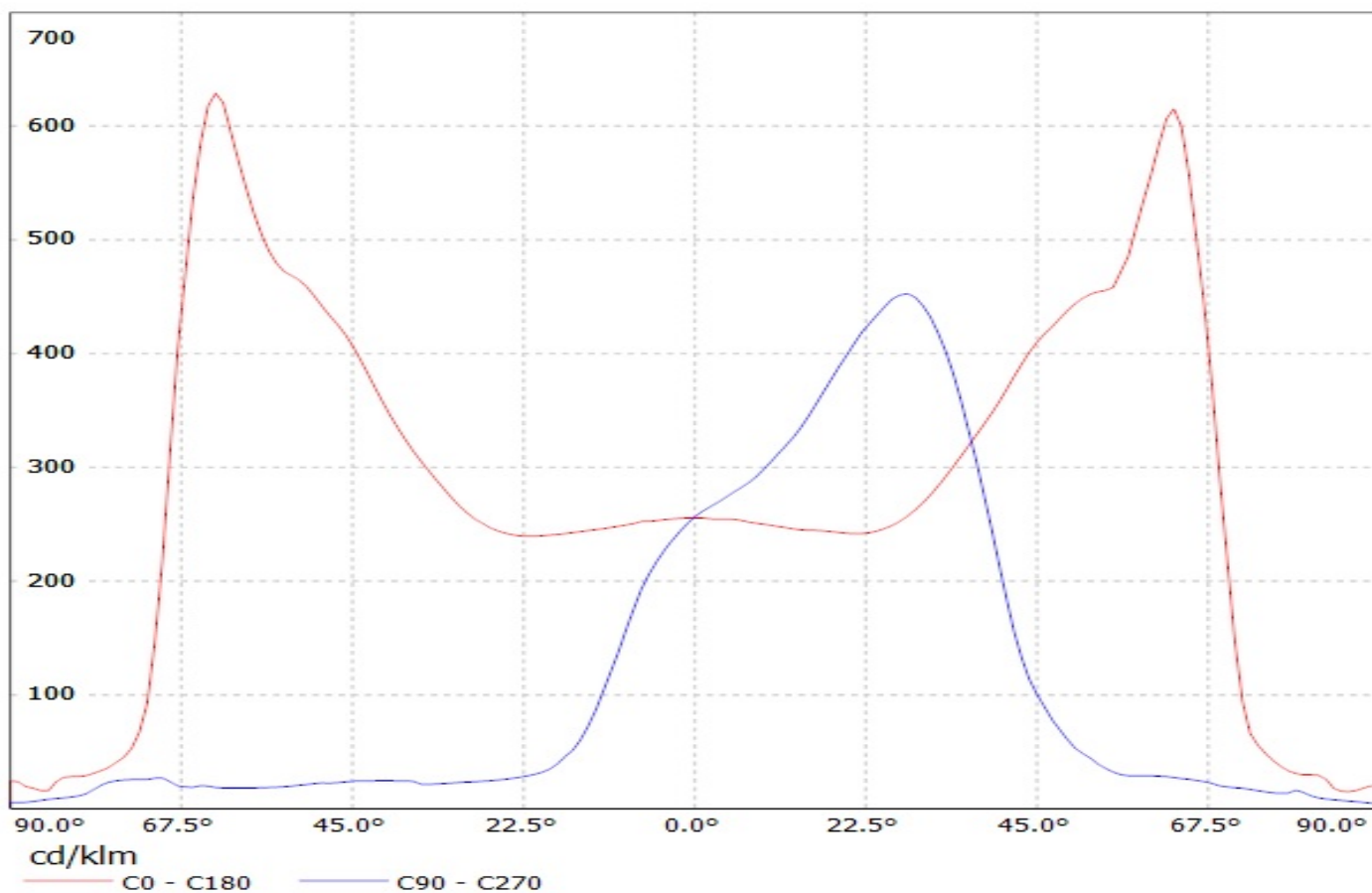

Luminaire: LEDiL Oy C12419_STRADA-2X2-A-T_(LUXEON_MZ) Eff.94.0%
Lamps: 1 x LUXEON_MZ_2x2_(LMZ7-QW57)_420.65lm@250mA_P=2.71916W_CCT=5700K_I=249.9mA

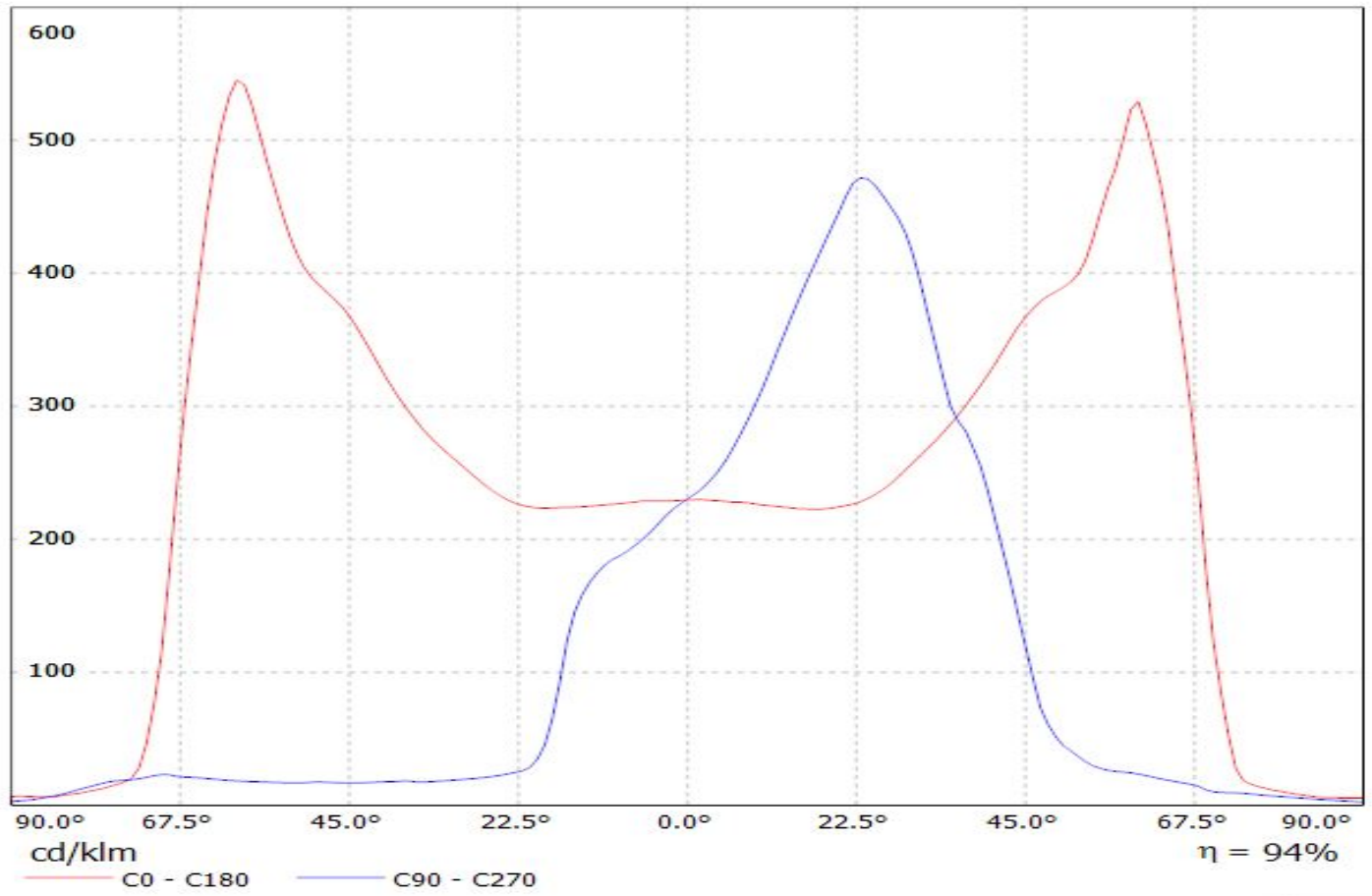

Luminaire: LEDiL Oy C12419_STRADA-2X2-A-T_(Luxeon_TX)
Lamps: 1 x Luxeon_TX_(L1T2-3585)_319.001lm@250mA_P=2.78902W_I=0.250A

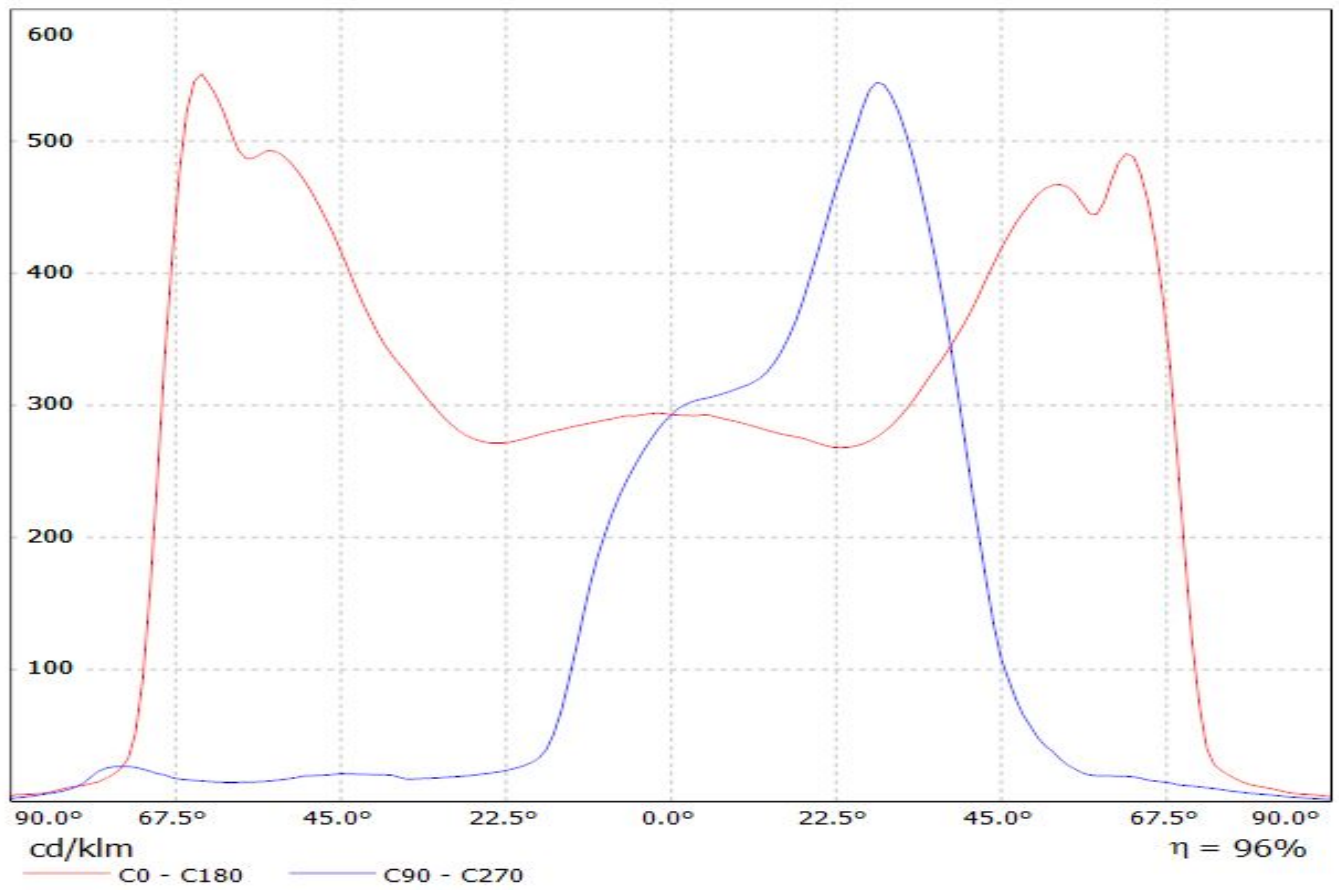

**LEDiL Oy C12419_STRADA-2x2-AT_(NICHIA_NS9x383) Eff.97.1% / LDC
(Linear)**

Luminaire: LEDiL Oy C12419_STRADA-2x2-AT_(NICHIA_NS9x383) Eff.97.1%
Lamps: 1 x NICHIA_NS9x383 (287.074lm@250mA)

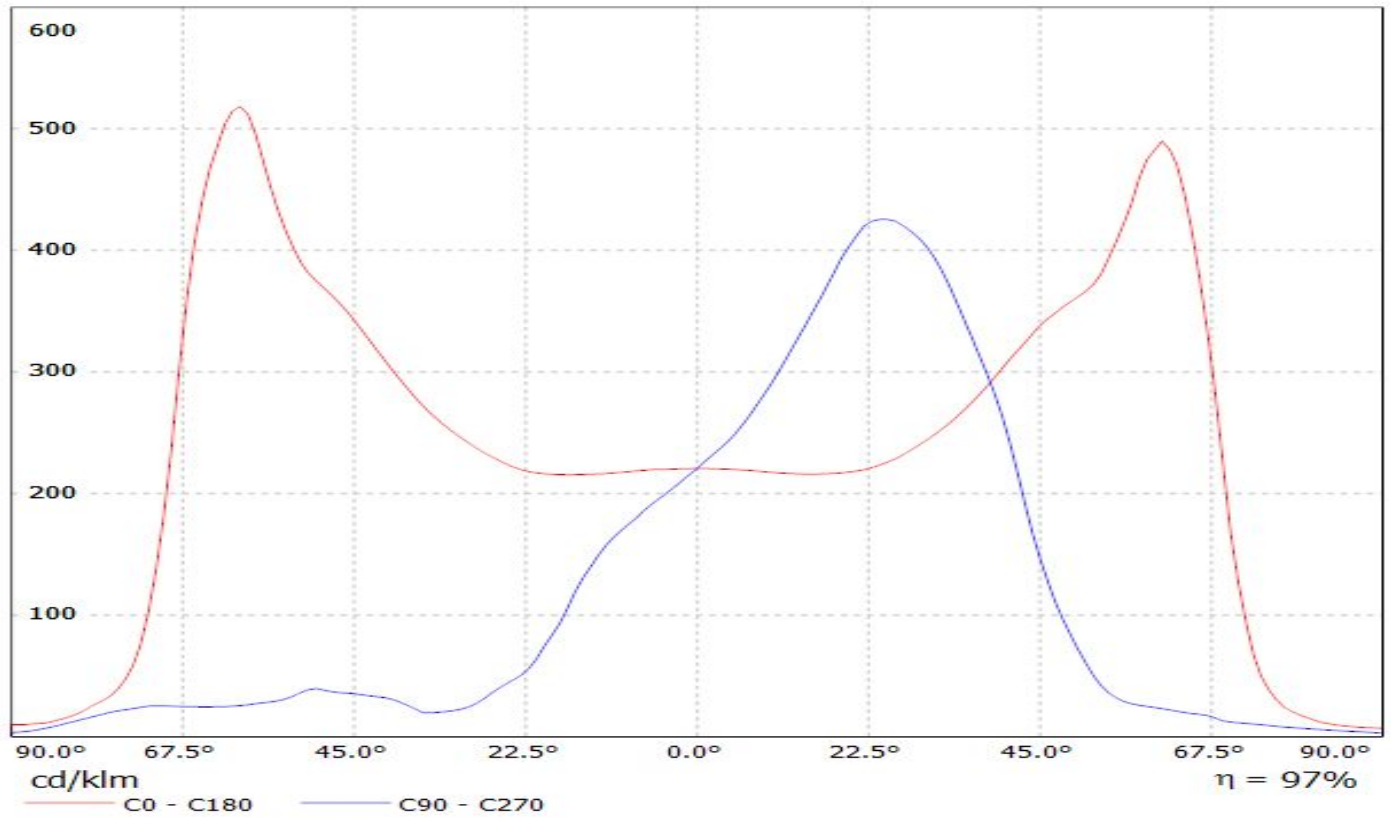

Luminaire: Ledil C12419_STRADA-2X2-A-T_(NVSW319AE)
Lamps: 1 x Nichia_NVSW319AE_(sm405D440f2L2R70)

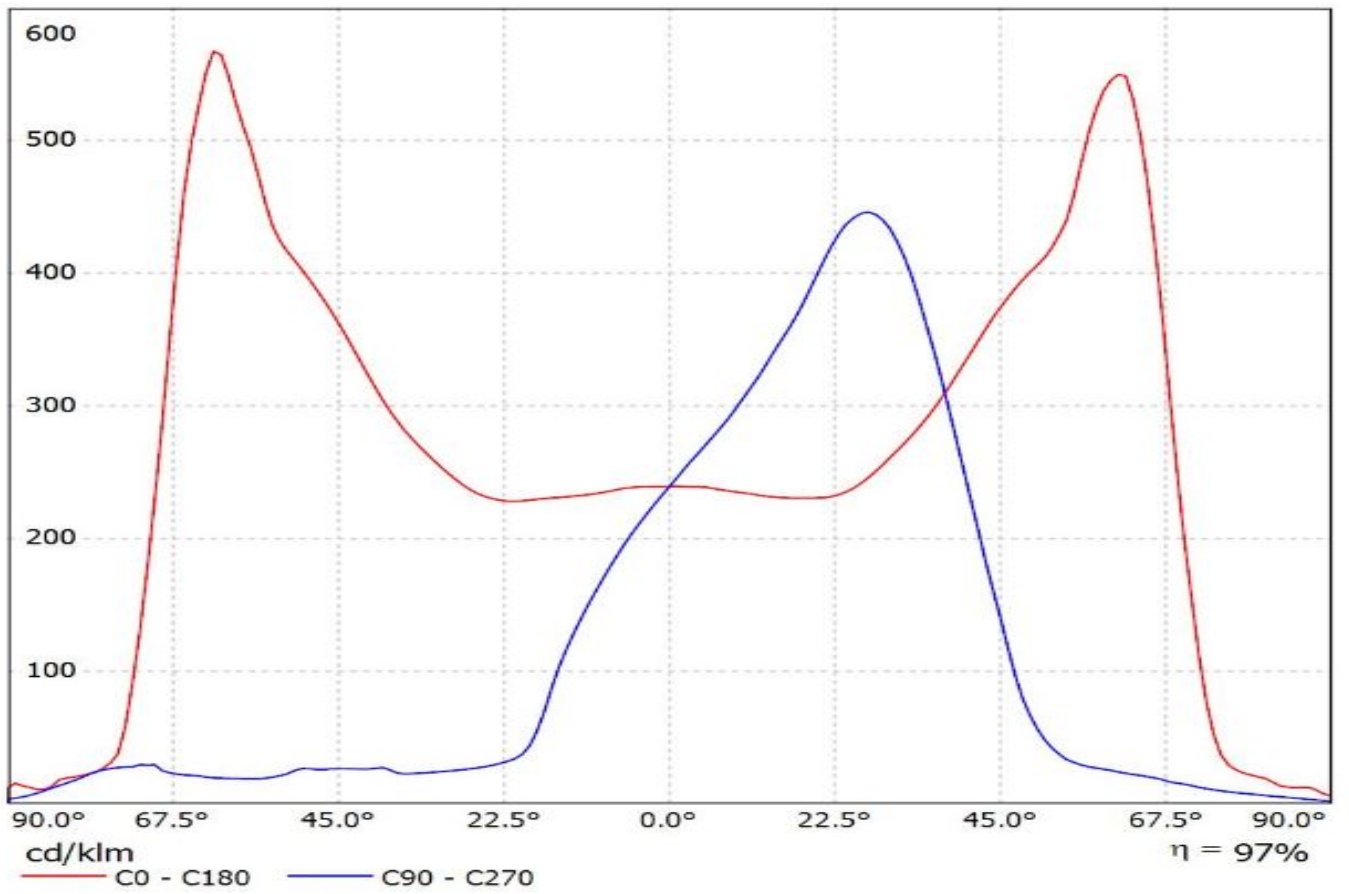

Luminaire: LEDiL Oy C12419_STRADA-2X2-A-T_(E21A)
Lamps: 1 x Nichia_E21A_452.248lm@250mA_2.805W_I=0.250A

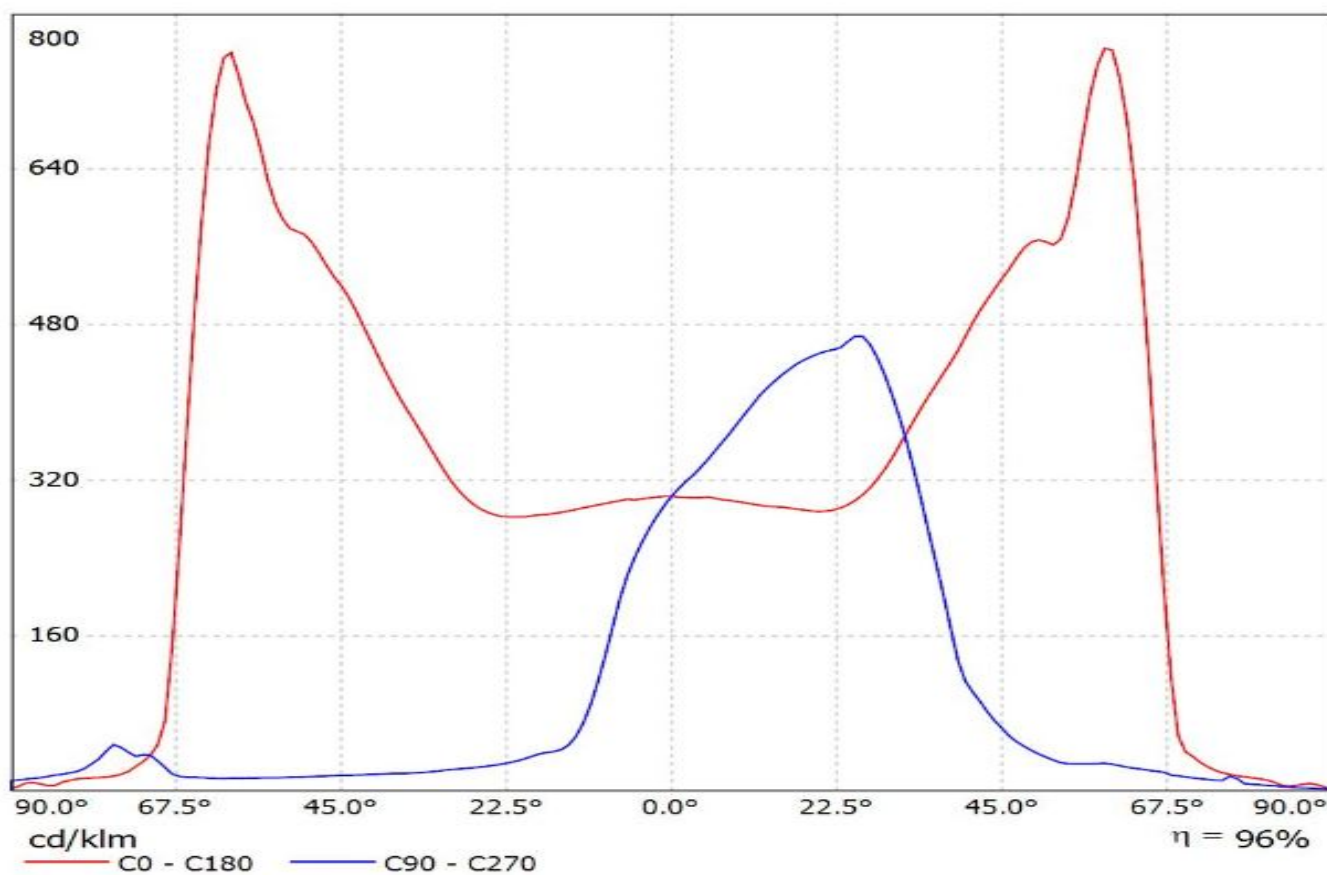

Luminaire: Ledil Oy C12419_STRADA-2X2-A-T (Osram Square PC 398lm @ 250mA) Efficiency=93%
Lamps: 1 x Osram Square PC 398lm @ 250mA

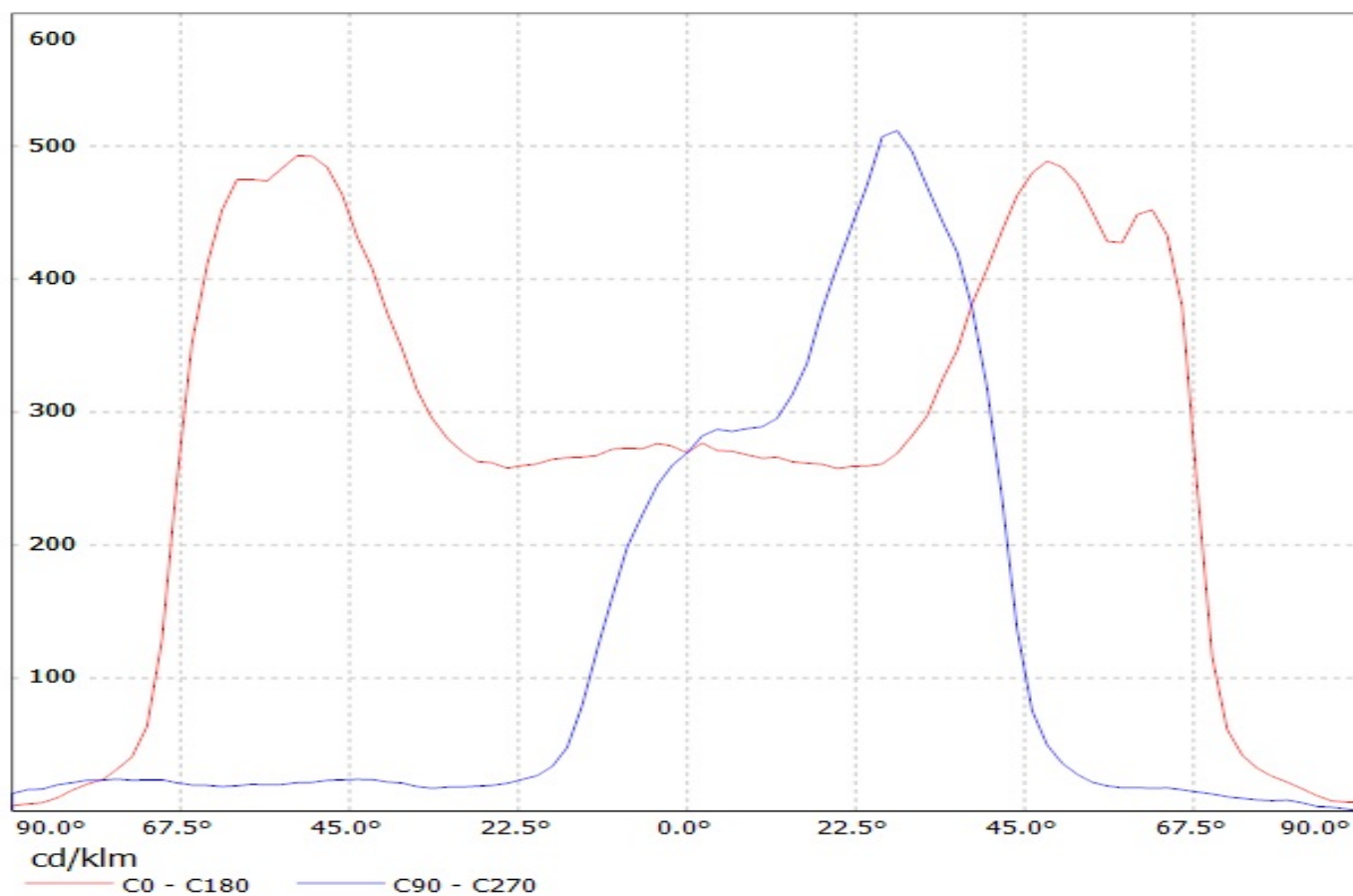

Luminaire: Ledil C12419_STRADA-2X2-A-T (square_gen3)
Lamps: 1 x Osram_square_gen3_2x2_(GW_CSSRM2.PM)_460.271lm@250mA_CCT=5000K_P=2.80625W_I=0.25A

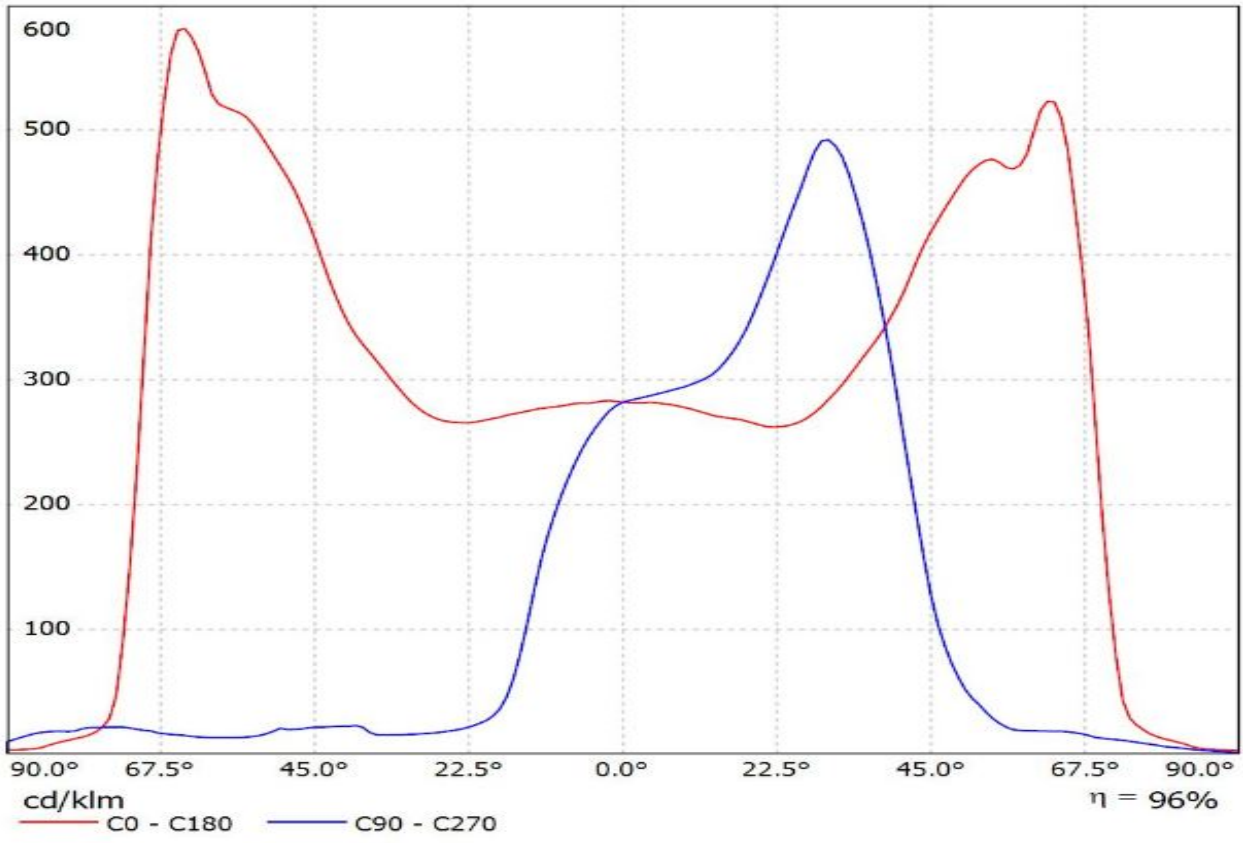

Luminaire: Ledil Oy -C12419STRADA-2X2-A-T_(DURIS_S8)_SIMULATED
Lamps: 1 x OSRAM_DURIS S8 GEN2 5050 package

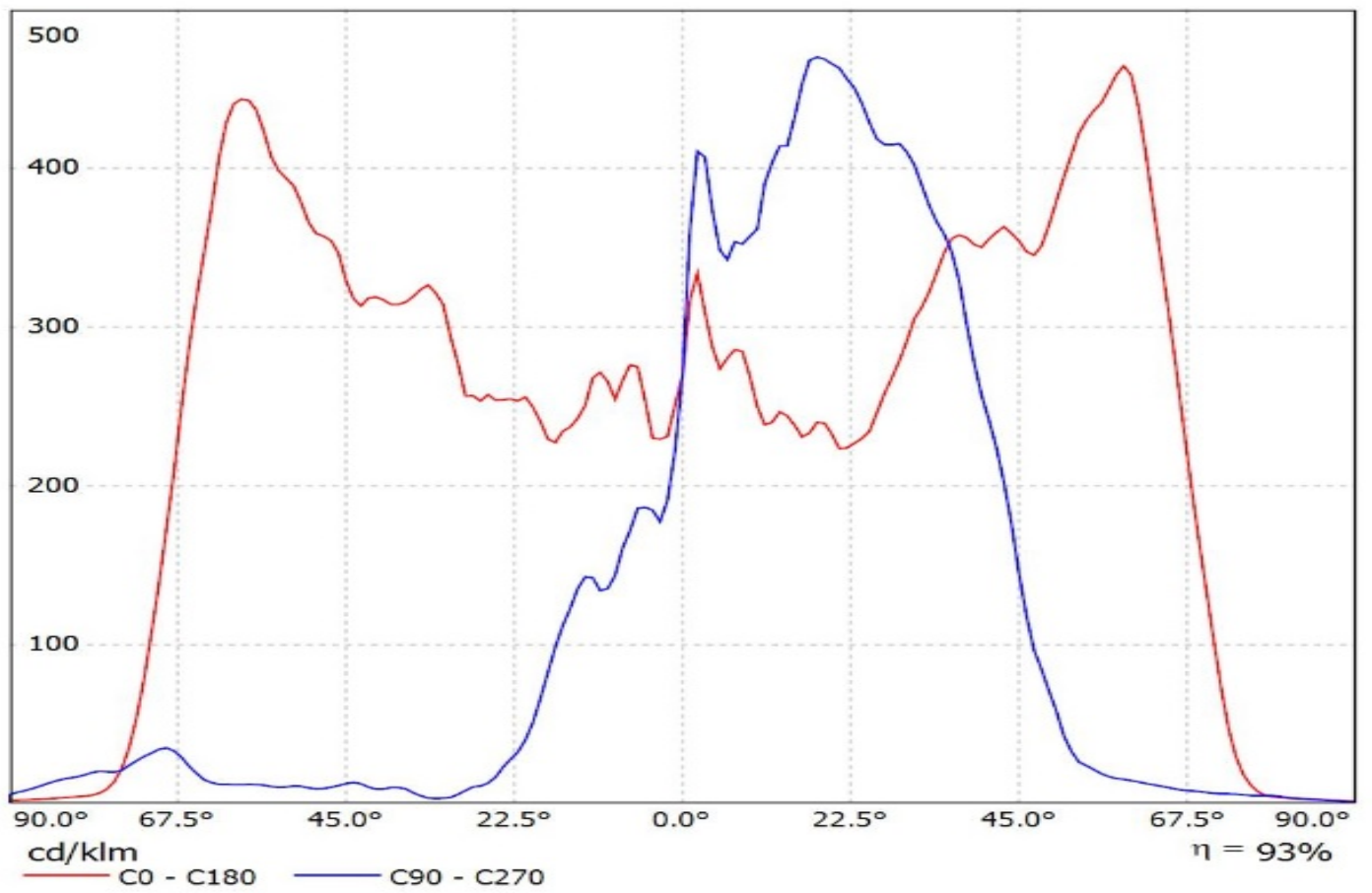

Luminaire: LEDiL Oy C12419_STRADA-2X2-A-T (Fortimo_F-Flex_2x8_740DAG3)

Lamps: 1 x Philips_Fortimo_F-Flex_2x8_740DAG3_1786.86lm@250mA_P=11.6092W_I=0.2498A

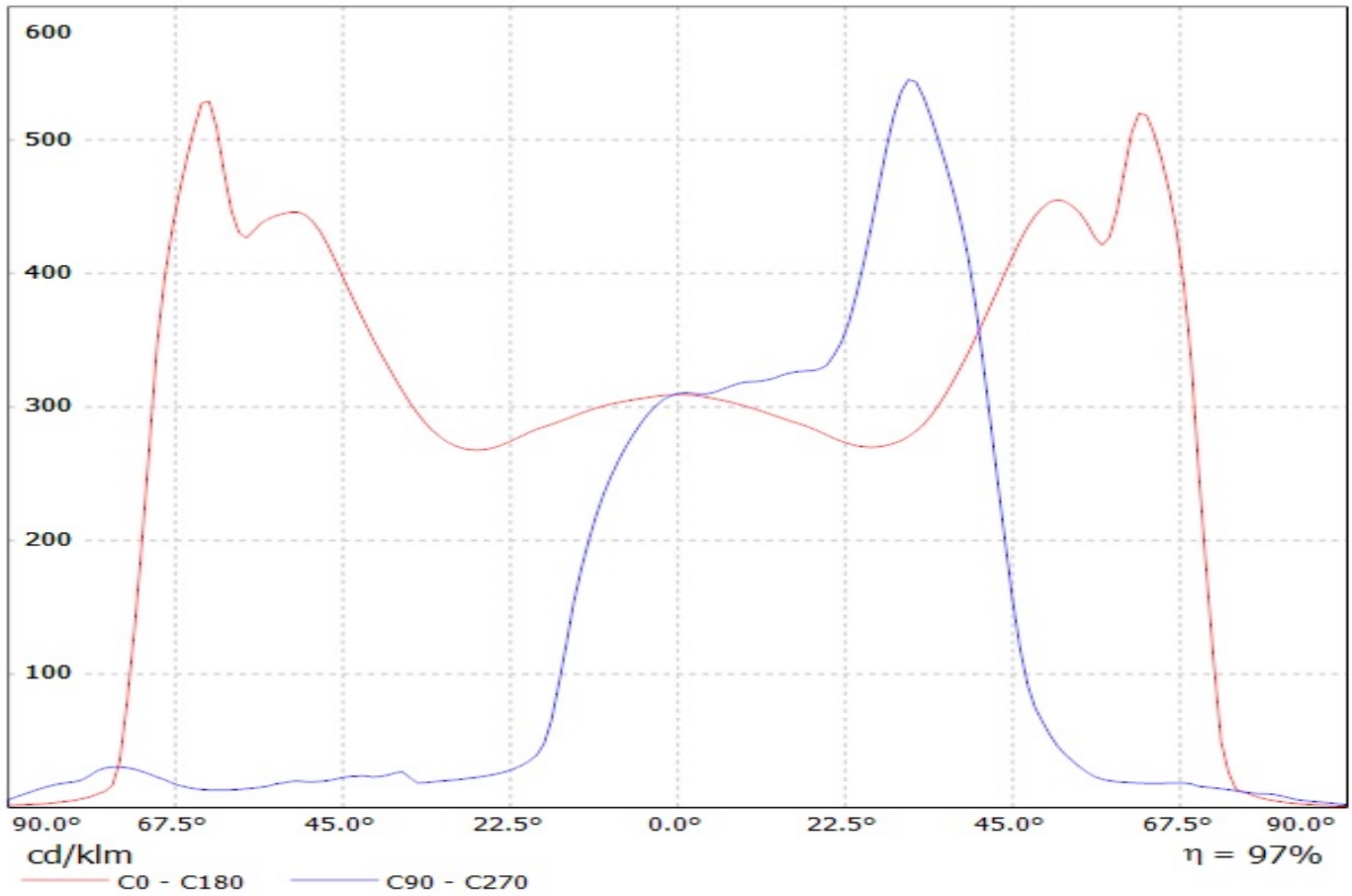

Luminaire: LEDiL Oy C12419_STRADA-2X2-A-T_(LH351B)

Lamps: 1 x SAMSUNG_LH351B_2x2_443.65lm@250mA_P=2.84311W_I=249.9mA

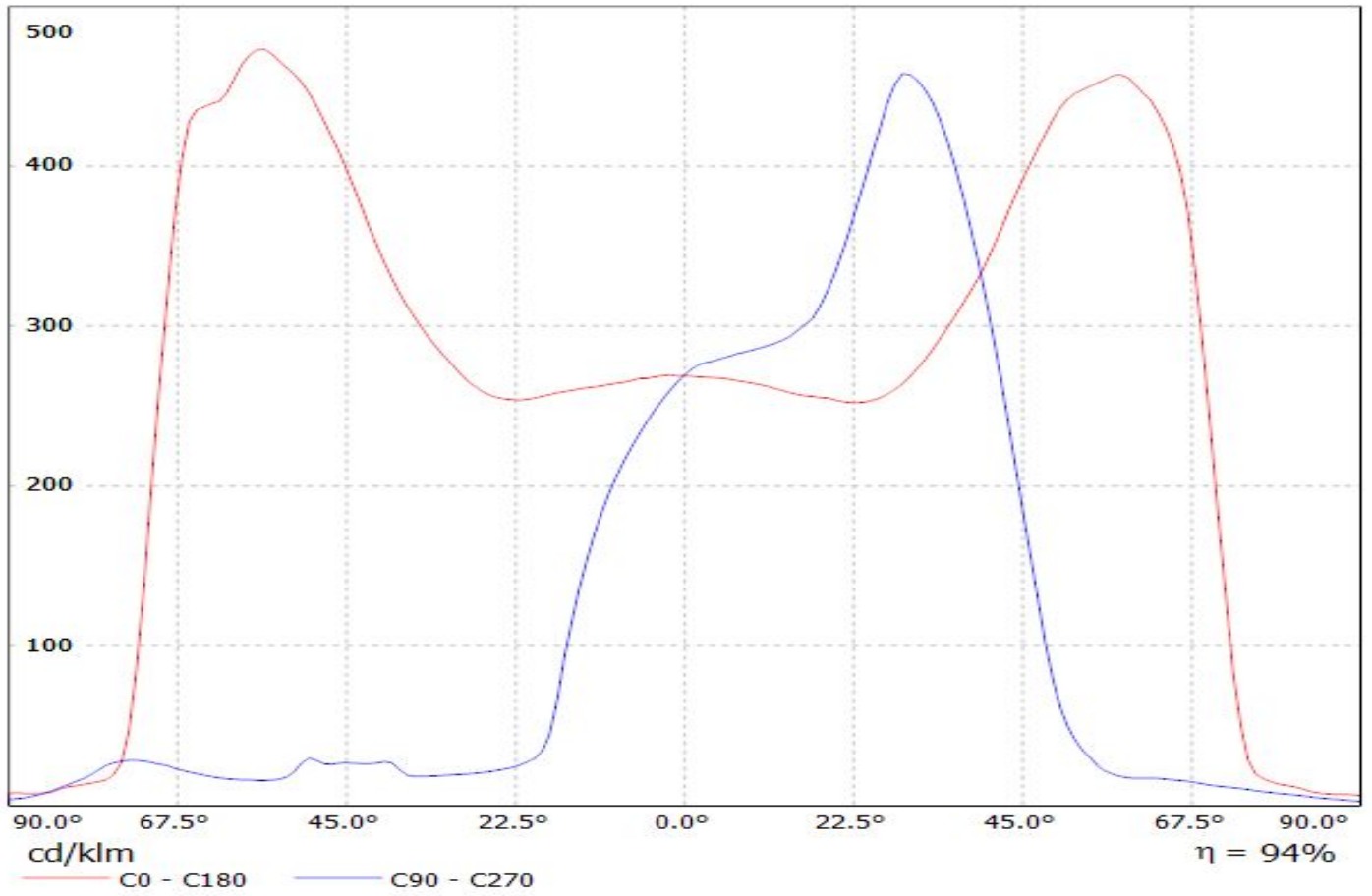

Luminaire: LEDiL Oy C12419_STRADA-2X2-A-T_(LH351Z)

Lamps: 1 x SAMSUNG_LH351Z_2x2_367.95lm@250mA_P=2.86371W_I=249.8mA

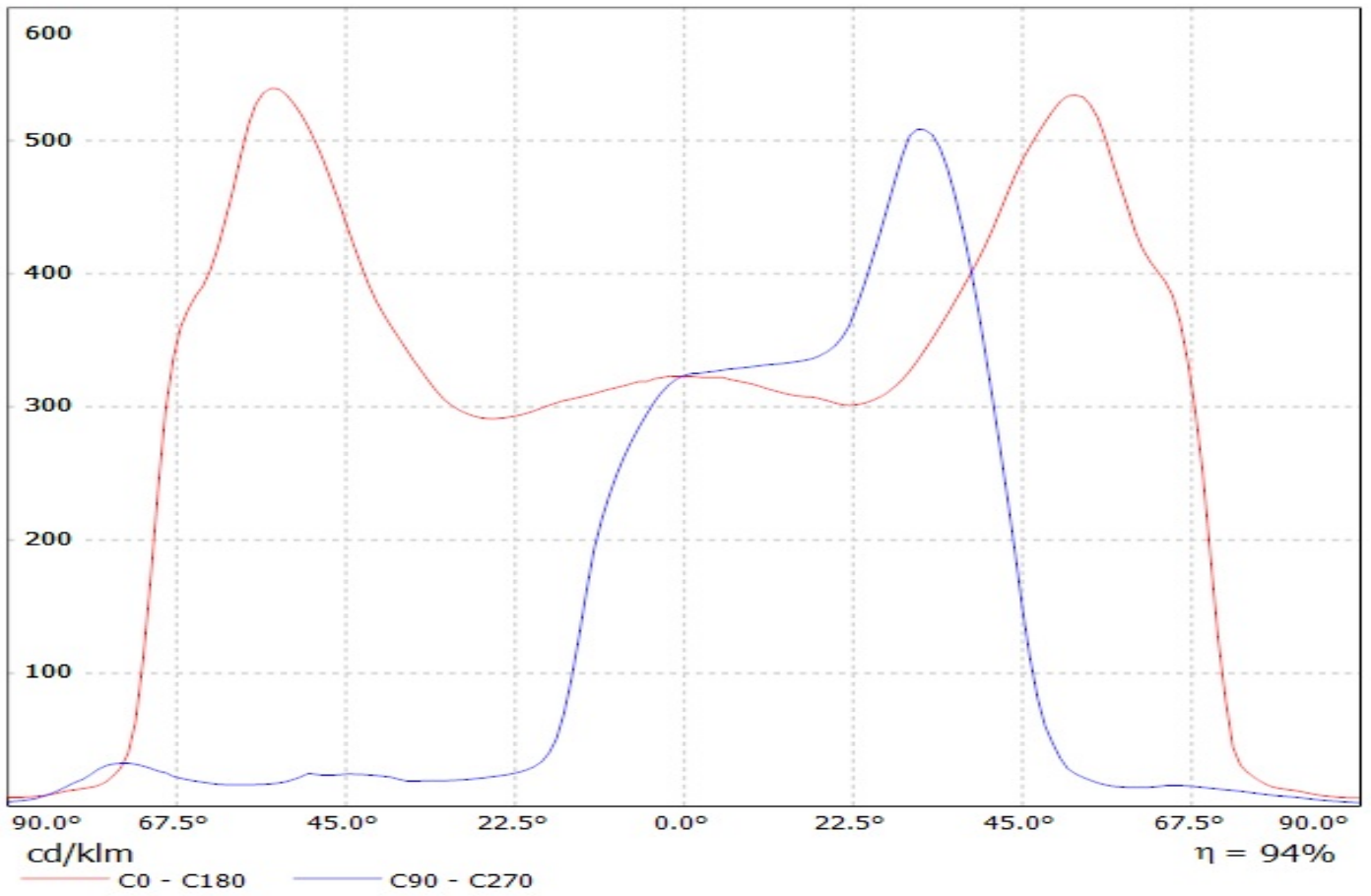

Luminaire: LEDiL Oy C12419_STRADA-2X2-A-T_(LH351D)
Lamps: 1 x Samsung_LH351D_524.264lm@250mA_P=2.7523W_I=0.250A

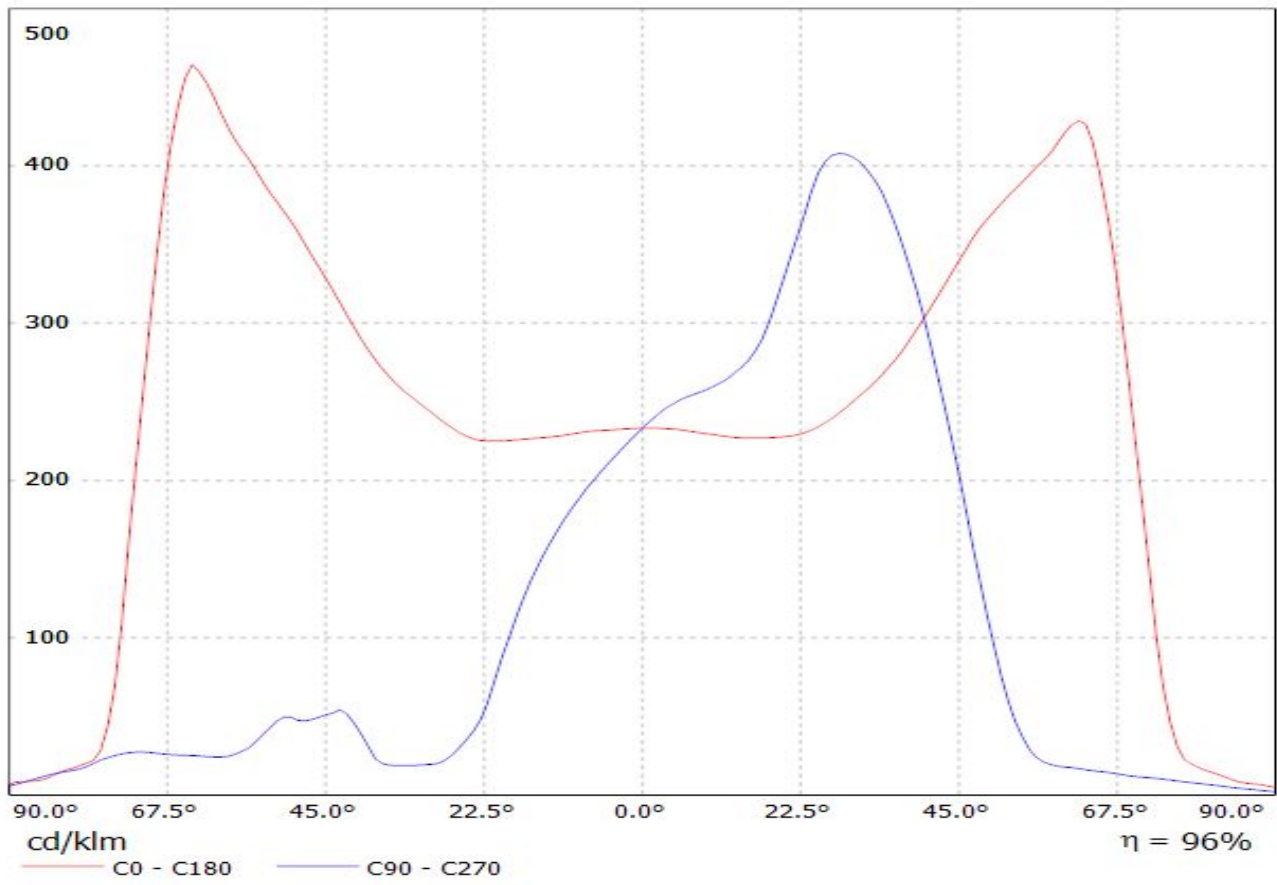

Luminaire: LEDiL Oy C12419_STRADA-2x2-A-T_(MJT4040) Eff. 94%
Lamps: 1 x SEOUL ACHRICH MJT4040 (SAW09H0A) 255lm@40mA P=2.37W I=40mA

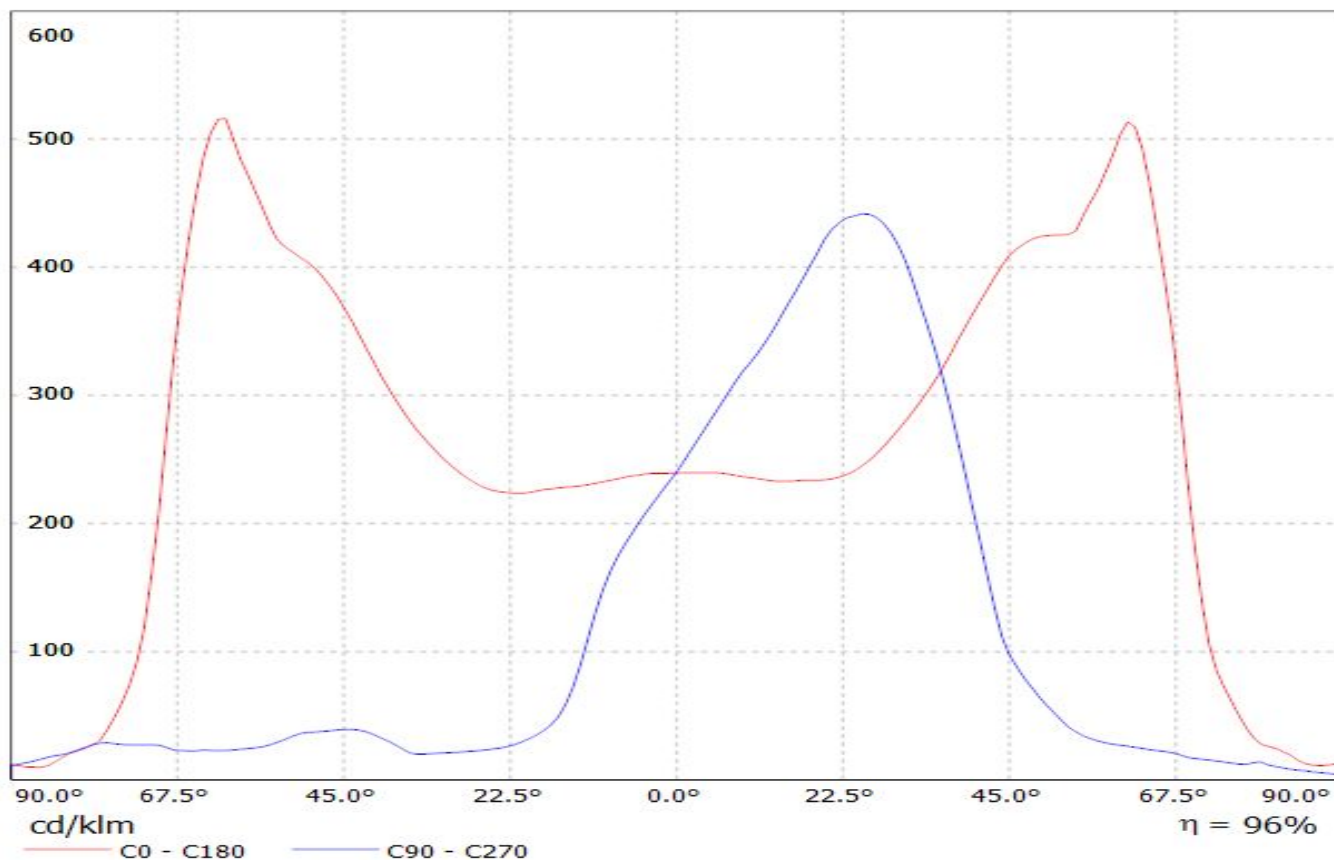

Luminaire: LEDil Oy C12419_STRADA-2X2-A-T_(Z5M1) Efficiency=94%
Lamps: 1 x Seoul Z5M1 (SZ5-M1-WN-C8) 379lm @ 250mA CCT=4600K P=2.9W I=250mA

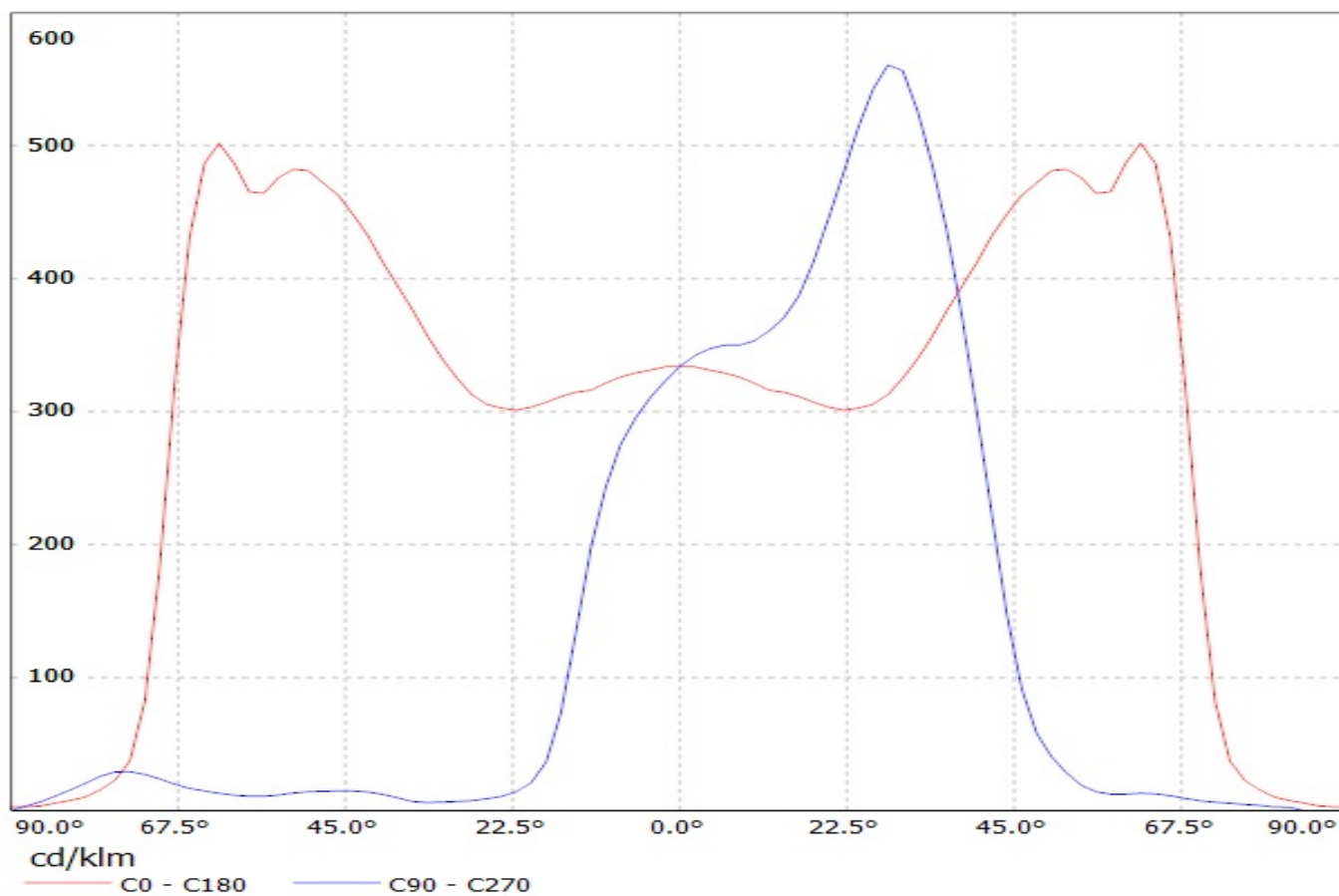

Luminaire: Ledil C12419_STRADA-2X2-A-T_(Z8Y22plus)

Lamps: 1 x Seoul_Z8Y22plus_(W6E2G)_513.996lm@250mA_P=2.754W_I=0.250A

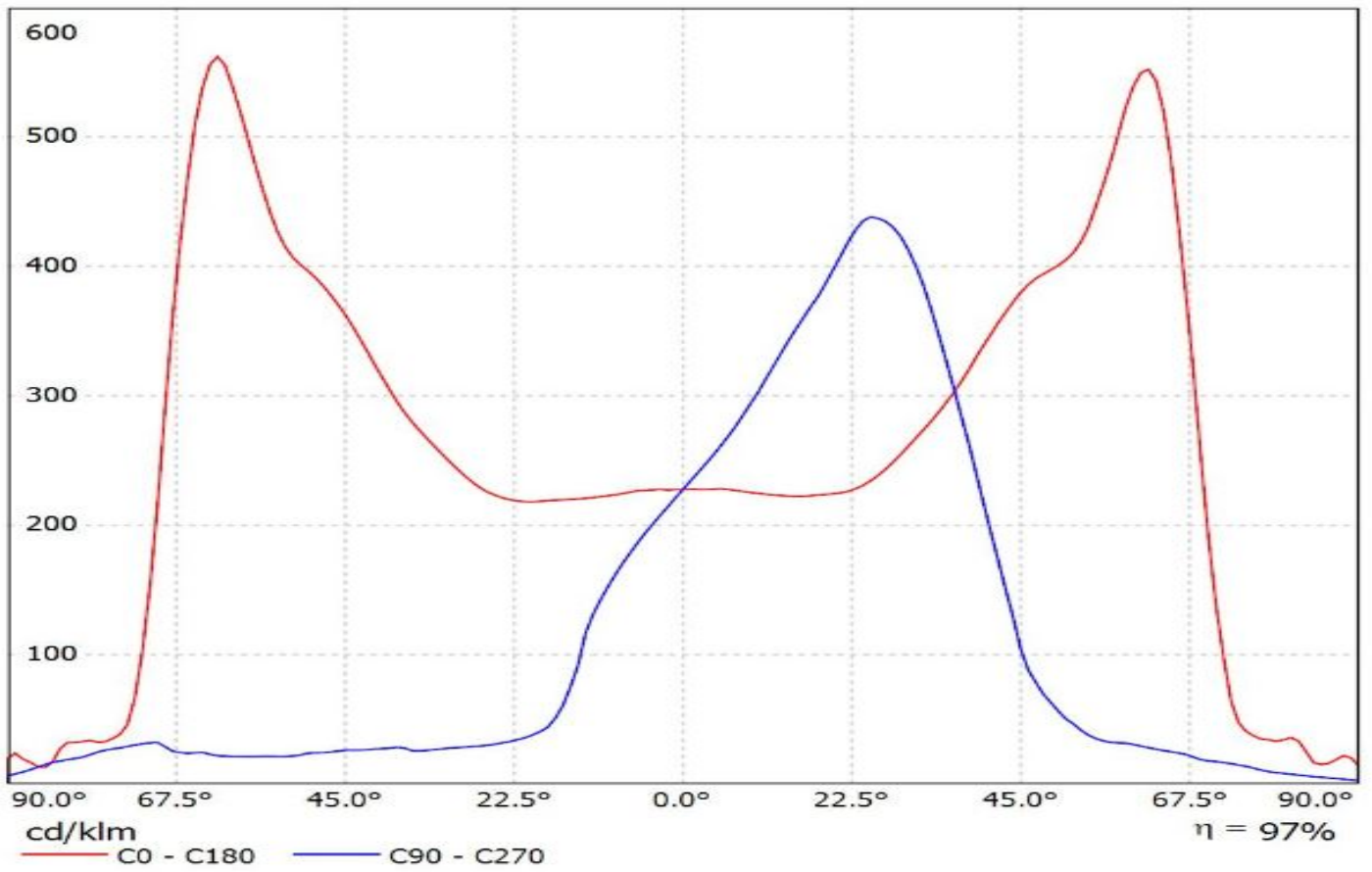

Ledil C12419_STRADA-2X2-A-T_(TL1L3) / LDC (Linear)

Luminaire: Ledil C12419_STRADA-2X2-A-T_(TL1L3)

Lamps: 1 x Toshiba_TL1L3_2x2_(TL1L3-NW1.L)_387.773lm@250mA_CCT=5000K_P=2.829W_I=0.25A

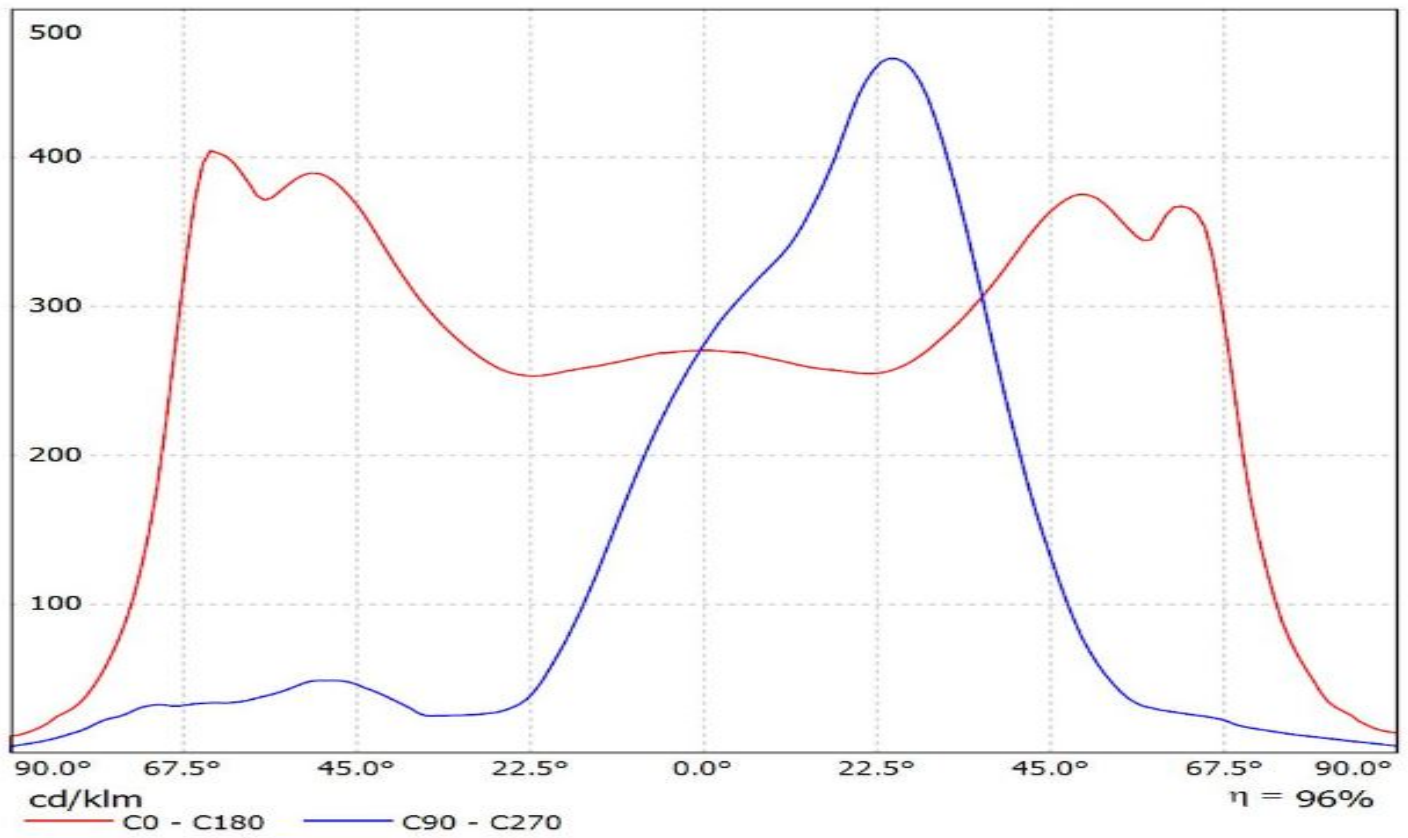

Ledil C12419_STRADA-2X2-A-T_(TL1L4) / LDC (Linear)

Luminaire: Ledil C12419_STRADA-2X2-A-T_(TL1L4)

Lamps: 1 x Toshiba_TL1L4_2x2_(TL1L4-DW0)_472.639lm@250mA_CCT=6500K_P=2.9W_I=0.25A

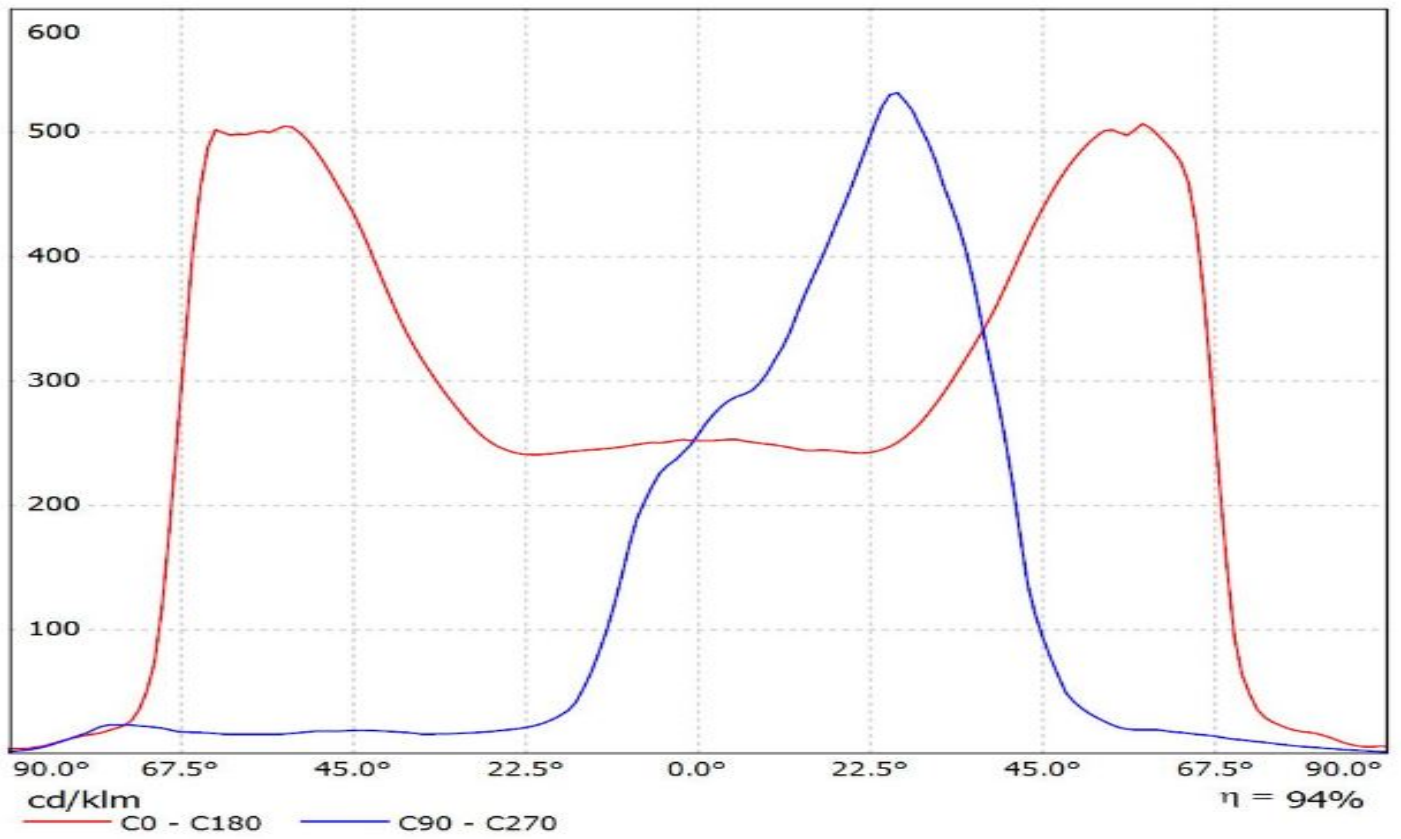

Luminaire: LEDiL Oy C12419_STRADA-2X2-A-T (Tridonic Module_RLE_G1)
Lamps: 1 x Tridonic_Module_RLE_G1_4576.03lm@700mA_P=32.0681W_I=0.700A

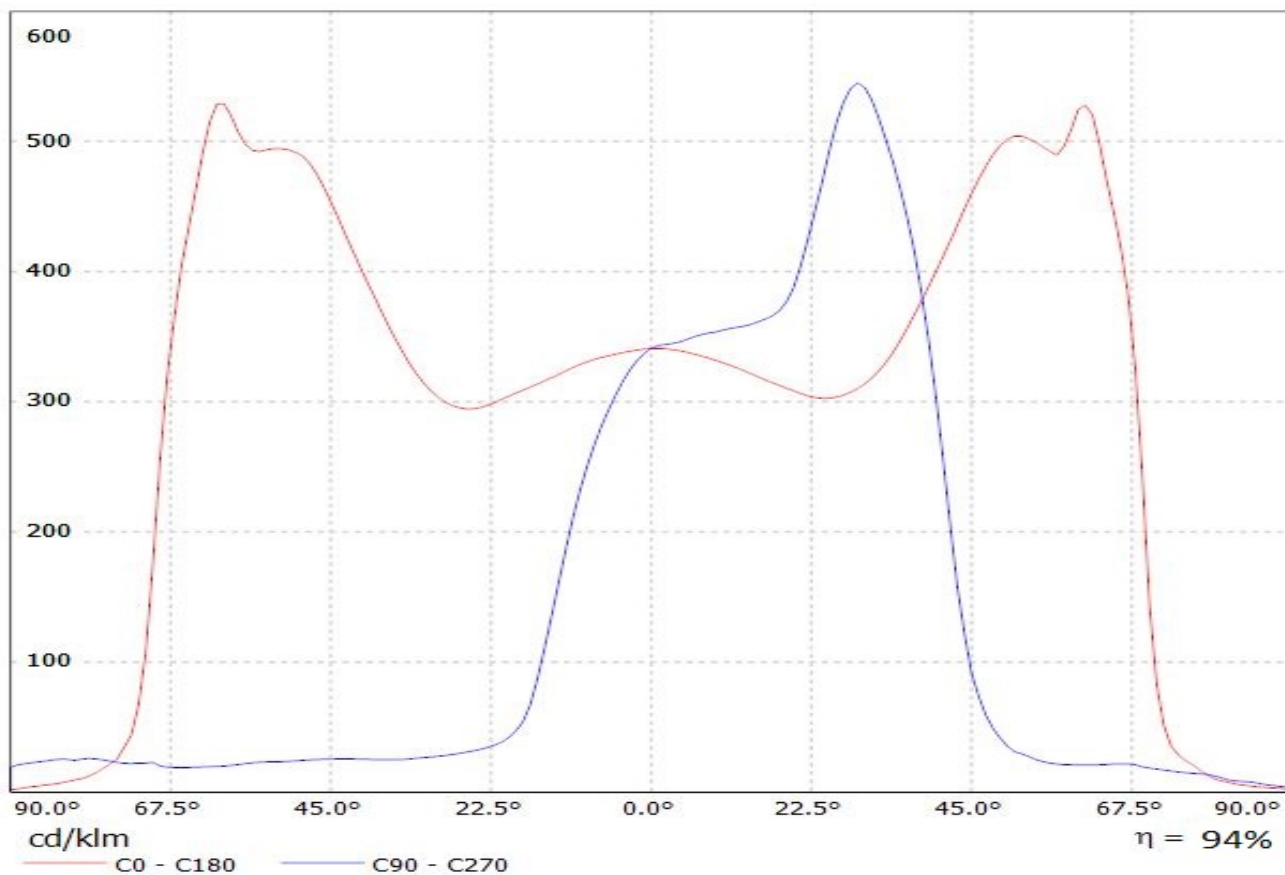

Luminaire: LEDiL Oy C12419_STRADA-2X2-A-T (Tridonic Module_RLE_G1)
Lamps: 1 x Tridonic_Module_RLE_G1_4576.03lm@700mA_P=32.0681W_I=0.700A

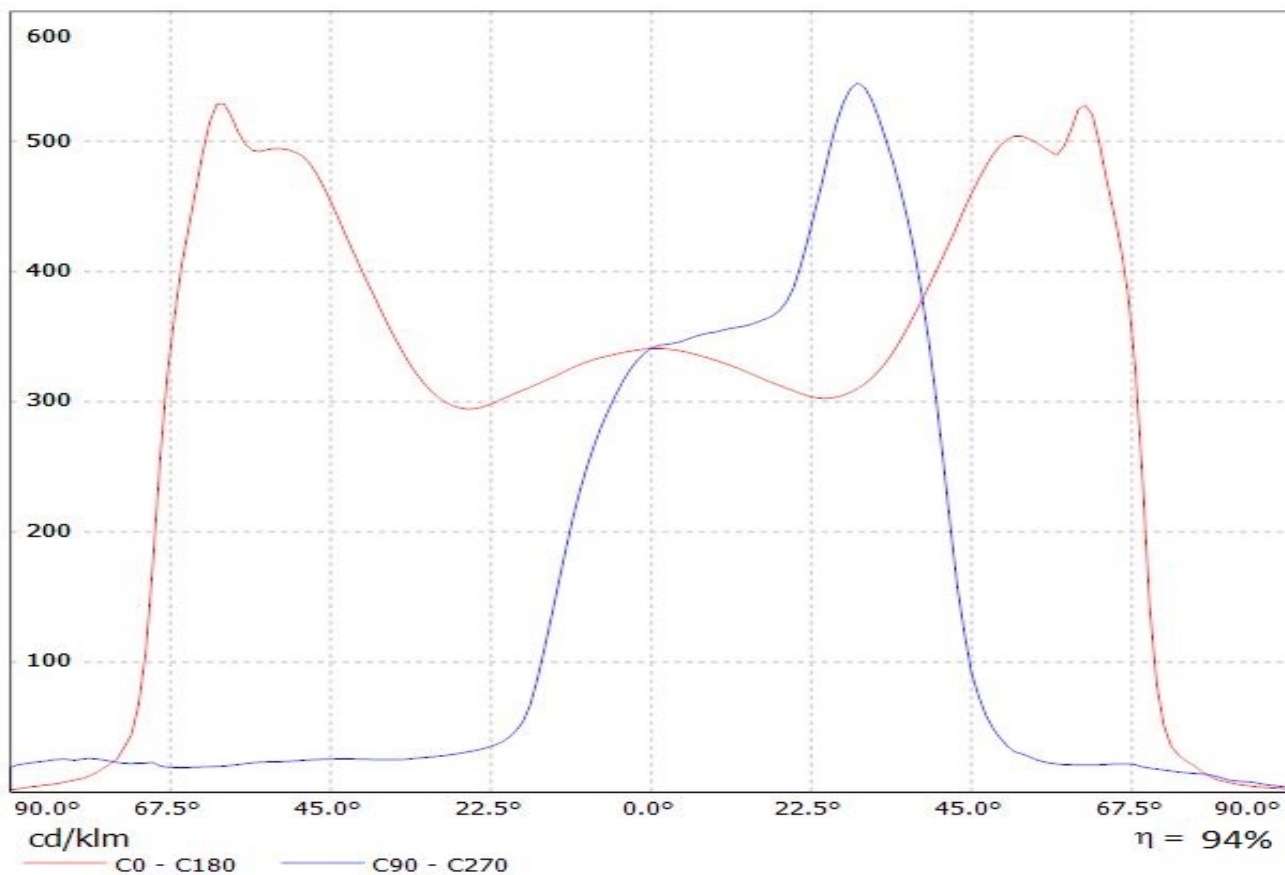

Luminaire: LEDiL Oy C12419_STRADA-2X2-A-T_(Tridonic_Module_RLE_G1)
Lamps: 1 x Tridonic_Module_RLE_G1_2288lm@700mA_P=16W_I=0.700A

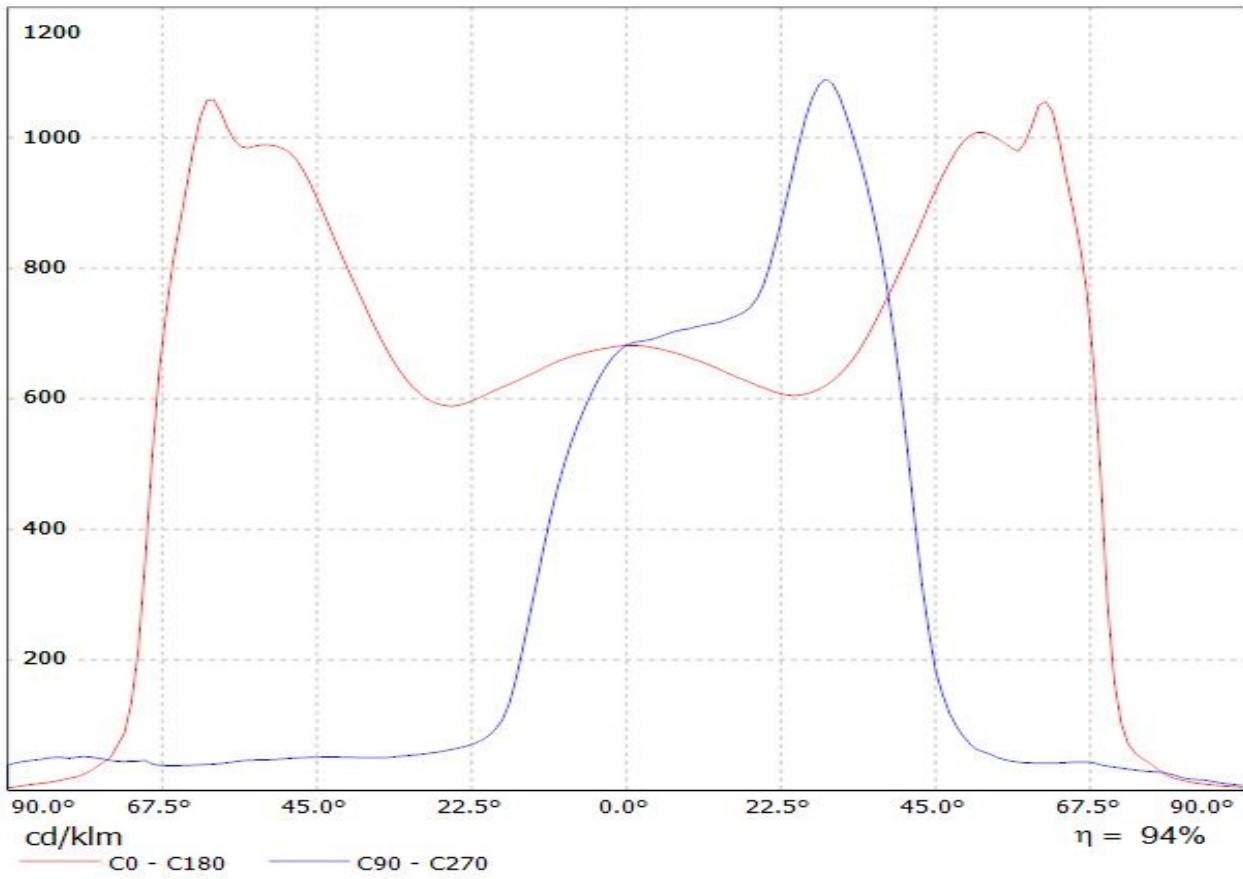

Luminaire: LEDiL Oy C12419_STRADA-2X2-A-T_(Tridonic_Module_RLE_G1)
Lamps: 1 x Tridonic_Module_RLE_G1_2288lm@700mA_P=16W_I=0.700A

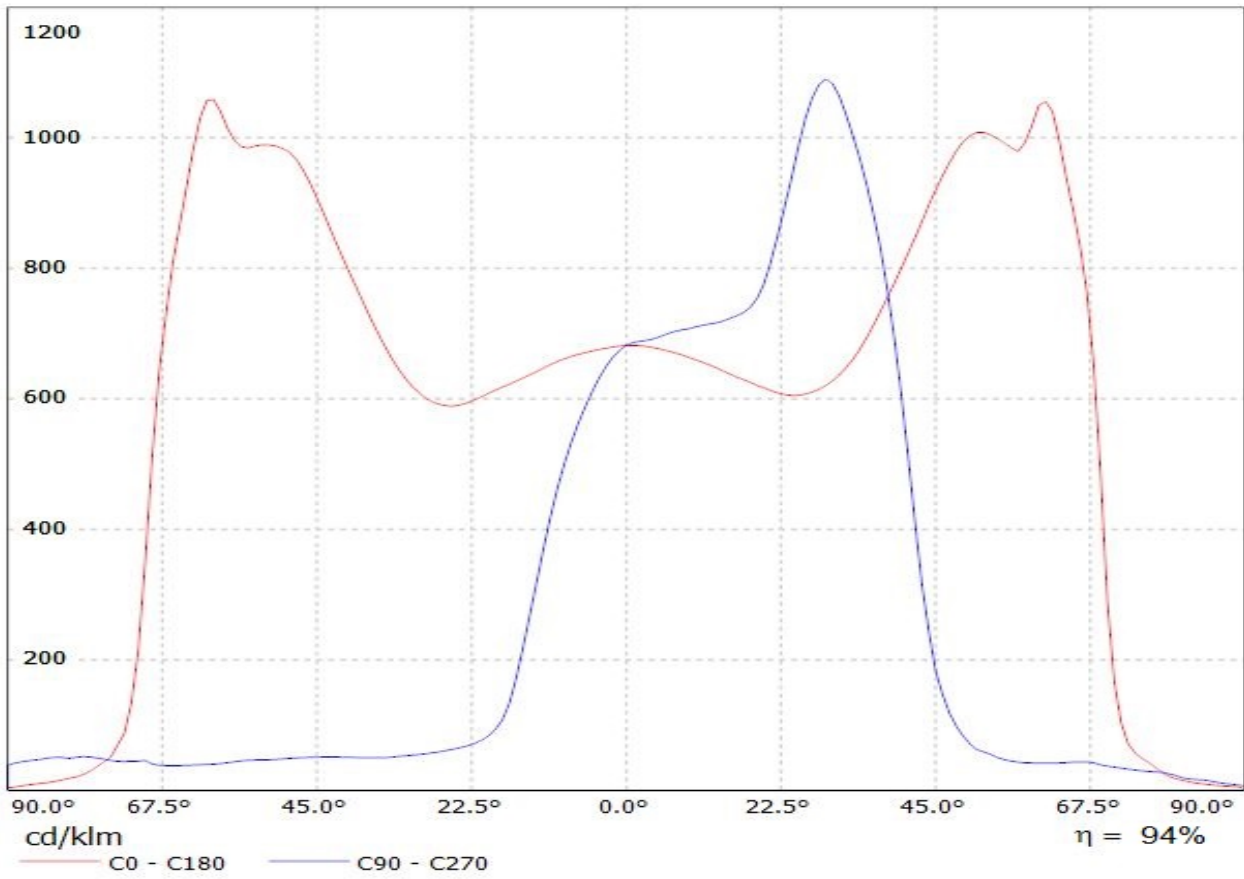

Luminaire: LEDil Oy C12419_STRADA-2X2-A-T_(XM-L2) Efficiency=94%
Lamps: 1 x Cree XM-L2 (XMLBWT-0-7B4-T30-0L-0001) 356lm @ 250mA CCT=3200K P=2.8W I=250mA

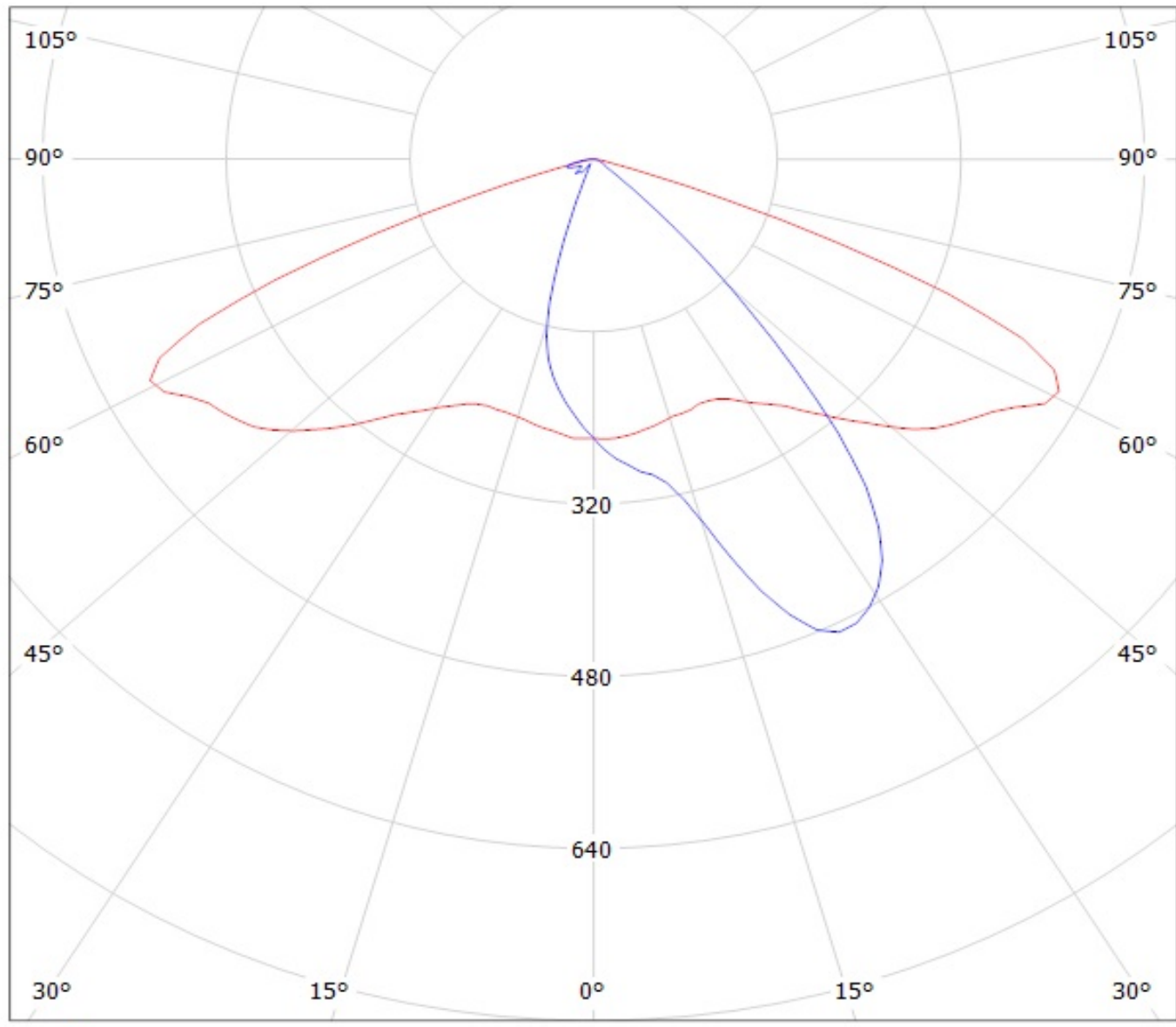

cd/klm
— C0 - C180 — C90 - C270

Luminaire: LEDil Oy C12419_STRADA-2X2-A-T_(XP-G2) Efficiency=94%

Lamps: 1 x Cree XP-G2 (XPGBWT-L1-000-00G51) 350lm @ 250mA CCT=7200K P=2.9W I=250mA

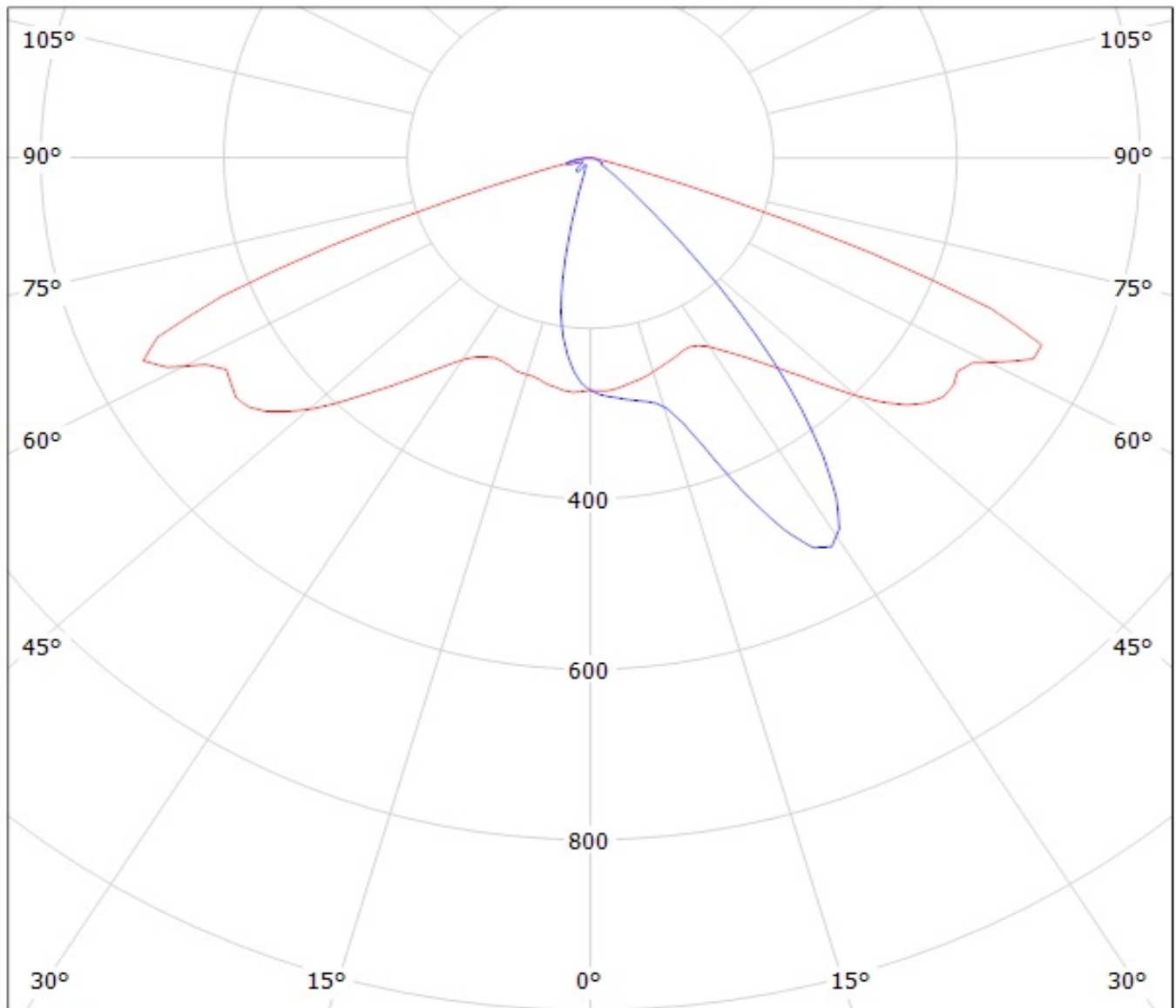

cd/klm

— C0 - C180

— C90 - C270

Luminaire: LEDiL Oy C12419_STRADA-2x2-A-T_(XP-L)

Lamps: 1 x CREE_XP-L_2x2_(XPLAWT-0-1B0-V40-00-0001)_517lm@250mA_CCT=7600K_P=2.79963W_I=249.9mA

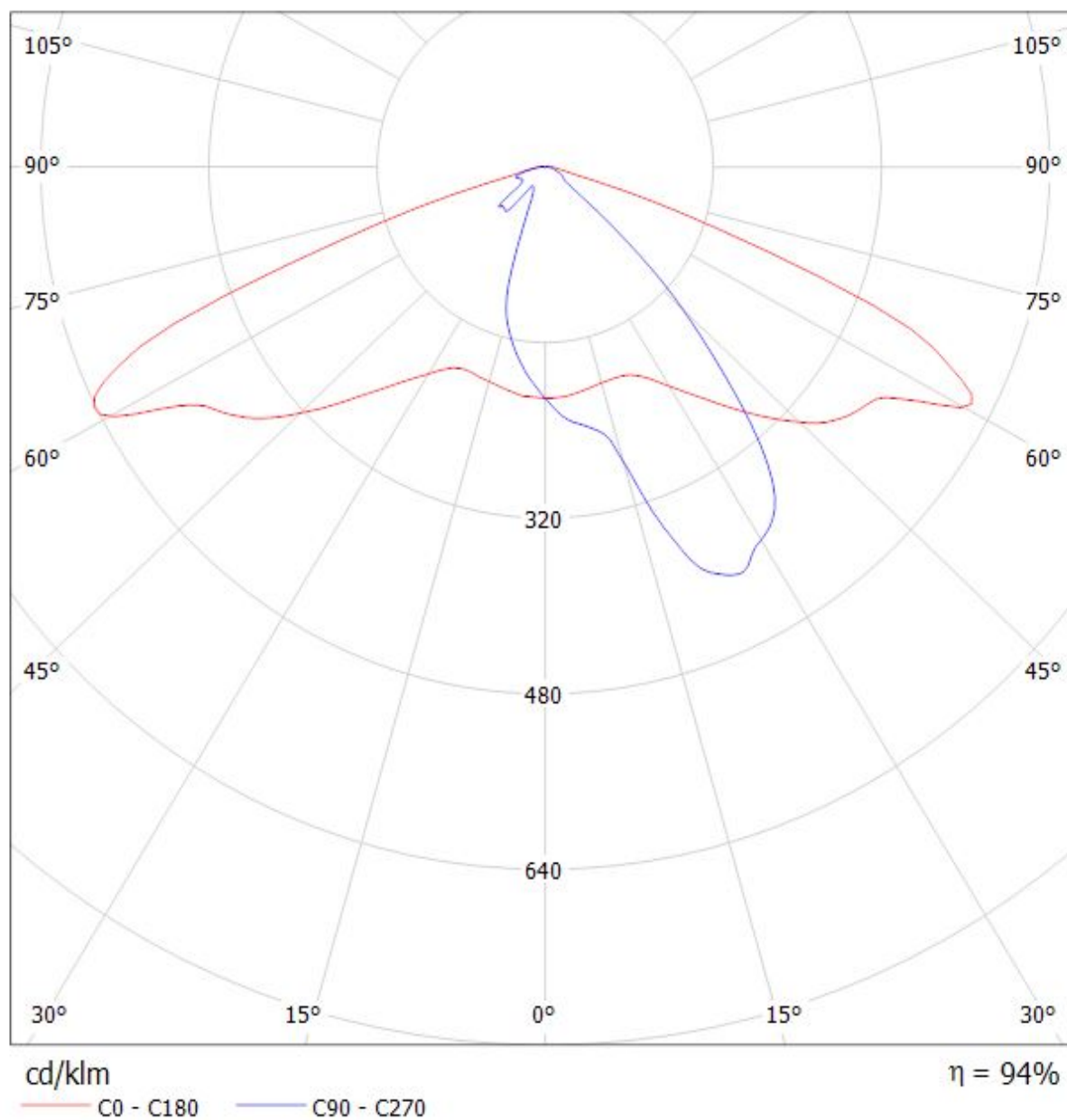

Luminaire: LEDiL Oy C12419_STRADA-2X2-A-T_(XP-L_HI)
Lamps: 1 x Cree_XP-L_HI_(2x2)_(XPLAWT-H-5A3-U60-013-0001)
_455.077lm@250mA_P=2.84011W_I=0,2499A

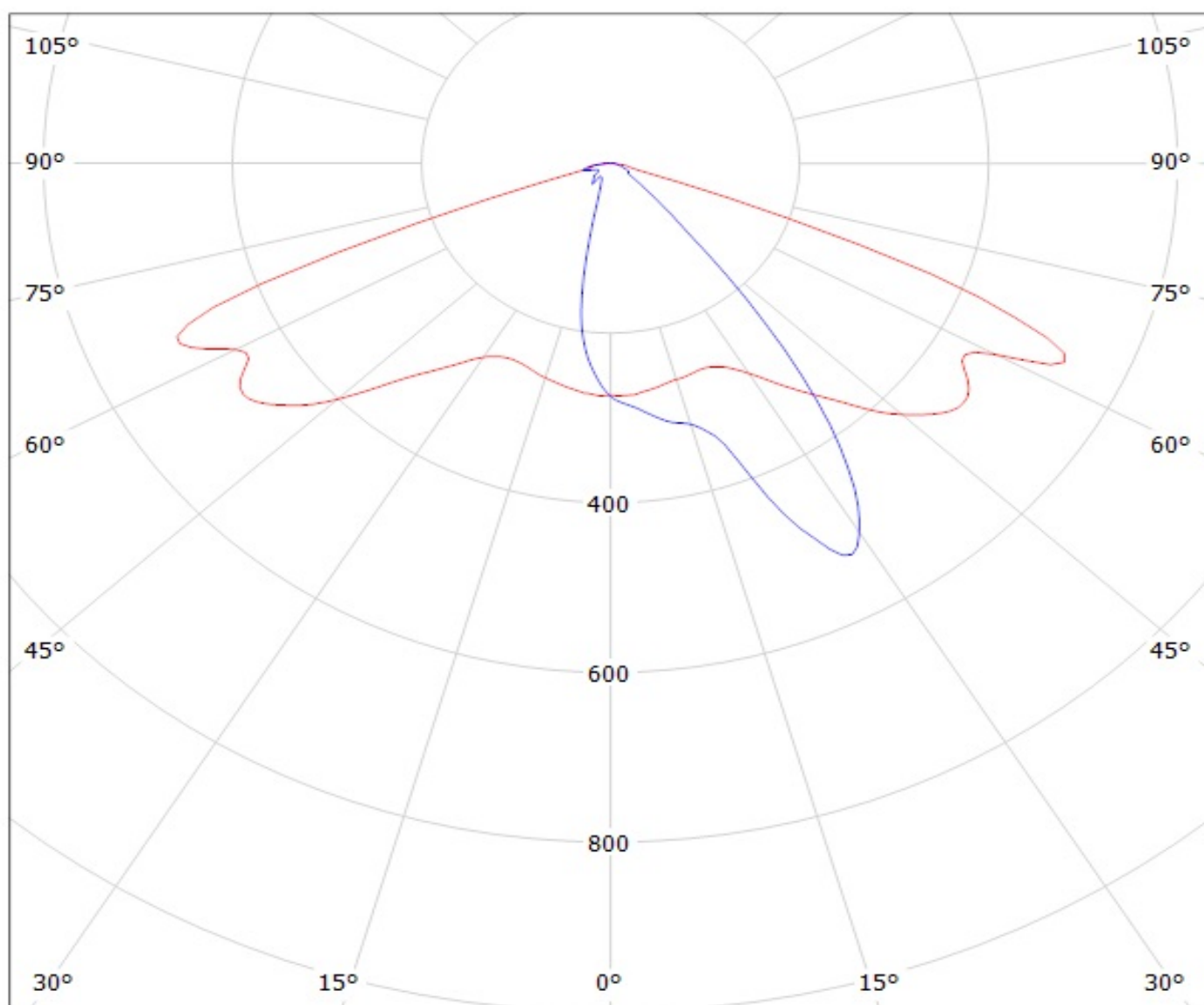

cd/klm

$\eta = 96\%$

— C0 - C180 — C90 - C270

Luminaire: Ledil C12419_STRADA-2X2-A-T_(XP-L2)

Lamps: 1 x Cree_XP-L2_2x2_(XPLBWT-00-0000-000BV50E3)550.93lm@250mA_P=2.7815W_I=0.25A

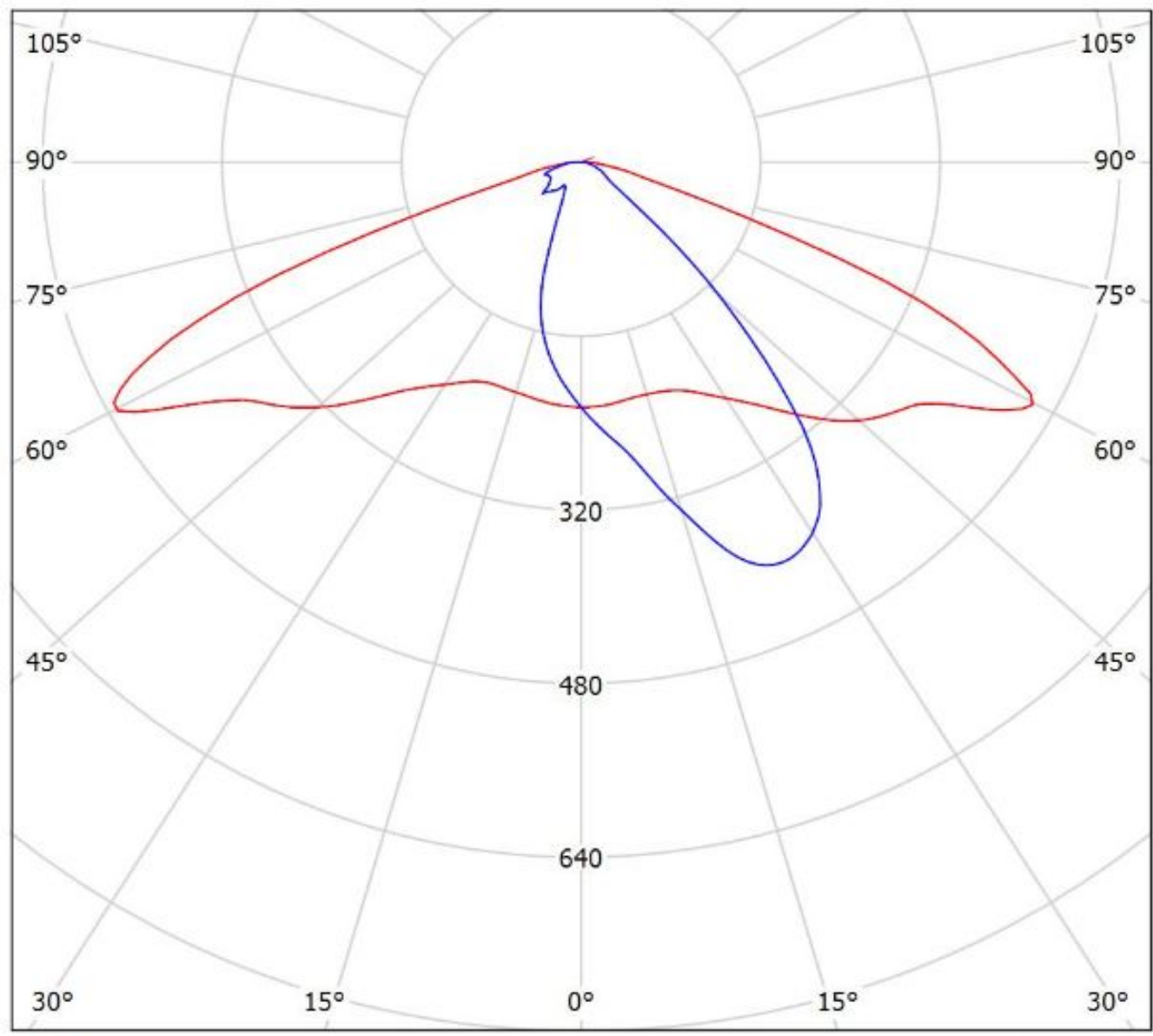

cd/klm

— C0 - C180 — C90 - C270

$\eta = 98\%$

Luminaire: LEDiL Oy C12419_STRADA-2X2-A-T_(LG3535) Eff. 96,1%
Lamps: 1 x LG Ceramic 3535 PKG (372lm@250mA)

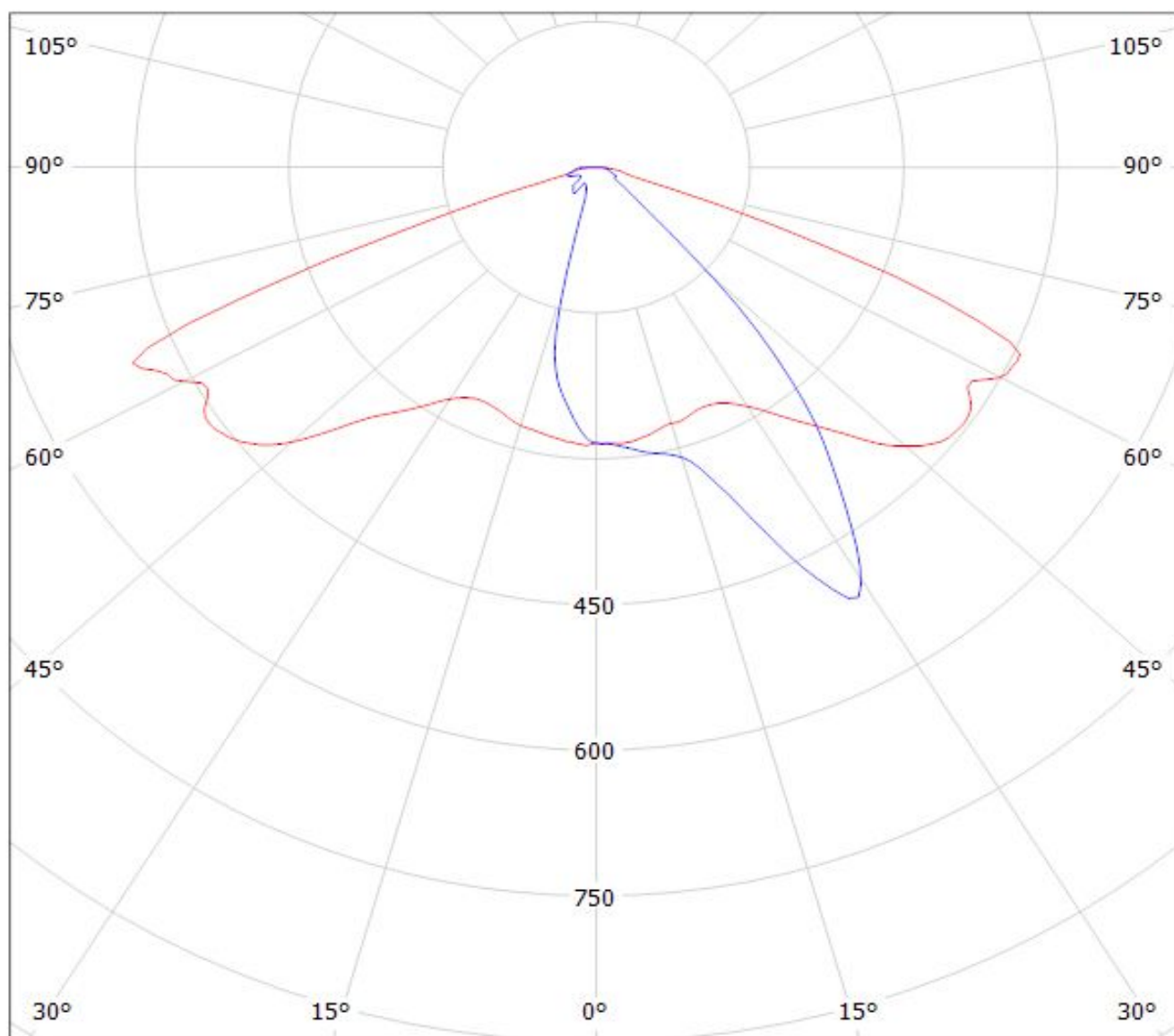

cd/klm

— C0 - C180

— C90 - C270

$\eta = 96\%$

Luminaire: Ledil C12419_STRADA-2X2-A-T_(H35C1)
Lamps: 1 x LG_H35C1_2x2_477.216lm@250mA_P=2.87475W_I=0.250A

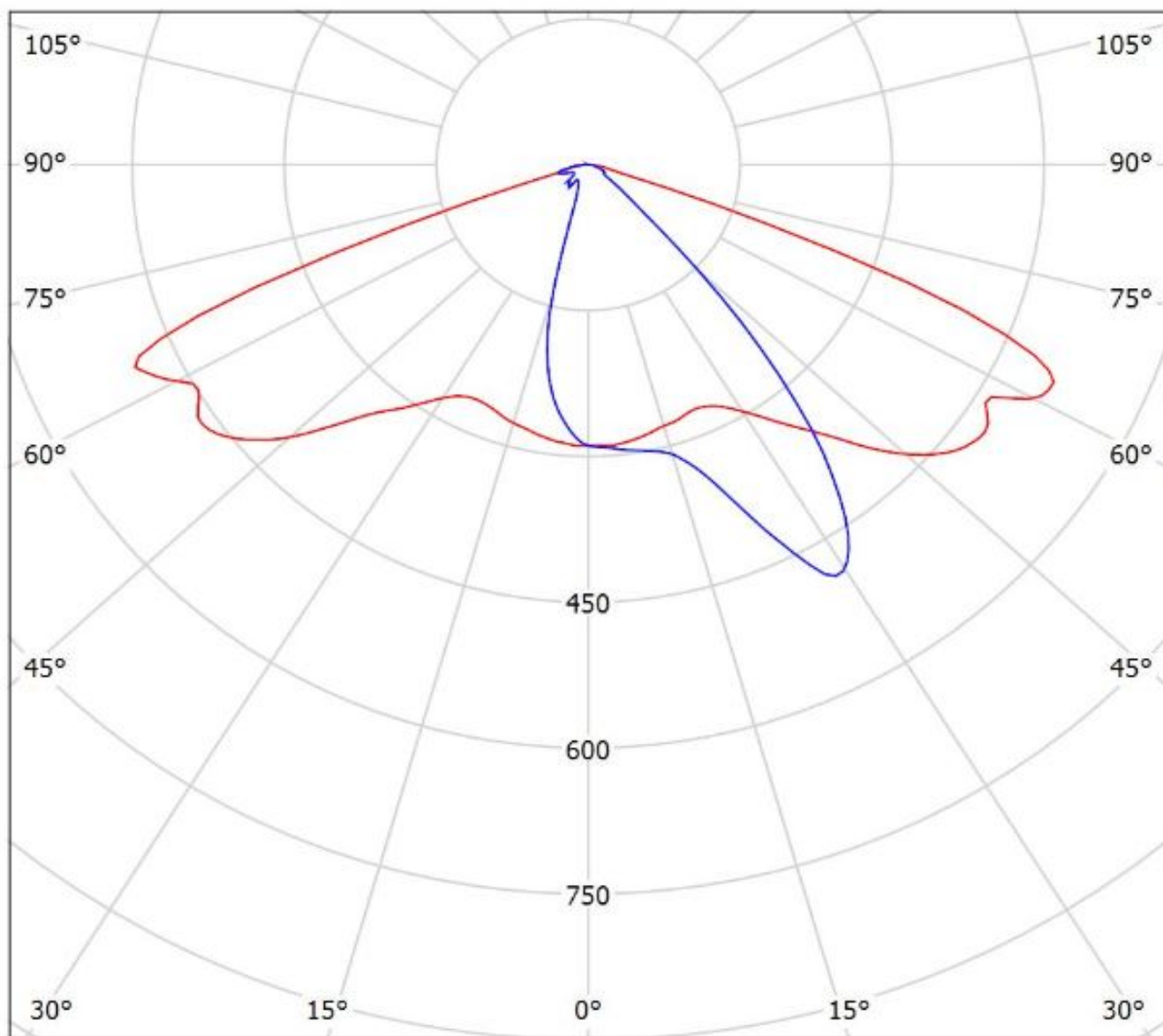

cd/klm
— C0 - C180 — C90 - C270

$\eta = 96\%$

Luminaire: Ledil Oy C12419-Strada_2x2_A-T (RE-ES) Efficiency=93%
Lamps: 1 x Luxeon-Rebel-ES 250mA 500lm

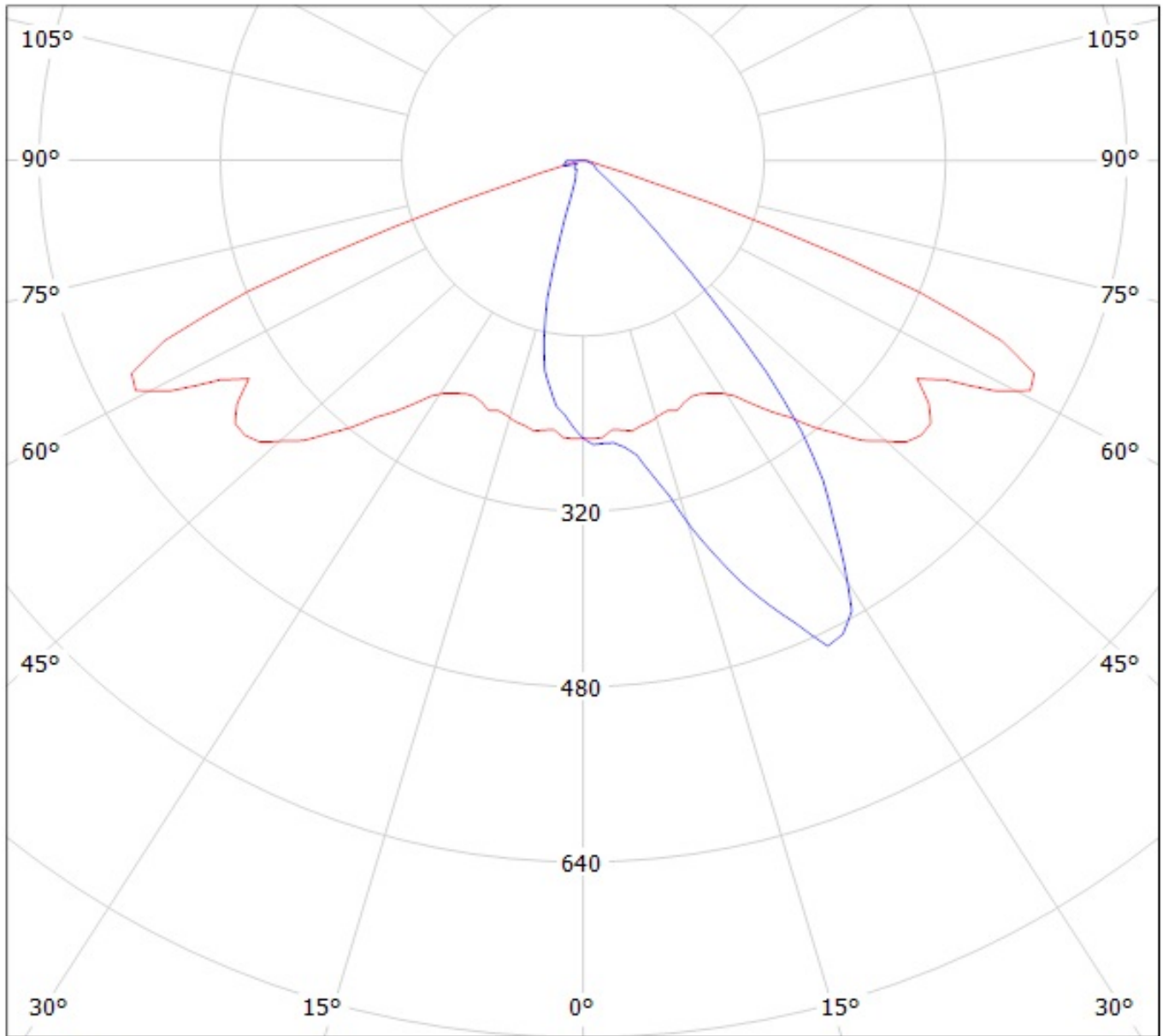

cd/klm

— C0 - C180

— C90 - C270

LEDiL Oy C12419_STRADA-2X2-A-T_(LUXEON_T) Eff.94.0% / LDC (Polar)

Luminaire: LEDiL Oy C12419_STRADA-2X2-A-T_(LUXEON_T) Eff.94.0%

Lamps: 1 x LUXEON_T_2x2_(LXH8-FW30-3)_296.55lm@250mA_P=2.79863W_I=249.9mA

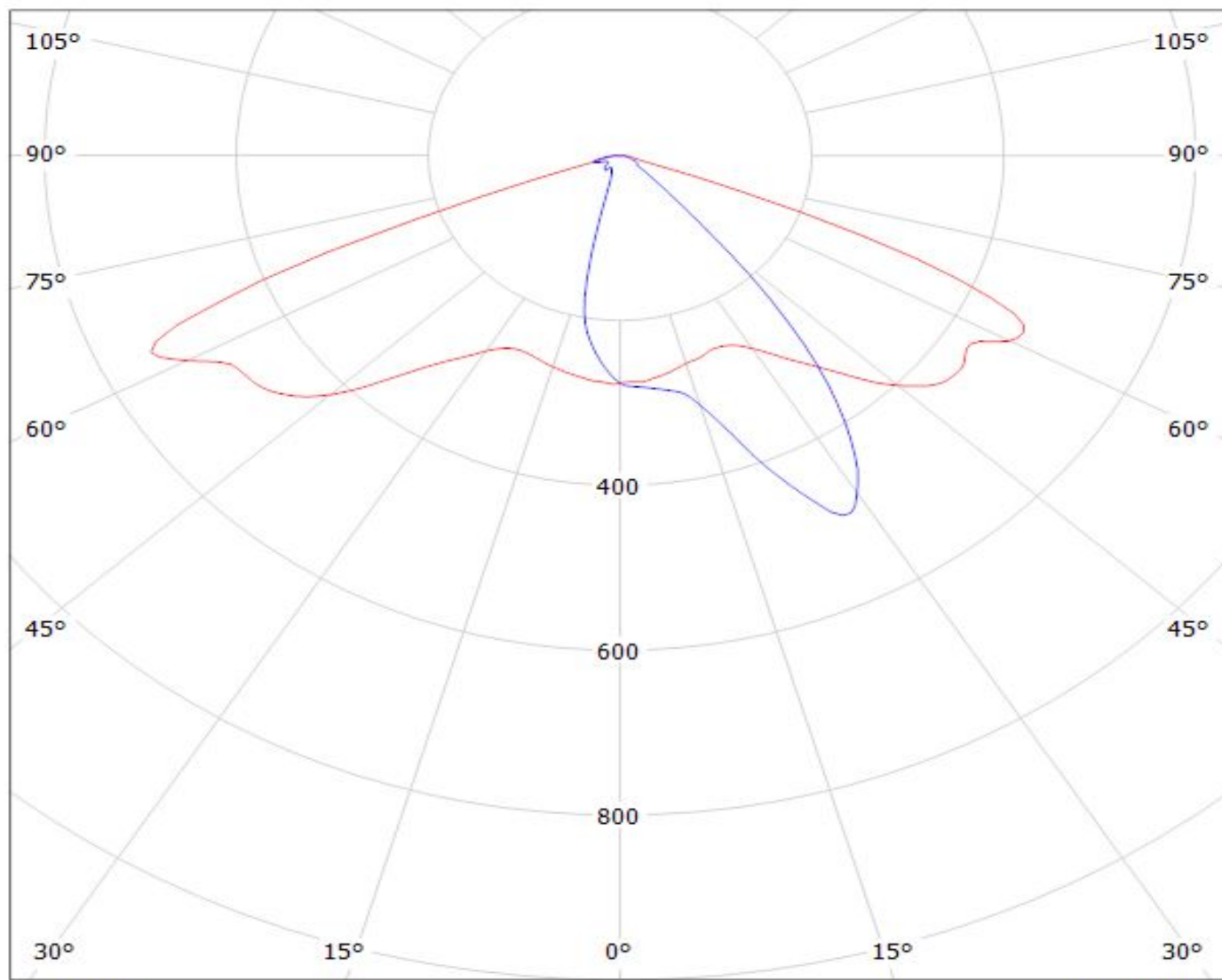

cd/klm

— C0 - C180

— C90 - C270

$\eta = 94\%$

Luminaire: LEDiL Oy C12419_STRADA-2X2-A-T_(LUXEON_Q)

Lamps: 1 x LUXEON_Q_2x2_(LHQ-3080)_298.615lm@250mA_P=2.86995W_I=249.8mA

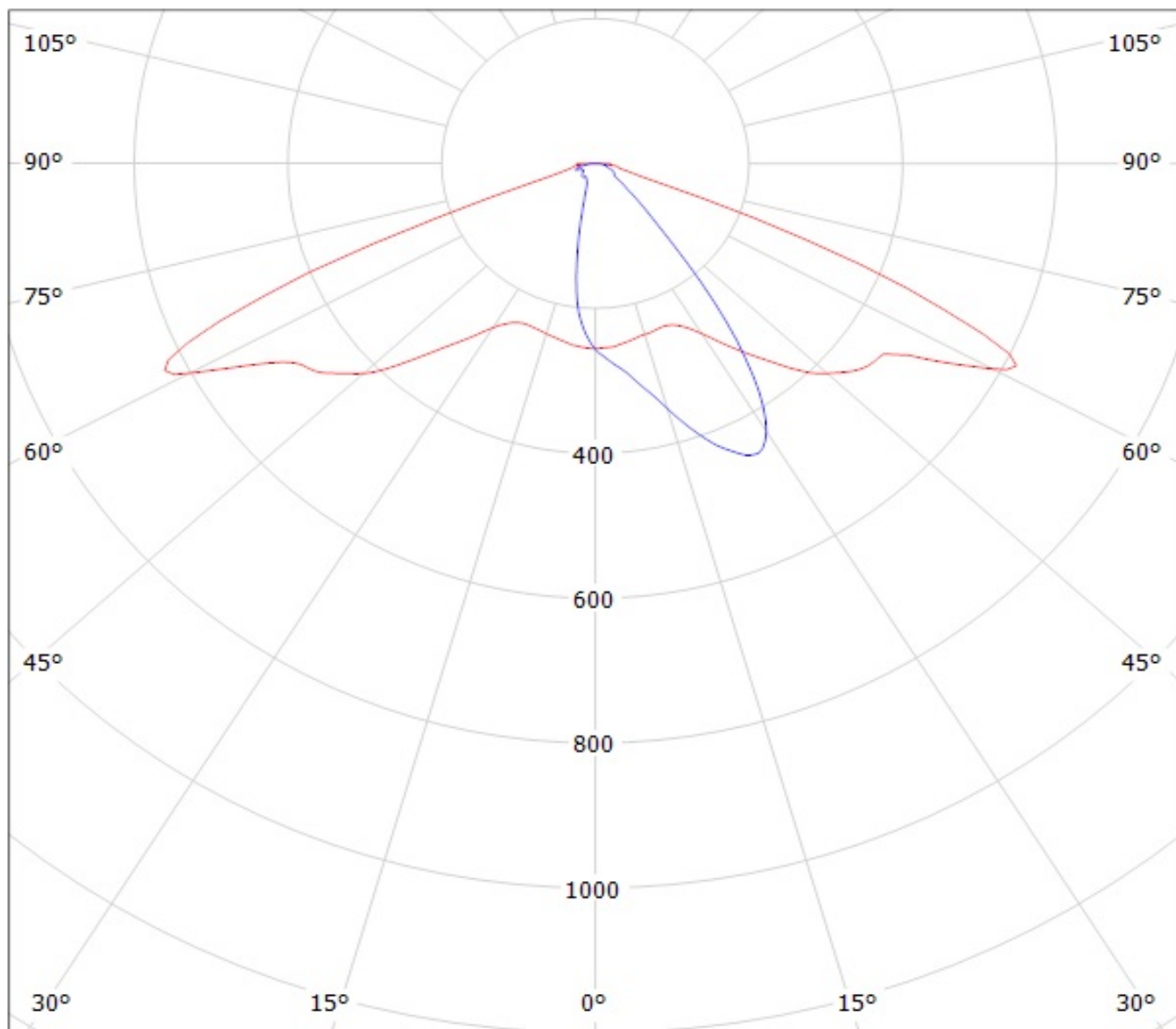

cd/klm

— C0 - C180

— C90 - C270

Luminaire: LEDiL Oy C12419_STRADA-2X2-A-T_(LUXEON_MZ) Eff.94.0%

Lamps: 1 x LUXEON_MZ_2x2_(LMZ7-QW57)_420.65lm@250mA_P=2.71916W_CCT=5700K_I=249.9mA

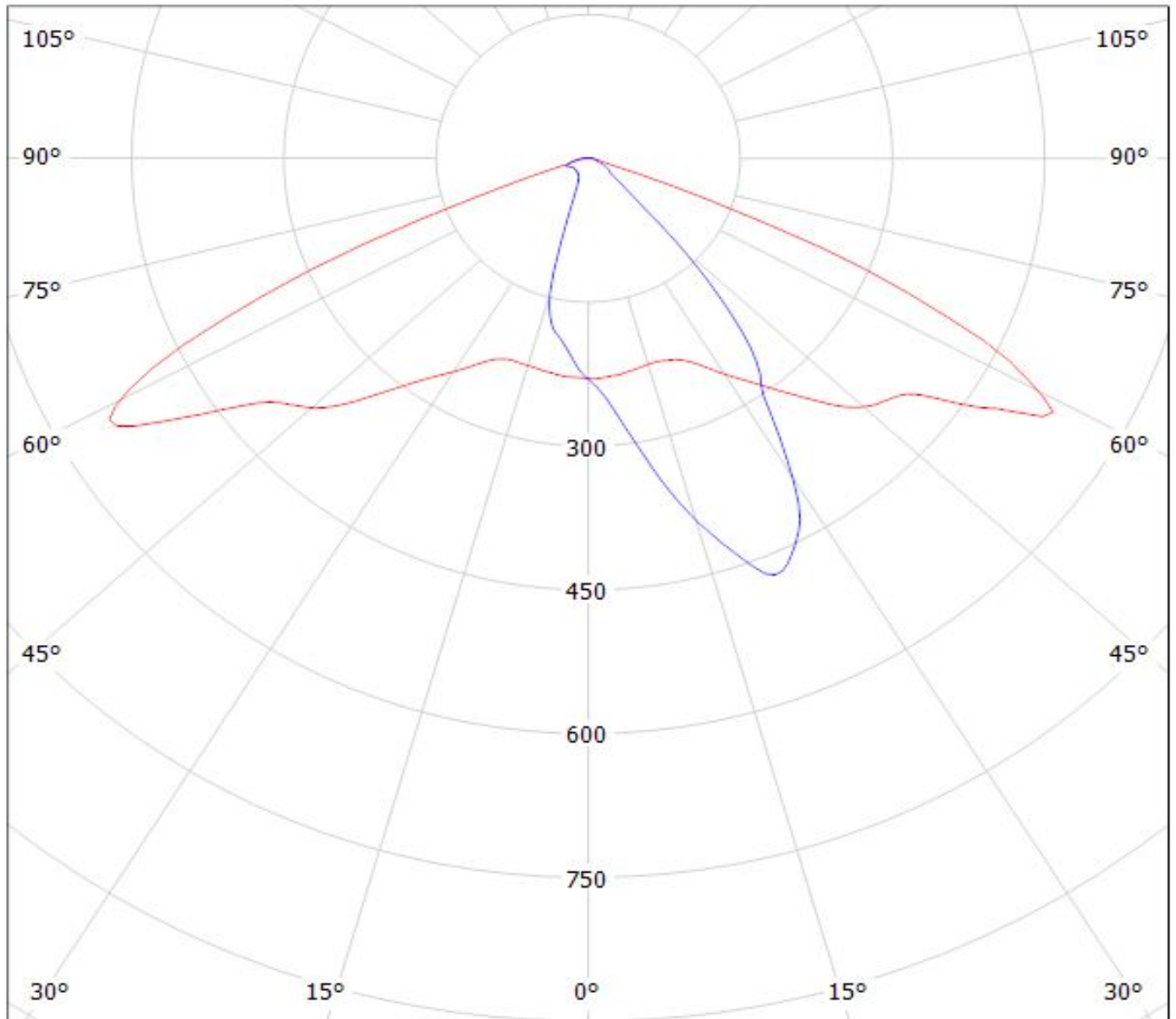

cd/klm

— C0 - C180

— C90 - C270

$\eta = 94\%$

Luminaire: LEDiL Oy C12419_STRADA-2X2-A-T_(Luxeon_TX)
Lamps: 1 x Luxeon_TX_(L1T2-3585)_319.001lm@250mA_P=2.78902W_I=0.250A

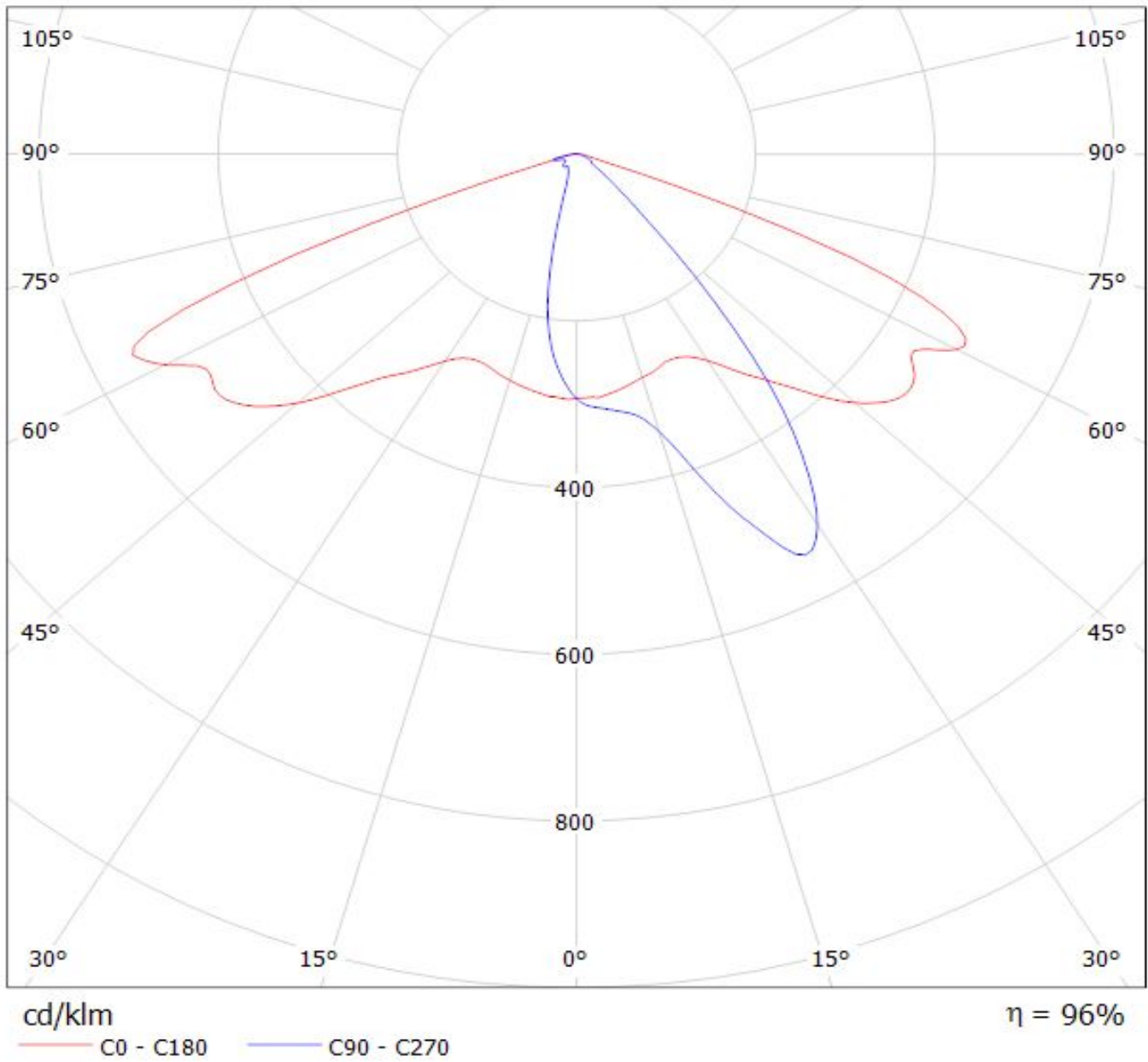

**LEDiL Oy C12419_STRADA-2x2-AT_(NICHIA_NS9x383) Eff.97.1% / LDC
(Polar)**

Luminaire: LEDiL Oy C12419_STRADA-2x2-AT_(NICHIA_NS9x383) Eff.97.1%
Lamps: 1 x NICHIA_NS9x383 (287.074lm@250mA)

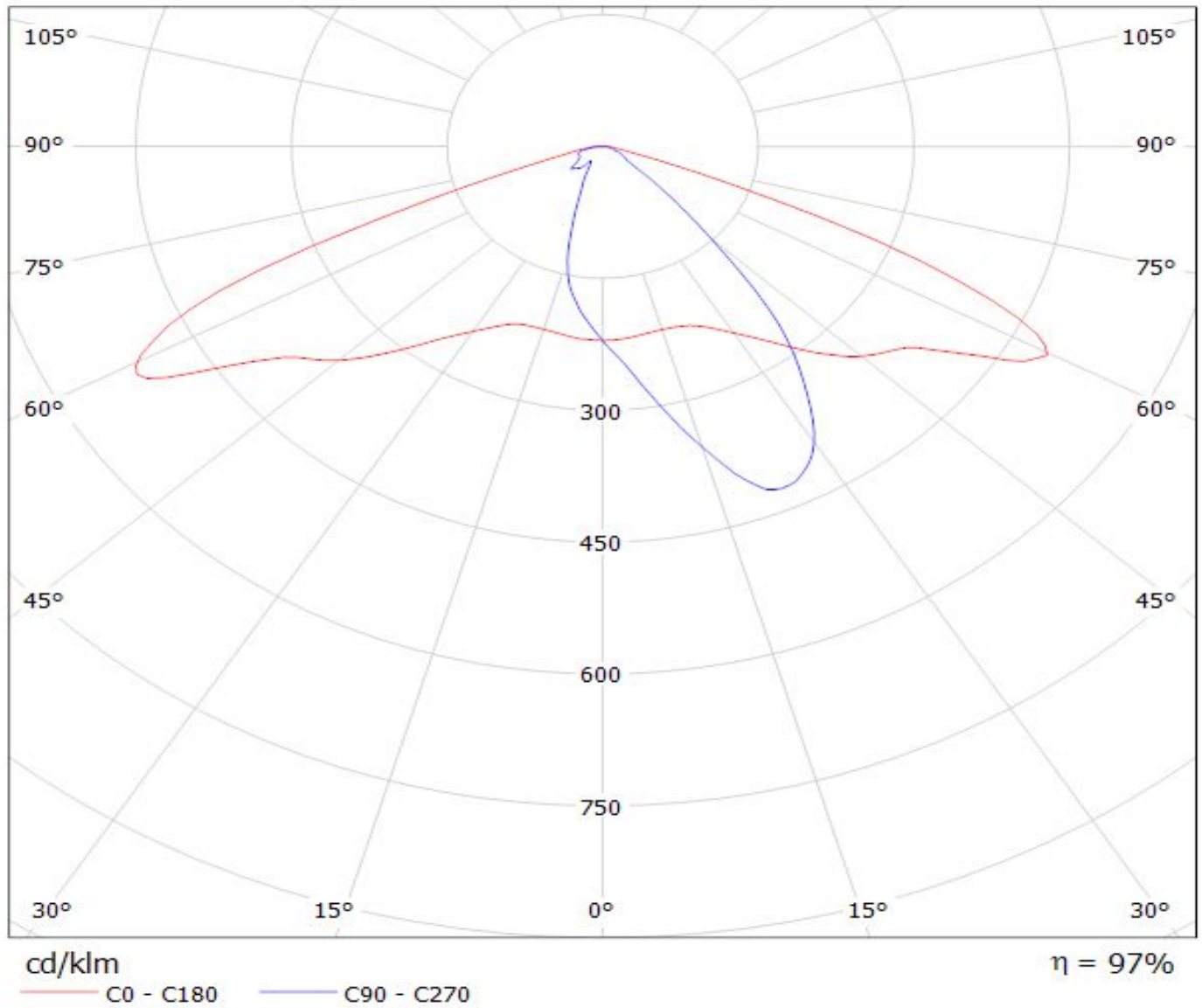

Luminaire: Ledil C12419_STRADA-2X2-A-T_(NVSW319AE)
Lamps: 1 x Nichia_NVSW319AE_(sm405D440f2L2R70)

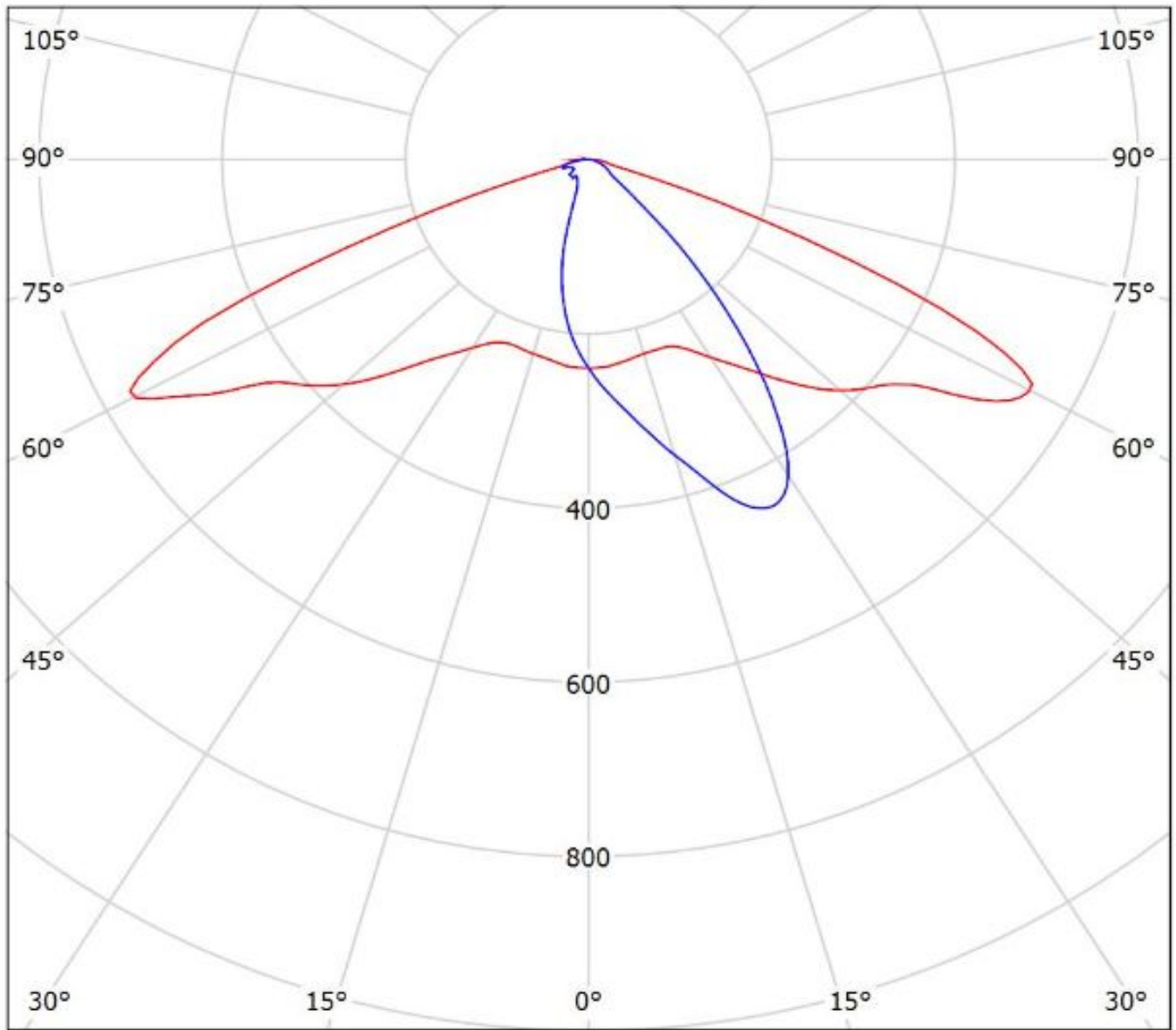

cd/klm
— C0 - C180 — C90 - C270

$\eta = 97\%$

Luminaire: LEDiL Oy C12419_STRADA-2X2-A-T_(E21A)
Lamps: 1 x Nichia_E21A_452.248lm@250mA_2.805W_I=0.250A

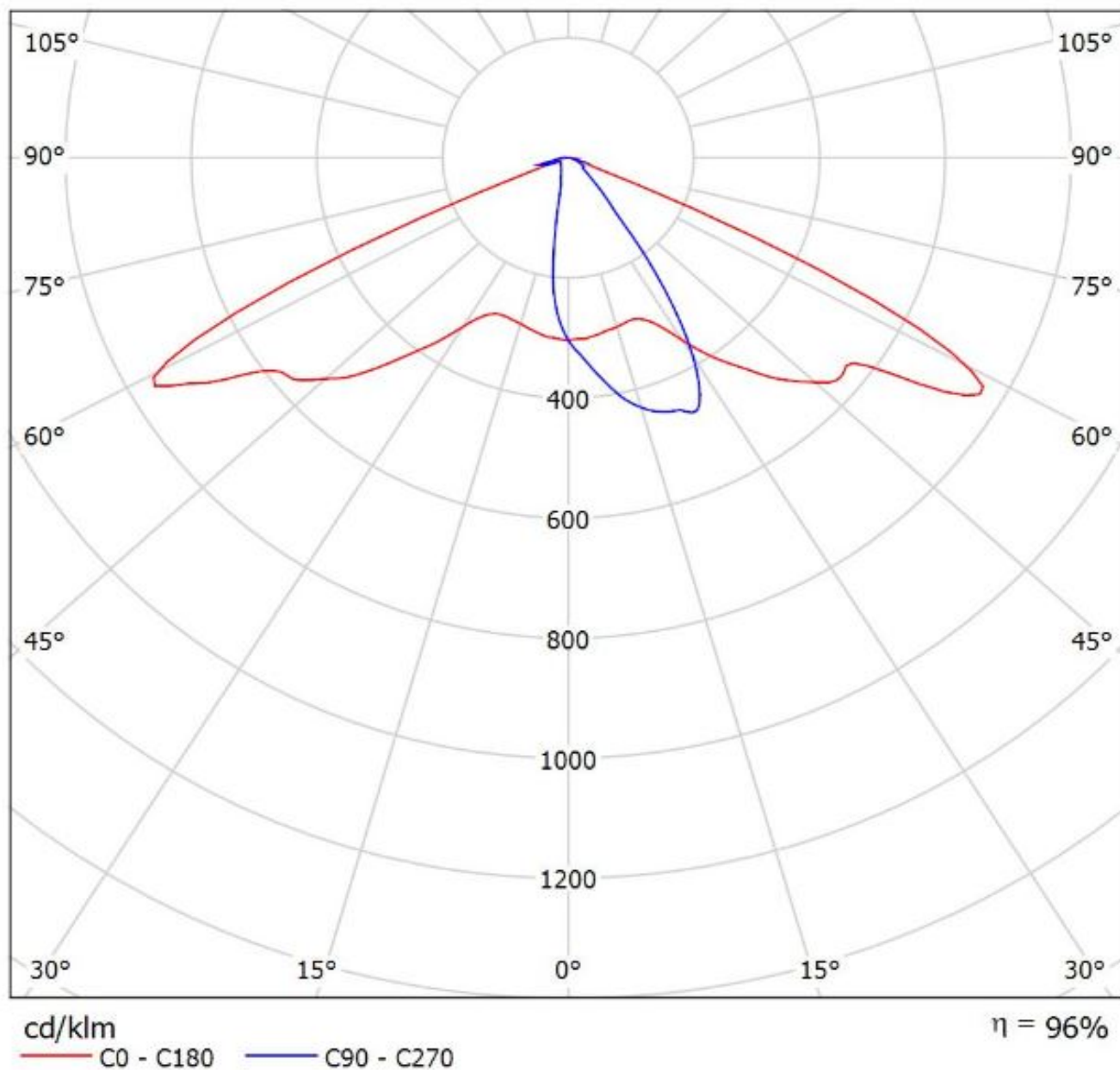

Luminaire: Ledil Oy C12419_STRADA-2X2-A-T (Osram Square PC 398lm @ 250mA) Efficiency=93%
Lamps: 1 x Osram Square PC 398lm @ 250mA

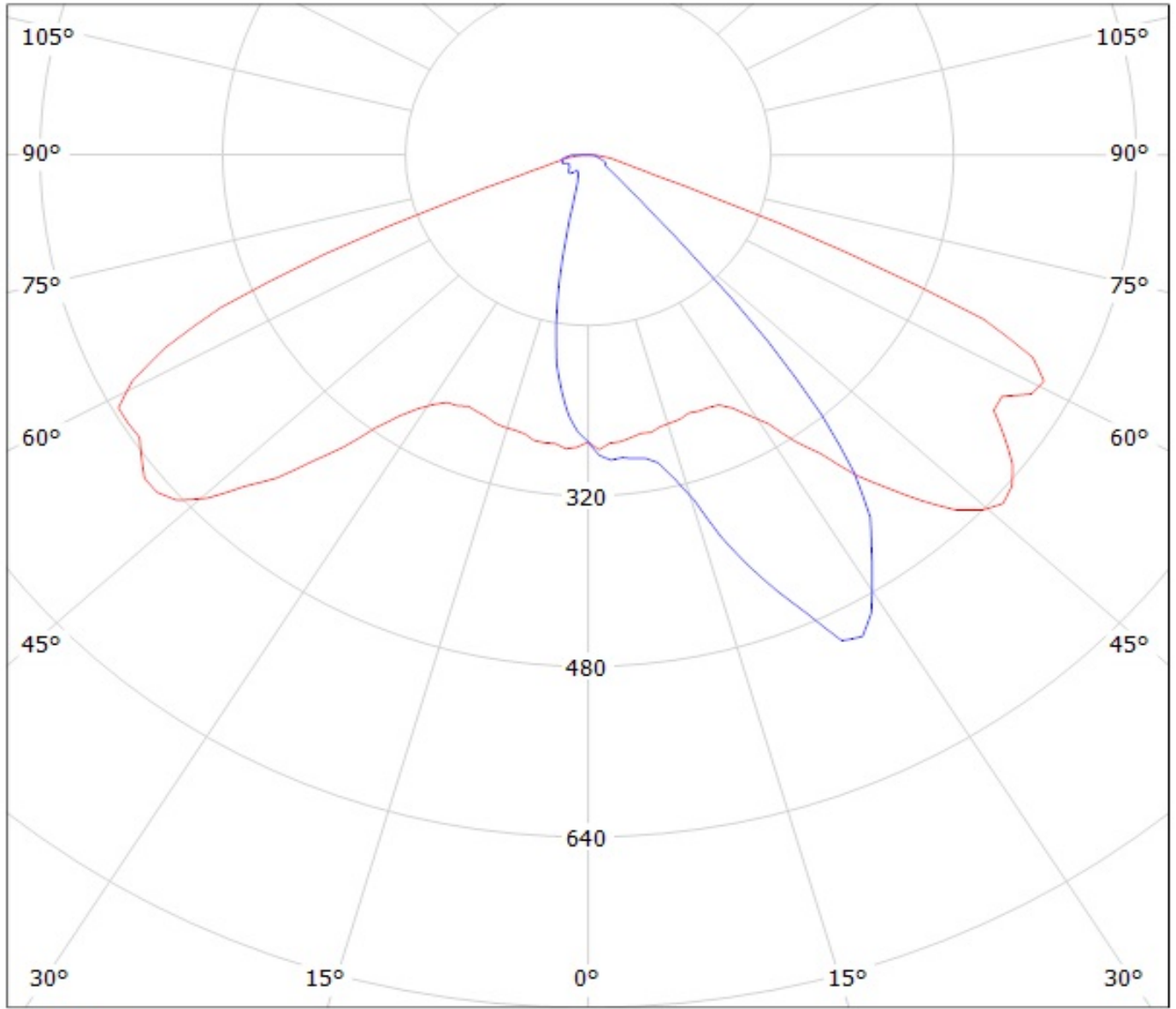

cd/klm
— C0 - C180 — C90 - C270

Luminaire: Ledil C12419_STRADA-2X2-A-T_(square_gen3)

Lamps: 1 x Osram_square_gen3_2x2_(GW_CSSRM2.PM)_460.271lm@250mA_CCT=5000K_P=2.80625W_I=0.25A

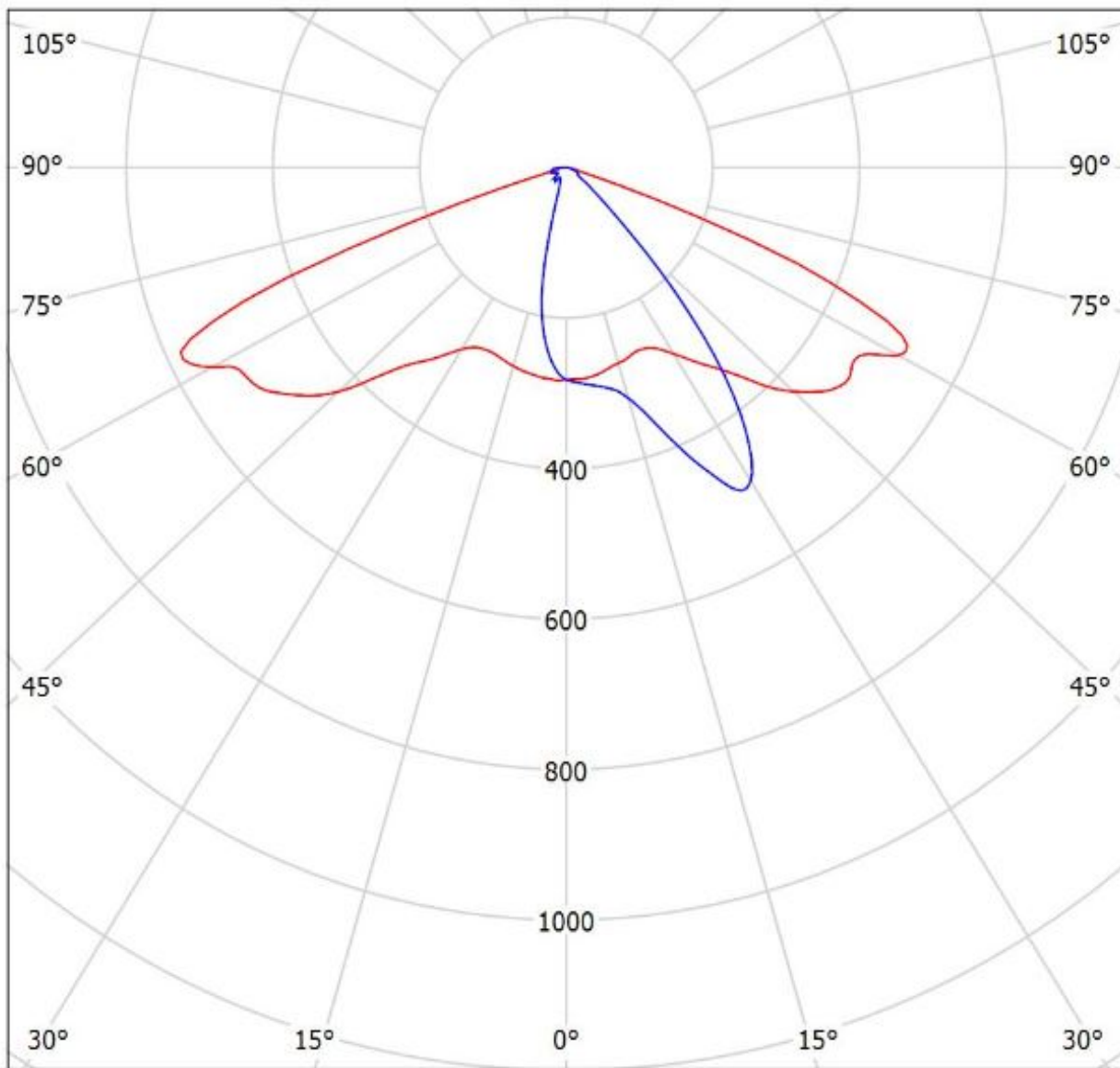

cd/klm

— C0 - C180 — C90 - C270

$\eta = 96\%$

Luminaire: Ledil Oy -C12419STRADA-2X2-A-T_(DURIS_S8)_SIMULATED
Lamps: 1 x OSRAM_DURIS S8 GEN2 5050 package

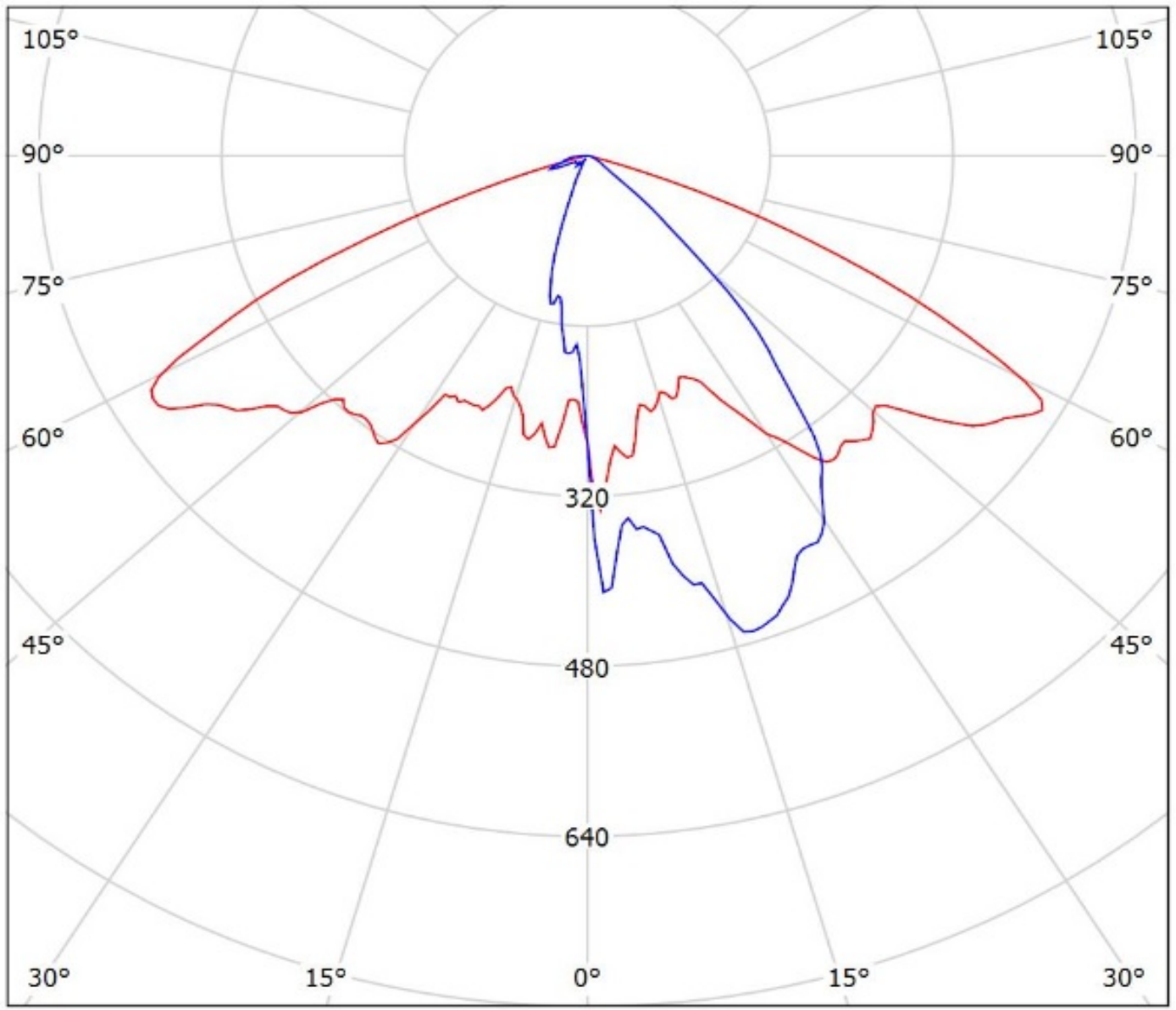

cd/klm

— C0 - C180 — C90 - C270

η = 93%

Luminaire: LEDiL Oy C12419_STRADA-2X2-A-T_(Fortimo_F-Flex_2x8_740DAG3)

Lamps: 1 x Philips_Fortimo_F-Flex_2x8_740DAG3_1786.86lm@250mA_P=11.6092W_I=0.2498A

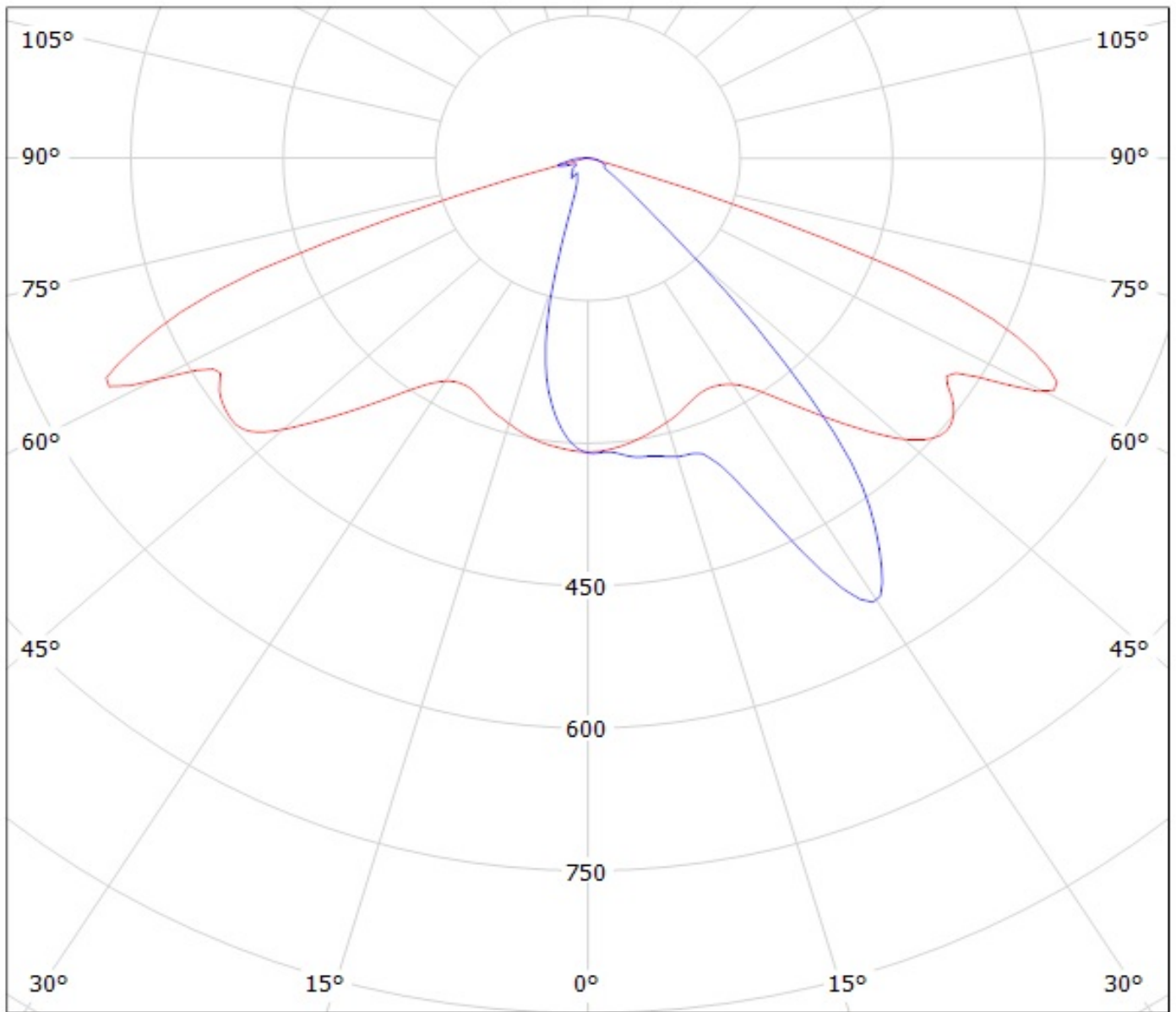

cd/klm

$\eta = 97\%$

— C0 - C180

— C90 - C270

Luminaire: LEDiL Oy C12419_STRADA-2X2-A-T_(LH351B)

Lamps: 1 x SAMSUNG_LH351B_2x2_443.65lm@250mA_P=2.84311W_I=249.9mA

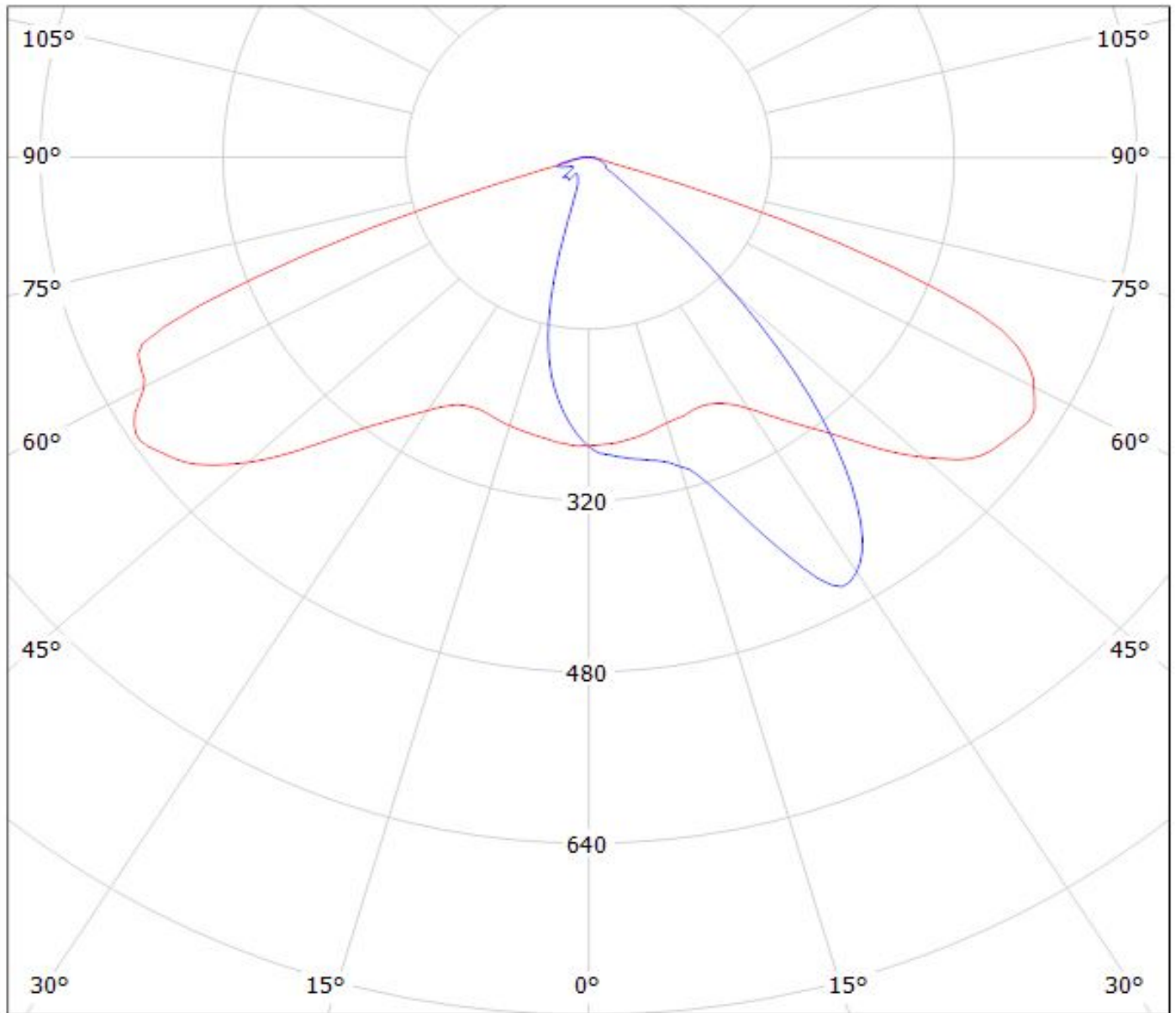

cd/klm

— C0 - C180 — C90 - C270

$\eta = 94\%$

Luminaire: LEDiL Oy C12419_STRADA-2X2-A-T_(LH351Z)

Lamps: 1 x SAMSUNG_LH351Z_2x2_367.95lm@250mA_P=2.86371W_I=249.8mA

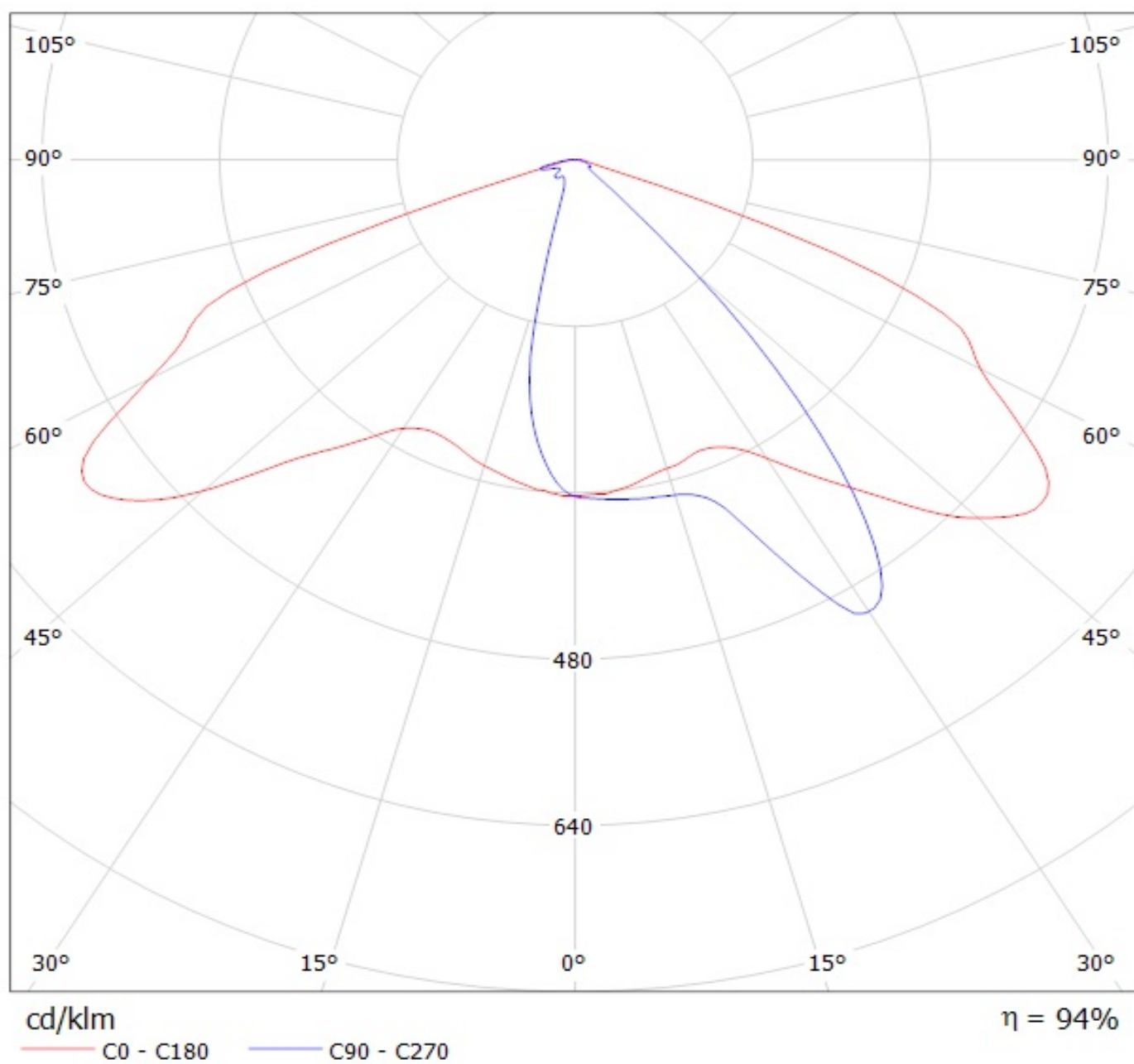

Luminaire: LEDiL Oy C12419_STRADA-2X2-A-T_(LH351D)

Lamps: 1 x Samsung_LH351D_524.264lm@250mA_P=2.7523W_I=0.250A

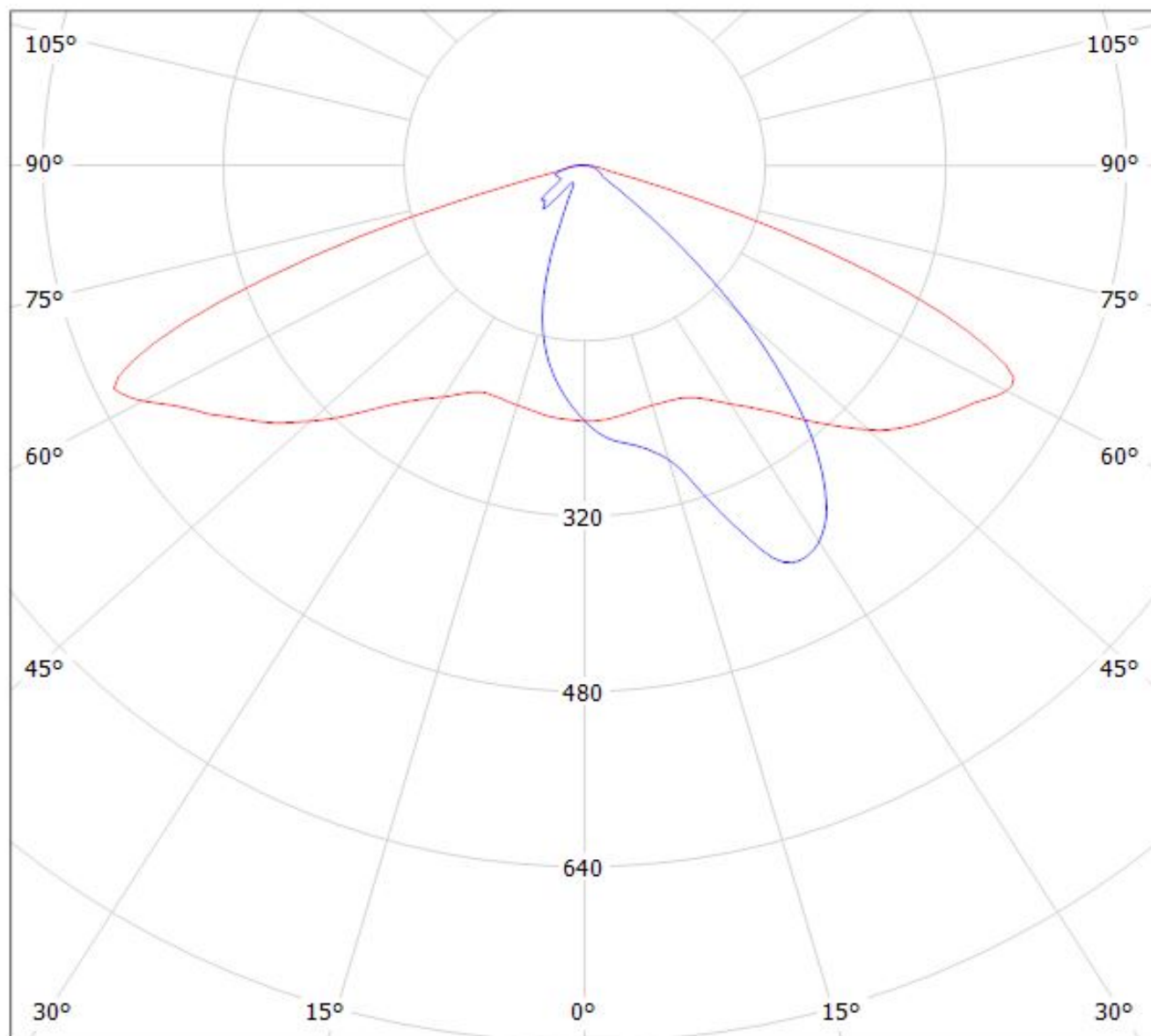

cd/klm

$\eta = 96\%$

— C0 - C180 — C90 - C270

Luminaire: LEDiL Oy C12419_STRADA-2x2-A-T_(MJT4040) Eff. 94%

Lamps: 1 x SEOUL ACHRICH MJT4040 (SAW09H0A) 255lm@40mA P=2.37W I=40mA

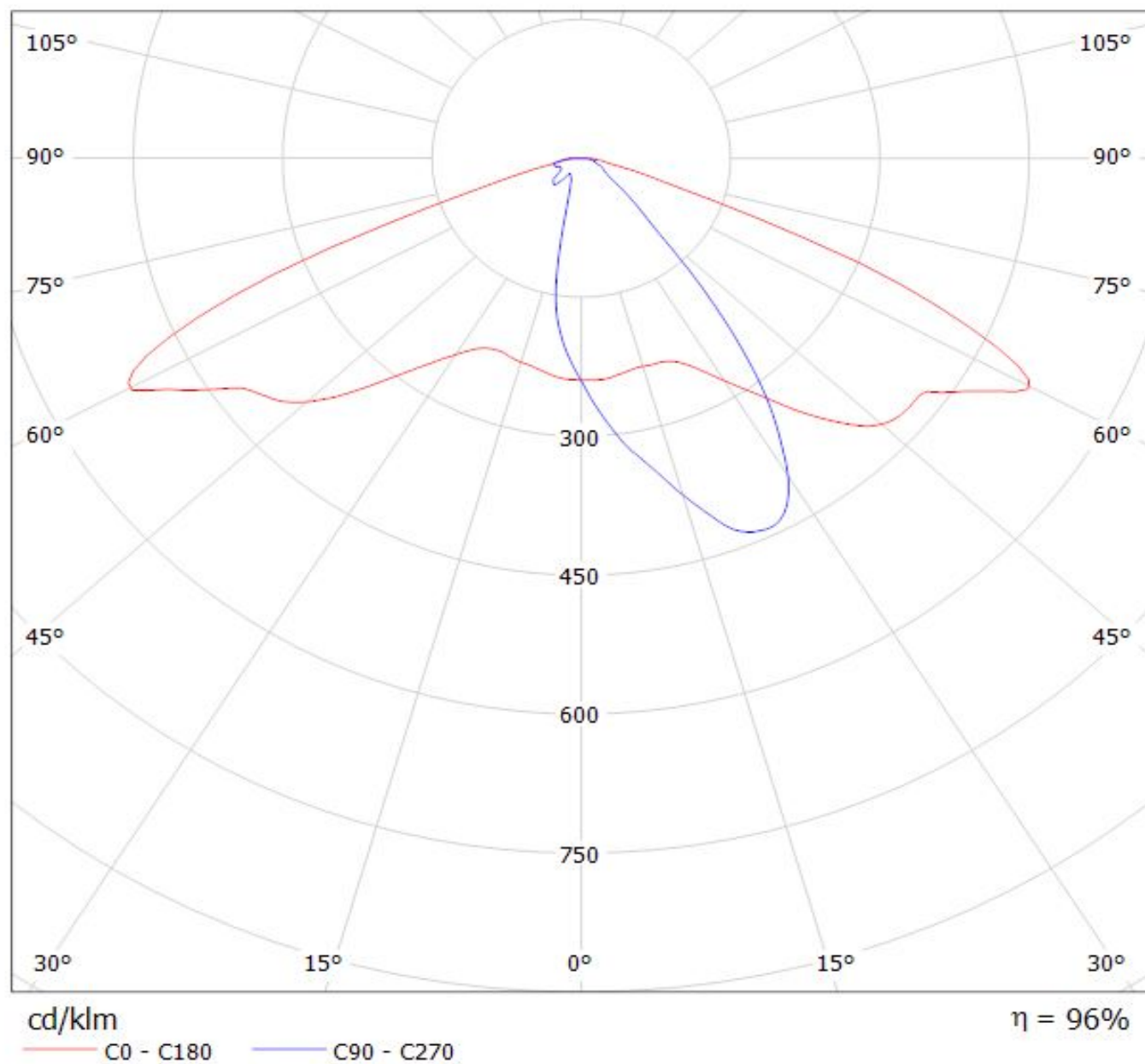

Luminaire: LEDil Oy C12419_STRADA-2X2-A-T_(Z5M1) Efficiency=94%
Lamps: 1 x Seoul Z5M1 (SZ5-M1-WN-C8) 379lm @ 250mA CCT=4600K P=2.9W I=250mA

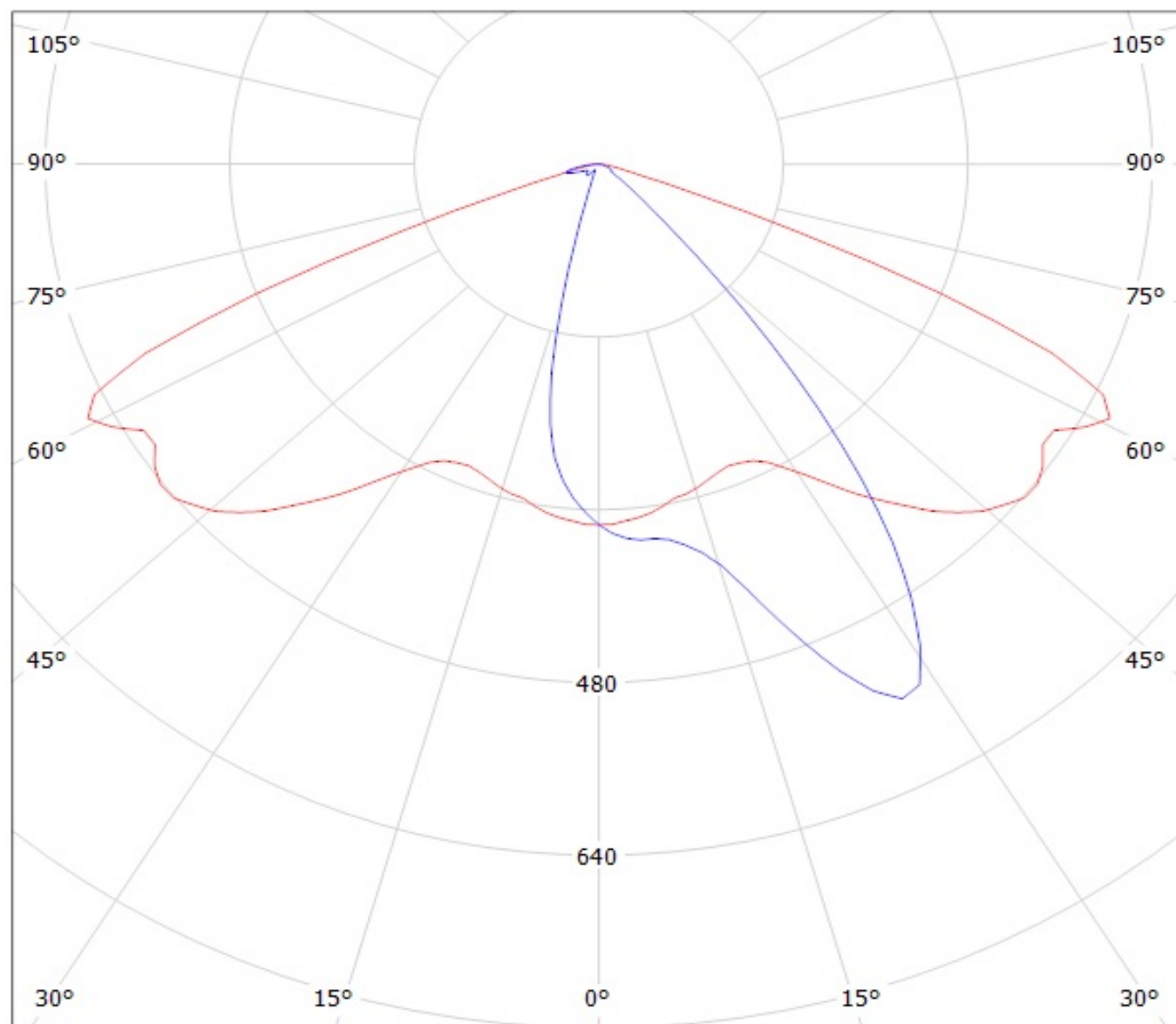

cd/klm

— C0 - C180

— C90 - C270

Luminaire: Ledil C12419_STRADA-2X2-A-T_(Z8Y22plus)

Lamps: 1 x Seoul_Z8Y22plus_(W6E2G)_513.996lm@250mA_P=2.754W_I=0.250A

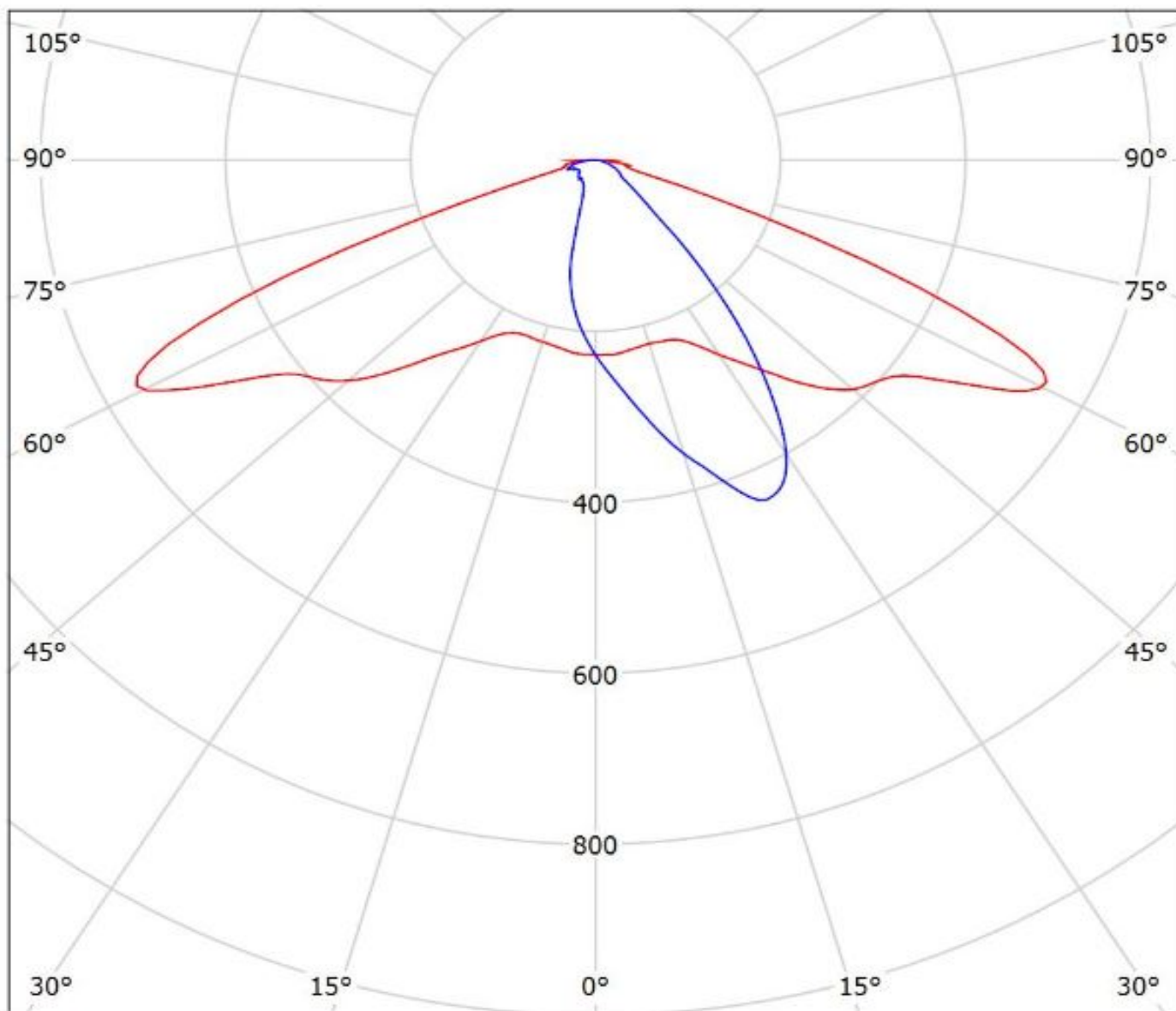

cd/klm

— C0 - C180 — C90 - C270

$\eta = 97\%$

Ledil C12419_STRADA-2X2-A-T_(TL1L3) / LDC (Polar)

Luminaire: Ledil C12419_STRADA-2X2-A-T_(TL1L3)

Lamps: 1 x Toshiba_TL1L3_2x2_(TL1L3-NW1.L)_387.773lm@250mA_CCT=5000K_P=2.829W_I=0.25A

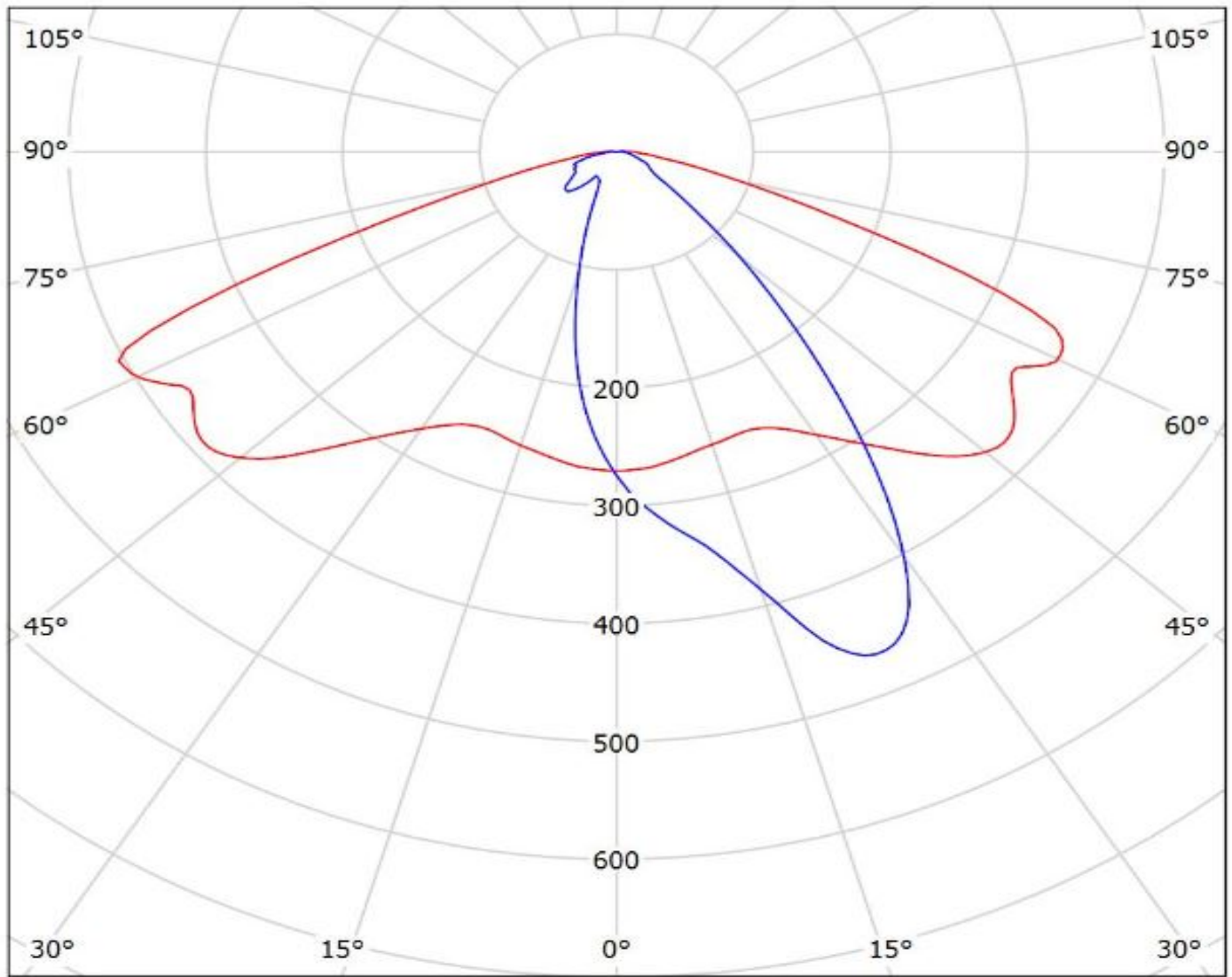

Ledil C12419_STRADA-2X2-A-T_(TL1L4) / LDC (Polar)

Luminaire: Ledil C12419_STRADA-2X2-A-T_(TL1L4)

Lamps: 1 x Toshiba_TL1L4_2x2_(TL1L4-DW0)_472.639lm@250mA_CCT=6500K_P=2.9W_I=0.25A

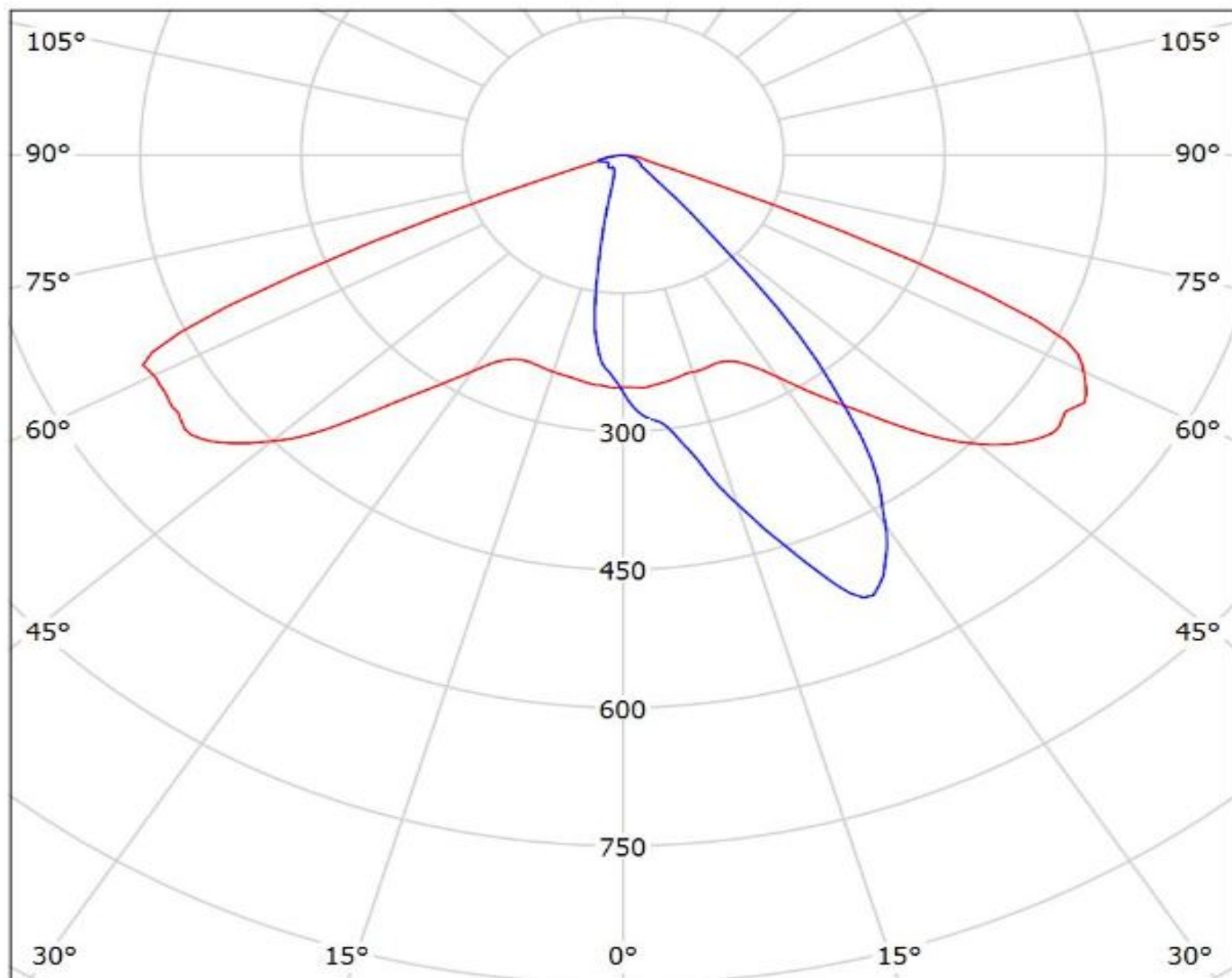

cd/klm

— C0 - C180 — C90 - C270

$\eta = 94\%$

Luminaire: LEDiL Oy C12419_STRADA-2X2-A-T_(Tridonic_Module_RLE_G1)
Lamps: 1 x Tridonic_Module_RLE_G1_4576.03lm@700mA_P=32.0681W_I=0.700A

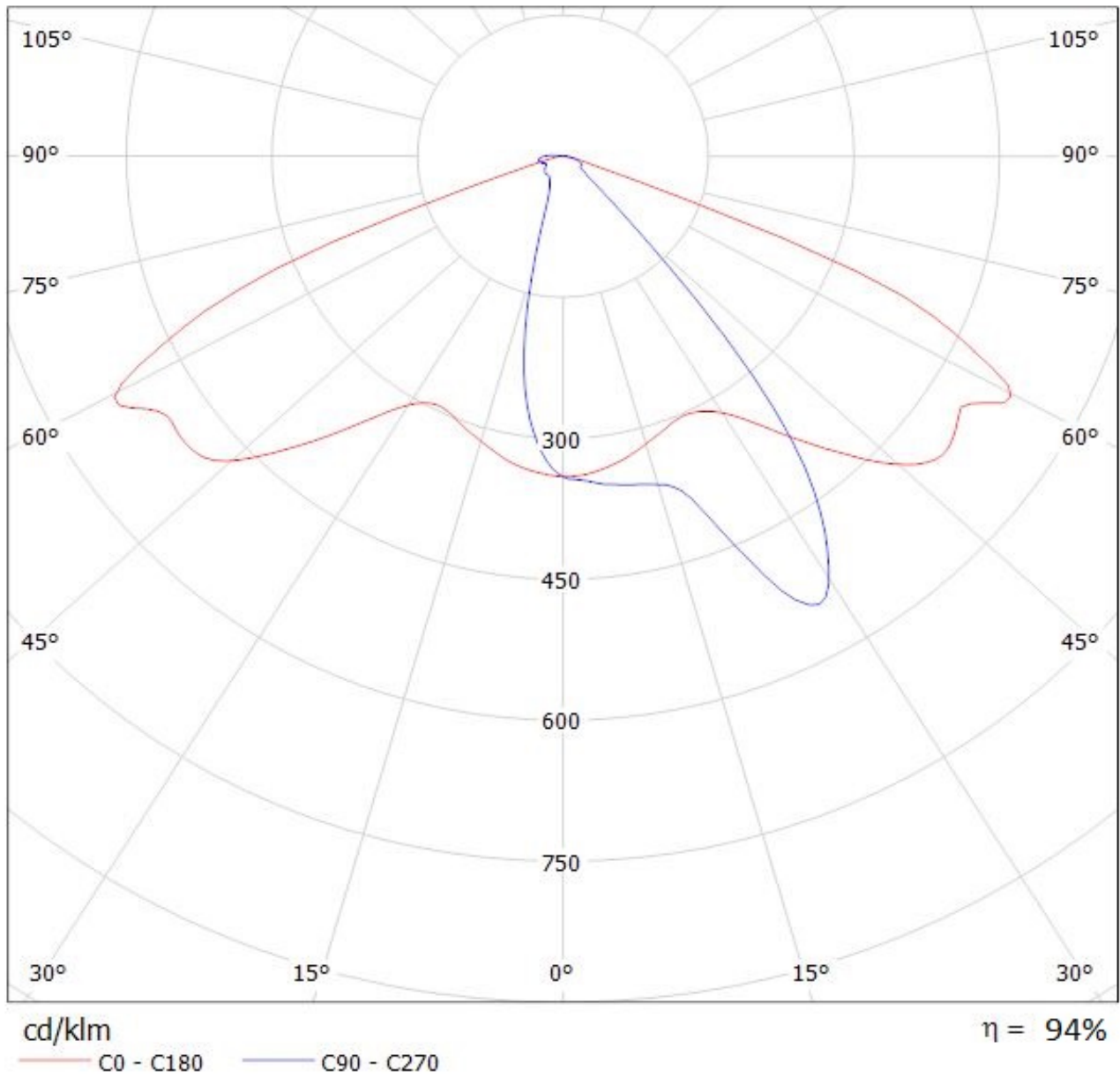

Luminaire: LEDiL Oy C12419_STRADA-2X2-A-T_(Tridonic_Module_RLE_G1)
Lamps: 1 x Tridonic_Module_RLE_G1_4576.03lm@700mA_P=32.0681W_I=0.700A

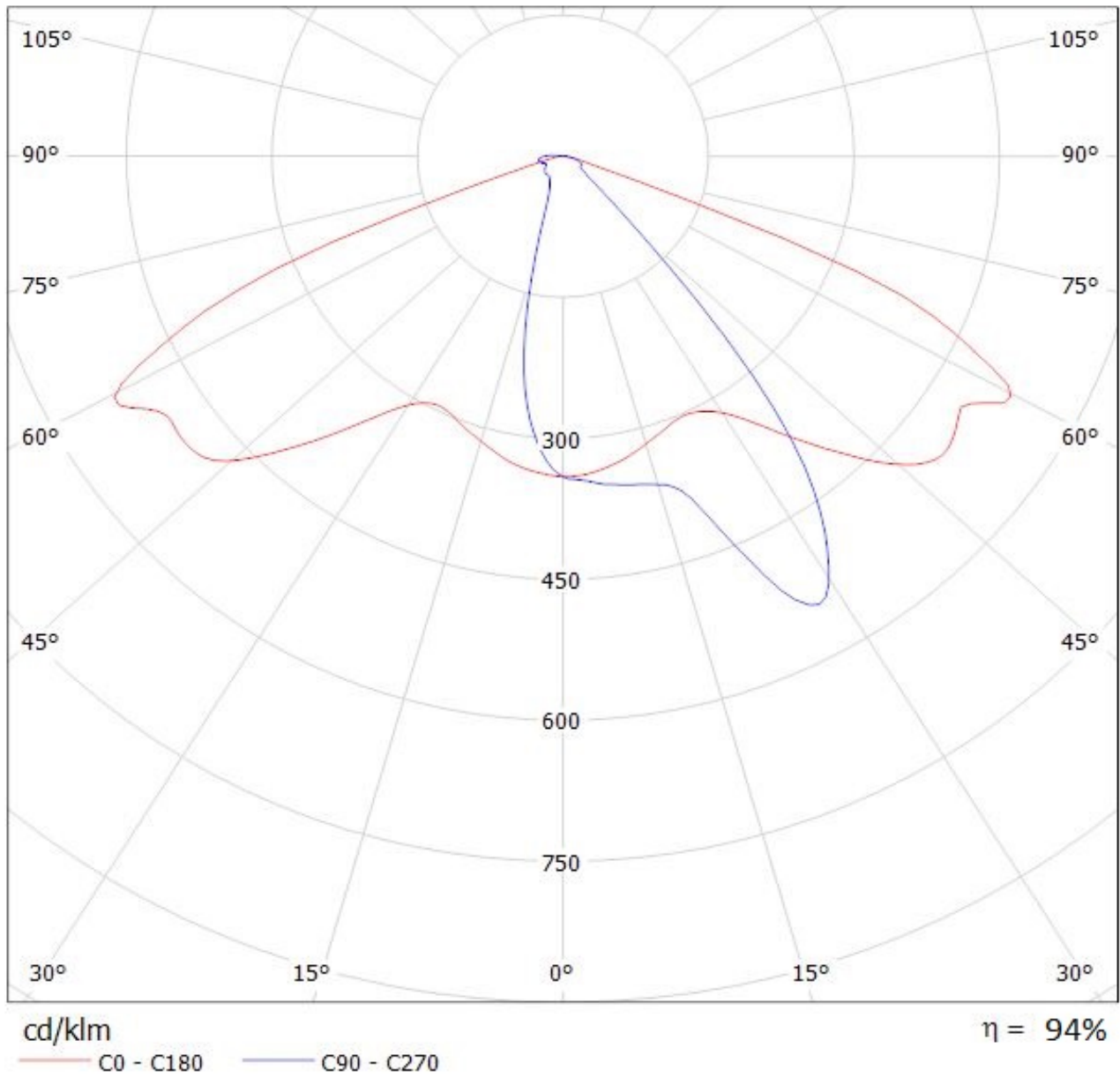

Luminaire: LEDiL Oy C12419_STRADA-2X2-A-T_(Tridonic_Module_RLE_G1)
Lamps: 1 x Tridonic_Module_RLE_G1_2288lm@700mA_P=16W_I=0.700A

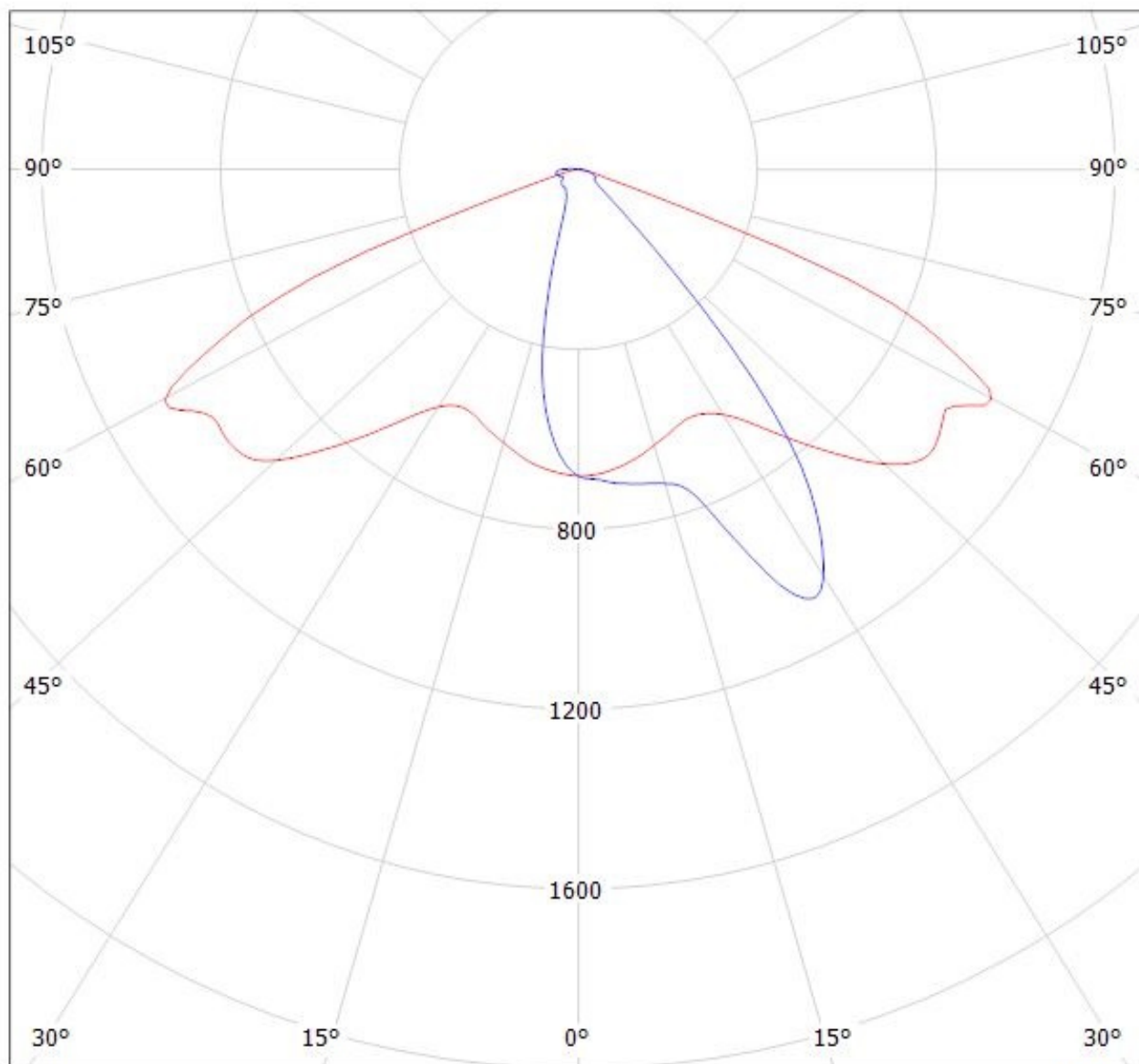

cd/klm

— C0 - C180 — C90 - C270

$\eta = 94\%$

Luminaire: LEDiL Oy C12419_STRADA-2X2-A-T_(Tridonic_Module_RLE_G1)
Lamps: 1 x Tridonic_Module_RLE_G1_2288lm@700mA_P=16W_I=0.700A

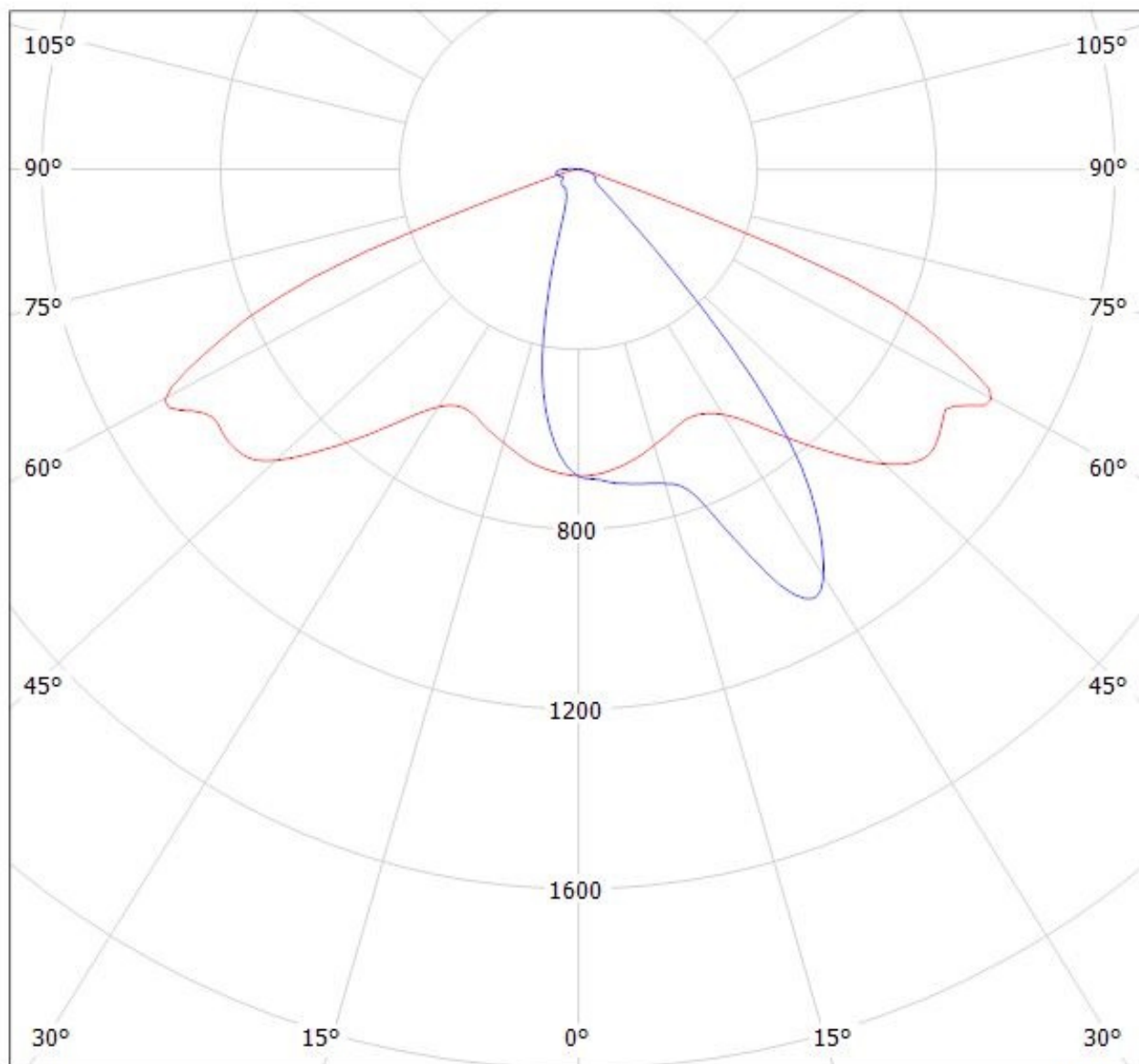

cd/klm

— C0 - C180 — C90 - C270

$\eta = 94\%$

NOTE: The typical divergence will be changed by different color, chip size and chip position tolerance. The typical total divergence is the full angle measured where the luminous intensity is half of the peak value.